

GUHRING

The Tool Company

Full-Line Drill Catalog

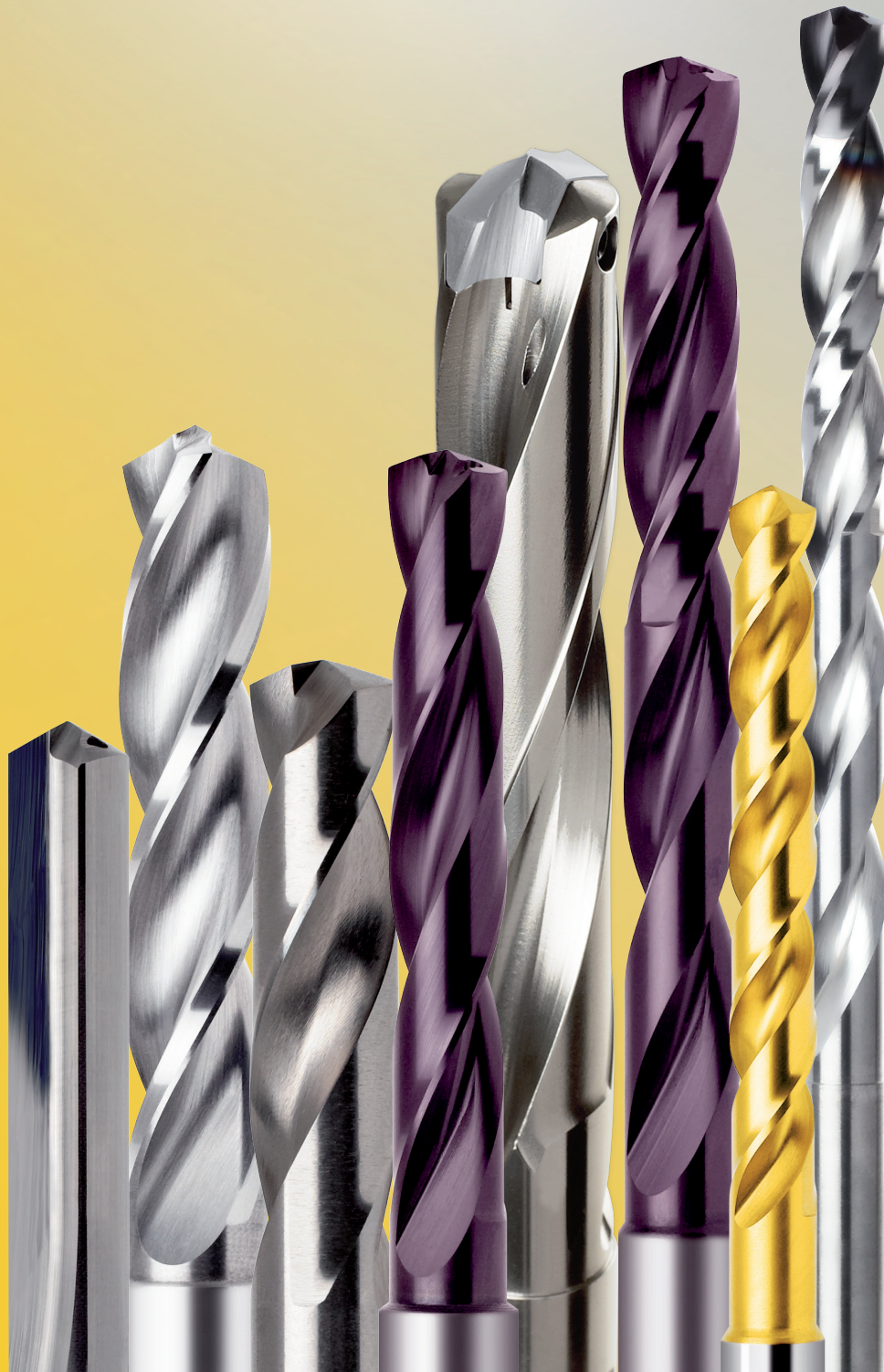

2ND Edition

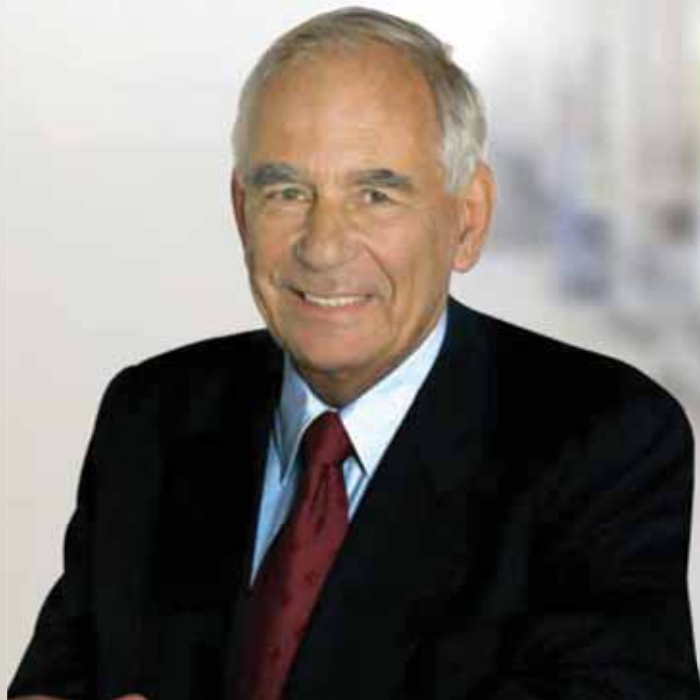

Dr. Jörg Gühring

President,
Research and Development



Oliver Gühring

Sales and Marketing Director

Dear customers,

Highest productivity, excellent economic efficiency and optimum machining results are the principles to which we steer our products and services towards. At Guhring this is achieved with great success by more than of 5,000 employees world-wide. Their objective is customer satisfaction and this makes Guhring the leading world wide manufacturer of rotary cutting tools.

YOU BENEFIT IN MANY WAYS:

Pooled expertise

With Guhring tools you can rely on the tool material, the geometry and the coating – the essential parameters for the efficiency of a precision tool – to be perfectly coordinated. Our own carbide production, our own machine and equipment construction, our own coating technology as well as our own development departments ensure we maintain technological leadership in rotary cutting tools. Within the framework of our special tool production we develop optimized tools with an excellent price-performance-ratio for our customers.



Dietmar Pfränger

Production and Technical
Director



Bernd Schatz

Financial and Commercial
Director

Trend-setting innovations

In excess of 600 granted patents world-wide are proof of our capability for innovation. Countless Guhring standards, as for example, the TiN-coating, the HSK or MQL technology have set trends in the tooling industry.

With the new nano-Si coating – one of the hardest nitride coatings on the market – new tools for the efficient machining of composite materials and highly accurate hydraulic chucks for the clamping of the smallest shank diameters we provide new technologies for the future.

Made-to-measure services

Customer specific tool management concepts combine process planning, logistics, tool application and refurbishment modules together tailor-made to suit your requirements. The new generation of Guhring tool vending systems from the simple workshop solution to the model for complex process chains completes the entire range of tool logistics.

Your partner world-wide

In order for you to benefit from the advantages of our tooling solutions all over the world in close vicinity to your production, Guhring is represented internationally by 28 production plants, 47 service centers, 46 sales companies and countless sales and marketing partners. World-wide our uniform standards ensure that you can always and everywhere rely on the same high Guhring quality.

It would be our pleasure to be allowed to continue to convince you of our efficiency!

Yours sincerely,

Dr. Jörg Gühring

A global company supporting the
global economy



28 production plants
47 service centers
46 sales companies

www.guhring.com

TWIST DRILLS



GUN DRILLS

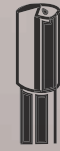

THREADING TOOLS



MILLING CUTTERS



REAMERS



COUNTERSINKS



PCD AND CBN TOOLS



TOOL CLAMPING DEVICES

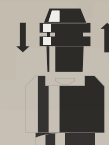

OUR STRENGTHS

Own carbide technology

Own coating technology

Own original equipment, automotive, aerospace and
medical technology centers

Own research and development for tool materials,
geometries and surface finishes

Own service and ongoing support

Own machine-building division

World-wide presence with sales, production, service and
technical field service departments





Always the optimal tool solution at a competitive price

One of the largest standard ranges of rotary cutting tools

Limitless possibilities for made-to-measure special tools

Expert advice regarding optimal tool application

Efficient provision of tool management and logistics

Reconditioning centers in your immediate vicinity

Everything from a reliable single source

YOUR
ADVANTAGES

Quality down to the last detail.



Whether especially high degree of hardness, pronounced bending strength, extreme toughness or extra low reactivity is required – we can produce the perfect carbide grade that exactly matches your individual requirements thanks to our own carbide development and production. For lasting optimized machining results – even with demanding tasks such tapping in steel.

Additionally: We also produce carbide blanks often with a complex geometry as the basis for sophisticated special tools. For example, this includes rods up to a length of 2000 mm or complex blanks with multiple steps as well as rods for multi-fluted tools with up to five spiral coolant ducts.

MADE - TO - MEASURE
QUALITY
FOR MADE - TO - MEASURE
TOOLS.



In short: GUHRING can provide a perfect carbide solution for every industry and every area of application.

Guaranteed perfection for you.

Greater performance.
Longer tool life.

Added value.



A

TiAlN



A a

Super A
nano-A



C

TiCN



Cb

Carbo



D

Crystal



F

FiREX
nano-FiREX



Y

nano-Si



S

TiN

nano-Si COATING

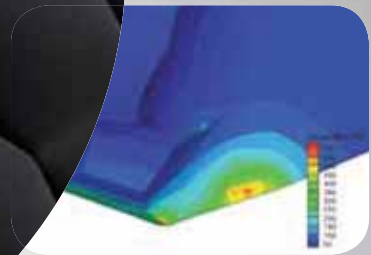

GUHRING is a renowned specialist for application optimized high-performance coatings. As the first tool manufacturer world-wide to provide tools with a TiN-coating in 1980 by continuous improvement we have made them considerably more wear-resistant. To date, GUHRING consistently keeps setting pioneering tooling technology trends. The extremely hard nano-Si coating or the ultra-thin nano-A coating are only a few of the many examples.

Our world-wide service centers work to uniform standards and processes to ensure that our customers' tools can always be re-coated one hundred percent true to the original. Plus: We also coat tooling products from other suppliers as well as functional components from a wide range of industries.

The result: Increased performance and longer tool life.

You too can rely on optimal tool wear protection made by GUHRING.

The think tank for excellent tooling solutions.

Our research and development department is the creative core of the company. Here, trend-setting tooling, machining and technology solutions of the highest accuracy, efficiency and economic efficiency are created. More than 30 years ago the success story of tool coating was originally written. The development of HSK, the introduction of minimal quantity lubrication as well as our innovative machining solutions for composite materials followed.

High-speed camera, scanning electron microscope, thermal imaging camera etc. – the R&D department is excellently equipped and possesses its own testing facility for machining trials that is also available for our customers needs. Including FEM and CFD for the detailed and industry-wide unique process and tool analysis.





Use our know-how
and secure your competitive advantage –
with custom tooling solutions and sophisticated machining strategies
powered by Guhring.

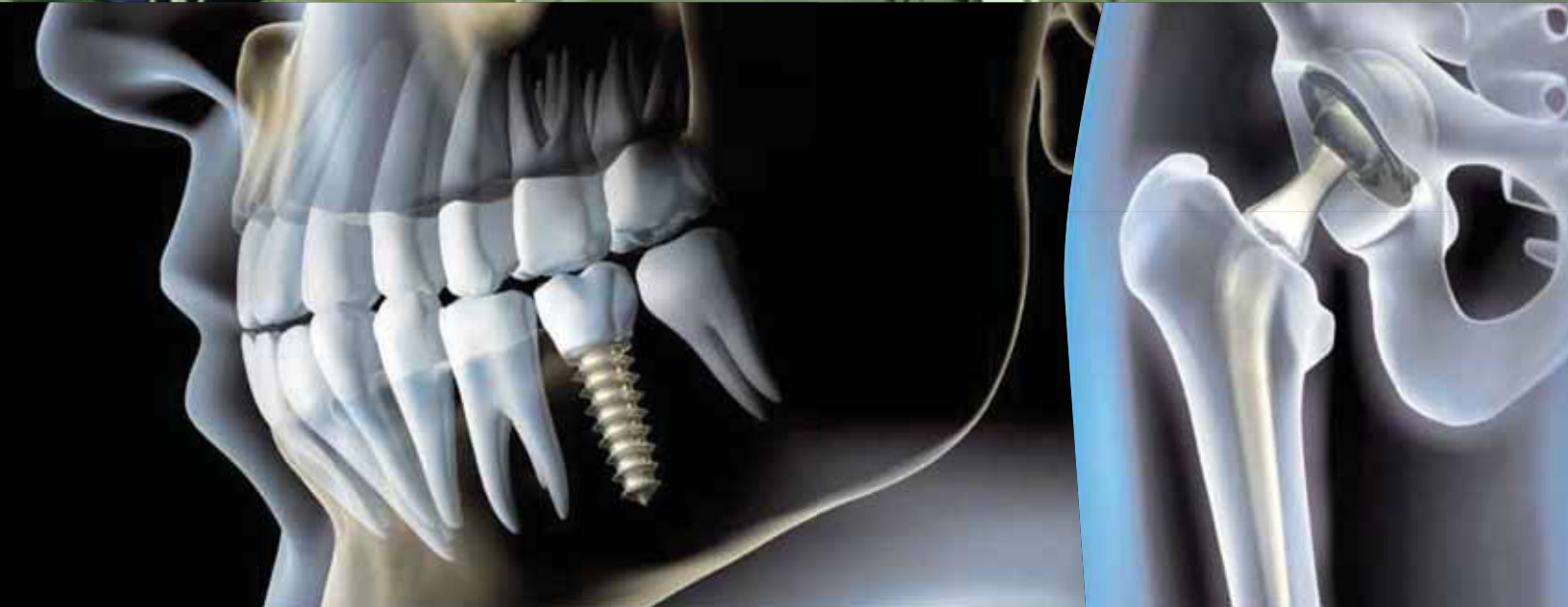

With GUHRING you are guaranteed that you will always be well advised.

Our employees are knowledgeable, well informed and talk from experience –
and dedicated to understand what is important to your business.

For the key sectors machine-building, automotive, aerospace, energy and medical technology
we have the experience and know how.

EYE –TO –EYE LEVEL ADVICE.

From tool and process design via the sales department to the customer support during tool application there are always experienced personnel available. Such wealth of knowledge from our industry-specific tooling and process team is available to you at any time that will offer advice, proposals and solutions together with you and provide production support on your site. For robust, reliable production processes and maximum economic efficiency. Put us to the test!



GUHRING SERVICES



TM 726

TM 526

TM 326



GISS
2000



The component for machining success

GUHRING provides comprehensive services for everything which encompasses tool procurement, management, refurbishment and storage. From complete tool management with tool dispensing systems incorporating our special tool management software to re-grinding, re-coating or contract coating services – the GUHRING service modules can be combined, tailored and perfected to your special individual requirements.

Thanks to our world-wide presence you can benefit from our complete range of services all over the world. We are always in close proximity to you and provide direct on-site support. GUHRING Tool-Management – allows you to concentrate one hundred percent on your actual core business.....your value-generation tasks.





PRODUCTION AND SERVICE CENTERS

GERMANY

Albstadt I
 Albstadt II
 Albstadt III
 Berlin/Precision Tools Production
 Berlin/Carbides
 Geislingen
 Gosheim
 Hörselberg/Eisenach
 Markt Erlbach
 Mindelheim
 Röhrsdorf/Chemnitz
 Saarbrücken
 Sigmaringen-Laiz
 Veldhoven/NL

WORLD-WIDE

Australia
 Brazil
 Brazil
 China
 China
 China
 China
 China
 France
 Great Britain
 India
 India
 India
 Indonesia
 Ireland
 Italy

Diadema
 Joinville
 Changzhou
 Liaoning
 Liuzhou
 Hubei
 Bangalore
 Pune
 Gurgaon

Japan
 Korea
 Korea
 Korea
 Korea
 Korea
 Mexico
 Netherlands
 Austria
 Poland
 Poland
 Rumania
 Russia
 Sweden
 Spain

Chungcheongnam-do
 Rizhao
 Choongnam
 Ulsan City
 Incheon
 Dabrowa Górnicza
 Bielsko Biala

South Africa
 Taiwan
 Thailand
 Czech Republic
 Turkey
 Turkey
 Turkey
 Hungary
 USA
 USA
 USA
 USA
 Vietnam
 Belarus

Istanbul
 Izmir
 Ankara
 Brookfield
 New Hudson
 Huntington Beach
 Bloomfield



SALES COMPANIES ●

Argentina
 Australia
 Baltic States
 Belgium
 Brazil
 Bulgaria
 China
 Denmark
 Finland
 France Alsace
 France Metz-Tessy
 Great Britain
 India
 Indonesia
 Italy
 Japan
 Canada
 Korea
 Malaysia
 Mexico
 Netherlands
 Austria
 Philippines
 Poland
 Rumania
 Russia
 Sweden
 Switzerland
 Singapore
 Slovakia
 Slovenia
 Spain Barcelona
 Spain Madrid
 South Africa



SALES AND MARKETING PARTNERS ●

Taiwan
 Thailand
 Czech Republic
 Turkey
 Ukraine
 Hungary
 USA Brookfield
 USA New Hudson
 Vietnam
 Belarus
 Egypt
 Algeria
 Bolivia
 Chile
 Denmark
 Greece
 Hong Kong
 Italy
 Columbia
 Marocco
 Mauritius
 New Zealand



Norway
 Pakistan
 Peru
 Philippines
 Portugal
 South Africa
 Thailand
 Tunisia
 Venezuela
 Vietnam



Brookfield, WI

For more than 35 years, Guhring Inc. (USA) has brought the innovations of industry-leading Guhring technology, products and technical support to the United States. *One company, one brand, same name* known throughout North America for quality for over three decades.

Guhring is also the leader in tool reconditioning services with the opening of our fourth USA facility in Bloomfield, CT. Combined with our reconditioning and coating facilities in Brookfield, WI; New Hudson, MI; and Huntington Beach, CA, Guhring is the only company that can provide nationwide coverage to support

their customers. Visit www.guhring.com for contact information and request a quotation on-line. It is quick and easy to use and will extend your tool life and increase your productivity.

Need an economical solution?

A category of drills, taps and variable helix carbide end mills called **Guhring Select** tools is for you. These tool series are manufactured from the same materials and to the same quality and exacting tolerances that you expect from Guhring. Each series has been selected because of its versatility in a wide range of materials and machining operations, to provide you with a full compliment of quality drill, tap and milling options at an economical price.

Simplify your tool search by choosing **Guhring Select**. These tools offer a full range of economical, quality, machining solutions. From the production facility to the small prototype machine shop, there is a Guhring Select tool that will suit your needs.

Look for the **Guhring Select** logo to quickly identify these economical tooling choices.

GUHRING Select



CONTENTS

Series no.	Std. range/ page	Feeds & Speeds	Description	Tool Material	Finish
160	70	N/A	For composite mat'ls, high performance, (Type N) screw machine length, 90° point, straight shank, RH	Carbide	Diamond coated
170	70	N/A	For composite mat'ls, (Type N) screw machine length, 90° point, straight shank, RH	Carbide	bright finish
205	71	424	General purpose (Type N), jobber length, 118° point, standard straight shank, RH	HSS	bright/steam oxide >2.36
206	76	424	Low Helix (Type H), jobber length, 118° point, standard straight shank, RH	HSS	bright finish
207	79	425	High Helix (Type W), jobber length, 130° point, standard straight shank, RH	HSS	bright finish
208	82	425	General purpose (Type N), jobber length, 118° point, standard straight shank, RH	HSS	bright/steam oxide >6.00
217	85	426	General purpose (Type N), taper length, 118° point, standard straight shank, RH	HSS	bright/steam oxide >2.36
219	88	426	High Helix (Type W), taper length, 130° point, standard straight shank, RH	HSS	bright finish
223	90	427	General purpose (Type N), stub length, 118° point, standard straight shank, RH	HSS	bright/steam oxide >2.36
224	94	427	Low Helix (Type H), stub length, 118° point, standard straight shank, RH	HSS	bright finish
225	96	428	High Helix (Type W), stub length, 130° point, standard straight shank, RH	HSS	bright finish
226	98	428	General purpose (Type N), stub length, 118° point, standard straight shank, LH	HSS	bright/steam oxide >6.00
235	101	429	General purpose (Type N), extra length #1, 118° point, standard straight shank, RH	HSS	bright/steam oxide >2.36
245	102	429	General purpose (Type N), Standard (MTS), 118° point, Morse Taper shank, RH	HSS	bright/steam oxide >2.36
257	105	430	General purpose (Type N), Bushing (MTS), 118° point, Morse Taper shank, RH	HSS	surface treated
266	106	430	General purpose (Type N), extra length #1, 118° point, Morse Taper shank, RH	HSS	surface treated
280	107	N/A	Form A center drill, Extra long, 60°, non-flatted body, bright finish, RH	HSS	bright finish
281	107	N/A	Form A center drill, 60°, non-flatted body, bright finish, RH	HSS	bright finish
282	107	N/A	Form A center drill, 60°, non-flatted body, bright finish, LH	HSS	bright finish
283	107	N/A	Form R center drill, Radiused, 60°, non-flatted body, bright finish, RH	HSS	bright finish
284	107	N/A	Form R center drill, Radiused, 60°, non-flatted body, bright finish, LH	HSS	bright finish
285	108	N/A	Form B center drill, 60°/120° double angle, non-flatted body, bright finish, RH	HSS	bright finish
287	110	N/A	Form A center drill, 60°, Flatted body, bright finish, RH	HSS	bright finish
288	110	N/A	Form R center drill, Radiused, 60°, Flatted body, bright finish, RH	HSS	bright finish
289	110	N/A	Form B center drill, 60°/120° double angle, Flatted body, bright finish, RH	HSS	bright finish
292	109	N/A	Form A center drill, 60°, non-flatted body, bright finish, RH	HSS	bright finish
294	109	N/A	Form A center drill, 60°, non-flatted body, bright finish, LH	HSS	bright finish
301	111	431	Micro-Precision (Type N), micro-precision, 118° point, reinforced straight shank, RH	Cobalt	bright finish
303	113	431	Micro-Precision (Type N), micro-precision, 118° point, reinforced straight shank, LH	Cobalt	bright finish
305	115	432	General purpose (Type N), jobber length, 118° point, standard straight shank, RH	Cobalt	bright/steam oxide >2.36
308	119	432	General purpose (Type N), jobber length, 118° point, standard straight shank, LH	Cobalt	bright/steam oxide >6.00
317	121	433	General purpose (Type N), taper length, 118° point, standard straight shank, RH	Cobalt	bright/steam oxide >2.36
329	123	433	Heavy Duty (Type GV120), stub length, 130° point, standard straight shank, RH	Cobalt	bright/steam oxide >2.36
336	126	434	GT 100 deep hole, taper length, 130° point, standard straight shank, RH	Cobalt	bright/nitrided lands >2.36
345	128	434	General purpose (Type N), Standard (MTS), 118° point, Morse Taper shank, RH	Cobalt	surface treated
381	107	N/A	Form A center drill, 60°, non-flatted body, bright finish, RH	Cobalt	bright finish
390	129	435	GT 100 IC deep hole, taper length, 130° point, standard straight shank, RH	HSS	bright finish
501	130	435	GT 50 deep hole, taper length, 130° point, standard straight shank, RH	HSS	bright finish
502	132	436	General purpose (Type N), extra length #1, 130° point, standard straight shank, RH	HSS	bright/nitrided lands >2.36
503	134	436	GT 100 deep hole, extra length #2, 130° point, standard straight shank, RH	HSS	bright/nitrided lands >2.36
504	135	437	GT 100 deep hole, extra length #3, 130° point, standard straight shank, RH	HSS	nitrided lands
515	136	437	GT 500 DZ high performance, stub length, 130° cone-relief point, standard straight shank, RH	PM-Cobalt	FIREX® coated
524	138	438	GT 50 deep hole, extra length #1, 130° point, standard straight shank, RH	HSS	bright finish
526	139	438	GT 100 deep hole, extra length #1, 118° point, Morse Taper shank, RH	HSS	nitrided lands/steam oxide >16.0
527	140	439	GT 100 deep hole, extra length #2, 130° point, Morse Taper shank, RH	HSS	nitrided lands/steam oxide >16.0
530	141	439	GT 500 DZ high performance, jobber length, 130° cone relief point, standard straight shank, RH	PM-Cobalt	FIREX® coated
535	143	440	GT 100 deep hole, taper length, 130° point, standard straight shank, RH	HSS	bright/nitrided lands >2.36
546	145	N/A	NC Spot • Short, NC Spot, 142° point, standard straight shank, RH	Carbide	bright finish
549	146	440	GT 100 deep hole, jobber length, 130° point, standard straight shank, RH	HSS	bright/nitrided lands >2.36
550	149	441	GT 100 deep hole, jobber length, 130° point, standard straight shank, LH	HSS	bright/nitrided lands >2.36
551	151	441	GT 100 deep hole, Bushing (MTS), 130° point, Morse Taper shank, RH	HSS	nitrided lands/steam oxide >16.0
552	152	442	GT 80 deep hole, stub length, 130° point, standard straight shank, RH	HSS	<2.36 bright/nitrided lands/steam >16.0
553	155	442	GT 80 deep hole, stub length, 130° point, standard straight shank, LH	HSS	<2.36 bright/nitrided lands/steam >16.1
556	145	N/A	NC Spot • Short, NC Spot, 120° point, standard straight shank, RH	HSS	bright finish
557	145	N/A	NC Spot • Short, NC Spot, 90° point, standard straight shank, RH	HSS	bright finish
559	145	N/A	NC Spot • Long, NC Spot, 90° point, standard straight shank, RH	HSS	bright finish
567	145	N/A	NC Spot • Short, NC Spot, 120° point, standard straight shank, RH	HSS	TiN coated
568	145	N/A	NC Spot • Short, NC Spot, 90° point, standard straight shank, RH	HSS	TiN coated
581	107	N/A	Form A center drill, 60°, non-flatted body, bright finish, RH	HSS	bright finish
582	107	N/A	Form A center drill, 60°, non-flatted body, bright finish, LH	HSS	bright finish

CONTENTS

Series no.	Std. range/ page	Feeds & Speeds	Description	Tool Material	Finish
583	107	N/A	Form R center drill, Radiused, 60°, non-flatted body, bright finish, RH	HSS	bright finish
584	107	N/A	Form R center drill, Radiused, 60°, non-flatted body, bright finish, LH	HSS	bright finish
585	108	N/A	Form B center drill, 60°/120° double angle, non-flatted body, bright finish, RH	HSS	bright finish
586	108	N/A	Form B center drill, 60°, non-flatted body, bright finish, LH	HSS	bright finish
587	110	N/A	Form A center drill, 60°, Flatted body, bright finish, RH	HSS	bright finish
588	110	N/A	Form R center drill, Radiused, 60°, Flatted body, bright finish, RH	HSS	bright finish
589	110	N/A	Form B center drill, 60°/120° double angle, Flatted body, bright finish, RH	HSS	bright finish
590	107	N/A	Form A center drill, Reinforced neck, 60°, non-flatted body, bright finish, RH	HSS	bright finish
591	108	N/A	Form B center drill, Reinforced neck, 60°/120° double angle, non-flatted body, bright finish, RH	HSS	bright finish
594	109	N/A	Form A center drill, 60°, non-flatted body, bright finish, RH	HSS	bright finish
595	109	N/A	Form B center drill, 60°/120° double angle, non-flatted body, bright finish, RH	HSS	bright finish
605	157	443	Heavy Duty Split Point (Type Ti), jobber length, self-centering 130° split point, standard str shank, RH	Cobalt	bright finish
609	160	443	GS 200 U three-flute high precision, 5xD, self-centering 150° point, standard straight shank, RH	Carbide	TiN coated
610	162	444	Heavy Duty Split Point (Type Ti), stub length, self-centering 130° split point, standard str shank, RH	Cobalt	bright finish
613	107	N/A	Form A center drill, 60°, non-flatted body, TiN coated, RH	HSS	TiN coated
614	107	N/A	Form R center drill, 60°, non-flatted body, TiN coated, RH	HSS	TiN coated
617	164	444	Heavy Duty Split Point (Type Ti), taper length, self-centering 130° split point, standard str shank, RH	Cobalt	bright finish
618	166	445	GT 100 deep hole, extra length #1, 130° point, standard straight shank, RH	Cobalt	nitrided lands
619	167	445	GT 100 deep hole, extra length #2, 130° point, standard straight shank, RH	Cobalt	nitrided lands
622	168	446	GT 100 deep hole, jobber length, 130° point, standard straight shank, RH	Cobalt	bright/nitrided lands >2.36
651	170	446	General purpose (Type N), jobber length, 118° point, standard straight shank, RH	HSS	TiN coated
652	174	447	GT 100 deep hole, jobber length, 130° point, standard straight shank, RH	HSS	TiN coated
653	176	447	General purpose (Type N), stub length, 118° point, standard straight shank, RH	HSS	TiN coated
654	179	448	General purpose (Type N), Standard (MTS), 118° point, Morse Taper shank, RH	HSS	TiN coated
657	181	448	Heavy Duty Split Point (Type Ti), jobber length, self-centering 130° split point, standard str shank, RH	Cobalt	TiN coated
658	183	449	GT 100 deep hole, jobber length, 130° point, standard straight shank, RH	Cobalt	TiN coated
659	185	449	Heavy Duty (Type GV120), stub length, 130° point, standard straight shank, RH	Cobalt	TiN coated
660	187	450	Micro-Precision (Type N), micro-precision, 118° point, reinforced straight shank, RH	Cobalt	TiN coated
664	188	450	General purpose (Type N), jobber length, 118° point, standard straight shank, LH	HSS	TiN coated
666	189	451	General purpose (Type N), Bushing length, 118° point, standard straight (tang >3mm) shank, RH	HSS	TiN coated
667	190	451	General purpose (Type N), taper length, 118° point, standard straight shank, RH	HSS	TiN coated
668	192	452	GT 100 deep hole, taper length, 130° point, standard straight shank, RH	HSS	TiN coated
669	194	452	Heavy Duty Split Point (Type Ti), taper length, self-centering 130° split point, standard str shank, RH	Cobalt	TiN coated
670	195	453	GT 100 deep hole, extra length #1, 130° point, standard straight shank, RH	HSS	TiN coated
671	196	453	GT 100 deep hole, extra length #2, 130° point, standard straight shank, RH	HSS	TiN coated
723	145	N/A	NC Spot • Short, NC Spot, 90° point, standard straight shank, RH	Carbide	bright finish
724	145	N/A	NC Spot • Short, NC Spot, 120° point, standard straight shank, RH	Carbide	bright finish
730	197	454	General purpose (Type N), stub length, 118° point, standard straight shank, RH	Carbide	bright finish
732	199	454	General purpose (Type N), jobber length, 118° point, standard straight shank, RH	Carbide	bright finish
736	107	N/A	Form A center drill, 60°, non-flatted body, bright finish, RH	Carbide	bright finish
768	201	455	RT 150 GG straight flute high penetration, 4xD, 120° point, reinforced straight shank, RH	Carbide	bright finish
769	202	455	RT 150 GG straight flute high penetration, 7xD, 120° point, reinforced straight shank, RH	Carbide	bright finish
773	203	456	RT 150 GG straight flute high penetration, 15xD, 120° point, reinforced straight shank, RH	Carbide	bright finish
1047	246	456-457	RT 800 WP Indexable insert, self-centering 140° SF point, RH	Carbide	TiN coated
1131	204	458	GT 80 IC deep hole, jobber length, 130° point, reinforced straight shank, RH	Cobalt	bright finish
1132	205	458	GT 80 IC deep hole, jobber length, 130° point, reinforced straight shank, RH	Cobalt	bright finish
1183	206	459	RT 100 U high penetration, 5xD, self-centering 140° SU point, reinforced str shank w/whistle notch, RH	Carbide	TiN coated
1184	208	459	RT 100 U high penetration, 3xD, self-centering 140° SU point, reinforced str shank w/whistle notch, RH	Carbide	FIREX® coated
1221	210	460	GT 100 deep hole, jobber length, 130° point, standard straight shank, RH	Cobalt	TiCN coated
1223	211	460	GT 100 deep hole, jobber length, 130° point, standard straight shank, RH	Cobalt	TiAlN coated
1242	212	461	RT 100 U high penetration, 3xD, self-centering 140° SU point, standard straight shank, RH	Carbide	TiN coated
1243	214	462	RT 100 U high penetration, 5xD, self-centering 140° SU point, standard straight shank, RH	Carbide	TiN coated
1452	215	462	GS 200 U three-flute high precision, 5xD, self-centering 150° point, standard straight shank, RH	Carbide	bright finish
1662	217	462	RT 100 F high penetration, 5xD, self-centering 140° SF point, reinforced straight shank, RH	Carbide	TiN coated
1702	219	463	RT 100 U high penetration, 3xD, self-centering 140° SU point, standard straight shank, RH	Carbide	TiN coated
2458	220	463	Heavy Duty Split Point (Type Ti), jobber length, self-centering 130° split point, standard str shank, RH	Cobalt	FIREX® coated
2463	222	464	General purpose (Type N), stub length, 118° point, standard straight shank, RH	Carbide	FIREX® coated
2464	224	464	General purpose (Type N), jobber length, 118° point, standard straight shank, RH	Carbide	FIREX® coated
2477	226	465	RT 100 X high penetration, 3xD, self-centering 140° SU point, reinforced straight shank, RH	Carbide	nano-FIREX® coated

CONTENTS

Series no.	Std. range/page	Feeds & Speeds	Description	Tool Material	Finish
2479	228	465	RT 100 X high penetration, 5xD, self-centering 140° SU point, reinforced straight shank, RH	Carbide	nano-FIREX® coated
2485	246	466-467	RT 800 WP Indexable insert, self-centering 140° SF point, RH	Carbide	FIREX® coated
2601	230	467	GT 100 deep hole, jobber length, 130° point, standard straight shank, RH	Carbide	bright finish
2602	231	468	GT 100 deep hole, jobber length, 130° point, standard straight shank, RH	Carbide	TiN coated
2747	246	468-468	RT 800 WP Indexable insert, self-centering 140° SF point, RH	Carbide	bright finish
3899	232	470	Carbide, Micro Drill, 135° 4-facet ground hone point (Type N), reinforced straight shank, RH	Carbide	TiAlN coated
4044	250	479	RT 100 X high penetration, 7xD, self-centering 140° SU point, reinforced straight shank, RH	Carbide	nano-FIREX® coated
4105	245	N/A	HT 800 WP body, coolant through, 1xD w/countersink, straight shank w/whistle notch, RH	HSS	Nickel
4106	240	N/A	HT 800 WP body, coolant through, 1.5xD full-helical flute, straight shank w/whistle notch, RH	HSS	Nickel
4107	240	N/A	HT 800 WP body, coolant through, 3xD full-helical flute, straight shank w/whistle notch, RH	HSS	Nickel
4108	240	N/A	HT 800 WP body, coolant through, 5xD full-helical flute, straight shank w/whistle notch, RH	HSS	Nickel
4109	242	N/A	HT 800 WP body, coolant through, 7xD full-helical flute, straight shank w/whistle notch, RH	HSS	Nickel
4110	242	N/A	HT 800 WP body, coolant through, 10xD full-helical flute, straight shank w/whistle notch, RH	HSS	Nickel
4111	244	N/A	HT 800 WP indexable insert, self-centering 145° SF point, RH	Carbide	nano-A® coated
4112	238	475-478	HT 800 WP indexable insert, self-centering 140° SF point, RH	Carbide	nano-FIREX® coated
4113	238	475-478	HT 800 WP indexable insert, self-centering 140° SF point, RH	Carbide	FIREX® coated
4114	238	464-465	HT 800 WP indexable insert, self-centering 140° SF point, RH	Carbide	bright finish
4115	238	N/A	HT 800 WP indexable insert, self-centering 140° SF point, RH	Carbide	nano-A® coated
5020	252	480	EB 100 straight-flute gun drills, 80mm flute length, type G point point, reinforced straight shank, RH	Carbide	bright finish
5021	252	480	EB 100 straight-flute gun drills, 160mm flute length, type G point point, reinforced straight shank, RH	Carbide	bright finish
5024	252	480	EB 100 straight-flute gun drills, 45mm flute length, type G point point, reinforced straight shank, RH	Carbide	bright finish
5026	252	480	EB 100 straight-flute gun drills, 120mm flute length, type G point point, reinforced straight shank, RH	Carbide	bright finish
5242	248	456	RT 800 WP body, coolant through, 3xD full-helical flute, straight shank w/whistle notch, RH	HSS	Nickel
5243	248	457	RT 800 WP body, coolant through, 5xD full-helical flute, straight shank w/whistle notch, RH	HSS	Nickel
5248	248	457	RT 800 WP body, coolant through, 7xD full-helical flute, straight shank w/whistle notch, RH	HSS	Nickel
5510	253	481	RT 100 U high penetration, 3xD, self-centering 140° SU point, reinforced straight shank, RH	Carbide	FIREX® coated
5511	255	481	RT 100 U high penetration, 5xD, self-centering 140° SU point, reinforced straight shank, RH	Carbide	FIREX® coated
5512	257	482	RT 100 U high penetration, 7xD, self-centering 140° SU point, reinforced straight shank, RH	Carbide	FIREX® coated
5513	259	482	RT 150 GG straight flute high penetration, 10xD, 120° point, reinforced straight shank, RH	Carbide	bright finish
5514	260	483	RT 100 U high penetration, 3xD, self-centering 140° SU point, reinforced straight shank, RH	Carbide	FIREX® coated
5515	262	483	RT 100 U high penetration, 5xD, self-centering 140° SU point, reinforced straight shank, RH	Carbide	FIREX® coated
5518	264	484	GS 200 G three-flute high precision, 5xD, self-centering 130° point, reinforced straight shank, RH	Carbide	bright finish
5519	265	484	GU 500 DZ universal, jobber length, 118° 4-facet split point, standard straight shank, RH	Cobalt	TiN coated
5520	267	485	GU 500 DZ universal, stub length, 118° 4-facet split point, standard straight shank, RH	Cobalt	TiN coated
5521	269	485	GT 500 DZ high performance, stub length, 130° cone-relief point, standard straight shank, RH	PM-Cobalt	TiN coated
5522	271	486	GT 500 DZ high performance, jobber length, 130° cone relief point, standard straight shank, RH	PM-Cobalt	TiN coated
5523	273	486	GU 500 DZ universal, jobber length, 118° 4-facet split point, standard straight shank, RH	Cobalt	bright finish
5524	275	487	GU 500 DZ universal, stub length, 118° 4-facet split point, standard straight shank, RH	Cobalt	bright finish
5525	277	487	RT 100 C high penetration, 12xD, self-centering 135° SC, double margins point, reinforced str shank, RH	Carbide	FIREX® coated
5536	279	488	GU 500 DZ universal, 10xD, 118° 4-facet split point, standard straight shank, RH	Cobalt	bright finish
5537	281	488	GU 500 DZ universal, 10xD, 118° 4-facet split point, standard straight shank, RH	Cobalt	TiN coated
5610	283	489	RT 100 U high penetration, 3xD, self-centering 140° SU point, reinforced shank w/whistle notch, RH	Carbide	FIREX® coated
5611	285	489	RT 100 U high penetration, 5xD, self-centering 140° SU point, reinforced shank w/whistle notch, RH	Carbide	FIREX® coated
5612	287	490	RT 100 U high penetration, 7xD, self-centering 140° SU point, reinforced shank w/whistle notch, RH	Carbide	FIREX® coated
5641	288	490	EB 80, Single flute gun drill, 40xD, type G point, standard driver, reinforced straight shank, RH	Carbide	TiCN coated
5642	288	491	EB 80, Single flute gun drill, 80xD, type G point, standard driver, reinforced straight shank, RH	Carbide	TiCN coated
5646	289	491	EB 100, Single flute gun drill, 25xD, type G point, standard driver, reinforced straight shank, RH	Carbide	nano-A™ coated
5647	289	492	EB 100, Single flute gun drill, 50xD, type G point, standard driver, reinforced straight shank, RH	Carbide	nano-A™ coated
5648	289	492	EB 100, Single flute gun drill, 75xD, type G point, standard driver, reinforced straight shank, RH	Carbide	nano-A™ coated
5741	290	493	RT 100 US high penetration, 3xD, self-centering 140° SU point, reinforced straight shank, RH	Carbide	nano-A™ coated
5744	292	493	RT 100 US high penetration, 5xD, self-centering 140° SU point, reinforced straight shank, RH	Carbide	nano-A™ coated
5746	294	494	RT 100 US high penetration, 7xD, self-centering 140° SU point, reinforced straight shank, RH	Carbide	nano-A™ coated
6068	295	494	RT 150 GG straight flute high penetration, 4xD, 130° point, reinforced straight shank, RH	Carbide	bright finish
6069	296	495	RT 150 GG straight flute high penetration, 7xD, 130° point, reinforced straight shank, RH	Carbide	bright finish
6070	297	495	RT 150 GG straight flute high penetration, 10xD, 130° point, reinforced straight shank, RH	Carbide	bright finish
6400	298	496	Exclusive Line Micro Drills, 4xD, 140° 4-facet ground hone point, reinforced straight shank, RH	Carbide	Super-A™ coated
6401	298	496	Exclusive Line Micro Drills, 7xD, 140° 4-facet ground hone point, reinforced straight shank, RH	Carbide	Super-A™ coated
6405	299	497	Exclusive Line Micro Drills, 5xD, 135° 4-facet ground hone point, reinforced straight shank, RH	Carbide	TiAlN coated
6408	300	497	Exclusive Line Micro Drills, 8xD, 135° 4-facet ground hone point, reinforced straight shank, RH	Carbide	TiAlN coated

CONTENTS

Series no.	Std. range/ page	Feeds & Speeds	Description	Tool Material	Finish
6412	300	497	Exclusive Line Micro Drills, 15xD, 135° 4-facet ground hone point, reinforced straight shank, RH	Carbide	TiAIN coated
6501	301	498	RT 100 R high penetration, 5xD, radius point point, reinforced straight shank, RH	Carbide	FIREX® coated
6502	303	498	RT 100 R high penetration, 7xD, radius point point, reinforced straight shank, RH	Carbide	FIREX® coated
6509	305	499	RT 100 T high penetration, extra length, 135° point, standard straight shank, RH	Carbide	TiAIN tipped
6511	305	499	RT 100 T high penetration, 20xD, 135° point, standard straight shank, RH	Carbide	TiAIN tipped
6512	306	499	RT 100 T high penetration, 25xD, 135° point, standard straight shank, RH	Carbide	TiAIN tipped
6513	306	500	RT 100 T high penetration, 30xD, 135° point, standard straight shank, RH	Carbide	TiAIN tipped
6514	306	500	RT 100 T high penetration, 40xD, 135° point, standard straight shank, RH	Carbide	TiAIN tipped
8510	307	501	RT 100 VA high penetration, 3xD, self-centering 140° VA point, reinforced straight shank, RH	Carbide	nano-A™ coated
8511	309	501	RT 100 VA high penetration, 5xD, self-centering 140° VA point, reinforced straight shank, RH	Carbide	nano-A™ coated
8520	311	502	RT 100 HF high penetration, 3xD, self-centering 140° HF point, reinforced straight shank, RH	Carbide	nano-Si™ coated
8521	313	502	RT 100 HF high penetration, 5xD, self-centering 140° HF point, reinforced straight shank, RH	Carbide	nano-Si™ coated
8522	315	503	RT 100 HF high penetration, 7xD, self-centering 140° HF point, reinforced straight shank, RH	Carbide	nano-Si™ coated
8524	316	503	RT 100 HF high penetration, 3xD, self-centering 140° HF point, reinforced straight shank, RH	Carbide	nano-Si™ coated
20042	321	N/A	Hollfelder, Drill/Chamfer unit for hydraulic chucks	N/A	N/A
20067	321	N/A	Hollfelder, Drill/Chamfer clamping set	N/A	N/A
20362	322	N/A	Hollfelder, K10 carbide insert	Carbide	bright finish
20363	322	N/A	Hollfelder, G12 / K10 carbide insert	Carbide	TiAIN coated
20364	322	N/A	Hollfelder, G16 / P20 carbide insert	Carbide	TiAIN coated
20365	322	N/A	Hollfelder, PCD insert	PCD	bright finish

Packaging Details

Tool group	Standard	Units per package
Straight shank HSS twist drills	DIN 338 DIN 1897 and similar Guhring standards	Ø 7.50 mm packed in units of 10 Ø 7.50 ... Ø 10.60 mm packed in units of 5* Ø 10.60 mm 1 unit per package
	DIN 339 DIN 340 and similar Guhring standards	Ø 6.70 mm packed in units of 10 Ø 6.70 ... Ø 10.60 mm packed in units of 5 Ø 10.60 mm 1 unit per package
	DIN 1869	Ø 7.50 mm packed in units of 10 Ø 7.50 ... Ø 10.60 mm packed in units of 5 Ø 10.60 mm 1 unit per package
Taper shank HSS twist drills	all DIN-standards and Guhring-standards	all sizes supplied 1 unit per package
Carbide and carbide tipped twist drills	all DIN-standards and Guhring-standards	Ø 2.00 mm packed in units of 10 Ø 2.00 mm 1 unit per package
Micro-precision drills	DIN 1899	all sizes supplied packed in units of 10
Metric center drills	DIN 333 form A, form R	Ø 4.00 mm packed in units of 10 Ø 4.00 mm 1 unit per package
	DIN 333 form B	Ø 2.50 mm packed in units of 10 Ø 2.50 mm 1 unit per package

*coated tools packed in units of 10

Tool group	Standard	Units per package
HSS machine taps and fluteless machine taps	DIN 371 DIN 376 DIN 374 DIN 2174 DIN 2184	all sizes supplied 1 unit per package

Tool group	Standard	Units per package
Milling cutters and reamers all tool materials	all DIN-standards and Guhring-standards	all sizes supplied 1 unit per package

Visit

WWW.GUHRING.com

Guhring Navigator:

Guhring Navigator is a step by step program that allows you to find the perfect Guhring tool for your machining task.

Guhring Navigator allows you to specify the material you are cutting and tool features you desire. The ending search result displays the ideal tool(s), speeds and feeds as well as other key information.

Stop flipping through a catalog to find the right tool and let Guhring Navigator do the work for you!



GUHRING

E-Learning

Product Info
Videos
How To's

Product Demos
Tutorials
Catalog Info

Everything you need to know about Guhring products,
and more.

High Performance CARBIDE DRILLS

GUHRING
Select



GUHRING
Select



GUHRING
Select



SERIES	730	2463	1702	1242	1184	5514	5741	8524	8510	5510	5610	2477	8520
Style	Type N	Type N	RT 100 F	RT 100 U	RT 100 U	RT 100 U	RT 100 US	RT 100 HF	RT 100 VA	RT 100 U	RT 100 U	RT 100 "X"	RT 100 HF
Point Angle	118°	118°	140°	140°	140°	140°	140°	140°	140°	140°	140°	140°	140°
Length	3 x D	3 x D	3 x D	3 x D	3 x D	3 x D	3 x D	3 x D	3 x D	3 x D	3 x D	3 x D	3 x D
Shank													
Coolant													
Carbide Grade	DK120	DK120	DK460UF	DK460UF	DK460UF	DK460UF	DK460UF	DK460UF	DK460UF	DK460UF	DK460UF	DK460UF	DK460UF
Surface Finish													
Std. Dia. Range mm	0.50- 16.00	1.00-16.00	3.00- 15.00	3.00- 16.00	3.00- 20.00	3.00- 20.00	3.00- 12.70	3.00- 20.00	3.00-20.00	3.00- 20.00	3.00-20.00	3.00- 20.00	3.00- 20.00
Std. Dia. Range In.	0.0197- 0.6299	0.0394- 0.6299	0.1181- 0.5906	0.1181- 0.6299	0.1181- 0.7874	0.1181- 0.7874	0.1181- 0.5000	0.1181- 0.7874	0.1181- 0.7874	0.1181- 0.7874	0.1181- 0.7874	0.1181- 0.7874	0.1181- 0.7874
Catalog Page	197	222	219	212	208	260	290	316	307	253	283	226	311
Tech Data Page	454	464	463	461	459	483	493	503	501	481	489	465	502

GUHRING
Select



SERIES	5512	5612	4044	6502	5746	8522	2601	2602	5525
Style	RT 100 U	RT 100 U	RT 100 "X"	RT 100 R	RT 100 US	RT 100 HF	GT 100	GT 100	RT 100 C
Point Angle	140°	140°	140°	Special	140°	140°	130°	130°	140°
Length	7 x D	7 x D	7 x D	7 x D	7 x D	7 x D	8 x D	8 x D	12 x D
Shank									
Coolant									
Carbide Grade	DK460UF	DK460UF	DK460UF	DK255F	DK460UF	DK460UF	DK460UF	DK460UF	DK460UF
Surface Finish									
Std. Dia. Range mm	3.00- 20.00	3.00- 20.00	3.00- 20.00	3.00- 20.00	4.00- 12.70	3.00- 16.00	3.17- 12.70	3.17- 12.70	3.00- 20.00
Std. Dia. Range In.	0.1181- 0.7874	0.1181- 0.7874	0.1181- 0.7874	0.1181- 0.7874	0.1181- 0.5000	0.1181- 0.6299	0.1248- 0.5000	0.1248- 0.5000	0.1181- 0.7874
Catalog Page	257	287	250	303	294	315	230	231	277
Tech Data Page	482	490	479	498	494	503	467	468	487

SERIES	GUHRING Select		GUHRING Select				GUHRING Select						
	732	2464	1243	5515	1662	1183	8511	5511	5611	2479	5744	8521	6501
Style	Type N	Type N	RT 100 U	RT 100 U	RT 100 F	RT 100 U	RT 100 VA	RT 100 U	RT 100 U	RT 100 "X"	RT 100 US	RT 100 HF	RT 100 R
Point Angle	118°	118°	140°	140°	140°	140°	140°	140°	140°	140°	140°	140°	140°
Length	5 x D	5 x D	5 x D	5 x D	5 x D	5 x D	5 x D	5 x D	5 x D	5 x D	5 x D	5 x D	5 x D
Shank													
Coolant													
Carbide Grade	DK120	DK120	DK460UF	DK460UF	DK460UF	DK460UF	DK460UF	DK460UF	DK460UF	DK460UF	DK460UF	DK460UF	DK255F
Surface Finish	○	Ⓡ	Ⓢ	Ⓡ	Ⓢ	Ⓢ	Ⓡ	Ⓡ	Ⓡ	Ⓝ	Ⓡ	Ⓡ	Ⓡ
Std. Dia. Range mm	1.00- 12.70	1.00- 12.70	5.00- 16.00	3.00- 20.00	3.00- 20.00	3.00- 20.00	3.00-20.00	3.00- 20.00	3.00- 20.00	3.00- 20.00	3.00- 12.70	3.00- 20.00	3.00- 20.00
Std. Dia. Range In.	0.0394- 0.5000	0.0394- 0.5000	0.1969- 0.6299	0.1181- 0.7874	0.1181 - 0.7874	0.1181 - 0.7874	0.1181- 0.7874	0.1181- 0.7874	0.1181- 0.7874	0.1181- 0.7874	0.1181- 0.5000	0.1181- 0.7874	0.1181- 0.7874
Catalog Page	199	224	214	262	217	206	309	255	285	228	292	313	301
Tech Data Page	454	464	461	483	462	459	501	481	489	465	493	502	498

SERIES	GUHRING Select						GUHRING Select			GUHRING Select		
	3899	6400	6405	6401	6408	6412	1452	609	5518	723	724	546
Style	Micro Drill	Micro Drill	Micro Drill	Micro Drill	Micro Drill	Micro Drill	GS 200 U	GS 200 U	GS 200 G	90° Spot	120° Spot	142° Spot
Point Angle	140°	140°	140°	140°	135°	135°	150°	150°	130°	90°	120°	142°
Length	5 x D	4 x D	5 x D	7 x D	8 x D	15 x D	5 x D	5 x D	5 x D	Short	Short	Short
Shank												
Coolant												
Carbide Grade	DK460UF	DK460UF	DK460UF	DK460UF	DK460UF	DK460UF	DK460UF	DK460UF	DK460UF	DK120	DK120	DK120
Surface Finish	Ⓡ	Ⓡ	Ⓡ	Ⓡ	Ⓡ	Ⓡ	○	Ⓢ	○	○	○	○
Std. Dia. Range mm	0.10-3.00	0.50- 3.00	1.40-3.00	0.50- 3.00	1.40-3.00	1.40-3.00	3.00- 20.00	3.00- 20.00	3.00- 20.00	4.00- 20.00	5.00- 20.00	4.00- 20.00
Std. Dia. Range In.	0.0039- 0.0472	0.0197- 0.1181	0.0197- 0.1181	0.0197- 0.1181	0.0551- 0.1181	0.0551- 0.1181	0.1181- 0.6248	0.1181- 0.7874	0.1181- 0.7874	0.1575- 0.7874	0.1969- 0.7874	0.1575- 0.7874
Catalog Page	232	298	299	298	300	300	215	160	264	145	145	145
Tech Data Page	470	496	497	496	497	497	462	443	484	N/A	N/A	N/A

Straight Flute Drills



SERIES	768	6068	769	6069	5513	6070	773
Style	RT 150 GG	RT 150 GG	RT 150 GG	RT 150 GG	RT 150 GG	RT 150 GG	RT 150 GN
Point Angle	120°	130°	120°	130°	120°	130°	120°
Length	4 x D	4 x D	7 x D	7 x D	10 x D	10 x D	15 x D
Shank							
Coolant							
Carbide Grade	DK460UF	DK255F	DK460UF	DK255F	DK460UF	DK255F	DK460UF
Surface Finish							
Std. Dia. Range mm	3.00- 20.00	3.00- 20.00	3.00- 20.00	3.00- 20.00	3.00- 16.00	3.00- 20.00	5.00- 14.00
Std. Dia. Range In.	0.1181- 0.7874	0.1181- 0.7874	0.1181- 0.7874	0.1181- 0.7874	0.1181- 0.6299	0.1181- 0.7874	0.1969- 0.5512
Catalog Page	201	295	202	296	259	297	203
Tech Data Page	441	494	455	495	482	495	456

Deep Hole Drills



SERIES	6509	6511	6512	6513	6514
Style	RT 100 T	RT 100 T	RT 100 T	RT 100 T	RT 100 T
Point Angle	135°	135°	135°	135°	135°
Length	15 x D	20 x D	25 x D	30 x D	40 x D
Shank					
Coolant					
Carbide Grade	DK460UF	DK460UF	DK460UF	DK460UF	DK460UF
Surface Finish					
Std. Dia. Range mm	3.00- 14.00	3.00- 14.00	3.00- 12.00	3.00- 10.00	3.00- 8.00
Std. Dia. Range In.	0.1181- 0.5512	0.1181- 0.5512	0.1181- 0.4724	0.1181- 0.3937	0.1181- 0.3150
Catalog Page	305	305	306	306	306
Tech Data Page	499	499	499	500	500

RT100 T drills are coolant fed, sub-micro grain carbide high penetration rate drills designed to run faster with higher production rates. RT100 T drills require a pilot hole for guidance but then drill without a peck cycle. Designed for CNC machining centers, these high-performance drills can eliminate gun drills in many applications.

Gun Drills











SERIES	5641	5642	5024	5020	5026	5021	5646	5647	5648
Style	EB80	EB80	EB100	EB100	EB100	EB100	EB100	EB100	EB100
Point Angle	Special	Special	Special	Special	Special	Special	Special	Special	Special
Length	40 x D	80 x D	45mm FL	80mm FL	120mm FL	160mm FL	25 x D	50 x D	75 x D
Shank									
Coolant									
Carbide Grade	DK460UF	DK460UF	DK460UF	DK460UF	DK460UF	DK460UF	DK460UF	DK460UF	DK460UF
Surface Finish	TICN	TICN	○	○	○	○	A	A	A
Std. Dia. Range mm	3.97-12.70	4.95 - 12.65	1.20- 3.20	1.20- 5.00	1.50- 5.00	1.50- 8.00	1.00-12.00	1.00-8.00	1.00-6.00
Std. Dia. Range In.	1.5630-5.000	0.1949-0.4980	0.0472-0.1260	0.0472-0.1969	0.0591-0.1969	0.0591-0.1969	0.0394-0.4724	0.0394-0.3150	0.0394-0.2362
Catalog Page	288	288	252	252	252	252	289	289	289
Tech Data Page	490	491	480	480	480	480	491	491	491



RT 800 WP Inserts and Holders



Three RT 800 WP Inserts (2747, 1047, 2485) and three RT 800 WP Holders (5242, 5243, 5248) are shown above the table.

SERIES	2747	1047	2485	5242	5243	5248
Style	RT 800 WP Insert	RT 800 WP Insert	RT 800 WP Insert	RT 800 WP Holder	RT 800 WP Holder	RT 800 WP Holder
Point Angle	140°	140°	140°	N/A	N/A	N/A
Length	N/A	N/A	N/A	3 x D	5 x D	7 x D
Shank	N/A	N/A	N/A			
Coolant						
Carbide Grade	DK460UF	DK460UF	DK460UF	HSS	HSS	HSS
Surface Finish				Nickel	Nickel	Nickel
Std. Dia. Range mm	16.00- 40.50	16.00- 40.50	16.00- 40.50	N/A	N/A	N/A
Std. Dia. Range In.	0.6299- 1.5945	0.6299- 1.5945	0.6299- 1.5945	N/A	N/A	N/A
Catalog Page	246	246	246	248	248	248
Tech Data Page	468-469	456-457	466-467	N/A	N/A	N/A

HT 800 WP Inserts



Five HT 800 WP Inserts (4111, 4112, 4113, 4114, 4115) are shown above the table.

SERIES	4111	4112	4113	4114	4115
Style	HT 800 WP Insert	HT 800 WP Insert	HT 800 WP Insert	HT 800 WP Insert	HT 800 WP Insert
Point Angle	145°	140°	140°	140°	140°
Length	N/A	N/A	N/A	N/A	N/A
Shank	N/A	N/A	N/A	N/A	N/A
Coolant					
Carbide Grade	DK460UF	DK460UF	DK460UF	DK460UF	DK460UF
Surface Finish					
Std. Dia. Range mm	11.00- 25.50	11.00- 25.50	11.00- 25.50	11.00- 25.50	11.00- 25.50
Std. Dia. Range In.	0.4331- 1.0039	0.4331- 1.0039	0.4331- 1.0039	0.4331- 1.0039	0.4331- 1.0039
Catalog Page	244	238	238	238	238
Tech Data Page	N/A	475-478	475-478	475-478	475-478

Advantages of the HT 800 WP design:

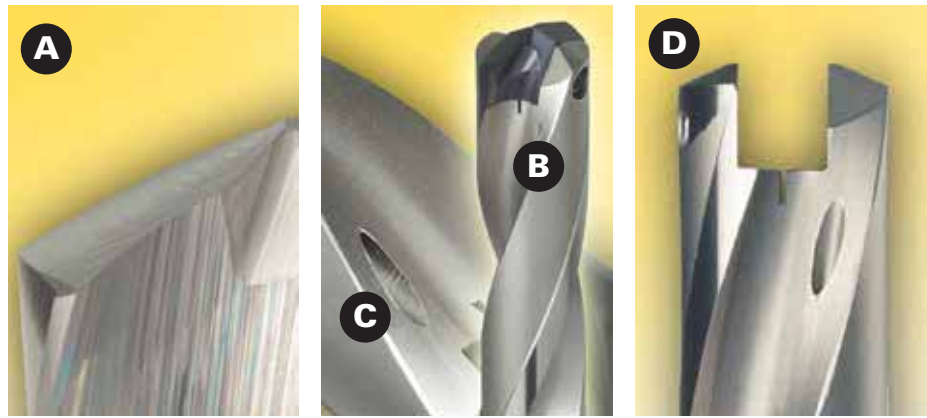

- A Extended tool life**
Thanks to special micro-machined cutting edges and the application oriented coatings, the interchangeable inserts of the HT 800 WP drilling system are especially wear resistant. The bodies of the HT 800 WP drilling system also possess extremely high wear resistance thanks to the optimized body material with nickel plated surface. The incremental holder sizes in steps of 0.5 mm also leads to less wear on the body.
- B Optimized chip flow**
Thanks to their flute cross section the bodies of the HT 800 WP drilling system ensure optimal chip evacuation from the hole, even in deep-hole applications.
- C Superior coolant delivery**
Delivery of coolant is ensured by coolant ducts with maximum cross section, exiting in the flutes. This enables optimal coolant flow to the the cutting edges, further improving the chip evacuation from the hole.
- D Highly accurate and rigid insert seat**
The accurate insert seat enables indexing in the machine in only a few simple steps, with a standard Torx screw driver. The tough material of the HT 800 WP bodies allows the insert to be changed more frequently than with conventional systems, due to reduced wear of the insert seat. The clamping screws with screw lock ensure a secure holding of the interchangeable insert in the body, even with machines subject to high levels of vibrations.

HT 800 WP Holders



SERIES	4105	4106	4107	4108	4109	4110
Style	HT 800 WP Holder	HT 800 WP Holder	HT 800 WP Holder	HT 800 WP Holder	HT 800 WP Holder	HT 800 WP Holder
Point Angle	N/A	N/A	N/A	N/A	N/A	N/A
Length	Pilot	1.5 x D	3 x D	5 x D	7 x D	10 x D
Shank						
Coolant						
Carbide Grade	HSS	HSS	HSS	HSS	HSS	HSS
Surface Finish	Nickel	Nickel	Nickel	Nickel	Nickel	Nickel
Std. Dia. Range mm	N/A	N/A	N/A	N/A	N/A	N/A
Std. Dia. Range In.	N/A	N/A	N/A	N/A	N/A	N/A
Catalog Page	245	240	240	240	242	242
Tech Data Page	N/A	N/A	475	476	477	478

HSS / Cobalt Drills

Jobber Length Drills



SERIES	205	208	651	664	206	207	549	550	652	305	308	605	657	2458
Style	N	N (LH)	N	N (LH)	H	W	GT100	GT100(LH)	GT100	N	N (LH)	Ti	Ti	Ti
Point Angle	118°	118°	118°	118°	118°	130°	130°	130°	130°	118°	118°	130°	130°	130°
Length	Jobber	Jobber	Jobber	Jobber	Jobber	Jobber	Jobber	Jobber	Jobber	Jobber	Jobber	Jobber	Jobber	Jobber
Shank														
Coolant														
Substrate	HSS	HSS	HSS	HSS	HSS	HSS	HSS	HSS	HSS	Cobalt	Cobalt	Cobalt	Cobalt	Cobalt
Surface Finish														
Std. Dia. Range mm	0.200 - 20.000	0.240 - 16.000	0.200 - 19.000	0.400 - 10.200	0.200 - 20.000	0.200 - 20.000	0.600 - 16.000	1.000 - 12.700	1.000 - 16.000	0.200 - 20.000	0.480 - 12.700	0.300 - 19.050	0.500 - 13.000	0.400 - 15.000
Std. Dia. Range In.	0.0079 - 0.7874	0.0094 - 0.6299	0.0079 - 0.7480	0.0157 - 0.4016	0.0079 - 0.7874	0.0079 - 0.7874	0.0236 - 0.6299	0.0394 - 0.5000	0.0394 - 0.6299	0.0079 - 0.7874	0.0189 - 0.5000	0.0118 - 0.7500	0.0197 - 0.5118	0.0157 - 0.5906
Catalog Page	71	82	170	188	76	79	146	149	174	115	119	157	181	220
Tech Data Page	424	425	446	450	424	425	440	441	447	432	432	443	448	463

Stub Length Drills



SERIES	223	226	653	224	225	552	553	329	610	659	5524	5520	5521	515
Style	N	N (LH)	N	H	W	GT80	GT80 (LH)	GV120	Ti	GV120	GU500DZ	GU500DZ	GT500DZ	GT500DZ
Point Angle	118°	118°	118°	118°	130°	130°	130°	130°	130°	130°	118°	118°	130°	130°
Length	Stub	Stub	Stub	Stub	Stub	Stub	Stub	Stub	Stub	Stub	Stub	Stub	Stub	Stub
Shank														
Coolant														
Substrate	HSS	HSS	HSS	HSS	HSS	HSS	HSS	Cobalt	Cobalt	Cobalt	Cobalt	Cobalt	PM-Cobalt	PM-Cobalt
Surface Finish														
Std. Dia. Range mm	0.400 - 31.750	0.500 - 44.450	0.500 - 28.500	0.900 - 22.000	1.000 - 20.000	1.000 - 20.000	1.000 - 20.000	0.400 - 25.400	1.000 - 14.290	0.500 - 15.500	1.000 - 14.290	1.000 - 14.290	1.000 - 14.000	1.000 - 14.290
Std. Dia. Range In.	0.0157 - 1.2500	0.0197 - 1.7500	0.0197 - 1.1220	0.0354 - 0.8661	0.0394 - 0.7874	0.0394 - 0.7874	0.0394 - 0.7874	0.0157 - 1.0000	0.0394 - 0.5626	0.0197 - 0.6102	0.0394 - 0.5626	0.0394 - 0.5626	0.0394 - 0.5512	0.0394 - 0.5626
Catalog Page	90	98	176	94	96	152	155	123	162	185	275	267	269	136
Tech Data Page	427	428	447	427	428	442	442	433	444	449	487	485	485	437



bright



steam oxide



nitrided lands



nitrided



TiN

GUHRING
Select

GUHRING
Select

Jobber Length Drills



SERIES	1131	1132	622	658	1221	1223	5523	5519	5522	530
Style	GT80	GT80	GT100	GT100	GT100	GT100	GU500DZ	GU500DZ	GT500DZ	GT500DZ
Point Angle	130°	130°	130°	130°	130°	130°	118°	118°	130°	130°
Length	Jobber	Jobber	Jobber	Jobber	Jobber	Jobber	Jobber	Jobber	Jobber	Jobber
Shank										
Coolant										
Substrate	Cobalt	Cobalt	Cobalt	Cobalt	Cobalt	Cobalt	Cobalt	Cobalt	PM-Cobalt	PM-Cobalt
Surface Finish										
Std. Dia. Range mm	5.000 - 20.000	5.000 - 20.000	1.000 - 13.000	1.000 - 13.000	3.000 - 12.000	3.000 - 12.000	1.000 - 14.290	1.000 - 14.290	1.000 - 14.000	1.000 - 14.290
Std. Dia. Range In.	0.1969 - 0.7874	0.1969 - 0.7874	0.0394 - 0.5118	0.0394 - 0.5118	0.1181 - 0.4724	0.1181 - 0.4724	0.0394 - 0.5626	0.0394 - 0.5626	0.0394 - 0.5512	0.0394 - 0.5626
Catalog Page	204	205	168	183	210	211	273	251	271	141
Tech Data Page	458	458	446	449	460	460	486	484	486	439

Taper Length Drills



SERIES	217	667	219	501	535	668	390	317	617	669	336	5536	5537
Style	N	N	W	GT50	GT100	GT100	GT100	N	Ti	Ti	GT100	GU 500 DZ	GU 500 DZ
Point Angle	118°	118°	130°	130°	130°	130°	130°	118°	130°	130°	130°	118°	118°
Length	Taper	Taper	Taper	Taper	Taper	Taper	Taper	Taper	Taper	Taper	Taper	Taper	Taper
Shank													
Coolant													
Substrate	HSS	HSS	HSS	HSS	HSS	HSS	HSS	Cobalt	Cobalt	Cobalt	Cobalt	Cobalt	Cobalt
Surface Finish													
Std. Dia. Range mm	0.400 - 25.000	0.500 - 18.250	0.400 - 20.000	1.000 - 14.000	1.000 - 14.000	1.000 - 14.000	3.000 - 13.000	0.500 - 16.000	1.000 - 15.870	1.000 - 10.000	1.000 - 12.000	1.000 - 14.290	1.000 - 14.290
Std. Dia. Range In.	0.0157 - 0.9843	0.0197 - 0.7185	0.0157 - 0.7874	0.0394 - 0.5512	0.0394 - 0.5512	0.0394 - 0.5512	0.1181 - 0.5118	0.0197 - 0.6299	0.0394 - 0.6248	0.0394 - 0.3937	0.0394 - 0.4724	0.0394 - 0.5626	0.0394 - 0.5626
Catalog Page	85	190	88	130	143	192	129	121	164	194	126	279	281
Tech Data Page	426	451	426	435	440	452	435	433	444	452	434	488	488





















HSS / Cobalt Drills

Extra Length Drills















SERIES	235	502	524	670	618	503	671	619	504
Style	N	GT100	GT50	GT100	GT100	GT100	GT100	GT100	GT100
Point Angle	118°	130°	130°	130°	130°	130°	130°	130°	130°
Length	XL #1	XL #1	XL #1	XL #1	XL #1	XL #2	XL #2	XL #2	XL #3
Shank									
Coolant									
Substrate	HSS	HSS	HSS	HSS	Cobalt	HSS	HSS	Cobalt	HSS
Surface Finish									
Std. Dia. Range mm	1.600 - 13.000	1.950 - 13.000	2.000 - 12.700	1.980 - 12.500	2.700 - 10.000	2.300 - 13.000	3.000 - 8.000	3.000 - 10.000	2.500 - 12.500
Std. Dia. Range In.	0.063 - 0.5118	0.0768 - 0.5118	0.0787 - 0.500	0.078 - 0.4921	0.1063 - 0.3937	0.0906 - 0.5118	0.1181 - 0.3150	0.1181 - 0.3937	0.1181 - 0.4921
Catalog Page	101	132	138	195	166	134	196	167	135
Tech Data Page	429	436	438	453	445	436	453	445	437





































NC Spot Drills

					
SERIES	556	557	567	568	559
Style	NC Spot	NC Spot	NC Spot	NC Spot	NC Spot
Point Angle	120°	90°	120°	90°	90°
Length	Spot	Spot	Spot	Spot	Spot
Shank					
Coolant					
Substrate	HSS	HSS	HSS	HSS	HSS
Surface Finish					
Std. Dia. Range mm	3.000 - 25.400	3.000 - 25.400	3.000 - 25.400	3.000 - 25.400	6.350 - 25.400
Std. Dia. Range In.	0.1181 - 1.000	0.1181 - 1.000	0.1181 - 1.000	0.1181 - 1.000	0.2500 - 1.000
Catalog Page	145	145	145	145	145
Tech Data Page	N/A	N/A	N/A	N/A	N/A

Micro Drills

			
SERIES	301	303	660
Style	N	N (LH)	N
Point Angle	118°	118°	118°
Length	Micro	Micro	Micro
Shank			
Coolant			
Substrate	Cobalt	Cobalt	Cobalt
Surface Finish			
Std. Dia. Range mm	0.050 - 1.920	0.130 - 1.850	0.128 - 1.800
Std. Dia. Range In.	0.002 - 0.0756	0.0051 - 0.0728	0.0050 - 0.0709
Catalog Page	111	113	187
Tech Data Page	431	431	450

Morse Taper Shank Drills

									
SERIES	245	654	345	257	666	551	266	526	527
Style	N	N	N	N	N	GT100	N	GT100	GT100
Point Angle	118°	118°	118°	118°	118°	130°	118°	130°	130°
Length	Jobber	Jobber	Jobber	Bushing	Bushing	Bushing	XL #1	XL #1	XL #2
Shank									
Coolant									
Substrate	HSS	HSS	Cobalt	HSS	HSS	HSS	HSS	HSS	HSS
Surface Finish									
Std. Dia. Range mm	2.380 - 79.370	3.000 - 30.500	3.000 - 25.400	4.000 - 29.370	1.000 - 11.500	6.000 - 31.500	8.500 - 34.000	8.000 - 30.160	8.000 - 29.500
Std. Dia. Range In.	0.0937 - 3.1248	0.1181 - 1.2008	0.1181 - 1.0000	0.1575 - 1.1563	0.0394 - 0.4528	0.2362 - 1.2402	0.3346 - 1.3386	0.315 - 1.1874	0.315 - 1.1614
Catalog Page	102	179	128	105	189	151	106	139	140
Tech Data Page	429	448	434	430	451	441	430	438	439

Center Drills / Countersinks

Center Drills / Countersinks



SERIES	281	282	283	284	285	287	288	289	292	294	581	582	583	584
Style	Form A	Form A (LH)	Form R	Form R (LH)	Form B	Form A	Form R	Form B	Form A	Form A (LH)	Form A	Form A (LH)	Form R	Form R (LH)
Point Angle	60°	60°	60°	60°	60°/120°	60°	60°	60°/120°	60°	60°	60°	60°	60°	60°
Standard	Guhring	DIN 333A	DIN 333R	DIN 333R	DIN 320B	<i>DIN 333A</i>	<i>DIN 333R</i>	<i>DIN 320B</i>	BS 328R	BS 328L	DIN 333A	DIN 333A	DIN 333R	DIN 333R
Shank	Round	Round	Round	Round	Round	Flatted	Flatted	Flatted	Round	Round	Round	Round	Round	Round
Coolant														
Substrate	HSS	HSS	HSS	HSS	HSS	HSS	HSS	HSS	HSS	HSS	HSS	HSS	HSS	HSS
Surface Finish	○	○	○	○	○	○	○	○	○	○	○	○	○	○
Std. Dia. Range mm	0.500 - 10.000	0.800 - 5.000	0.500 - 10.000	1.250 - 4.000	1.000 - 6.300	1.600 - 10.000	1.600 - 8.000	1.600 - 5.000			0.500 - 10.000	0.500 - 8.000	0.500 - 8.000	0.800 - 5.000
Std. Dia. Range In.									No. 1 - 7	No. 1 - 7				
Catalog Page	107	107	107	107	108	108	108	108	109	109	107	107	107	107
Tech Data Page	N/A	N/A	N/A	N/A	N/A	N/A	N/A	N/A	N/A	N/A	N/A	N/A	N/A	N/A

Center Drills / Countersinks



SERIES	585	586	587	588	589	590	591	594	595	613	614	381	736	280
Style	Form B	Form B (LH)	Form A	Form R	Form B	Form A	Form B	Form A	Form B	Form A	Form R	Form A	Form A	Form A
Point Angle	60°/120°	60°	60°	60°	60°/120°	60°	60°/120°	60°	60°/120°	60°	60°	60°	60°	60°
Standard	DIN 333B	DIN 333B	DIN 333A	<i>DIN 333R</i>	<i>DIN 333B</i>	<i>DIN 333A</i>	<i>DIN 333B</i>	ASA	ASA	DIN 333A	DIN 333R	DIN 333A	<i>DIN 333A</i>	Guhring
Shank	Round	Round	Flatted	Flatted	Flatted	Round	Round	Round	Round	Round	Round	Round	Round	Round
Coolant														
Substrate	HSS	HSS	HSS	HSS	HSS	HSS	HSS	HSS	HSS	HSS	HSS	Cobalt	Carbide	HSS
Surface Finish	○	○	○	○	○	○	○	○	○	Ⓢ	Ⓢ	○	○	○
Std. Dia. Range mm	1.000 - 10.000	1.000 - 10.000	1.600 - 10.000	1.600 - 8.000	1.600 - 8.000	1.000 - 10.000	1.000 - 10.000			0.500 - 8.000	0.800 - 8.000	1.000 - 4.000	0.500 - 6.300	1.000 - 3.150
Std. Dia. Range In.								No. 1 - 8	No. 11 s-18					
Catalog Page	108	108	110	110	110	107	107	109	109	107	107	107	107	107
Tech Data Page	N/A	N/A	N/A	N/A	N/A	N/A	N/A	N/A	N/A	N/A	N/A	N/A	N/A	N/A

With so many tools in Guhring's offering, how do you find the right one for your application?

Guhring has developed a number of ways to help you identify the best Guhring drill, end mill or tap for your application quickly and easily:

First, you can log onto the new www.guhring.com to find a number of helpful resources. Here you'll find a link to Guhring Navigator tool finder software. Navigator allows you to provide basic information about an application and instantly receive a Guhring tooling solution. Just provide the type of material to be machined and the style of tool needed and Navigator will provide the proper Guhring tool as well as the correct operating parameters.

NEW for 2013: Thread Mill Program Generator

Guhring understands that several manufacturers new to thread milling may need help programming their CNC machines properly. Guhring has provided these users with a thread mill CNC program generator to aid in programming their machine for thread mill usage. You can either use the online version or download an installer for a computer that has no internet access. Both options will allow someone to choose tool specifications available for Guhring thread mills and have the option to export the code to a text file.

All Guhring product literature is also available on our website as PDF files for you to view or download, so you are able to page through our most recent catalogs at any time. Each of our main line catalogs begins with a helpful illustrated index to guide you toward the best Guhring drill, end mill or tap for your application, as well as a complete technical section with running parameters.

Our Technical Support staff stands ready to assist you, whether you elect to make a phone call to (800) 776-6170, or to complete the brief online form found at guhring.com under the Technical tab. Expert answers to your tooling or application questions are just a call or a few clicks away!

High-Performance Cutting Tools for Composite and Aerospace Materials



Standard tooling:







Carbide Routers
PCD End Mills
90° Diamond Coated Drills



PCD Special Tooling Capabilities:

Please see PCD section for information, page 330.







































This guide will help you find a drill that's well suited to your application. To begin, identify the workpiece material from the materials groups listed below:

Color Code	Material Guide (Chemical Description or ANSI standard)	Page
	General Steels, Brass, Copper 1035, 1213, 12L13, 11L08, 1015, 1038, 1018	40
	Alloyed Steels, Nitrided Steels, Case Hardened Steels S1, 4140, 4150, 4137, 4135	44
	Stainless and Acid-Resistant Steels 316, 321, 316Ti, 410, 420	48
	Tool Steels, High-Tensile Steels, Hardened Materials D1, H13, H21, O2, M2, W110, 4130, 1045, 1060	52
	Aluminum and Aluminum Alloys Al99, AlMn1Mg0.5, AlCuMgPb, AlZnMgCu1	56
	Cast Iron No35B, No45B, No55B, 60-40-18, 80-55-06, 50005, 70003	60
	Titanium and Ti-Alloys, Aerospace Materials, Nickel-Based Alloys 5390A, Titanium, TiAl6V4, TiCu2, Nimonic, Inconel, Hastelloy, Waspaloy	64

Next, look for the color code associated with your workpiece material on the following pages. On the color-corresponding page will be a listing of the most popular drills for that material, arranged by drill length. Choose the drill series that most closely fits your application, and follow the column down to the listing of the page number that will display the full diameter range for that drill series.

Looking for a different substrate/coating combination, or other changes in options offered in this catalog? Contact our Specials department to learn about Guhring's extensive capabilities in producing special tooling to fit your needs.













































High-Performance Drill Recommendations

Series													
Length	4xD/7xD	3xD	3xD	3xD	5xD	5xD	5xD	5xD	7xD	8xD	12xD	3, 5, 7 x D	15xD - 40xD
Shank													
Style	Micro	RT 100 U	RT 100 U	RT100X	GS 200 U 3-flute	RT 100 U	RT100X	RT 100 U	RT100X	GT 100	RT 100 C	RT 800 WP/ HT 800 WP	RT 100 T
Point Angle	140°	140°	140°	140°	150°	140°	140°	140°	140°	130°	140°	140°	135°
Coolant Fed													
Substrate	Carbide	Carbide	Carbide	Carbide	Carbide	Carbide	Carbide	Carbide	Carbide	Carbide	Carbide	Carbide	Carbide
Surface Finish	A	S	S	N	S	S	N	S	N	S	F	N	A
Structural Steel	✓	✓	✓	✓	✓	✓	✓	✓	✓	✓	✓	✓	✓
Free-cutting steel	✓	✓	✓	✓	✓	✓	✓	✓	✓	✓	✓	✓	✓
Unalloyed steels	✓	✓	✓	✓	✓	✓	✓	✓	✓	✓	✓	✓	✓
Copper	✓	✓	✓	✓	✓	✓	✓	✓	✓	✓	✓	✓	
Brass	✓	✓	✓	✓	✓	✓	✓	✓	✓	✓	✓	✓	
Size range mm	0.50 - 3.00	3.00 - 16.00	3.00 - 20.00	3.00 - 20.00	3.00 - 20.00	5.00 - 16.00	3.00 - 20.00	3.00 - 20.00	3.00 - 20.00	3.17 - 12.70	3.00 - 20.00	11.00 - 25.50	3.00 - 14.00
Sizes page	298	212	208	226	160	214	228	206	250	231	277	238	305-306

Material group	Examples
Common structural steels	A283, A516, Gr50, 30, 35, 42, 45, 50, 55, 60, 65, 70, 75, 80, 85, 90, 100, 110, 135, 140, 145, 150, 160
Free-cutting steels	1151, 1215, L10, 10L10, 10L15, 10L17, 10L20, 10L23, 10L25, 10L30, 10L35, 10L40, 10L42, 10L45, 10L49, 10L50, 10L55, 11L15, 11L16, 11L17, 11L37, 11L38, 11L39, 11L41, 11L44, 11L46, 12L11, 12L12, 12L13, 12L14, 12L15, 41L25, 41L30, 41L35, 41L40, 41L42, 41L47, 41L50 51L15, 51L17, 51L20, 86L20, 86L40
Unalloyed heat-treatable steels	1005, 1006, 1008, 1009, 1010, 1011, 1012, 1013, 1015, 1016, 1017, 1018, 1019, 1020, 1021, 1022, 1023, 1025, 1026, 1029, 1030, 1033, 1035, 1037, 1038, 1039, 1040, 1042, 1043, 1044, 1045, 1046, 1049, 1050, 1053, 1055, 1059, 1060, 1064, 1065, 1069, 1070, 1071, 1074, 1075, 1078, 1080, 1084, 1085, 1086, 1090, 1095
Copper, low-alloyed	C10100, C27000, C71500, C52400, C77000, C17200, C71500, C95500, C86500
Brass, short-chipping	CUZn10, CUZn20



Stub Length (3xD) Drills













































											
Series	301	303	223	226	225	224	552	553	653	5520	730
Length	Micro	Micro (LH)	3xD	3xD (LH)	3xD	3xD	3xD	3xD (LH)	3xD	3xD	3xD
Shank											
Style	N	N	N	N	W	H	GT80	GT80	N	GU500DZ	N
Point Angle	118°	118°	118°	118°	130°	118°	130°	130°	118°	118°	118°
Coolant Fed											
Substrate	Cobalt	Cobalt	HSS	HSS	HSS	HSS	HSS	HSS	HSS	Cobalt	Carbide
Surface Finish											
Structural Steel	✓	✓	✓	✓			✓	✓	✓	✓	✓
Free-cutting steel	✓	✓	✓	✓	✓		✓	✓	✓	✓	✓
Unalloyed steels	✓	✓	✓	✓	✓		✓	✓	✓	✓	✓
Copper	✓	✓	✓	✓	✓	✓	✓	✓	✓	✓	✓
Brass	✓	✓	✓	✓		✓	✓	✓	✓	✓	✓
Size range mm	0.05 - 1.92	0.13 - 1.85	0.40 - 31.75	0.50 - 44.45	1.00 - 20.00	0.90 - 22.00	1.00 - 20.00	1.00 - 20.00	0.50 - 28.50	1.00 - 14.29	0.50 - 16.00
Sizes page	111	113	90	98	96	94	152	155	176	267	197

Free toolfinder software

Find the best-suited Guhring cutting tools for your application -- quickly and easily -- with Guhring Navigator. Go to www.guhring.com and click on the icon to test drive this software.















































Jobber Length (5xD) Drills

											
Series	205	208	664	206	651	549	652	5519	2602	732	2464
Length	5xD	5xD (LH)	5xD (LH)	5xD	5xD	5xD	5xD	5xD	5xD	5xD	5xD
Shank											
Style	N	N	N	H	N	GT100	GT100	GU500 DZ	GT100	N	N
Point Angle	118°	118°	118°	118°	118°	130°	130°	118°	118°	118°	118°
Coolant Fed											
Substrate	HSS	HSS	HSS	HSS	HSS	HSS	HSS	Cobalt	Carbide	Carbide	Carbide
Surface Finish											
Structural Steel	✓	✓	✓		✓	✓	✓	✓	✓	✓	✓
Free-cutting steel	✓	✓	✓		✓	✓	✓	✓	✓	✓	✓
Unalloyed steels	✓	✓	✓		✓	✓	✓	✓	✓	✓	✓
Copper	✓	✓	✓	✓	✓	✓	✓	✓	✓	✓	✓
Brass	✓	✓	✓	✓	✓	✓	✓	✓	✓	✓	✓
Size range mm	0.20 - 20.00	0.24 - 16.00	0.40 - 10.20	0.20 - 20.00	0.20 - 19.00	0.60 - 16.00	1.00 - 16.00	1.00 - 14.29	3.17 - 12.70	1.00 - 12.70	1.00 - 12.70
Sizes page	71	82	188	76	170	146	174	265	231	199	224

Material group	Examples
Common structural steels	A283, A516, Gr50, 30, 35, 42, 45, 50, 55, 60, 65, 70, 75, 80, 85, 90, 100, 110, 135, 140, 145, 150, 160
Free-cutting steels	1151, 1215, L10, 10L10, 10L15, 10L17, 10L20, 10L23, 10L25, 10L30, 10L35, 10L40, 10L42, 10L45, 10L49, 10L50, 10L55, 11L15, 11L16, 11L17, 11L37, 11L38, 11L39, 11L41, 11L44, 11L46, 12L11, 12L12, 12L13, 12L14, 12L15, 41L25, 41L30, 41L35, 41L40, 41L42, 41L47, 41L50, 51L15, 51L17, 51L20, 86L20, 86L40
Unalloyed heat-treatable steels	1005, 1006, 1008, 1009, 1010, 1011, 1012, 1013, 1015, 1016, 1017, 1018, 1019, 1020, 1021, 1022, 1023, 1025, 1026, 1029, 1030, 1033, 1035, 1037, 1038, 1039, 1040, 1042, 1043, 1044, 1045, 1046, 1049, 1050, 1053, 1055, 1059, 1060, 1064, 1065, 1069, 1070, 1071, 1074, 1075, 1078, 1080, 1084, 1085, 1086, 1090, 1095
Copper, low-alloyed	C10100, C27000, C71500, C52400, C77000, C17200, C71500, C95500, C86500
Brass, short-chipping	CUZn10, CUZn20



Extra Length ($\geq 10xD$) Drills





































											
Series	535	5537	390	235	502	266	526	503	671	527	504
Length	10xD	10xD	10xD	Extra #1	Extra #1	Extra #1	Extra #1	Extra #2	Extra #2	Extra #2	Extra #3
Shank											
Style	GT100	GU500 DZ	GT100	N	GT100	N	GT100	GT100	GT100	GT100	GT100
Point Angle	130°	118°	130°	118°	130°	118°	130°	130°	130°	130°	130°
Coolant Fed											
Substrate	HSS	Cobalt	HSS	HSS	HSS	HSS	HSS	HSS	HSS	HSS	HSS
Surface Finish											
Structural Steel	✓	✓	✓	✓	✓	✓	✓	✓	✓	✓	✓
Free-cutting steel	✓	✓	✓	✓	✓	✓	✓	✓	✓	✓	✓
Unalloyed steels	✓	✓	✓	✓	✓	✓	✓	✓	✓	✓	✓
Copper	✓	✓	✓	✓	✓	✓	✓	✓	✓	✓	✓
Brass	✓	✓	✓	✓	✓	✓	✓	✓	✓	✓	✓
Size range mm	1.00 - 14.00	1.00 - 14.29	3.00 - 13.00	1.60 - 13.00	1.95 - 13.00	8.50 - 34.00	8.00 - 30.16	2.30 - 13.00	3.00 - 8.00	8.00 - 29.50	2.50 - 13.00
Sizes page	155	281	129	101	132	106	139	134	196	140	135

Free toolfinder software

Find the best-suited Guhring cutting tools for your application -- quickly and easily -- with Guhring Navigator. Go to www.guhring.com and click on the icon to test drive this software.



High-Performance Drill Recommendations













































												
Series	5514	5510	2477	5515	5511	2479	609	5512	4044	5525	4112 (Insert)	6509 - 6514
Length	3xD	3xD	3xD	5xD	5xD	5xD	5xD	7xD	7xD	12xD	3, 5, 7 x D	15xD - 40xD
Shank												
Style	RT100U	RT100U	RT100X	RT100U	RT100U	RT100X	GS200U 3-flute	RT100U	RT100X	RT100C	HT800 / RT800WP	RT 100 T
Point Angle	140°	140°	140°	140°	140°	140°	150°	140°	140°	140°	140°	135°
Coolant Fed												
Substrate	Carbide	Carbide	Carbide	Carbide	Carbide	Carbide	Carbide	Carbide	Carbide	Carbide	Carbide	Carbide
Surface Finish	F	F	N	F	F	N	S	F	N	F	N	A
Unalloyed case hardened steels	✓	✓	✓	✓	✓	✓	✓	✓	✓	✓	✓	✓
Alloyed case hardened steels	✓	✓	✓	✓	✓	✓	✓	✓	✓	✓	✓	
Alloyed heat-treatable steels	✓	✓	✓	✓	✓	✓	✓	✓	✓	✓	✓	✓
Nitriding steels	✓	✓	✓	✓	✓	✓	✓	✓	✓	✓	✓	
Size Range (mm)	3.00 - 20.00	3.00 - 20.00	3.00 - 20.00	3.00 - 20.00	3.00 - 20.00	3.00 - 20.00	3.00 - 20.00	3.00 - 20.00	3.00 - 20.00	3.00 - 20.00	11.00 - 25.50	3.00 - 14.00
Sizes page	260	253	226	262	255	228	160	257	250	277	238	305-306

Material group	Examples
Unalloyed case hardened steels	1005, 1006, 1008, 1009, 1010, 1011, 1012, 1013, 1015, 1016, 1017, 1018, 1019, 1020, 1021, 1022, 1023, 1025, 1026, 1029, 1030, 1033, 1035, 1037, 1038, 1039, 1040, 1042, 1043, 1044, 1045, 1046, 1049, 1050, 1053, 1055, 1059, 1060, 1064, 1065, 1069, 1070, 1071, 1074, 1075, 1078, 1080, 1084, 1085, 1086, 1090, 1095
Alloyed case hardened steels	2317, 2512, 2515, 2517, 3115, 3120, 3215, 3220, 3312, 3316, 3325, 4012, 4023, 4024, 4027, 4028, 4118, 4119, 4125, 4317, 4320, 4419, 4422, 4427, 4608, 4615, 4617, 4620, 4621, 4626, 4718, 4720, 4815, 4817, 4820, 5015, 5115, 5117, 5120, 6115, 6118, 6120, 6125, 8115, 8615, 8617, 8620, 8622, 8625, 8627, 8720, 8822, 9310, 9315, 9317
Alloyed heat-treatable steels	1330, 1335, 1340, 1345, 2340, 3140, 3145, 3150, 3230, 3240, 3335, 3340, 3435, 3450, 4032, 4037, 4063, 4130, 4135, 4137, 4140, 4142, 4145, 4147, 4150, 4161, 4337, 4340, 4640, 5045, 5046, 5060, 5130, 5132, 5135, 5140, 5145, 5157, 5150, 5155, 5160, 6130, 6135, 6140, 6145, 6150, 7140, 6145, 6150, 7140, 8630, 8632, 8635, 8637, 8640, 8642, 8645, 8650, 8650, 8660, 8735, 8740, 8742, 9250, 9254, 9255, 9260, 9262, 9840, 9850
Nitriding steels	1132, 1137, 1138, 1139, 1140, 1141, 1144, 1145, 1146, 1151





Stub Length (3xD) Drills

											
Series	660	303	553	610	329	659	5520	5521	515	730	2463
Length	Micro	Micro LH	3xD LH	3xD	3xD	3xD	3xD	3xD	3xD	3xD	3xD
Shank											
Style	N	N	GT80	Ti	GV120	GV120	GU500DZ	GT500DZ	GT500DZ	N	N
Point Angle	118°	118°	130°	130°	130°	130°	118°	130°	130°	118°	118°
Coolant Fed											
Substrate	Cobalt	Cobalt	HSS	Cobalt	Cobalt	Cobalt	Cobalt	PM-Cobalt	PM-Cobalt	Carbide	Carbide
Surface Finish											
Unalloyed case hardened steels	✓					✓		✓	✓		✓
Alloyed case hardened steels	✓			✓		✓		✓	✓		✓
Alloyed heat-treatable steels	✓	✓	✓	✓	✓	✓	✓	✓	✓	✓	✓
Nitriding steels	✓	✓	✓	✓	✓	✓	✓	✓	✓	✓	✓
Size Range (mm)	0.128 - 1.800	0.130 - 1.850	1.000 - 20.00	1.000 - 14.29	0.400 - 25.40	0.500 - 15.50	1.000 - 14.29	1.000 - 14.00	1.000 - 14.29	0.500 - 16.00	1.000 - 16.00
Sizes page	187	113	155	162	123	185	267	269	136	197	222

Free toolfinder software

Find the best-suited Guhring cutting tools for your application -- quickly and easily -- with Guhring Navigator. Go to www.guhring.com and click on the icon to test drive this software.



Jobber Length (5xD) Drills

Series	305	308	5519	605	657	622	658	2458	1132	530	2464
Length	5xD	5xD (LH)	5xD	5xD	5xD	5xD	5xD	5xD	5xD	5xD	5xD
Shank											
Style	N	N	GU500DZ	Ti	Ti	GT100	GT100	Ti	GT80	GT500DZ	N
Point Angle	118°	118°	118°	130°	130°	130°	130°	130°	130°	130°	118°
Coolant Fed											
Substrate	Cobalt	Cobalt	Cobalt	Cobalt	Cobalt	Cobalt	Cobalt	Cobalt	Cobalt	PM-Cobalt	Carbide
Surface Finish											
Unalloyed case hardened steels			✓		✓		✓	✓	✓	✓	✓
Alloyed case hardened steels			✓		✓		✓	✓	✓	✓	✓
Alloyed heat-treatable steels	✓	✓	✓	✓	✓	✓	✓	✓	✓	✓	✓
Nitriding steels	✓	✓	✓	✓	✓	✓	✓	✓	✓	✓	✓
Size Range (mm)	0.20 - 20.00	0.48 - 12.70	1.00 - 14.29	0.30 - 19.05	0.50 - 13.00	1.00 - 13.00	1.00 - 13.00	4.00 - 15.00	5.00 - 20.00	1.00 - 14.29	1.00 - 12.70
Sizes page	115	119	265	157	181	168	183	220	205	141	224

Material group	Examples
Unalloyed case hardened steels	1005, 1006, 1008, 1009, 1010, 1011, 1012, 1013, 1015, 1016, 1017, 1018, 1019, 1020, 1021, 1022, 1023, 1025, 1026, 1029, 1030, 1033, 1035, 1037, 1038, 1039, 1040, 1042, 1043, 1044, 1045, 1046, 1049, 1050, 1053, 1055, 1059, 1060, 1064, 1065, 1069, 1070, 1071, 1074, 1075, 1078, 1080, 1084, 1085, 1086, 1090, 1095
Alloyed case hardened steels	2317, 2512, 2515, 2517, 3115, 3120, 3215, 3220, 3312, 3316, 3325, 4012, 4023, 4024, 4027, 4028, 4118, 4119, 4125, 4317, 4320, 4419, 4422, 4427, 4608, 4615, 4617, 4620, 4621, 4626, 4718, 4720, 4815, 4817, 4820, 5015, 5115, 5117, 5120, 6115, 6118, 6120, 6125, 8115, 8615, 8617, 8620, 8622, 8625, 8627, 8720, 8822, 9310, 9315, 9317
Alloyed heat-treatable steels	1330, 1335, 1340, 1345, 2340, 3140, 3145, 3150, 3230, 3240, 3335, 3340, 3435, 3450, 4032, 4037, 4063, 4130, 4135, 4137, 4140, 4142, 4145, 4147, 4150, 4161, 4337, 4340, 4640, 5045, 5046, 5060, 5130, 5132, 5135, 5140, 5145, 5155, 5160, 6130, 6135, 6140, 6145, 6150, 7140, 6145, 6150, 7140, 8630, 8632, 8635, 8637, 8640, 8642, 8645, 8650, 8650, 8660, 8735, 8740, 8742, 9250, 9254, 9255, 9260, 9262, 9840, 9850
Nitriding steels	1132, 1137, 1138, 1139, 1140, 1141, 1144, 1145, 1146, 1151





Extra Length ($\leq 10xD$) Drills

Series	5020 - 5026	345	5537	336	617	669	618	619	504
Length	45mm FL - 160 mm FL	10xD	10xD	10xD	10xD	10xD	Extra #1	Extra #2	Extra #3
Shank									
Style	EB100	N	GU500 DZ	GT100	Ti	Ti	GT100	GT100	GT100
Point Angle	Special	118°	118°	130°	130°	130°	130°	130°	130°
Coolant Fed									
Substrate	Carbide	Cobalt	Cobalt	Cobalt	Cobalt	Cobalt	Cobalt	Cobalt	HSS
Surface Finish									
Unalloyed case hardened steels	✓	✓			✓	✓	✓	✓	
Alloyed case hardened steels	✓	✓			✓	✓	✓	✓	
Alloyed heat-treatable steels	✓	✓	✓	✓	✓	✓	✓	✓	✓
Nitriding steels	✓	✓	✓	✓	✓	✓	✓	✓	✓
Size Range (mm)	1.20 - 5.00	3.00 - 25.40	1.00 - 14.29	1.00 - 12.00	1.00 - 15.87	1.00 - 10.00	2.70 - 10.00	3.00 - 10.00	2.50 - 13.00
Sizes page	252	128	281	126	164	194	166	167	135

Free toolfinder software

Find the best-suited Guhring cutting tools for your application -- quickly and easily -- with Guhring Navigator. Go to www.guhring.com and click on the icon to test drive this software.









































High-Performance Drill Recommendations

Series	5514	5741	8510	5515	5744	8511	609	5512	5746	5525	4115 (Insert)	6509-6514
Length	3xD	3xD	3xD	5xD	5xD	5xD	5xD	7xD	7xD	12xD	3, 5, 7 x D	15xD - 40xD
Shank												
Style	RT100U	RT100US	RT100VA	RT100U	RT100US	RT100VA	GS200U 3-flute	RT100U	RT100US	RT100C	HT800 / RT800WP	RT 100 T
Point Angle	140°	140°	140°	140°	140°	140°	150°	140°	140°	140°	140°	135°
Coolant Fed												
Substrate	Carbide	Carbide	Carbide	Carbide	Carbide	Carbide	Carbide	Carbide	Carbide	Carbide	Carbide	Carbide
Surface Finish	F	a	a	F	a	a	S	F	a	F	a	A
Austenitic 300	✓	✓	✓	✓	✓	✓	✓	✓	✓	✓	✓	
Martensitic 400	✓	✓	✓	✓	✓	✓	✓	✓	✓	✓	✓	✓
Ph Stainless	✓	✓	✓	✓	✓	✓	✓	✓	✓	✓	✓	
Size range mm	3.00 - 20.00	3.00 - 12.70	3.00 - 20.00	3.00 - 20.00	3.00 - 12.70	3.00 - 20.00	3.00 - 20.00	3.00 - 20.00	3.00 - 12.70	3.00 - 20.00	11.00 - 25.50	3.00 - 14.00
Sizes page	260	290	307	262	292	309	160	257	294	277	238	305-306

Material group	Examples
Stainless steels, sulphured	203 Ez, 303 Se, 303 Ma, 303 Pb, 303 PlusX, 430F Se, 416 Se, 416 PlusX, 420F, 420F Se, 440F, 440F Se
austenitic	201, 202, 301, 302B, 303, 304, 304L, 305, 308, 309, 309S, 310, 310S, 314, 316, 316L, 317, 321, 330, 347, 348, 384, 385, Nitronic 32, Nitronic 33, Nitronic 40, Nitronic 50, Nitronic 60, 17-7PH
martensitic	403, 405, 410, 414, 416, 420, 422, 430, 431, 440A, 440B, 440C, 446, 501, 502, 630, Greek Ascology



Stub Length (3xD) Drills

									
Series	660	6401	329	610	659	5520	5521	515	2463
Length	4xD	7xD	3xD	3xD	3xD	3xD	3xD	3xD	3xD
Shank									
Style	Micro	Micro	GV120	Ti	GV120	GU500DZ	GT500DZ	GT500DZ	N
Point Angle	118°	140°	130°	130°	130°	118°	130°	130°	118°
Coolant Fed									
Substrate	Cobalt	Carbide	Cobalt	Cobalt	Cobalt	Cobalt	PM-Cobalt	PM-Cobalt	Carbide
Surface Finish									
Austenitic 300	✓	✓	✓	✓	✓	✓	✓	✓	✓
Martensitic 400	✓	✓	✓	✓	✓	✓	✓	✓	✓
Ph Stainless	✓	✓	✓	✓	✓	✓	✓	✓	✓
Size range mm	0.128 - 1.800	0.500 - 3.000	0.400 - 25.400	1.000 - 14.290	0.500 - 15.500	1.000 - 14.290	1.000 - 14.000	1.000 - 14.290	1.000 - 16.000
Sizes page	187	298	123	162	185	267	269	136	222



























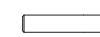









Free toolfinder software

Find the best-suited Guhring cutting tools for your application -- quickly and easily -- with Guhring Navigator. Go to www.guhring.com and click on the icon to test drive this software.





Jobber Length (5xD) Drills





































									
Series	305	5519	605	657	622	658	1132	530	2464
Length	5xD	5xD	5xD	5xD	5xD	5xD	5xD	5xD	5xD
Shank									
Style	N	GU500DZ	Ti	Ti	GT100	GT100	GT80	GT500DZ	N
Point Angle	118°	118°	130°	130°	130°	130°	130°	130°	118°
Coolant Fed									
Substrate	Cobalt	Cobalt	Cobalt	Cobalt	Cobalt	Cobalt	Cobalt	PM-Cobalt	Carbide
Surface Finish									
Austenitic 300	√	√	√	√	√	√	√	√	√
Martensitic 400	√	√	√	√	√	√	√	√	√
Ph Stainless	√	√	√	√	√	√	√	√	√
Size range mm	0.20 - 20.00	1.00 - 14.29	0.30 - 19.05	0.50 - 13.00	1.00 - 13.00	1.00 - 13.00	5.00 - 20.00	1.00 - 14.29	1.00 - 12.70
Sizes page	115	265	157	181	168	183	205	141	224

Material group	Examples
Stainless steels, sulphured	203 Ez, 303 Se, 303 Ma, 303 Pb, 303 PlusX, 430F Se, 416 Se, 416 PlusX, 420F, 420F Se, 440F, 440F Se
austenitic	201, 202, 301, 302B, 303, 304, 304L, 305, 308, 309, 309S, 310, 310S, 314, 316, 316L, 317, 321, 330, 347, 348, 384, 385, Nitronic 32, Nitronic 33, Nitronic 40, Nitronic 50, Nitronic 60, 17-7PH
martensitic	403, 405, 410, 414, 416, 420, 422, 430, 431, 440A, 440B, 440C, 446, 501, 502, 630, Greek Ascology





Extra Length ($\leq 10xD$) Drills





































									
Series	6408 / 6412	5020 - 5026	345	5537	336	617	669	618	619
Length	8xD / 15xD	45mm FL - 160 mm FL	10xD	10xD	10xD	10xD	10xD	Extra #1	Extra #2
Shank									
Style	Micro	EB100	N	GU500DZ	GT100	Ti	Ti	GT100	GT100
Point Angle	140°	Special	118°	118°	130°	130°	130°	130°	130°
Coolant Fed									
Substrate	Carbide	Carbide	Cobalt	Cobalt	Cobalt	Cobalt	Cobalt	Cobalt	Cobalt
Surface Finish									
Austenitic 300	✓	✓	✓	✓	✓	✓	✓	✓	✓
Martensitic 400	✓	✓	✓	✓	✓	✓	✓	✓	✓
Ph Stainless	✓	✓	✓	✓	✓	✓	✓	✓	✓
Size range mm	1.40 - 3.00	1.20 - 8.00	3.00 - 25.40	1.00 - 14.29	1.00 - 12.00	1.00 - 15.87	1.00 - 10.00	2.70 - 10.00	3.00 - 10.00
Sizes page	300	252	128	281	126	164	194	166	167

Free toolfinder software

Find the best-suited Guhring cutting tools for your application -- quickly and easily -- with Guhring Navigator. Go to www.guhring.com and click on the icon to test drive this software.























High-Performance Drill Recommendations

												
Series	5514	5510	8520	5515	5511	8521	609	5512	8522	5525	4112 (Insert)	6509 - 6514
Length	3xD	3xD	3xD	5xD	5xD	5xD	5xD	7xD	7xD	12xD	3, 5, 7 x D	15xD - 40xD
Shank												
Style	RT100U	RT100U	RT100HF	RT100U	RT100U	RT100HF	GS200U 3-flute	RT100U	RT100HF	RT100C	HT800 / RT800WP	RT100T
Point Angle	140°	140°	140°	140°	140°	140°	150°	140°	140°	140°	140°	135°
Coolant Fed												
Substrate	Carbide	Carbide	Carbide	Carbide	Carbide	Carbide	Carbide	Carbide	Carbide	Carbide	Carbide	Carbide
Surface Finish	F	F	Y	F	F	Y	S	F	Y	F	N	A
High speed steels	✓	✓	✓	✓	✓	✓	✓	✓	✓	✓	✓	
Spring steels	✓	✓	✓	✓	✓	✓	✓	✓	✓	✓	✓	
Hardened steels	✓	✓	✓	✓	✓	✓	✓	✓	✓	✓	✓	
Tool steels	✓	✓	✓	✓	✓	✓	✓	✓	✓	✓	✓	✓
Alloyed heat-treatable	✓	✓	✓	✓	✓	✓	✓	✓	✓	✓	✓	✓
Size range (mm)	3.00 - 20.00	3.00 - 20.00	3.00 - 20.00	3.00 - 20.00	3.00 - 20.00	3.00 - 20.00	3.00 - 20.00	3.00 - 20.00	3.00 - 16.00	3.00 - 20.00	11.00 - 25.50	3.00 - 14.00
Sizes page	260	253	311	262	255	313	160	257	315	277	238	305

Material group	Examples
High speed steels	M1, M2, M3-1, M3-2, M4, M6, M7, M10, M30, M33, M34, M36, M41, M42, M43, M44, M46, M47, T1, T2, T4, T5, T6, T8, T15
Spring steels	5150, 5155, 6145, 6150, 9255
Hardened steels >48-60 Rc	Heat Treated Steels
Tool steels	A2, A3, A4, A5, A6, A8, A9, A10, O1, O2, O6, O7, A7, D2, D3, D4, D5, D7, H10, H11, H12, H13, H14, H19, H20, H21, H22, H23, H24, H25, H26, H41, H42, H43, L1, L3, W1, W2, W5
Alloyed Heat Treatable	1330, 1335, 1340, 1345, 3140, 3145, 3150, 3230, 3240, 3335, 3340, 3435, 3450, 4032, 4037, 4063, 4130, 4135, 4137, 4140, 4142, 4145, 4147, 4150, 4161, 4337, 4340, 4640, 5045, 5046, 5060, 5130, 5132, 5135, 5140, 5145, 5157, 5150, 5155, 5160, 6130, 6135, 6140, 6145, 6150, 7140, 6145, 6150, 7140, 8630, 8632, 8635, 8637, 8640, 8642, 8645, 8650, 8650, 8660, 8735, 8740, 8742, 9250, 9254, 9255, 9260, 9262, 9840, 9850, 2340



Stub Length (3xD) Drills

							
Series	6400	3899	660	659	5521	515	2463
Length	4xD	4xD	4xD	3xD	3xD	3xD	3xD
Shank							
Style	Micro	Micro	Micro	GV120	GT500DZ	GT500DZ	N
Point Angle	140°	140°	118°	130°	130°	130°	118°
Coolant Fed							
Substrate	Carbide	Carbide	Cobalt	Cobalt	PM-Cobalt	PM-Cobalt	Carbide
Surface Finish	A	A	S	S	S	F	F
High speed steels	✓	✓	✓	✓	✓	✓	✓
Spring steels	✓	✓	✓	✓	✓	✓	✓
Hardened steels						✓	✓
Tool steels	✓	✓	✓	✓	✓	✓	✓
Alloyed heat-treatable	✓	✓	✓	✓	✓	✓	✓
Size range (mm)	0.50 - 3.00	1.00 - 3.00	0.128 - 1.80	0.50 - 15.50	1.00 - 14.00	1.00 - 14.29	1.00 - 16.00
Sizes page	298	232	187	185	269	136	222

































Free toolfinder software

Find the best-suited Guhring cutting tools for your application -- quickly and easily -- with Guhring Navigator. Go to www.guhring.com and click on the icon to test drive this software.





Jobber Length (5xD) Drills

































								
Series	6401	5519	657	658	2458	1132	530	2464
Length	7xD	5xD	5xD	5xD	5xD	5xD	5xD	5xD
Shank								
Style	Micro	GU500DZ	Ti	GT100	Ti	GT80	GT500DZ	N
Point Angle	140°	118°	130°	130°	130°	130°	130°	118°
Coolant Fed								
Substrate	Carbide	Cobalt	Cobalt	Cobalt	Cobalt	Cobalt	PM-Cobalt	Carbide
Surface Finish								
High speed steels	✓	✓	✓	✓	✓	✓	✓	✓
Spring steels	✓	✓	✓	✓	✓	✓	✓	✓
Hardened steels			✓		✓	✓	✓	✓
Tool steels	✓	✓	✓	✓	✓	✓	✓	✓
Alloyed heat-treatable	✓	✓	✓	✓	✓	✓	✓	✓
Size range (mm)	0.50 - 3.00	1.00 - 14.29	0.50 - 13.00	1.00 - 13.00	0.40 - 15.00	5.00 - 20.00	1.00 - 14.29	1.00 - 12.70
Sizes page	298	265	181	183	220	205	141	224

Material group	Examples
High speed steels	M1, M2, M3-1, M3-2, M4, M6, M7, M10, M30, M33, M34, M36, M41, M42, M43, M44, M46, M47, T1, T2, T4, T5, T6, T8, T15
Spring steels	5150, 5155, 6145, 6150, 9255
Hardened steels >48-60 Rc	Heat Treated Steels
Tool steels	A2, A3, A4, A5, A6, A8, A9, A10, O1, O2, O6, O7, A7, D2, D3, D4, D5, D7, H10, H11, H12, H13, H14, H19, H20, H21, H22, H23, H24, H25, H26, H41, H42, H43, L1, L3, W1, W2, W5
Alloyed Heat Treatable	1330, 1335, 1340, 1345, 3140, 3145, 3150, 3230, 3240, 3335, 3340, 3435, 3450, 4032, 4037, 4063, 4130, 4135, 4137, 4140, 4142, 4145, 4147, 4150, 4161, 4337, 4340, 4640, 5045, 5046, 5060, 5130, 5132, 5135, 5140, 5145, 5157, 5150, 5155, 5160, 6130, 6135, 6140, 6145, 6150, 7140, 6145, 6150, 7140, 8630, 8632, 8635, 8637, 8640, 8642, 8645, 8650, 8650, 8660, 8735, 8740, 8742, 9250, 9254, 9255, 9260, 9262, 9840, 9850, 2340





Extra Length ($\leq 10 \times D$) Drills























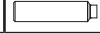























								
Series	6408 / 6412	5020 - 5026	345	5537	336	669	618	619
Length	8xD / 15xD	45mm FL - 160 mm FL	10xD	10xD	10xD	10xD	Extra #1	Extra #2
Shank								
Style	Micro	EB100	N	GU500DZ	GT100	Ti	GT100	GT100
Point Angle	140°	Special	118°	118°	130°	130°	130°	130°
Coolant Fed								
Substrate	Carbide	Carbide	Cobalt	Cobalt	Cobalt	Cobalt	Cobalt	Cobalt
Surface Finish								
High speed steels	✓	✓	✓	✓	✓	✓	✓	✓
Spring steels	✓	✓	✓	✓	✓	✓	✓	✓
Hardened steels						✓		
Tool steels	✓	✓	✓	✓	✓	✓	✓	✓
Alloyed heat-treatable	✓	✓	✓	✓	✓	✓	✓	✓
Size range (mm)	1.40 - 3.00	1.20 - 8.00	3.00 - 25.40	1.00 - 14.29	1.00 - 12.00	1.00 - 10.00	2.70 - 10.00	3.00 - 10.00
Sizes page	300	252	128	281	126	194	166	167

Free toolfinder software

Find the best-suited Guhring cutting tools for your application -- quickly and easily -- with Guhring Navigator. Go to www.guhring.com and click on the icon to test drive this software.































High-Performance Drill Recommendations

												
Series	1242	1702	768	5518	1243	1183	769	5512	2601	5513	5525	4114 (Insert)
Length	3xD	3xD	4xD	5xD	5xD	5xD	7xD	7xD	8xD	10xD	12xD	3, 5, 7 x D
Shank												
Style	RT100U	RT100F	RT150GG	GS200G 3-flute	RT100U	RT100U	RT150GG	RT100U	GT 100	RT150GG	RT100C	HT800 / RT800WP
Point Angle	140°	140°	120°	130°	140°	140°	120°	140°	130°	120°	140°	140°
Coolant Fed												
Substrate	Carbide	Carbide	Carbide	Carbide	Carbide	Carbide	Carbide	Carbide	Carbide	Carbide	Carbide	Carbide
Surface Finish												
Wrought aluminum	✓	✓		✓	✓	✓		✓	✓		✓	✓
Cast aluminum <10% Si	✓	✓		✓	✓	✓		✓	✓		✓	✓
Cast aluminum >10% Si			✓	✓			✓		✓	✓		✓
Size Range (mm)	3.00 - 16.00	3.00 - 15.00	3.00 - 20.00	3.00 - 20.00	5.00 - 16.00	3.00 - 20.00	3.00 - 20.00	3.00 - 20.00	3.17 - 12.70	3.00 - 16.00	3.00 - 20.00	11.00 - 25.50
Sizes page	212	219	201	264	214	206	202	257	230	259	277	239

Material group	Examples
Aluminium and Al-alloys	EC 1060, 1100, 1145, 1175, 1235, 2011, 2014, 2017, 2018, 2021, 2024, 2025, 2117, 2218, 2219, 2618, 3003, 3004, 3005, 4032, 4032-T6, 5005, 5050, 5052, 5056, 5083, 5086, 5154, 5252, 5254, 5454, 5456, 5457, 5652, 5657, 6053, 6061, 6061-T6, 6063, 6066, 6070, 6101, 6151, 6253, 6262, 6463, 6951, 7001, 7004, 7005, 7039, 7049, 7050, 7075, 7075-T6, 7079, 7175, 7178
Al wrought alloys	1100-0, 3003-H18, 5056-0, 2024-T4, 4043-H18
Al cast alloys	295-T6, 319-F, 356-T6, 380-F, 384-F, 390-F, 443-F, 413-F, 518-F, 713-TS, 850-TS

Stub Length (3xD) Drills































							
Series	6401	301	225	552	553	5524	730
Length	7xD	7xD	3xD	3xD	3xD (LH)	3xD	3xD
Shank							
Style	Micro	Micro	W	GT80	GT80	GU500DZ	N
Point Angle	140°	118°	130°	130°	130°	118°	118°
Coolant Fed							
Substrate	Carbide	Cobalt	HSS	HSS	HSS	Cobalt	Carbide
Surface Finish							
Wrought aluminum	✓	✓	✓	✓	✓	✓	✓
Cast aluminum <10% Si	✓	✓	✓	✓	✓	✓	✓
Cast aluminum >10% Si	✓	✓	✓	✓	✓	✓	✓
Size Range (mm)	0.50 - 3.00	0.05 - 1.92	1.00 - 20.00	1.00 - 20.00	1.00 - 20.00	1.00 - 14.29	0.50 - 16.00
Sizes page	298	111	96	152	155	275	197

Free toolfinder software

Find the best-suited Guhring cutting tools for your application -- quickly and easily -- with Guhring Navigator. Go to www.guhring.com and click on the icon to test drive this software.















































Jobber Length (5xD) Drills

										
Series	207	549	550	652	5523	658	5519	1131	732	2601
Length	5xD	5xD	5xD (LH)	5xD	5xD	5xD	5xD	5xD	5xD	8xD
Shank										
Style	W	GT100	GT100	GT100	GU500DZ	GT100	GU500DZ	GT80	N	GT100
Point Angle	130°	130°	130°	130°	118°	130°	118°	130°	118°	130°
Coolant Fed										
Substrate	HSS	HSS	HSS	HSS	Cobalt	Cobalt	Cobalt	Cobalt	Carbide	Carbide
Surface Finish	○	○●	○●	●S	○	●S	●S	○	○	○
Wrought aluminum	✓	✓	✓		✓		✓	✓	✓	✓
Cast aluminum <10% Si	✓	✓	✓		✓		✓	✓	✓	✓
Cast aluminum >10% Si	✓	✓	✓	✓	✓	✓	✓	✓	✓	✓
Size Range (mm)	0.20 - 20.00	0.60 - 16.00	1.00 - 12.70	1.00 - 16.00	1.00 - 14.29	1.00 - 13.00	1.00 - 14.29	5.00 - 20.00	1.00 - 12.70	3.17 - 12.70
Sizes page	79	146	149	174	273	183	265	204	199	230

Material group	Examples
Aluminium and Al-alloys	EC 1060, 1100, 1145, 1175, 1235, 2011, 2014, 2017, 2018, 2021, 2024, 2025, 2117, 2218, 2219, 2618, 3003, 3004, 3005, 4032, 4032-T6, 5005, 5050, 5052, 5056, 5083, 5086, 5154, 5252, 5254, 5454, 5456, 5457, 5652, 5657, 6053, 6061, 6061-T6, 6063, 6066, 6070, 6101, 6151, 6253, 6262, 6463, 6951, 7001, 7004, 7005, 7039, 7049, 7050, 7075, 7075-T6, 7079, 7175, 7178
Al wrought alloys	1100-0, 3003-H18, 5056-0, 2024-T4, 4043-H18
Al cast alloys	295-T6, 319-F, 356-T6, 380-F, 384-F, 390-F, 443-F, 413-F, 518-F, 713-TS, 850-TS



Extra Length ($\leq 10xD$) Drills

											
Series	6408 / 6412	5020 - 5026	219	535	501	390	5536	524	526	503	504
Length	8xD / 15xD	45mm FL - 160 mm FL	10xD	10xD	10xD	10xD	10xD	Extra #1	Extra #1	Extra #2	Extra #3
Shank											
Style	Micro	EB100	W	GT100	GT50	GT100	GU500DZ	GT50	GT100	GT100	GT100
Point Angle	140°	Special	130°	130°	130°	130°	118°	130°	130°	130°	130°
Coolant Fed											
Substrate	Carbide	Carbide	HSS	HSS	HSS	HSS	Cobalt	HSS	HSS	HSS	HSS
Surface Finish											
Wrought aluminum	✓	✓	✓	✓	✓	✓	✓	✓	✓	✓	✓
Cast aluminum <10% Si	✓	✓	✓	✓	✓	✓	✓	✓	✓	✓	✓
Cast aluminum >10% Si	✓	✓	✓	✓	✓	✓	✓	✓	✓	✓	✓
Size Range (mm)	1.40 - 3.00	1.20 - 8.00	0.40 - 20.00	1.00 - 14.00	1.00 - 14.00	3.00 - 13.00	1.00 - 14.29	2.00 - 12.70	8.00 - 30.16	2.30 - 13.00	2.50 - 13.00
Sizes page	300	252	88	143	130	129	279	138	139	134	135

Free toolfinder software

Find the best-suited Guhring cutting tools for your application -- quickly and easily -- with Guhring Navigator. Go to www.guhring.com and click on the icon to test drive this software.



High-Performance Drill Recommendations

Series	5514	6068	5511	609	6501	6069	6502	5512	6070	5525	4113 Insert	6509 - 6514
Length	3xD	4xD	5xD	5xD	5xD	7xD	7xD	7xD	10xD	12xD	3, 5, 7 x D	15xD - 40xD
Shank												
Style	RT100U	RT150GG	RT100U	GS200U 3-flute	RT100R	RT150GG	RT100R	RT100U	RT150GG	RT100C	HT800 / RT800WP	RT100T
Point Angle	140°	130°	140°	150°	Radius	130°	Radius	140°	130°	140°	140°	135°
Coolant Fed												
Substrate	Carbide	Carbide	Carbide	Carbide	Carbide	Carbide	Carbide	Carbide	Carbide	Carbide	Carbide	Carbide
Surface Finish	F	○	F	S	F	○	F	F	○	F	F	A
Cast iron	✓	✓	✓	✓	✓	✓	✓	✓	✓	✓	✓	✓
Spheroidal graphite and malleable cast	✓	✓	✓	✓	✓	✓	✓	✓	✓	✓	✓	✓
Chilled cast iron	✓		✓		✓		✓	✓			✓	
Size range (mm)	3.00 - 20.00	3.00 - 20.00	3.00 - 20.00	3.00 - 20.00	3.00 - 20.00	3.00 - 20.00	4.00 - 20.00	3.00 - 20.00	3.00 - 20.00	3.00 - 20.00	11.00 - 25.50	3.00 - 14.00
Sizes page	260	295	255	160	301	296	303	257	297	277	239	305-306

Material group	Examples
Cast iron	A48-20 B, A48-30 B, A48-40 B, A48-50B, A159G1800, A159G2500, A159G3000, A159G3500, A159G4000
Spheroidal graphite iron and malleable cast iron	60-10-18, 60-40-18, 65-45-12, 80-55-06, 100-70-03, 120-90-02, 32510, 35018, 40010, 50005, 60004, 70003, 80002, 90001, A220-70003, A220-8002, A536
Chilled cast iron	



Stub Length (3xD) Drills

Series	6400	301	660	223	226	653	659	5520	515	730	2463
Length	4xD	Micro	Micro	3xD	3xD (LH)	3xD	3xD	3xD	3xD	3xD	3xD
Shank											
Style	Micro	N	N	N	N	N	GV120	GU500DZ	GT500DZ	N	N
Point Angle	140°	118°	118°	118°	118°	118°	130°	118°	130°	118°	118°
Coolant Fed											
Substrate	Carbide	Cobalt	Cobalt	HSS	HSS	HSS	Cobalt	Cobalt	PM-Cobalt	Carbide	Carbide
Surface Finish	A		S			S	S	S	F		F
Cast iron	✓	✓	✓	✓	✓	✓	✓	✓	✓	✓	✓
Spheroidal graphite and malleable cast	✓	✓	✓	✓	✓	✓	✓	✓	✓	✓	✓
Chilled cast iron							✓		✓		✓
Size range (mm)	0.50 - 3.00	0.05 - 1.92	0.128 - 1.80	0.40 - 31.75	0.50 - 44.45	0.50 - 28.50	0.50 - 15.50	1.00 - 14.29	1.00 - 14.29	0.50 - 16.00	1.00 - 16.00
Sizes page	298	111	187	90	98	176	185	267	136	197	222















































Free toolfinder software

Find the best-suited Gühring cutting tools for your application -- quickly and easily -- with Gühring Navigator. Go to www.guhring.com and click on the icon to test drive this software.





Jobber Length (5xD) Drills

											
Series	205	208	651	549	652	658	5519	657	1132	732	2464
Length	5xD	5xD (LH)	5xD	5xD	5xD	5xD	5xD	5xD	5xD	5xD	5xD
Shank											
Style	N	N	N	GT100	GT100	GT100	GU500DZ	Ti	GT80	N	N
Point Angle	118°	118°	118°	130°	130°	130°	118°	130°	130°	118°	118°
Coolant Fed											
Substrate	HSS	HSS	HSS	HSS	HSS	Cobalt	Cobalt	Cobalt	Cobalt	Carbide	Carbide
Surface Finish	 	 		 							
Cast iron	✓	✓	✓	✓	✓	✓	✓		✓	✓	✓
Spheroidal graphite and malleable cast	✓	✓	✓	✓	✓	✓	✓		✓	✓	✓
Chilled cast iron								✓	✓		✓
Size range (mm)	0.20 - 20.00	0.24 - 16.00	0.20 - 19.00	0.60 - 16.00	1.00 - 16.00	1.00 - 13.00	1.00 - 14.29	0.50 - 13.00	5.00 - 20.00	1.00 - 12.70	1.00 - 12.70
Sizes page	71	82	170	146	174	183	265	181	205	199	224

Material group	Examples
Cast iron	A48-20 B, A48-30 B, A48-40 B, A48-50B, A159G1800, A159G2500, A159G3000, A159G3500, A159G4000
Spheroidal graphite iron and malleable cast iron	60-10-18, 60-40-18, 65-45-12, 80-55-06, 100-70-03, 120-90-02, 32510, 35018, 40010, 50005, 60004, 70003, 80002, 90001, A220-70003, A220-8002, A536
Chilled cast iron	



Extra Length ($\leq 10xD$) Drills

































Series	6408 / 6412	5020 - 5026	654	5537	336	669	670	526	671	504
Length	8xD / 15xD	45mm FL - 160 mm FL	10xD	10xD	10xD	10xD	Extra #1	Extra #1	Extra #2	Extra #3
Shank										
Style	Micro	EB100	N	GU500DZ	GT100	Ti	GT100	GT100	GT100	GT100
Point Angle	140°	Special	118°	118°	130°	130°	130°	130°	130°	130°
Coolant Fed										
Substrate	Carbide	Carbide	HSS	Cobalt	Cobalt	Cobalt	HSS	HSS	HSS	HSS
Surface Finish	○	○	Ⓢ	Ⓢ	○●	Ⓢ	Ⓢ	○●	Ⓢ	●
Cast iron	✓	✓	✓	✓	✓		✓	✓	✓	✓
Spheroidal graphite and malleable cast	✓	✓	✓	✓	✓		✓	✓	✓	✓
Chilled cast iron						✓	✓		✓	
Size range (mm)	1.40 - 3.00	1.20 - 8.00	3.00 - 30.50	1.00 - 14.29	1.00 - 12.00	1.00 - 10.00	1.98 - 12.50	8.00 - 30.16	3.00 - 8.00	2.50 - 13.00
Sizes page	300	252	179	281	126	194	195	139	196	135

Free toolfinder software

Find the best-suited Guhring cutting tools for your application -- quickly and easily -- with Guhring Navigator. Go to www.guhring.com and click on the icon to test drive this software.































High-Performance Drill Recommendations

Series	5741	8524	8520	8510	5744	8521	8511	609	5746	8522	4112 Insert
Length	3xD	3xD	3xD	3xD	5xD	5xD	5xD	5xD	7xD	7xD	3, 5, 7 x D
Shank											
Style	RT100US	RT100HF	RT100HF	RT100VA	RT100US	RT100HF	RT100VA	GS200U 3-flute	RT100US	RT100HF	HT800 / RT800WP
Point Angle	140°	130°	140°	140°	140°	140°	140°	150°	140°	140°	140°
Coolant Fed											
Substrate	Carbide	Carbide	Carbide	Carbide	Carbide	Carbide	Carbide	Carbide	Carbide	Carbide	Carbide
Surface Finish											
Special alloys	√	√	√	√	√	√	√	√	√	√	√
Ti and Ti-alloys	√	√	√	√	√	√	√	√	√	√	√
Magnesium alloys	√	√	√	√	√	√	√	√	√	√	√
Size Range (mm)	3.00 - 12.70	3.00 - 20.00	3.00 - 20.00	3.00 - 20.00	3.00 - 12.70	3.00 - 20.00	3.00 - 20.00	3.00 - 20.00	3.00 - 12.70	3.00 - 16.00	11.00-25.50
Sizes page	290	316	311	307	292	313	309	160	294	315	239

Material group	Examples
Special alloys	Inconel, Hastelloy, Monel, Nimonic, MAR-M246, DS-Ni, Waspalloy, Rene41
Ti and Ti-alloys	Ti6AL4V, 5390A, TiCu2
Magnesium alloys	AZ31B, AZ63A, AZ80A, AZ91C, EZ33A, HK31A, QE22A, ZK60A



Stub Length (3xD) Drills





















							
Series	6400	610	329	659	5520	515	2463
Length	4xD	3xD	3xD	3xD	3xD	3xD	3xD
Shank							
Style	Micro	Ti	GV120	GV120	GU500DZ	GT500DZ	N
Point Angle	140°	130°	130°	130°	118°	130°	118°
Coolant Fed							
Substrate	Carbide	Cobalt	Cobalt	Cobalt	Cobalt	PM-Cobalt	Carbide
Surface Finish							
Special alloys	✓	✓		✓	✓	✓	
Ti and Ti-alloys	✓	✓		✓	✓	✓	✓
Magnesium alloys	✓	✓	✓	✓	✓	✓	✓
Size Range (mm)	0.50 - 3.00	1.00 - 14.29	0.40 - 25.40	0.50 - 15.50	1.00 - 14.29	1.00 - 14.29	1.00 - 16.00
Sizes page	298	162	123	185	267	136	222

Free toolfinder software

Find the best-suited Guhring cutting tools for your application -- quickly and easily -- with Guhring Navigator. Go to www.guhring.com and click on the icon to test drive this software.



Jobber Length (5xD) Drills

Series	6401	605	657	658	1223	530	2464
Length	7xD	5xD	5xD	5xD	5xD	5xD	5xD
Shank							
Style	Micro	Ti	Ti	GT100	GT100	GT500DZ	N
Point Angle	140°	130°	130°	130°	130°	130°	118°
Coolant Fed							
Substrate	Carbide	Cobalt	Cobalt	Cobalt	Cobalt	PM-Cobalt	Carbide
Surface Finish							
Special alloys	✓		✓			✓	
Ti and Ti-alloys	✓	✓				✓	✓
Magnesium alloys	✓	✓	✓	✓	✓	✓	✓
Size Range (mm)	0.50 - 3.00	0.30 - 19.05	0.50 - 13.00	1.00 - 13.00	3.00 - 12.00	1.00 - 14.29	1.00 - 12.70
Sizes page	298	157	181	183	211	141	224

Material group	Examples
Special alloys	Inconel, Hastelloy, Monel, Nimonic, MAR-M246, DS-Ni, Waspalloy, Rene41
Ti and Ti-alloys	Ti6AL4V, 5390A, TiCu2
Magnesium alloys	AZ31B, AZ63A, AZ80A, AZ91C, EZ33A, HK31A, OE22A, ZK60A



Extra Length ($\leq 10xD$) Drills

Series	6408 / 6412	5020 - 5026	617	669	336	618	619	6511 - 6514
Length	8xD / 15xD	45mm FL - 160 mm FL	10xD	10xD	10xD	Extra #1	Extra #2	20xD - 40xD
Shank								
Style	Micro	EB100	Ti	Ti	GT100	GT100	GT100	RT100T
Point Angle	140°	Special	130°	130°	130°	130°	130°	135°
Coolant Fed								
Substrate	Carbide	Carbide	Cobalt	Cobalt	Cobalt	Cobalt	Cobalt	Carbide
Surface Finish								
Special alloys	✓	✓		✓	✓	✓	✓	✓
Ti and Ti-alloys	✓	✓	✓	✓	✓	✓	✓	
Magnesium alloys	✓	✓		✓	✓	✓	✓	✓
Size Range (mm)	1.40 - 3.00	1.20 - 8.00	1.00 - 15.87	1.00 - 10.00	1.00 - 12.00	2.70 - 10.00	3.00 - 10.00	3.00 - 14.00
Sizes page	300	252	164	194	126	166	167	305-306

Free toolfinder software

Find the best-suited Guhring cutting tools for your application -- quickly and easily -- with Guhring Navigator. Go to www.guhring.com and click on the icon to test drive this software.



Standard Drill Offering



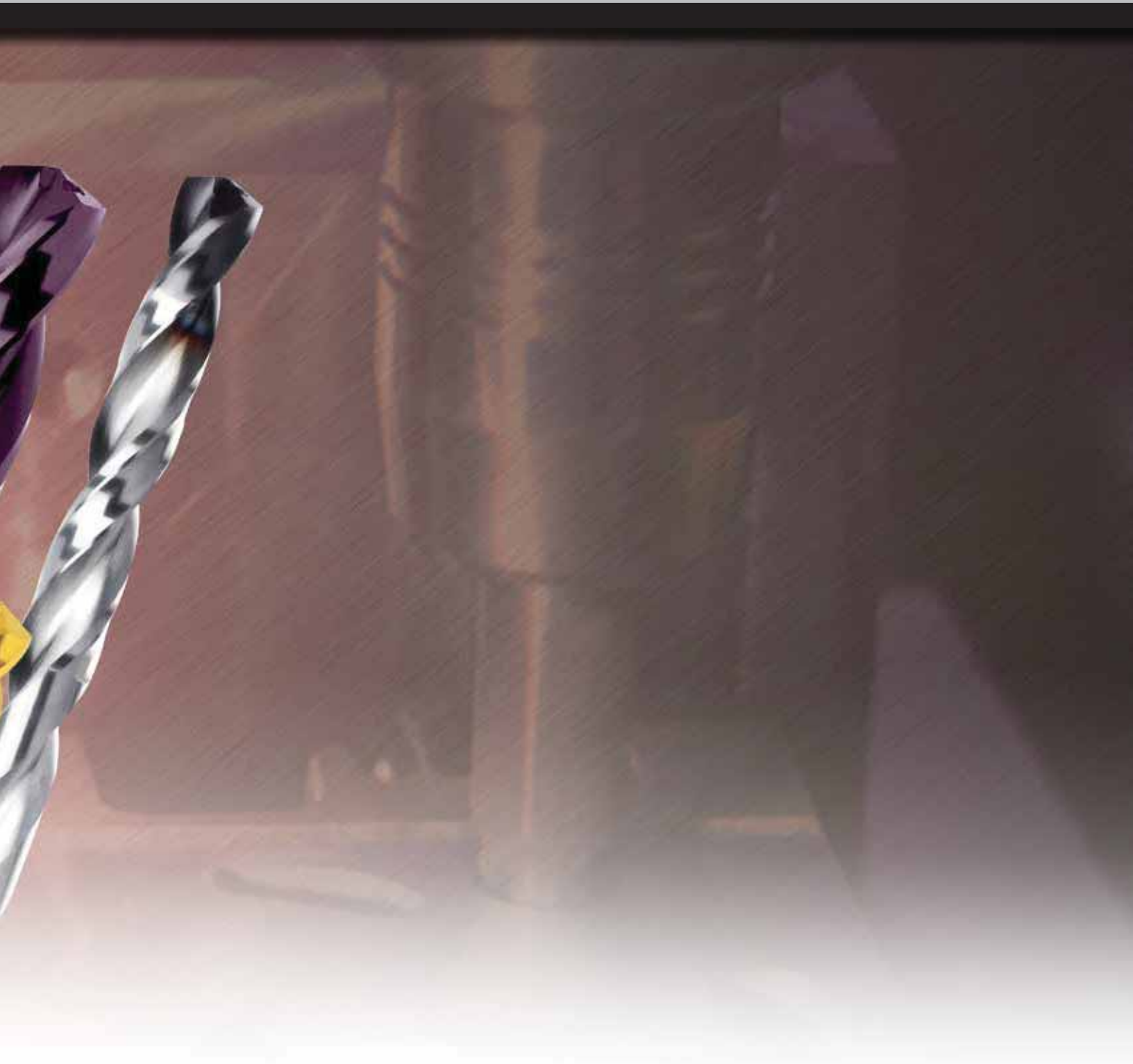

3xD**Series 160 (Diamond Coated) & 170 (Bright)**

Application Materials:



Diamond Coated



External Coolant



Straight Shank

90° Drill for Composite Materials

Carbide, 90° faceted point geometry, diamond coated tip

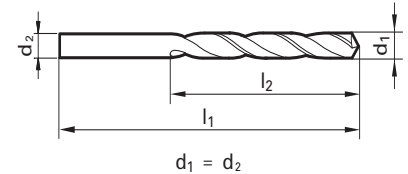
Diameter tolerance $-.0005"$ / Shank tolerance h6Contact Tech Support
for feeds & speeds

Dec. inch	Diameter (d1)			l1 mm	l2 mm	Series 160 Order Code (Diamond Coated)	Series 170 Order Code (Bright)
	Fract. inch	Wire / letter	mm				
0.0980			2.489	43.00	14.00	344001454	380258770
0.1285			3.264	49.00	18.00	344001455	380258771
0.1420			3.607	52.00	20.00	344001456	380258772
0.1665		19*	4.229	58.00	24.00	344001457	380258773
0.1734		17*	4.404	58.00	24.00	344001458	380247152
0.1915			4.864	62.00	26.00	344001459	380247153
0.2220			5.639	66.00	28.00	344001460	380258776
0.2510	1/4*		6.375	70.00	31.00	344001461	380247154
0.3135	5/16*		7.963	79.00	37.00	344001462	380247155
0.3760	3/8*		9.550	89.00	43.00	344001463	380247156
0.4385	7/16*		11.138	95.00	47.00	344001464	380258782
0.5010	1/2*		12.725	102.00	51.00	344001465	380247159

*Approximate final hole size

Material-specific design and grade to machine carbon fiber-reinforced polymer (CFRP) composite materials by minimizing delamination and increasing tool life.

Special 90° point angle increases hole quality, with low thrust and improved hole quality.

Diamond coated for resistance to abrasion wear. Combination of point design, substrate, and coating provides longer tool life with substantially less cutting force.



5xD



 Steam Oxide

 >2.36 mm dia.



 External Coolant



 Straight Shank

Speeds & Feeds

 information pg 424

Series 205



General Purpose

HSS, general purpose (Type N), jobber length, 118° point, Form A web thinned >2.36mm dia., standard straight shank, RH helix

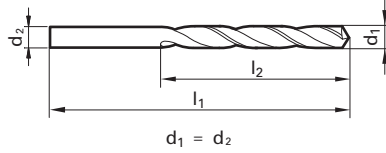
Cut / Shank Dia. = h8 tolerance range



Application Materials:

-  General Steels / Brass
-  Universal Steels
-  Cast Iron

Twist Drills



Dec. inch	Diameter (d1)			l1 mm	l2 mm	EDP #
	Fract. inch	Wire / letter	mm			
0.0079		92	0.200	19.00	2.50	9002050002000
0.0083		91	0.210	19.00	2.50	9002050002100
0.0087		90	0.220	19.00	2.50	9002050002200
0.0091		89	0.230	19.00	2.50	9002050002300
0.0094		88	0.240	19.00	2.50	9002050002400
0.0098		87	0.250	19.00	3.00	9002050002500
0.0102			0.260	19.00	3.00	9002050002600
0.0106		86	0.270	19.00	3.00	9002050002700
0.0110		85	0.280	19.00	3.00	9002050002800
0.0114		84	0.290	19.00	3.00	9002050002900
0.0118			0.300	19.00	3.00	9002050003000
0.0122		83	0.310	19.00	4.00	9002050003100
0.0126		82	0.320	19.00	4.00	9002050003200
0.0130		81	0.330	19.00	4.00	9002050003300
0.0134		80	0.340	19.00	4.00	9002050003400
0.0138			0.350	19.00	4.00	9002050003500
0.0142			0.360	19.00	4.00	9002050003600
0.0146		79	0.370	19.00	4.00	9002050003700
0.0150			0.380	19.00	4.00	9002050003800
0.0154			0.390	20.00	5.00	9002050003900
0.0157	1/64		0.400	20.00	5.00	9002050004000
0.0161		78	0.410	20.00	5.00	9002050004100
0.0165			0.420	20.00	5.00	9002050004200
0.0169			0.430	20.00	5.00	9002050004300
0.0173			0.440	20.00	5.00	9002050004400
0.0177			0.450	20.00	5.00	9002050004500
0.0181		77	0.460	20.00	5.00	9002050004600
0.0185			0.470	20.00	5.00	9002050004700
0.0189			0.480	20.00	5.00	9002050004800
0.0193			0.490	22.00	6.00	9002050004900
0.0197			0.500	22.00	6.00	9002050005000
0.0201		76	0.510	22.00	6.00	9002050005100
0.0205			0.520	22.00	6.00	9002050005200
0.0209		75	0.530	22.00	6.00	9002050005300
0.0213			0.540	24.00	7.00	9002050005400
0.0217			0.550	24.00	7.00	9002050005500
0.0220			0.560	24.00	7.00	9002050005600
0.0224		74	0.570	24.00	7.00	9002050005700
0.0228			0.580	24.00	7.00	9002050005800
0.0232			0.590	24.00	7.00	9002050005900
0.0236			0.600	24.00	7.00	9002050006000
0.0240		73	0.610	26.00	8.00	9002050006100
0.0244			0.620	26.00	8.00	9002050006200
0.0248			0.630	26.00	8.00	9002050006300
0.0252		72	0.640	26.00	8.00	9002050006400
0.0256			0.650	26.00	8.00	9002050006500
0.0260		71	0.660	26.00	8.00	9002050006600
0.0264			0.670	26.00	8.00	9002050006700
0.0268			0.680	28.00	9.00	9002050006800
0.0272			0.690	28.00	9.00	9002050006900
0.0276			0.700	28.00	9.00	9002050007000
0.0280		70	0.710	28.00	9.00	9002050007100
0.0283			0.720	28.00	9.00	9002050007200
0.0287			0.730	28.00	9.00	9002050007300

Dec. inch	Diameter (d1)			l1 mm	l2 mm	EDP #
	Fract. inch	Wire / letter	mm			
0.0291		69	0.740	28.00	9.00	9002050007400
0.0295			0.750	28.00	9.00	9002050007500
0.0299			0.760	30.00	10.00	9002050007600
0.0303			0.770	30.00	10.00	9002050007700
0.0307			0.780	30.00	10.00	9002050007800
0.0311	1/32	68	0.790	30.00	10.00	9002050007900
0.0315			0.800	30.00	10.00	9002050008000
0.0319		67	0.810	30.00	10.00	9002050008100
0.0323			0.820	30.00	10.00	9002050008200
0.0327			0.830	30.00	10.00	9002050008300
0.0331		66	0.840	30.00	10.00	9002050008400
0.0335			0.850	30.00	10.00	9002050008500
0.0339			0.860	32.00	11.00	9002050008600
0.0343			0.870	32.00	11.00	9002050008700
0.0346			0.880	32.00	11.00	9002050008800
0.0350		65	0.890	32.00	11.00	9002050008900
0.0354			0.900	32.00	11.00	9002050009000
0.0358		64	0.910	32.00	11.00	9002050009100
0.0362			0.920	32.00	11.00	9002050009200
0.0366			0.930	32.00	11.00	9002050009300
0.0370		63	0.940	32.00	11.00	9002050009400
0.0374			0.950	32.00	11.00	9002050009500
0.0378			0.960	34.00	12.00	9002050009600
0.0382		62	0.970	34.00	12.00	9002050009700
0.0386			0.980	34.00	12.00	9002050009800
0.0390		61	0.990	34.00	12.00	9002050009900
0.0394			1.000	34.00	12.00	9002050010000
0.0398			1.010	34.00	12.00	9002050010100
0.0402		60	1.020	34.00	12.00	9002050010200
0.0406			1.030	34.00	12.00	9002050010300
0.0409		59	1.040	34.00	12.00	9002050010400
0.0413			1.050	34.00	12.00	9002050010500
0.0417			1.060	34.00	12.00	9002050010600
0.0421		58	1.070	36.00	14.00	9002050010700
0.0425			1.080	36.00	14.00	9002050010800
0.0429		57	1.090	36.00	14.00	9002050010900
0.0433			1.100	36.00	14.00	9002050011000
0.0437			1.110	36.00	14.00	9002050011100
0.0441			1.120	36.00	14.00	9002050011200
0.0445			1.130	36.00	14.00	9002050011300
0.0449			1.140	36.00	14.00	9002050011400
0.0453			1.150	36.00	14.00	9002050011500
0.0457			1.160	36.00	14.00	9002050011600
0.0461			1.170	36.00	14.00	9002050011700
0.0465		56	1.180	36.00	14.00	9002050011800
0.0469	3/64		1.190	38.00	16.00	9002050011900
0.0472			1.200	38.00	16.00	9002050012000
0.0476			1.210	38.00	16.00	9002050012100
0.0480			1.220	38.00	16.00	9002050012200
0.0484			1.230	38.00	16.00	9002050012300
0.0488			1.240	38.00	16.00	9002050012400
0.0492			1.250	38.00	16.00	9002050012500
0.0496			1.260	38.00	16.00	9002050012600
0.0500			1.270	38.00	16.00	9002050012700

*Items listed in red are non-stocked items, and may take 2 - 6 weeks to receive

Series 205

Speeds & Feeds information pg 424

Dec. inch	Diameter (d1)		l1 mm	l2 mm	EDP #	
	Fract. inch	Wire / letter				
0.0504			1.280	38.00	16.00	9002050012800
0.0508			1.290	38.00	16.00	9002050012900
0.0512			1.300	38.00	16.00	9002050013000
0.0516			1.310	38.00	16.00	9002050013100
0.0520		55	1.320	38.00	16.00	9002050013200
0.0524			1.330	40.00	18.00	9002050013300
0.0528			1.340	40.00	18.00	9002050013400
0.0531			1.350	40.00	18.00	9002050013500
0.0535			1.360	40.00	18.00	9002050013600
0.0539			1.370	40.00	18.00	9002050013700
0.0543			1.380	40.00	18.00	9002050013800
0.0547			1.390	40.00	18.00	9002050013900
0.0551		54	1.400	40.00	18.00	9002050014000
0.0555			1.410	40.00	18.00	9002050014100
0.0559			1.420	40.00	18.00	9002050014200
0.0563			1.430	40.00	18.00	9002050014300
0.0567			1.440	40.00	18.00	9002050014400
0.0571			1.450	40.00	18.00	9002050014500
0.0575			1.460	40.00	18.00	9002050014600
0.0579			1.470	40.00	18.00	9002050014700
0.0583			1.480	40.00	18.00	9002050014800
0.0587			1.490	40.00	18.00	9002050014900
0.0591			1.500	40.00	18.00	9002050015000
0.0594		53	1.510	43.00	20.00	9002050015100
0.0598			1.520	43.00	20.00	9002050015200
0.0602			1.530	43.00	20.00	9002050015300
0.0606			1.540	43.00	20.00	9002050015400
0.0610			1.550	43.00	20.00	9002050015500
0.0614			1.560	43.00	20.00	9002050015600
0.0618			1.570	43.00	20.00	9002050015700
0.0622			1.580	43.00	20.00	9002050015800
0.0626	1/16		1.590	43.00	20.00	9002050015900
0.0630			1.600	43.00	20.00	9002050016000
0.0634		52	1.610	43.00	20.00	9002050016100
0.0638			1.620	43.00	20.00	9002050016200
0.0642			1.630	43.00	20.00	9002050016300
0.0646			1.640	43.00	20.00	9002050016400
0.0650			1.650	43.00	20.00	9002050016500
0.0654			1.660	43.00	20.00	9002050016600
0.0657			1.670	43.00	20.00	9002050016700
0.0661			1.680	43.00	20.00	9002050016800
0.0665			1.690	43.00	20.00	9002050016900
0.0669		51	1.700	43.00	20.00	9002050017000
0.0673			1.710	46.00	22.00	9002050017100
0.0677			1.720	46.00	22.00	9002050017200
0.0681			1.730	46.00	22.00	9002050017300
0.0685			1.740	46.00	22.00	9002050017400
0.0689			1.750	46.00	22.00	9002050017500
0.0693			1.760	46.00	22.00	9002050017600
0.0697			1.770	46.00	22.00	9002050017700
0.0701		50	1.780	46.00	22.00	9002050017800
0.0705			1.790	46.00	22.00	9002050017900
0.0709			1.800	46.00	22.00	9002050018000
0.0713			1.810	46.00	22.00	9002050018100
0.0717			1.820	46.00	22.00	9002050018200
0.0720			1.830	46.00	22.00	9002050018300
0.0724			1.840	46.00	22.00	9002050018400
0.0728		49	1.850	46.00	22.00	9002050018500
0.0732			1.860	46.00	22.00	9002050018600
0.0736			1.870	46.00	22.00	9002050018700
0.0740			1.880	46.00	22.00	9002050018800
0.0744			1.890	46.00	22.00	9002050018900
0.0748			1.900	46.00	22.00	9002050019000
0.0752			1.910	49.00	24.00	9002050019100
0.0756			1.920	49.00	24.00	9002050019200
0.0760		48	1.930	49.00	24.00	9002050019300
0.0764			1.940	49.00	24.00	9002050019400
0.0768			1.950	49.00	24.00	9002050019500
0.0772			1.960	49.00	24.00	9002050019600
0.0776			1.970	49.00	24.00	9002050019700

Dec. inch	Diameter (d1)		l1 mm	l2 mm	EDP #	
	Fract. inch	Wire / letter				
0.0780	5/64		1.980	49.00	24.00	9002050019800
0.0783		47	1.990	49.00	24.00	9002050019900
0.0787			2.000	49.00	24.00	9002050020000
0.0795			2.020	49.00	24.00	9002050020200
0.0799			2.030	49.00	24.00	9002050020300
0.0807			2.050	49.00	24.00	9002050020500
0.0811		46	2.060	49.00	24.00	9002050020600
0.0815			2.070	49.00	24.00	9002050020700
0.0819		45	2.080	49.00	24.00	9002050020800
0.0823			2.090	49.00	24.00	9002050020900
0.0827			2.100	49.00	24.00	9002050021000
0.0831			2.110	49.00	24.00	9002050021100
0.0839			2.130	53.00	27.00	9002050021300
0.0843			2.140	53.00	27.00	9002050021400
0.0846			2.150	53.00	27.00	9002050021500
0.0854			2.170	53.00	27.00	9002050021700
0.0858		44	2.180	53.00	27.00	9002050021800
0.0866			2.200	53.00	27.00	9002050022000
0.0882			2.240	53.00	27.00	9002050022400
0.0886			2.250	53.00	27.00	9002050022500
0.0890		43	2.260	53.00	27.00	9002050022600
0.0894			2.270	53.00	27.00	9002050022700
0.0902			2.290	53.00	27.00	9002050022900
0.0906			2.300	53.00	27.00	9002050023000
0.0913			2.320	53.00	27.00	9002050023200
0.0921			2.340	53.00	27.00	9002050023400
0.0925			2.350	53.00	27.00	9002050023500
0.0929			2.360	53.00	27.00	9002050023600
0.0933		42	2.370	57.00	30.00	9002050023700
0.0937	3/32		2.380	57.00	30.00	9002050023800
0.0941			2.390	57.00	30.00	9002050023900
0.0945			2.400	57.00	30.00	9002050024000
0.0953			2.420	57.00	30.00	9002050024200
0.0957			2.430	57.00	30.00	9002050024300
0.0961		41	2.440	57.00	30.00	9002050024400
0.0965			2.450	57.00	30.00	9002050024500
0.0969			2.460	57.00	30.00	9002050024600
0.0972			2.470	57.00	30.00	9002050024700
0.0976			2.480	57.00	30.00	9002050024800
0.0980		40	2.490	57.00	30.00	9002050024900
0.0984			2.500	57.00	30.00	9002050025000
0.0988			2.510	57.00	30.00	9002050025100
0.0992			2.520	57.00	30.00	9002050025200
0.0996		39	2.530	57.00	30.00	9002050025300
0.1000			2.540	57.00	30.00	9002050025400
0.1004			2.550	57.00	30.00	9002050025500
0.1012			2.570	57.00	30.00	9002050025700
0.1016		38	2.580	57.00	30.00	9002050025800
0.1024			2.600	57.00	30.00	9002050026000
0.1031			2.620	57.00	30.00	9002050026200
0.1039		37	2.640	57.00	30.00	9002050026400
0.1043			2.650	57.00	30.00	9002050026500
0.1051			2.670	61.00	33.00	9002050026700
0.1055			2.680	61.00	33.00	9002050026800
0.1063			2.700	61.00	33.00	9002050027000
0.1067		36	2.710	61.00	33.00	9002050027100
0.1071			2.720	61.00	33.00	9002050027200
0.1075			2.730	61.00	33.00	9002050027300
0.1083			2.750	61.00	33.00	9002050027500
0.1087			2.760	61.00	33.00	9002050027600
0.1094	7/64		2.780	61.00	33.00	9002050027800
0.1098		35	2.790	61.00	33.00	9002050027900
0.1102			2.800	61.00	33.00	9002050028000
0.1110		34	2.820	61.00	33.00	9002050028200
0.1122			2.850	61.00	33.00	9002050028500
0.1130		33	2.870	61.00	33.00	9002050028700
0.1134			2.880	61.00	33.00	9002050028800
0.1142			2.900	61.00	33.00	9002050029000
0.1146			2.910	61.00	33.00	9002050029100
0.1154			2.930	61.00	33.00	9002050029300

Series 205

Speeds & Feeds information pg 424

Twist Drills

Diameter (d1)			11 mm	12 mm	EDP #	
Dec. inch	Fract. inch	Wire / letter				
0.1161		32	2.950	61.00	33.00	9002050029500
0.1165			2.960	61.00	33.00	9002050029600
0.1173			2.980	61.00	33.00	9002050029800
0.1177			2.990	61.00	33.00	9002050029900
0.1181			3.000	61.00	33.00	9002050030000
0.1185			3.010	65.00	36.00	9002050030100
0.1197			3.040	65.00	36.00	9002050030400
0.1201		31	3.050	65.00	36.00	9002050030500
0.1209			3.070	65.00	36.00	9002050030700
0.1213			3.080	65.00	36.00	9002050030800
0.1220			3.100	65.00	36.00	9002050031000
0.1228			3.120	65.00	36.00	9002050031200
0.1232			3.130	65.00	36.00	9002050031300
0.1240			3.150	65.00	36.00	9002050031500
0.1244			3.160	65.00	36.00	9002050031600
0.1248	1/8		3.170	65.00	36.00	9002050031700
0.1252			3.180	65.00	36.00	9002050031800
0.1260			3.200	65.00	36.00	9002050032000
0.1268			3.220	65.00	36.00	9002050032200
0.1272			3.230	65.00	36.00	9002050032300
0.1280			3.250	65.00	36.00	9002050032500
0.1283		30	3.260	65.00	36.00	9002050032600
0.1299			3.300	65.00	36.00	9002050033000
0.1307			3.320	65.00	36.00	9002050033200
0.1319			3.350	65.00	36.00	9002050033500
0.1339			3.400	70.00	39.00	9002050034000
0.1346			3.420	70.00	39.00	9002050034200
0.1358		29	3.450	70.00	39.00	9002050034500
0.1378			3.500	70.00	39.00	9002050035000
0.1386			3.520	70.00	39.00	9002050035200
0.1398			3.550	70.00	39.00	9002050035500
0.1406	9/64	28	3.570	70.00	39.00	9002050035700
0.1417			3.600	70.00	39.00	9002050036000
0.1421			3.610	70.00	39.00	9002050036100
0.1425			3.620	70.00	39.00	9002050036200
0.1437			3.650	70.00	39.00	9002050036500
0.1441		27	3.660	70.00	39.00	9002050036600
0.1449			3.680	70.00	39.00	9002050036800
0.1457			3.700	70.00	39.00	9002050037000
0.1469		26	3.730	70.00	39.00	9002050037300
0.1476			3.750	70.00	39.00	9002050037500
0.1496		25	3.800	75.00	43.00	9002050038000
0.1504			3.820	75.00	43.00	9002050038200
0.1516			3.850	75.00	43.00	9002050038500
0.1520		24	3.860	75.00	43.00	9002050038600
0.1535			3.900	75.00	43.00	9002050039000
0.1539		23	3.910	75.00	43.00	9002050039100
0.1547			3.930	75.00	43.00	9002050039300
0.1555			3.950	75.00	43.00	9002050039500
0.1563	5/32		3.970	75.00	43.00	9002050039700
0.1571		22	3.990	75.00	43.00	9002050039900
0.1575			4.000	75.00	43.00	9002050040000
0.1579			4.010	75.00	43.00	9002050040100
0.1591		21	4.040	75.00	43.00	9002050040400
0.1594			4.050	75.00	43.00	9002050040500
0.1598			4.060	75.00	43.00	9002050040600
0.1610		20	4.090	75.00	43.00	9002050040900
0.1614			4.100	75.00	43.00	9002050041000
0.1634			4.150	75.00	43.00	9002050041500
0.1654			4.200	75.00	43.00	9002050042000
0.1661		19	4.220	75.00	43.00	9002050042200
0.1673			4.250	75.00	43.00	9002050042500
0.1681			4.270	80.00	47.00	9002050042700
0.1693		18	4.300	80.00	47.00	9002050043000
0.1701			4.320	80.00	47.00	9002050043200
0.1713			4.350	80.00	47.00	9002050043500
0.1720	11/64		4.370	80.00	47.00	9002050043700
0.1728		17	4.390	80.00	47.00	9002050043900
0.1732			4.400	80.00	47.00	9002050044000
0.1740			4.420	80.00	47.00	9002050044200

Diameter (d1)			11 mm	12 mm	EDP #	
Dec. inch	Fract. inch	Wire / letter				
0.1752			4.450	80.00	47.00	9002050044500
0.1772		16	4.500	80.00	47.00	9002050045000
0.1780			4.520	80.00	47.00	9002050045200
0.1783			4.530	80.00	47.00	9002050045300
0.1791			4.550	80.00	47.00	9002050045500
0.1799		15	4.570	80.00	47.00	9002050045700
0.1811			4.600	80.00	47.00	9002050046000
0.1819		14	4.620	80.00	47.00	9002050046200
0.1831			4.650	80.00	47.00	9002050046500
0.1850		13	4.700	80.00	47.00	9002050047000
0.1870			4.750	80.00	47.00	9002050047500
0.1874	3/16		4.760	86.00	52.00	9002050047600
0.1890		12	4.800	86.00	52.00	9002050048000
0.1902			4.830	86.00	52.00	9002050048300
0.1909		11	4.850	86.00	52.00	9002050048500
0.1913			4.860	86.00	52.00	9002050048600
0.1929			4.900	86.00	52.00	9002050049000
0.1937		10	4.920	86.00	52.00	9002050049200
0.1949			4.950	86.00	52.00	9002050049500
0.1961		9	4.980	86.00	52.00	9002050049800
0.1969			5.000	86.00	52.00	9002050050000
0.1980			5.030	86.00	52.00	9002050050300
0.1988			5.050	86.00	52.00	9002050050500
0.1992		8	5.060	86.00	52.00	9002050050600
0.2008			5.100	86.00	52.00	9002050051000
0.2012		7	5.110	86.00	52.00	9002050051100
0.2028			5.150	86.00	52.00	9002050051500
0.2031	13/64		5.160	86.00	52.00	9002050051600
0.2039		6	5.180	86.00	52.00	9002050051800
0.2047			5.200	86.00	52.00	9002050052000
0.2055		5	5.220	86.00	52.00	9002050052200
0.2067			5.250	86.00	52.00	9002050052500
0.2087			5.300	86.00	52.00	9002050053000
0.2091		4	5.310	93.00	57.00	9002050053100
0.2106			5.350	93.00	57.00	9002050053500
0.2126			5.400	93.00	57.00	9002050054000
0.2130		3	5.410	93.00	57.00	9002050054100
0.2146			5.450	93.00	57.00	9002050054500
0.2165			5.500	93.00	57.00	9002050055000
0.2185			5.550	93.00	57.00	9002050055500
0.2189	7/32		5.560	93.00	57.00	9002050055600
0.2205			5.600	93.00	57.00	9002050056000
0.2209		2	5.610	93.00	57.00	9002050056100
0.2224			5.650	93.00	57.00	9002050056500
0.2244			5.700	93.00	57.00	9002050057000
0.2264			5.750	93.00	57.00	9002050057500
0.2280		1	5.790	93.00	57.00	9002050057900
0.2283			5.800	93.00	57.00	9002050058000
0.2303			5.850	93.00	57.00	9002050058500
0.2323			5.900	93.00	57.00	9002050059000
0.2339		A	5.940	93.00	57.00	9002050059400
0.2343	15/64		5.950	93.00	57.00	9002050059500
0.2350			5.970	93.00	57.00	9002050059700
0.2354			5.980	93.00	57.00	9002050059800
0.2362			6.000	93.00	57.00	9002050060000
0.2374			6.030	101.00	63.00	9002050060300
0.2378		B	6.040	101.00	63.00	9002050060400
0.2382			6.050	101.00	63.00	9002050060500
0.2402			6.100	101.00	63.00	9002050061000
0.2421		C	6.150	101.00	63.00	9002050061500
0.2441			6.200	101.00	63.00	9002050062000
0.2449			6.220	101.00	63.00	9002050062200
0.2461		D	6.250	101.00	63.00	9002050062500
0.2480			6.300	101.00	63.00	9002050063000
0.2500	1/4	E	6.350	101.00	63.00	9002050063500
0.2520			6.400	101.00	63.00	9002050064000
0.2539			6.450	101.00	63.00	9002050064500
0.2559			6.500	101.00	63.00	9002050065000
0.2571		F	6.530	101.00	63.00	9002050065300
0.2579			6.550	101.00	63.00	9002050065500

*Items listed in red are non-stocked items, and may take 2 - 6 weeks to receive

Series 205

Speeds & Feeds information pg 424

Twist Drills

Diameter (d1)			mm	I1 mm	I2 mm	EDP #
Dec. inch	Fract. inch	Wire / letter				
0.2598			6.600	101.00	63.00	9002050066000
0.2610		G	6.630	101.00	63.00	9002050066300
0.2618			6.650	101.00	63.00	9002050066500
0.2638			6.700	101.00	63.00	9002050067000
0.2657	17/64	H	6.750	109.00	69.00	9002050067500
0.2661			6.760	109.00	69.00	9002050067600
0.2677			6.800	109.00	69.00	9002050068000
0.2697			6.850	109.00	69.00	9002050068500
0.2717		I	6.900	109.00	69.00	9002050069000
0.2736			6.950	109.00	69.00	9002050069500
0.2756			7.000	109.00	69.00	9002050070000
0.2768		J	7.030	109.00	69.00	9002050070300
0.2776			7.050	109.00	69.00	9002050070500
0.2795			7.100	109.00	69.00	9002050071000
0.2811	9/32	K	7.140	109.00	69.00	9002050071400
0.2815			7.150	109.00	69.00	9002050071500
0.2835			7.200	109.00	69.00	9002050072000
0.2854			7.250	109.00	69.00	9002050072500
0.2874			7.300	109.00	69.00	9002050073000
0.2894			7.350	109.00	69.00	9002050073500
0.2902		L	7.370	109.00	69.00	9002050073700
0.2913			7.400	109.00	69.00	9002050074000
0.2933			7.450	109.00	69.00	9002050074500
0.2949		M	7.490	109.00	69.00	9002050074900
0.2953			7.500	109.00	69.00	9002050075000
0.2969	19/64		7.540	117.00	75.00	9002050075400
0.2972			7.550	117.00	75.00	9002050075500
0.2992			7.600	117.00	75.00	9002050076000
0.3012			7.650	117.00	75.00	9002050076500
0.3020		N	7.670	117.00	75.00	9002050076700
0.3031			7.700	117.00	75.00	9002050077000
0.3051			7.750	117.00	75.00	9002050077500
0.3071			7.800	117.00	75.00	9002050078000
0.3091			7.850	117.00	75.00	9002050078500
0.3110			7.900	117.00	75.00	9002050079000
0.3126	5/16		7.940	117.00	75.00	9002050079400
0.3130			7.950	117.00	75.00	9002050079500
0.3142			7.980	117.00	75.00	9002050079800
0.3150			8.000	117.00	75.00	9002050080000
0.3161		O	8.030	117.00	75.00	9002050080300
0.3169			8.050	117.00	75.00	9002050080500
0.3189			8.100	117.00	75.00	9002050081000
0.3201			8.130	117.00	75.00	9002050081300
0.3209			8.150	117.00	75.00	9002050081500
0.3228		P	8.200	117.00	75.00	9002050082000
0.3248			8.250	117.00	75.00	9002050082500
0.3268			8.300	117.00	75.00	9002050083000
0.3280	21/64		8.330	117.00	75.00	9002050083300
0.3287			8.350	117.00	75.00	9002050083500
0.3307			8.400	117.00	75.00	9002050084000
0.3319		Q	8.430	117.00	75.00	9002050084300
0.3327			8.450	117.00	75.00	9002050084500
0.3346			8.500	117.00	75.00	9002050085000
0.3366			8.550	125.00	81.00	9002050085500
0.3386			8.600	125.00	81.00	9002050086000
0.3390		R	8.610	125.00	81.00	9002050086100
0.3406			8.650	125.00	81.00	9002050086500
0.3425			8.700	125.00	81.00	9002050087000
0.3437	11/32		8.730	125.00	81.00	9002050087300
0.3445			8.750	125.00	81.00	9002050087500
0.3465			8.800	125.00	81.00	9002050088000
0.3480		S	8.840	125.00	81.00	9002050088400
0.3484			8.850	125.00	81.00	9002050088500
0.3504			8.900	125.00	81.00	9002050089000
0.3524			8.950	125.00	81.00	9002050089500
0.3543			9.000	125.00	81.00	9002050090000
0.3563			9.050	125.00	81.00	9002050090500
0.3579		T	9.090	125.00	81.00	9002050090900
0.3583			9.100	125.00	81.00	9002050091000
0.3594	23/64		9.130	125.00	81.00	9002050091300

Diameter (d1)			mm	I1 mm	I2 mm	EDP #
Dec. inch	Fract. inch	Wire / letter				
0.3602			9.150	125.00	81.00	9002050091500
0.3622			9.200	125.00	81.00	9002050092000
0.3642			9.250	125.00	81.00	9002050092500
0.3661			9.300	125.00	81.00	9002050093000
0.3677		U	9.340	125.00	81.00	9002050093400
0.3681			9.350	125.00	81.00	9002050093500
0.3701			9.400	125.00	81.00	9002050094000
0.3720			9.450	125.00	81.00	9002050094500
0.3740			9.500	125.00	81.00	9002050095000
0.3748	3/8		9.520	133.00	87.00	9002050095200
0.3760			9.550	133.00	87.00	9002050095500
0.3772		V	9.580	133.00	87.00	9002050095800
0.3780			9.600	133.00	87.00	9002050096000
0.3799			9.650	133.00	87.00	9002050096500
0.3819			9.700	133.00	87.00	9002050097000
0.3839			9.750	133.00	87.00	9002050097500
0.3858		W	9.800	133.00	87.00	9002050098000
0.3878			9.850	133.00	87.00	9002050098500
0.3898			9.900	133.00	87.00	9002050099000
0.3906	25/64		9.920	133.00	87.00	9002050099200
0.3917			9.950	133.00	87.00	9002050099500
0.3937			10.000	133.00	87.00	9002050100000
0.3953			10.040	133.00	87.00	9002050100400
0.3969		X	10.080	133.00	87.00	9002050100800
0.3976			10.100	133.00	87.00	9002050101000
0.3996			10.150	133.00	87.00	9002050101500
0.4016			10.200	133.00	87.00	9002050102000
0.4035			10.250	133.00	87.00	9002050102500
0.4039		Y	10.260	133.00	87.00	9002050102600
0.4055			10.300	133.00	87.00	9002050103000
0.4063	13/32		10.320	133.00	87.00	9002050103200
0.4075			10.350	133.00	87.00	9002050103500
0.4094			10.400	133.00	87.00	9002050104000
0.4130		Z	10.490	133.00	87.00	9002050104900
0.4134			10.500	133.00	87.00	9002050105000
0.4173			10.600	133.00	87.00	9002050106000
0.4213			10.700	142.00	94.00	9002050107000
0.4220	27/64		10.720	142.00	94.00	9002050107200
0.4232			10.750	142.00	94.00	9002050107500
0.4252			10.800	142.00	94.00	9002050108000
0.4291			10.900	142.00	94.00	9002050109000
0.4331			11.000	142.00	94.00	9002050110000
0.4350			11.050	142.00	94.00	9002050110500
0.4370			11.100	142.00	94.00	9002050111000
0.4374	7/16		11.110	142.00	94.00	9002050111100
0.4390			11.150	142.00	94.00	9002050111500
0.4409			11.200	142.00	94.00	9002050112000
0.4429			11.250	142.00	94.00	9002050112500
0.4449			11.300	142.00	94.00	9002050113000
0.4469			11.350	142.00	94.00	9002050113500
0.4488			11.400	142.00	94.00	9002050114000
0.4528			11.500	142.00	94.00	9002050115000
0.4531	29/64		11.510	142.00	94.00	9002050115100
0.4567			11.600	142.00	94.00	9002050116000
0.4606			11.700	142.00	94.00	9002050117000
0.4626			11.750	142.00	94.00	9002050117500
0.4646			11.800	142.00	94.00	9002050118000
0.4685			11.900	151.00	101.00	9002050119000
0.4689	15/32		11.910	151.00	101.00	9002050119100
0.4724			12.000	151.00	101.00	9002050120000
0.4744			12.050	151.00	101.00	9002050120500
0.4764			12.100	151.00	101.00	9002050121000
0.4803			12.200	151.00	101.00	9002050122000
0.4823			12.250	151.00	101.00	9002050122500
0.4843	31/64		12.300	151.00	101.00	9002050123000
0.4882			12.400	151.00	101.00	9002050124000
0.4921			12.500	151.00	101.00	9002050125000
0.4961			12.600	151.00	101.00	9002050126000
0.4980			12.650	151.00	101.00	9002050126500
0.5000	1/2		12.700	151.00	101.00	9002050127000

Series 205

Speeds & Feeds information pg 424

Dec. inch	Diameter (d1)		I1 mm	I2 mm	EDP #	
	Fract. inch	Wire / letter				
0.5020			12.750	151.00	101.00	9002050127500
0.5039			12.800	151.00	101.00	9002050128000
0.5059			12.850	151.00	101.00	9002050128500
0.5079			12.900	151.00	101.00	9002050129000
0.5118			13.000	151.00	101.00	9002050130000
0.5157	33/64		13.100	151.00	101.00	9002050131000
0.5197			13.200	151.00	101.00	9002050132000
0.5217			13.250	160.00	108.00	9002050132500
0.5236			13.300	160.00	108.00	9002050133000
0.5276			13.400	160.00	108.00	9002050134000
0.5311	17/32		13.490	160.00	108.00	9002050134900
0.5315			13.500	160.00	108.00	9002050135000
0.5354			13.600	160.00	108.00	9002050136000
0.5394			13.700	160.00	108.00	9002050137000
0.5413			13.750	160.00	108.00	9002050137500
0.5433			13.800	160.00	108.00	9002050138000
0.5469	35/64		13.890	160.00	108.00	9002050138900
0.5472			13.900	160.00	108.00	9002050139000
0.5512			14.000	160.00	108.00	9002050140000
0.5551			14.100	169.00	114.00	9002050141000
0.5591			14.200	169.00	114.00	9002050142000
0.5610			14.250	169.00	114.00	9002050142500
0.5626	9/16		14.290	169.00	114.00	9002050142900
0.5630			14.300	169.00	114.00	9002050143000
0.5669			14.400	169.00	114.00	9002050144000
0.5709			14.500	169.00	114.00	9002050145000
0.5748			14.600	169.00	114.00	9002050146000
0.5780	37/64		14.680	169.00	114.00	9002050146800
0.5787			14.700	169.00	114.00	9002050147000
0.5807			14.750	169.00	114.00	9002050147500
0.5827			14.800	169.00	114.00	9002050148000
0.5846			14.850	169.00	114.00	9002050148500
0.5866			14.900	169.00	114.00	9002050149000
0.5906			15.000	169.00	114.00	9002050150000
0.5937	19/32		15.080	178.00	120.00	9002050150800
0.5945			15.100	178.00	120.00	9002050151000
0.5984			15.200	178.00	120.00	9002050152000
0.6004			15.250	178.00	120.00	9002050152500
0.6024			15.300	178.00	120.00	9002050153000
0.6063			15.400	178.00	120.00	9002050154000
0.6094	39/64		15.480	178.00	120.00	9002050154800
0.6102			15.500	178.00	120.00	9002050155000
0.6142			15.600	178.00	120.00	9002050156000
0.6181			15.700	178.00	120.00	9002050157000
0.6201			15.750	178.00	120.00	9002050157500
0.6220			15.800	178.00	120.00	9002050158000
0.6248	5/8		15.870	178.00	120.00	9002050158700
0.6260			15.900	178.00	120.00	9002050159000
0.6299			16.000	178.00	120.00	9002050160000
0.6339			16.100	184.00	125.00	9002050161000
0.6378			16.200	184.00	125.00	9002050162000
0.6398			16.250	184.00	125.00	9002050162500
0.6406	41/64		16.270	184.00	125.00	9002050162700

Dec. inch	Diameter (d1)		I1 mm	I2 mm	EDP #	
	Fract. inch	Wire / letter				
0.6417			16.300	184.00	125.00	9002050163000
0.6457			16.400	184.00	125.00	9002050164000
0.6496			16.500	184.00	125.00	9002050165000
0.6535			16.600	184.00	125.00	9002050166000
0.6563	21/32		16.670	184.00	125.00	9002050166700
0.6575			16.700	184.00	125.00	9002050167000
0.6594			16.750	184.00	125.00	9002050167500
0.6614			16.800	184.00	125.00	9002050168000
0.6654			16.900	184.00	125.00	9002050169000
0.6693			17.000	184.00	125.00	9002050170000
0.6720	43/64		17.070	191.00	130.00	9002050170700
0.6772			17.200	191.00	130.00	9002050172000
0.6791			17.250	191.00	130.00	9002050172500
0.6811			17.300	191.00	130.00	9002050173000
0.6850			17.400	191.00	130.00	9002050174000
0.6874	11/16		17.460	191.00	130.00	9002050174600
0.6890			17.500	191.00	130.00	9002050175000
0.6929			17.600	191.00	130.00	9002050176000
0.6969			17.700	191.00	130.00	9002050177000
0.6988			17.750	191.00	130.00	9002050177500
0.7008			17.800	191.00	130.00	9002050178000
0.7031	45/64		17.860	191.00	130.00	9002050178600
0.7047			17.900	191.00	130.00	9002050179000
0.7087			18.000	191.00	130.00	9002050180000
0.7126			18.100	198.00	135.00	9002050181000
0.7165			18.200	198.00	135.00	9002050182000
0.7185			18.250	198.00	135.00	9002050182500
0.7189	23/32		18.260	198.00	135.00	9002050182600
0.7205			18.300	198.00	135.00	9002050183000
0.7244			18.400	198.00	135.00	9002050184000
0.7283			18.500	198.00	135.00	9002050185000
0.7343	47/64		18.650	198.00	135.00	9002050186500
0.7382			18.750	198.00	135.00	9002050187500
0.7402			18.800	198.00	135.00	9002050188000
0.7480			19.000	198.00	135.00	9002050190000
0.7500	3/4		19.050	205.00	140.00	9002050190500
0.7520			19.100	205.00	140.00	9002050191000
0.7559			19.200	205.00	140.00	9002050192000
0.7579			19.250	205.00	140.00	9002050192500
0.7677			19.500	205.00	140.00	9002050195000
0.7717			19.600	205.00	140.00	9002050196000
0.7776			19.750	205.00	140.00	9002050197500
0.7811	25/32		19.840	205.00	140.00	9002050198400
0.7874			20.000	205.00	140.00	9002050200000

Alternative Drill Series:

- #651 HSS, GP, 5xD, 118 pt, TiN
- #305 Cobalt, GP, 5xD, 118 pt, Oxide
- #732 Carbide, GP, 5xD, 130 pt, Bright
- #5523 Cobalt, GU500, 5xD, 118 pt, Bright
- #5519 Cobalt, GU500, 5xD, 118 pt, TiN

*Items listed in red are non-stocked items, and may take 2 - 6 weeks to receive

5xD



Bright Finish



External Coolant



Straight Shank

Speeds & Feeds
information pg 424

Series 206

Low Helix

HSS, Low Helix (Type H), jobber length, 118° point, Form A web thinned
>14.0mm dia., standard straight shank, RH helix

Cut / Shank Dia. = h8 tolerance range

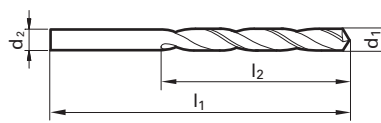

$$d_1 = d_2$$

Application Materials:

General Steels/
Brass

Dec. inch	Diameter (d1)		l1 mm	l2 mm	EDP #	
	Fract. inch	Wire / letter				mm
0.0079		92	0.200	19.00	2.50	9002060002000
0.0094		88	0.240	19.00	2.50	9002060002400
0.0098		87	0.250	19.00	3.00	9002060002500
0.0118			0.300	19.00	3.00	9002060003000
0.0134		80	0.340	19.00	4.00	9002060003400
0.0138			0.350	19.00	4.00	9002060003500
0.0157	1/64		0.400	20.00	5.00	9002060004000
0.0161		78	0.410	20.00	5.00	9002060004100
0.0177			0.450	20.00	5.00	9002060004500
0.0181		77	0.460	20.00	5.00	9002060004600
0.0197			0.500	22.00	6.00	9002060005000
0.0201		76	0.510	22.00	6.00	9002060005100
0.0209		75	0.530	22.00	6.00	9002060005300
0.0217			0.550	24.00	7.00	9002060005500
0.0224		74	0.570	24.00	7.00	9002060005700
0.0236			0.600	24.00	7.00	9002060006000
0.0244			0.620	26.00	8.00	9002060006200
0.0256			0.650	26.00	8.00	9002060006500
0.0260		71	0.660	26.00	8.00	9002060006600
0.0276			0.700	28.00	9.00	9002060007000
0.0283			0.720	28.00	9.00	9002060007200
0.0287			0.730	28.00	9.00	9002060007300
0.0291		69	0.740	28.00	9.00	9002060007400
0.0295			0.750	28.00	9.00	9002060007500
0.0299			0.760	30.00	10.00	9002060007600
0.0303			0.770	30.00	10.00	9002060007700
0.0311	1/32	68	0.790	30.00	10.00	9002060007900
0.0315			0.800	30.00	10.00	9002060008000
0.0319		67	0.810	30.00	10.00	9002060008100
0.0327			0.830	30.00	10.00	9002060008300
0.0331		66	0.840	30.00	10.00	9002060008400
0.0335			0.850	30.00	10.00	9002060008500
0.0339			0.860	32.00	11.00	9002060008600
0.0343			0.870	32.00	11.00	9002060008700
0.0346			0.880	32.00	11.00	9002060008800
0.0350		65	0.890	32.00	11.00	9002060008900
0.0354			0.900	32.00	11.00	9002060009000
0.0358		64	0.910	32.00	11.00	9002060009100
0.0366			0.930	32.00	11.00	9002060009300
0.0374			0.950	32.00	11.00	9002060009500
0.0378			0.960	34.00	12.00	9002060009600
0.0382		62	0.970	34.00	12.00	9002060009700
0.0390		61	0.990	34.00	12.00	9002060009900
0.0394			1.000	34.00	12.00	9002060010000
0.0402		60	1.020	34.00	12.00	9002060010200
0.0409		59	1.040	34.00	12.00	9002060010400
0.0413			1.050	34.00	12.00	9002060010500
0.0433			1.100	36.00	14.00	9002060011000
0.0453			1.150	36.00	14.00	9002060011500
0.0465		56	1.180	36.00	14.00	9002060011800
0.0469	3/64		1.190	38.00	16.00	9002060011900
0.0472			1.200	38.00	16.00	9002060012000
0.0480			1.220	38.00	16.00	9002060012200
0.0492			1.250	38.00	16.00	9002060012500
0.0500			1.270	38.00	16.00	9002060012700

Dec. inch	Diameter (d1)		l1 mm	l2 mm	EDP #	
	Fract. inch	Wire / letter				mm
0.0504			1.280	38.00	16.00	9002060012800
0.0512			1.300	38.00	16.00	9002060013000
0.0520		55	1.320	38.00	16.00	9002060013200
0.0524			1.330	40.00	18.00	9002060013300
0.0531			1.350	40.00	18.00	9002060013500
0.0539			1.370	40.00	18.00	9002060013700
0.0551		54	1.400	40.00	18.00	9002060014000
0.0563			1.430	40.00	18.00	9002060014300
0.0567			1.440	40.00	18.00	9002060014400
0.0571			1.450	40.00	18.00	9002060014500
0.0579			1.470	40.00	18.00	9002060014700
0.0591			1.500	40.00	18.00	9002060015000
0.0602			1.530	43.00	20.00	9002060015300
0.0606			1.540	43.00	20.00	9002060015400
0.0610			1.550	43.00	20.00	9002060015500
0.0626	1/16		1.590	43.00	20.00	9002060015900
0.0630			1.600	43.00	20.00	9002060016000
0.0638			1.620	43.00	20.00	9002060016200
0.0650			1.650	43.00	20.00	9002060016500
0.0657			1.670	43.00	20.00	9002060016700
0.0669		51	1.700	43.00	20.00	9002060017000
0.0677			1.720	46.00	22.00	9002060017200
0.0681			1.730	46.00	22.00	9002060017300
0.0689			1.750	46.00	22.00	9002060017500
0.0701		50	1.780	46.00	22.00	9002060017800
0.0709			1.800	46.00	22.00	9002060018000
0.0728		49	1.850	46.00	22.00	9002060018500
0.0748			1.900	46.00	22.00	9002060019000
0.0756			1.920	49.00	24.00	9002060019200
0.0768			1.950	49.00	24.00	9002060019500
0.0780	5/64		1.980	49.00	24.00	9002060019800
0.0787			2.000	49.00	24.00	9002060020000
0.0795			2.020	49.00	24.00	9002060020200
0.0807			2.050	49.00	24.00	9002060020500
0.0811		46	2.060	49.00	24.00	9002060020600
0.0815			2.070	49.00	24.00	9002060020700
0.0827			2.100	49.00	24.00	9002060021000
0.0846			2.150	53.00	27.00	9002060021500
0.0858		44	2.180	53.00	27.00	9002060021800
0.0866			2.200	53.00	27.00	9002060022000
0.0886			2.250	53.00	27.00	9002060022500
0.0894			2.270	53.00	27.00	9002060022700
0.0906			2.300	53.00	27.00	9002060023000
0.0925			2.350	53.00	27.00	9002060023500
0.0937	3/32		2.380	57.00	30.00	9002060023800
0.0945			2.400	57.00	30.00	9002060024000
0.0965			2.450	57.00	30.00	9002060024500
0.0972			2.470	57.00	30.00	9002060024700
0.0984			2.500	57.00	30.00	9002060025000
0.0996		39	2.530	57.00	30.00	9002060025300
0.1004			2.550	57.00	30.00	9002060025500
0.1012			2.570	57.00	30.00	9002060025700
0.1024			2.600	57.00	30.00	9002060026000
0.1035			2.630	57.00	30.00	9002060026300
0.1039		37	2.640	57.00	30.00	9002060026400

Series 206

Speeds & Feeds information pg 424

Twist Drills

Dec. inch	Diameter (d1)		I1 mm	I2 mm	EDP #	
	Fract. inch	Wire / letter				
0.1043			2.650	57.00	30.00	9002060026500
0.1063			2.700	61.00	33.00	9002060027000
0.1067		36	2.710	61.00	33.00	9002060027100
0.1083			2.750	61.00	33.00	9002060027500
0.1094		7/64	2.780	61.00	33.00	9002060027800
0.1102			2.800	61.00	33.00	9002060028000
0.1110		34	2.820	61.00	33.00	9002060028200
0.1122			2.850	61.00	33.00	9002060028500
0.1142			2.900	61.00	33.00	9002060029000
0.1150			2.920	61.00	33.00	9002060029200
0.1161		32	2.950	61.00	33.00	9002060029500
0.1181			3.000	61.00	33.00	9002060030000
0.1201		31	3.050	65.00	36.00	9002060030500
0.1220			3.100	65.00	36.00	9002060031000
0.1240			3.150	65.00	36.00	9002060031500
0.1248		1/8	3.170	65.00	36.00	9002060031700
0.1260			3.200	65.00	36.00	9002060032000
0.1268			3.220	65.00	36.00	9002060032200
0.1280			3.250	65.00	36.00	9002060032500
0.1299			3.300	65.00	36.00	9002060033000
0.1319			3.350	65.00	36.00	9002060033500
0.1339			3.400	70.00	39.00	9002060034000
0.1358		29	3.450	70.00	39.00	9002060034500
0.1378			3.500	70.00	39.00	9002060035000
0.1398			3.550	70.00	39.00	9002060035500
0.1406		9/64	3.570	70.00	39.00	9002060035700
0.1417			3.600	70.00	39.00	9002060036000
0.1437			3.650	70.00	39.00	9002060036500
0.1457			3.700	70.00	39.00	9002060037000
0.1476			3.750	70.00	39.00	9002060037500
0.1496		25	3.800	75.00	43.00	9002060038000
0.1508			3.830	75.00	43.00	9002060038300
0.1516			3.850	75.00	43.00	9002060038500
0.1524			3.870	75.00	43.00	9002060038700
0.1535			3.900	75.00	43.00	9002060039000
0.1539		23	3.910	75.00	43.00	9002060039100
0.1555			3.950	75.00	43.00	9002060039500
0.1563		5/32	3.970	75.00	43.00	9002060039700
0.1575			4.000	75.00	43.00	9002060040000
0.1583			4.020	75.00	43.00	9002060040200
0.1591		21	4.040	75.00	43.00	9002060040400
0.1594			4.050	75.00	43.00	9002060040500
0.1614			4.100	75.00	43.00	9002060041000
0.1634			4.150	75.00	43.00	9002060041500
0.1654			4.200	75.00	43.00	9002060042000
0.1661		19	4.220	75.00	43.00	9002060042200
0.1673			4.250	75.00	43.00	9002060042500
0.1693		18	4.300	80.00	47.00	9002060043000
0.1720		11/64	4.370	80.00	47.00	9002060043700
0.1732			4.400	80.00	47.00	9002060044000
0.1752			4.450	80.00	47.00	9002060044500
0.1772		16	4.500	80.00	47.00	9002060045000
0.1811			4.600	80.00	47.00	9002060046000
0.1831			4.650	80.00	47.00	9002060046500
0.1850		13	4.700	80.00	47.00	9002060047000
0.1870			4.750	80.00	47.00	9002060047500
0.1874		3/16	4.760	86.00	52.00	9002060047600
0.1890		12	4.800	86.00	52.00	9002060048000
0.1909		11	4.850	86.00	52.00	9002060048500
0.1929			4.900	86.00	52.00	9002060049000
0.1949			4.950	86.00	52.00	9002060049500
0.1969			5.000	86.00	52.00	9002060050000
0.1988			5.050	86.00	52.00	9002060050500
0.2008			5.100	86.00	52.00	9002060051000
0.2031		13/64	5.160	86.00	52.00	9002060051600
0.2047			5.200	86.00	52.00	9002060052000
0.2067			5.250	86.00	52.00	9002060052500
0.2087			5.300	86.00	52.00	9002060053000
0.2091		4	5.310	93.00	57.00	9002060053100

Dec. inch	Diameter (d1)		I1 mm	I2 mm	EDP #	
	Fract. inch	Wire / letter				
0.2126			5.400	93.00	57.00	9002060054000
0.2165			5.500	93.00	57.00	9002060055000
0.2189		7/32	5.560	93.00	57.00	9002060055600
0.2205			5.600	93.00	57.00	9002060056000
0.2244			5.700	93.00	57.00	9002060057000
0.2264			5.750	93.00	57.00	9002060057500
0.2283			5.800	93.00	57.00	9002060058000
0.2323			5.900	93.00	57.00	9002060059000
0.2343		15/64	5.950	93.00	57.00	9002060059500
0.2362			6.000	93.00	57.00	9002060060000
0.2382			6.050	101.00	63.00	9002060060500
0.2402			6.100	101.00	63.00	9002060061000
0.2421		C	6.150	101.00	63.00	9002060061500
0.2441			6.200	101.00	63.00	9002060062000
0.2461		D	6.250	101.00	63.00	9002060062500
0.2480			6.300	101.00	63.00	9002060063000
0.2500		1/4	6.350	101.00	63.00	9002060063500
0.2520			6.400	101.00	63.00	9002060064000
0.2539			6.450	101.00	63.00	9002060064500
0.2559			6.500	101.00	63.00	9002060065000
0.2571		F	6.530	101.00	63.00	9002060065300
0.2579			6.550	101.00	63.00	9002060065500
0.2598			6.600	101.00	63.00	9002060066000
0.2638			6.700	101.00	63.00	9002060067000
0.2657		17/64	6.750	109.00	69.00	9002060067500
0.2677			6.800	109.00	69.00	9002060068000
0.2717		I	6.900	109.00	69.00	9002060069000
0.2756			7.000	109.00	69.00	9002060070000
0.2795			7.100	109.00	69.00	9002060071000
0.2811		9/32	7.140	109.00	69.00	9002060071400
0.2835			7.200	109.00	69.00	9002060072000
0.2854			7.250	109.00	69.00	9002060072500
0.2874			7.300	109.00	69.00	9002060073000
0.2894			7.350	109.00	69.00	9002060073500
0.2913			7.400	109.00	69.00	9002060074000
0.2953			7.500	109.00	69.00	9002060075000
0.2969		19/64	7.540	117.00	75.00	9002060075400
0.2992			7.600	117.00	75.00	9002060076000
0.3031			7.700	117.00	75.00	9002060077000
0.3051			7.750	117.00	75.00	9002060077500
0.3071			7.800	117.00	75.00	9002060078000
0.3110			7.900	117.00	75.00	9002060079000
0.3126		5/16	7.940	117.00	75.00	9002060079400
0.3150			8.000	117.00	75.00	9002060080000
0.3169			8.050	117.00	75.00	9002060080500
0.3189			8.100	117.00	75.00	9002060081000
0.3228		P	8.200	117.00	75.00	9002060082000
0.3248			8.250	117.00	75.00	9002060082500
0.3268			8.300	117.00	75.00	9002060083000
0.3280		21/64	8.330	117.00	75.00	9002060083300
0.3307			8.400	117.00	75.00	9002060084000
0.3319		Q	8.430	117.00	75.00	9002060084300
0.3346			8.500	117.00	75.00	9002060085000
0.3386			8.600	125.00	81.00	9002060086000
0.3425			8.700	125.00	81.00	9002060087000
0.3437		11/32	8.730	125.00	81.00	9002060087300
0.3465			8.800	125.00	81.00	9002060088000
0.3504			8.900	125.00	81.00	9002060089000
0.3543			9.000	125.00	81.00	9002060090000
0.3583			9.100	125.00	81.00	9002060091000
0.3594		23/64	9.130	125.00	81.00	9002060091300
0.3622			9.200	125.00	81.00	9002060092000
0.3642			9.250	125.00	81.00	9002060092500
0.3661			9.300	125.00	81.00	9002060093000
0.3701			9.400	125.00	81.00	9002060094000
0.3740			9.500	125.00	81.00	9002060095000
0.3748		3/8	9.520	133.00	87.00	9002060095200
0.3780			9.600	133.00	87.00	9002060096000
0.3819			9.700	133.00	87.00	9002060097000

*Items listed in red are non-stocked items, and may take 2 - 6 weeks to receive

Series 206

Speeds & Feeds information pg 424

Dec. inch	Diameter (d1)		I1 mm	I2 mm	EDP #	
	Fract. inch	Wire / letter				
0.3839			9.750	133.00	87.00	9002060097500
0.3858		W	9.800	133.00	87.00	9002060098000
0.3898			9.900	133.00	87.00	9002060099000
0.3906	25/64		9.920	133.00	87.00	9002060099200
0.3937			10.000	133.00	87.00	9002060100000
0.3976			10.100	133.00	87.00	9002060101000
0.4016			10.200	133.00	87.00	9002060102000
0.4035			10.250	133.00	87.00	9002060102500
0.4055			10.300	133.00	87.00	9002060103000
0.4063	13/32		10.320	133.00	87.00	9002060103200
0.4134			10.500	133.00	87.00	9002060105000
0.4173			10.600	133.00	87.00	9002060106000
0.4220	27/64		10.720	142.00	94.00	9002060107200
0.4252			10.800	142.00	94.00	9002060108000
0.4291			10.900	142.00	94.00	9002060109000
0.4331			11.000	142.00	94.00	9002060110000
0.4370			11.100	142.00	94.00	9002060111000
0.4374	7/16		11.110	142.00	94.00	9002060111100
0.4409			11.200	142.00	94.00	9002060112000
0.4449			11.300	142.00	94.00	9002060113000
0.4488			11.400	142.00	94.00	9002060114000
0.4528			11.500	142.00	94.00	9002060115000
0.4531	29/64		11.510	142.00	94.00	9002060115100
0.4567			11.600	142.00	94.00	9002060116000
0.4606			11.700	142.00	94.00	9002060117000

Dec. inch	Diameter (d1)		I1 mm	I2 mm	EDP #	
	Fract. inch	Wire / letter				
0.4646			11.800	142.00	94.00	9002060118000
0.4685			11.900	151.00	101.00	9002060119000
0.4689	15/32		11.910	151.00	101.00	9002060119100
0.4724			12.000	151.00	101.00	9002060120000
0.4764			12.100	151.00	101.00	9002060121000
0.4803			12.200	151.00	101.00	9002060122000
0.4843	31/64		12.300	151.00	101.00	9002060123000
0.4921			12.500	151.00	101.00	9002060125000
0.5000	1/2		12.700	151.00	101.00	9002060127000
0.5039			12.800	151.00	101.00	9002060128000
0.5118			13.000	151.00	101.00	9002060130000
0.5197			13.200	151.00	101.00	9002060132000
0.5315			13.500	160.00	108.00	9002060135000
0.5512			14.000	160.00	108.00	9002060140000
0.5709			14.500	169.00	114.00	9002060145000
0.5906			15.000	169.00	114.00	9002060150000
0.6299			16.000	178.00	120.00	9002060160000
0.6693			17.000	184.00	125.00	9002060170000
0.7087			18.000	191.00	130.00	9002060180000
0.7480			19.000	198.00	135.00	9002060190000
0.7874			20.000	205.00	140.00	9002060200000

Alternative Drill Series:

#205 HSS, GP, 5xD, 118 pt, Oxide

5xD

Series 207

Application Materials:

-  General Steels/Brass
-  Aluminum & Alloys

Twist Drills

High Helix

HSS, High Helix (Type W), jobber length, 130° point, Form A web thinned >14.0mm dia., standard straight shank, RH helix

Cut / Shank Dia. = h8 tolerance range

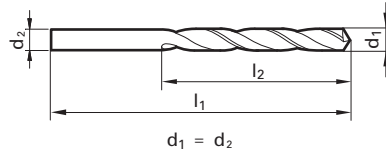

Speeds & Feeds information pg 425

Dec. inch	Diameter (d1)		l1 mm	l2 mm	EDP #	
	Fract. inch	Wire / letter mm				
0.0079		92	0.200	19.00	2.50	9002070002000
0.0118			0.300	19.00	3.00	9002070003000
0.0138			0.350	19.00	4.00	9002070003500
0.0157	1/64		0.400	20.00	5.00	9002070004000
0.0177			0.450	20.00	5.00	9002070004500
0.0181		77	0.460	20.00	5.00	9002070004600
0.0197			0.500	22.00	6.00	9002070005000
0.0201		76	0.510	22.00	6.00	9002070005100
0.0217			0.550	24.00	7.00	9002070005500
0.0224		74	0.570	24.00	7.00	9002070005700
0.0236			0.600	24.00	7.00	9002070006000
0.0240		73	0.610	26.00	8.00	9002070006100
0.0244			0.620	26.00	8.00	9002070006200
0.0252		72	0.640	26.00	8.00	9002070006400
0.0256			0.650	26.00	8.00	9002070006500
0.0260		71	0.660	26.00	8.00	9002070006600
0.0276			0.700	28.00	9.00	9002070007000
0.0295			0.750	28.00	9.00	9002070007500
0.0307			0.780	30.00	10.00	9002070007800
0.0311	1/32	68	0.790	30.00	10.00	9002070007900
0.0315			0.800	30.00	10.00	9002070008000
0.0319		67	0.810	30.00	10.00	9002070008100
0.0331		66	0.840	30.00	10.00	9002070008400
0.0335			0.850	30.00	10.00	9002070008500
0.0339			0.860	32.00	11.00	9002070008600
0.0343			0.870	32.00	11.00	9002070008700
0.0354			0.900	32.00	11.00	9002070009000
0.0374			0.950	32.00	11.00	9002070009500
0.0382		62	0.970	34.00	12.00	9002070009700
0.0386			0.980	34.00	12.00	9002070009800
0.0390		61	0.990	34.00	12.00	9002070009900
0.0394			1.000	34.00	12.00	9002070010000
0.0398			1.010	34.00	12.00	9002070010100
0.0402		60	1.020	34.00	12.00	9002070010200
0.0413			1.050	34.00	12.00	9002070010500
0.0421		58	1.070	36.00	14.00	9002070010700
0.0425			1.080	36.00	14.00	9002070010800
0.0433			1.100	36.00	14.00	9002070011000
0.0441			1.120	36.00	14.00	9002070011200
0.0453			1.150	36.00	14.00	9002070011500
0.0465		56	1.180	36.00	14.00	9002070011800
0.0469	3/64		1.190	38.00	16.00	9002070011900
0.0472			1.200	38.00	16.00	9002070012000
0.0480			1.220	38.00	16.00	9002070012200
0.0492			1.250	38.00	16.00	9002070012500
0.0500			1.270	38.00	16.00	9002070012700
0.0512			1.300	38.00	16.00	9002070013000
0.0516			1.310	38.00	16.00	9002070013100
0.0524			1.330	40.00	18.00	9002070013300
0.0531			1.350	40.00	18.00	9002070013500
0.0543			1.380	40.00	18.00	9002070013800
0.0551		54	1.400	40.00	18.00	9002070014000
0.0559			1.420	40.00	18.00	9002070014200
0.0563			1.430	40.00	18.00	9002070014300

Dec. inch	Diameter (d1)		l1 mm	l2 mm	EDP #	
	Fract. inch	Wire / letter mm				
0.0571			1.450	40.00	18.00	9002070014500
0.0579			1.470	40.00	18.00	9002070014700
0.0591			1.500	40.00	18.00	9002070015000
0.0594		53	1.510	43.00	20.00	9002070015100
0.0610			1.550	43.00	20.00	9002070015500
0.0622			1.580	43.00	20.00	9002070015800
0.0626		1/16	1.590	43.00	20.00	9002070015900
0.0630			1.600	43.00	20.00	9002070016000
0.0634		52	1.610	43.00	20.00	9002070016100
0.0650			1.650	43.00	20.00	9002070016500
0.0669		51	1.700	43.00	20.00	9002070017000
0.0689			1.750	46.00	22.00	9002070017500
0.0693			1.760	46.00	22.00	9002070017600
0.0697			1.770	46.00	22.00	9002070017700
0.0701		50	1.780	46.00	22.00	9002070017800
0.0709			1.800	46.00	22.00	9002070018000
0.0728		49	1.850	46.00	22.00	9002070018500
0.0748			1.900	46.00	22.00	9002070019000
0.0760		48	1.930	49.00	24.00	9002070019300
0.0768			1.950	49.00	24.00	9002070019500
0.0780		5/64	1.980	49.00	24.00	9002070019800
0.0787			2.000	49.00	24.00	9002070020000
0.0795			2.020	49.00	24.00	9002070020200
0.0807			2.050	49.00	24.00	9002070020500
0.0811		46	2.060	49.00	24.00	9002070020600
0.0819		45	2.080	49.00	24.00	9002070020800
0.0827			2.100	49.00	24.00	9002070021000
0.0846			2.150	53.00	27.00	9002070021500
0.0866			2.200	53.00	27.00	9002070022000
0.0874			2.220	53.00	27.00	9002070022200
0.0886			2.250	53.00	27.00	9002070022500
0.0906			2.300	53.00	27.00	9002070023000
0.0913			2.320	53.00	27.00	9002070023200
0.0925			2.350	53.00	27.00	9002070023500
0.0937		3/32	2.380	57.00	30.00	9002070023800
0.0945			2.400	57.00	30.00	9002070024000
0.0965			2.450	57.00	30.00	9002070024500
0.0980		40	2.490	57.00	30.00	9002070024900
0.0984			2.500	57.00	30.00	9002070025000
0.0996		39	2.530	57.00	30.00	9002070025300
0.1004			2.550	57.00	30.00	9002070025500
0.1016		38	2.580	57.00	30.00	9002070025800
0.1024			2.600	57.00	30.00	9002070026000
0.1043			2.650	57.00	30.00	9002070026500
0.1063			2.700	61.00	33.00	9002070027000
0.1071			2.720	61.00	33.00	9002070027200
0.1075			2.730	61.00	33.00	9002070027300
0.1083			2.750	61.00	33.00	9002070027500
0.1094		7/64	2.780	61.00	33.00	9002070027800
0.1102			2.800	61.00	33.00	9002070028000
0.1110		34	2.820	61.00	33.00	9002070028200
0.1122			2.850	61.00	33.00	9002070028500
0.1142			2.900	61.00	33.00	9002070029000
0.1161		32	2.950	61.00	33.00	9002070029500

*Items listed in red are non-stocked items, and may take 2 - 6 weeks to receive

Series 207

Speeds & Feeds information pg 425

Twist Drills

Dec. inch	Diameter (d1)		I1 mm	I2 mm	EDP #	
	Fract. inch	Wire / letter				
0.1181			3.000	61.00	33.00	9002070030000
0.1193			3.030	65.00	36.00	9002070030300
0.1201		31	3.050	65.00	36.00	9002070030500
0.1205			3.060	65.00	36.00	9002070030600
0.1220			3.100	65.00	36.00	9002070031000
0.1240			3.150	65.00	36.00	9002070031500
0.1248		1/8	3.170	65.00	36.00	9002070031700
0.1260			3.200	65.00	36.00	9002070032000
0.1280			3.250	65.00	36.00	9002070032500
0.1283		30	3.260	65.00	36.00	9002070032600
0.1299			3.300	65.00	36.00	9002070033000
0.1319			3.350	65.00	36.00	9002070033500
0.1339			3.400	70.00	39.00	9002070034000
0.1358		29	3.450	70.00	39.00	9002070034500
0.1378			3.500	70.00	39.00	9002070035000
0.1390			3.530	70.00	39.00	9002070035300
0.1398			3.550	70.00	39.00	9002070035500
0.1406		9/64	3.570	70.00	39.00	9002070035700
0.1417			3.600	70.00	39.00	9002070036000
0.1437			3.650	70.00	39.00	9002070036500
0.1457			3.700	70.00	39.00	9002070037000
0.1469		26	3.730	70.00	39.00	9002070037300
0.1476			3.750	70.00	39.00	9002070037500
0.1496		25	3.800	75.00	43.00	9002070038000
0.1516			3.850	75.00	43.00	9002070038500
0.1535			3.900	75.00	43.00	9002070039000
0.1555			3.950	75.00	43.00	9002070039500
0.1563		5/32	3.970	75.00	43.00	9002070039700
0.1575			4.000	75.00	43.00	9002070040000
0.1591		21	4.040	75.00	43.00	9002070040400
0.1594			4.050	75.00	43.00	9002070040500
0.1614			4.100	75.00	43.00	9002070041000
0.1634			4.150	75.00	43.00	9002070041500
0.1654			4.200	75.00	43.00	9002070042000
0.1661		19	4.220	75.00	43.00	9002070042200
0.1673			4.250	75.00	43.00	9002070042500
0.1693		18	4.300	80.00	47.00	9002070043000
0.1713			4.350	80.00	47.00	9002070043500
0.1732			4.400	80.00	47.00	9002070044000
0.1772		16	4.500	80.00	47.00	9002070045000
0.1811			4.600	80.00	47.00	9002070046000
0.1831			4.650	80.00	47.00	9002070046500
0.1850		13	4.700	80.00	47.00	9002070047000
0.1870			4.750	80.00	47.00	9002070047500
0.1874		3/16	4.760	86.00	52.00	9002070047600
0.1890		12	4.800	86.00	52.00	9002070048000
0.1909		11	4.850	86.00	52.00	9002070048500
0.1929			4.900	86.00	52.00	9002070049000
0.1949			4.950	86.00	52.00	9002070049500
0.1969			5.000	86.00	52.00	9002070050000
0.1988			5.050	86.00	52.00	9002070050500
0.2008			5.100	86.00	52.00	9002070051000
0.2031		13/64	5.160	86.00	52.00	9002070051600
0.2047			5.200	86.00	52.00	9002070052000
0.2067			5.250	86.00	52.00	9002070052500
0.2087			5.300	86.00	52.00	9002070053000
0.2126			5.400	93.00	57.00	9002070054000
0.2146			5.450	93.00	57.00	9002070054500
0.2165			5.500	93.00	57.00	9002070055000
0.2189		7/32	5.560	93.00	57.00	9002070055600
0.2205			5.600	93.00	57.00	9002070056000
0.2244			5.700	93.00	57.00	9002070057000
0.2264			5.750	93.00	57.00	9002070057500
0.2283			5.800	93.00	57.00	9002070058000
0.2303			5.850	93.00	57.00	9002070058500
0.2323			5.900	93.00	57.00	9002070059000
0.2343		15/64	5.950	93.00	57.00	9002070059500
0.2362			6.000	93.00	57.00	9002070060000
0.2402			6.100	101.00	63.00	9002070061000
0.2421		C	6.150	101.00	63.00	9002070061500

Dec. inch	Diameter (d1)		I1 mm	I2 mm	EDP #	
	Fract. inch	Wire / letter				
0.2441			6.200	101.00	63.00	9002070062000
0.2461		D	6.250	101.00	63.00	9002070062500
0.2480			6.300	101.00	63.00	9002070063000
0.2500		1/4	6.350	101.00	63.00	9002070063500
0.2520			6.400	101.00	63.00	9002070064000
0.2559			6.500	101.00	63.00	9002070065000
0.2571		F	6.530	101.00	63.00	9002070065300
0.2598			6.600	101.00	63.00	9002070066000
0.2618			6.650	101.00	63.00	9002070066500
0.2638			6.700	101.00	63.00	9002070067000
0.2657		17/64	6.750	109.00	69.00	9002070067500
0.2677			6.800	109.00	69.00	9002070068000
0.2697			6.850	109.00	69.00	9002070068500
0.2717		I	6.900	109.00	69.00	9002070069000
0.2736			6.950	109.00	69.00	9002070069500
0.2756			7.000	109.00	69.00	9002070070000
0.2776			7.050	109.00	69.00	9002070070500
0.2795			7.100	109.00	69.00	9002070071000
0.2811		9/32	7.140	109.00	69.00	9002070071400
0.2835			7.200	109.00	69.00	9002070072000
0.2854			7.250	109.00	69.00	9002070072500
0.2874			7.300	109.00	69.00	9002070073000
0.2913			7.400	109.00	69.00	9002070074000
0.2953			7.500	109.00	69.00	9002070075000
0.2969		19/64	7.540	117.00	75.00	9002070075400
0.2992			7.600	117.00	75.00	9002070076000
0.3031			7.700	117.00	75.00	9002070077000
0.3051			7.750	117.00	75.00	9002070077500
0.3071			7.800	117.00	75.00	9002070078000
0.3110			7.900	117.00	75.00	9002070079000
0.3126		5/16	7.940	117.00	75.00	9002070079400
0.3150			8.000	117.00	75.00	9002070080000
0.3161		O	8.030	117.00	75.00	9002070080300
0.3189			8.100	117.00	75.00	9002070081000
0.3209			8.150	117.00	75.00	9002070081500
0.3228		P	8.200	117.00	75.00	9002070082000
0.3248			8.250	117.00	75.00	9002070082500
0.3268			8.300	117.00	75.00	9002070083000
0.3307			8.400	117.00	75.00	9002070084000
0.3346			8.500	117.00	75.00	9002070085000
0.3386			8.600	125.00	81.00	9002070086000
0.3425			8.700	125.00	81.00	9002070087000
0.3437		11/32	8.730	125.00	81.00	9002070087300
0.3445			8.750	125.00	81.00	9002070087500
0.3465			8.800	125.00	81.00	9002070088000
0.3480		S	8.840	125.00	81.00	9002070088400
0.3504			8.900	125.00	81.00	9002070089000
0.3543			9.000	125.00	81.00	9002070090000
0.3579		T	9.090	125.00	81.00	9002070090900
0.3583			9.100	125.00	81.00	9002070091000
0.3594		23/64	9.130	125.00	81.00	9002070091300
0.3622			9.200	125.00	81.00	9002070092000
0.3661			9.300	125.00	81.00	9002070093000
0.3677		U	9.340	125.00	81.00	9002070093400
0.3701			9.400	125.00	81.00	9002070094000
0.3740			9.500	125.00	81.00	9002070095000
0.3748		3/8	9.520	133.00	87.00	9002070095200
0.3780			9.600	133.00	87.00	9002070096000
0.3819			9.700	133.00	87.00	9002070097000
0.3858		W	9.800	133.00	87.00	9002070098000
0.3898			9.900	133.00	87.00	9002070099000
0.3906		25/64	9.920	133.00	87.00	9002070099200
0.3937			10.000	133.00	87.00	9002070100000
0.3969		X	10.080	133.00	87.00	9002070100800
0.3976			10.100	133.00	87.00	9002070101000
0.4016			10.200	133.00	87.00	9002070102000
0.4035			10.250	133.00	87.00	9002070102500
0.4039		Y	10.260	133.00	87.00	9002070102600
0.4055			10.300	133.00	87.00	9002070103000
0.4063		13/32	10.320	133.00	87.00	9002070103200

Series 207

Speeds & Feeds information pg 425

Twist Drills

Dec. inch	Diameter (d1)		I1 mm	I2 mm	EDP #	
	Fract. inch	Wire / letter				
0.4094			10.400	133.00	87.00	9002070104000
0.4134			10.500	133.00	87.00	9002070105000
0.4173			10.600	133.00	87.00	9002070106000
0.4213			10.700	142.00	94.00	9002070107000
0.4232			10.750	142.00	94.00	9002070107500
0.4252			10.800	142.00	94.00	9002070108000
0.4291			10.900	142.00	94.00	9002070109000
0.4331			11.000	142.00	94.00	9002070110000
0.4370			11.100	142.00	94.00	9002070111000
0.4374	7/16		11.110	142.00	94.00	9002070111100
0.4409			11.200	142.00	94.00	9002070112000
0.4429			11.250	142.00	94.00	9002070112500
0.4449			11.300	142.00	94.00	9002070113000
0.4488			11.400	142.00	94.00	9002070114000
0.4528			11.500	142.00	94.00	9002070115000
0.4531	29/64		11.510	142.00	94.00	9002070115100
0.4567			11.600	142.00	94.00	9002070116000
0.4606			11.700	142.00	94.00	9002070117000
0.4626			11.750	142.00	94.00	9002070117500
0.4646			11.800	142.00	94.00	9002070118000
0.4685			11.900	151.00	101.00	9002070119000
0.4724			12.000	151.00	101.00	9002070120000
0.4764			12.100	151.00	101.00	9002070121000
0.4843	31/64		12.300	151.00	101.00	9002070123000
0.4921			12.500	151.00	101.00	9002070125000
0.4961			12.600	151.00	101.00	9002070126000
0.5000	1/2		12.700	151.00	101.00	9002070127000

Dec. inch	Diameter (d1)		I1 mm	I2 mm	EDP #	
	Fract. inch	Wire / letter				
0.5039			12.800	151.00	101.00	9002070128000
0.5079			12.900	151.00	101.00	9002070129000
0.5118			13.000	151.00	101.00	9002070130000
0.5157	33/64		13.100	151.00	101.00	9002070131000
0.5197			13.200	151.00	101.00	9002070132000
0.5315			13.500	160.00	108.00	9002070135000
0.5433			13.800	160.00	108.00	9002070138000
0.5512			14.000	160.00	108.00	9002070140000
0.5709			14.500	169.00	114.00	9002070145000
0.5787			14.700	169.00	114.00	9002070147000
0.5827			14.800	169.00	114.00	9002070148000
0.5906			15.000	169.00	114.00	9002070150000
0.5984			15.200	178.00	120.00	9002070152000
0.6102			15.500	178.00	120.00	9002070155000
0.6299			16.000	178.00	120.00	9002070160000
0.6496			16.500	184.00	125.00	9002070165000
0.6693			17.000	184.00	125.00	9002070170000
0.7087			18.000	191.00	130.00	9002070180000
0.7185			18.250	198.00	135.00	9002070182500
0.7480			19.000	198.00	135.00	9002070190000
0.7874			20.000	205.00	140.00	9002070200000

Alternative Drill Series:
#549 HSS, GT100, 5xD, 130 pt, bright/nitrided lands > 2.36

*Items listed in red are non-stocked items, and may take 2 - 6 weeks to receive

5xD

Series 208

Application Materials:



-  General Steels/Brass
-  Universal Steels
-  Cast Iron

General Purpose, LH helix

HSS, general purpose (Type N), jobber length, 118° point, Form A web thinned >14.0mm dia., standard straight shank, LH cut

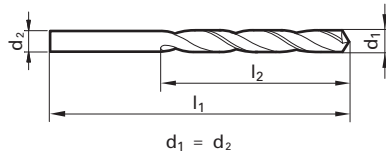
Cut / Shank Dia. = h8 tolerance range



-  Steam Oxide >6.00 mm dia.
-  External Coolant

-  Straight Shank

Speeds & Feeds information pg 425

Diameter (d1)		Wire / letter	mm	l1 mm	l2 mm	EDP #
Dec. inch	Fract. inch					
0.0094		88	0.240	19.00	2.50	9002080002400
0.0114		84	0.290	19.00	3.00	9002080002900
0.0118			0.300	19.00	3.00	9002080003000
0.0134		80	0.340	19.00	4.00	9002080003400
0.0138			0.350	19.00	4.00	9002080003500
0.0142			0.360	19.00	4.00	9002080003600
0.0146		79	0.370	19.00	4.00	9002080003700
0.0157	1/64		0.400	20.00	5.00	9002080004000
0.0161		78	0.410	20.00	5.00	9002080004100
0.0165			0.420	20.00	5.00	9002080004200
0.0169			0.430	20.00	5.00	9002080004300
0.0173			0.440	20.00	5.00	9002080004400
0.0177			0.450	20.00	5.00	9002080004500
0.0181		77	0.460	20.00	5.00	9002080004600
0.0185			0.470	20.00	5.00	9002080004700
0.0189			0.480	20.00	5.00	9002080004800
0.0197			0.500	22.00	6.00	9002080005000
0.0201		76	0.510	22.00	6.00	9002080005100
0.0205			0.520	22.00	6.00	9002080005200
0.0209		75	0.530	22.00	6.00	9002080005300
0.0213			0.540	24.00	7.00	9002080005400
0.0217			0.550	24.00	7.00	9002080005500
0.0220			0.560	24.00	7.00	9002080005600
0.0224		74	0.570	24.00	7.00	9002080005700
0.0228			0.580	24.00	7.00	9002080005800
0.0236			0.600	24.00	7.00	9002080006000
0.0240		73	0.610	26.00	8.00	9002080006100
0.0244			0.620	26.00	8.00	9002080006200
0.0248			0.630	26.00	8.00	9002080006300
0.0252		72	0.640	26.00	8.00	9002080006400
0.0256			0.650	26.00	8.00	9002080006500
0.0260		71	0.660	26.00	8.00	9002080006600
0.0264			0.670	26.00	8.00	9002080006700
0.0268			0.680	28.00	9.00	9002080006800
0.0276			0.700	28.00	9.00	9002080007000
0.0280		70	0.710	28.00	9.00	9002080007100
0.0283			0.720	28.00	9.00	9002080007200
0.0287			0.730	28.00	9.00	9002080007300
0.0295			0.750	28.00	9.00	9002080007500
0.0303			0.770	30.00	10.00	9002080007700
0.0307			0.780	30.00	10.00	9002080007800
0.0311	1/32	68	0.790	30.00	10.00	9002080007900
0.0315			0.800	30.00	10.00	9002080008000
0.0319		67	0.810	30.00	10.00	9002080008100
0.0323			0.820	30.00	10.00	9002080008200
0.0327			0.830	30.00	10.00	9002080008300
0.0331		66	0.840	30.00	10.00	9002080008400
0.0335			0.850	30.00	10.00	9002080008500
0.0339			0.860	32.00	11.00	9002080008600
0.0343			0.870	32.00	11.00	9002080008700
0.0346			0.880	32.00	11.00	9002080008800
0.0350		65	0.890	32.00	11.00	9002080008900
0.0354			0.900	32.00	11.00	9002080009000
0.0358		64	0.910	32.00	11.00	9002080009100

Diameter (d1)		Wire / letter	mm	l1 mm	l2 mm	EDP #
Dec. inch	Fract. inch					
0.0362			0.920	32.00	11.00	9002080009200
0.0366			0.930	32.00	11.00	9002080009300
0.0374			0.950	32.00	11.00	9002080009500
0.0378			0.960	34.00	12.00	9002080009600
0.0382		62	0.970	34.00	12.00	9002080009700
0.0386			0.980	34.00	12.00	9002080009800
0.0390		61	0.990	34.00	12.00	9002080009900
0.0394			1.000	34.00	12.00	9002080010000
0.0402		60	1.020	34.00	12.00	9002080010200
0.0409		59	1.040	34.00	12.00	9002080010400
0.0413			1.050	34.00	12.00	9002080010500
0.0421		58	1.070	36.00	14.00	9002080010700
0.0425			1.080	36.00	14.00	9002080010800
0.0429		57	1.090	36.00	14.00	9002080010900
0.0433			1.100	36.00	14.00	9002080011000
0.0441			1.120	36.00	14.00	9002080011200
0.0445			1.130	36.00	14.00	9002080011300
0.0453			1.150	36.00	14.00	9002080011500
0.0461			1.170	36.00	14.00	9002080011700
0.0465		56	1.180	36.00	14.00	9002080011800
0.0469	3/64		1.190	38.00	16.00	9002080011900
0.0472			1.200	38.00	16.00	9002080012000
0.0476			1.210	38.00	16.00	9002080012100
0.0480			1.220	38.00	16.00	9002080012200
0.0488			1.240	38.00	16.00	9002080012400
0.0492			1.250	38.00	16.00	9002080012500
0.0500			1.270	38.00	16.00	9002080012700
0.0512			1.300	38.00	16.00	9002080013000
0.0520		55	1.320	38.00	16.00	9002080013200
0.0531			1.350	40.00	18.00	9002080013500
0.0543			1.380	40.00	18.00	9002080013800
0.0547			1.390	40.00	18.00	9002080013900
0.0551		54	1.400	40.00	18.00	9002080014000
0.0559			1.420	40.00	18.00	9002080014200
0.0571			1.450	40.00	18.00	9002080014500
0.0579			1.470	40.00	18.00	9002080014700
0.0591			1.500	40.00	18.00	9002080015000
0.0594		53	1.510	43.00	20.00	9002080015100
0.0602			1.530	43.00	20.00	9002080015300
0.0610			1.550	43.00	20.00	9002080015500
0.0614			1.560	43.00	20.00	9002080015600
0.0626	1/16		1.590	43.00	20.00	9002080015900
0.0630			1.600	43.00	20.00	9002080016000
0.0634		52	1.610	43.00	20.00	9002080016100
0.0638			1.620	43.00	20.00	9002080016200
0.0642			1.630	43.00	20.00	9002080016300
0.0650			1.650	43.00	20.00	9002080016500
0.0654			1.660	43.00	20.00	9002080016600
0.0661			1.680	43.00	20.00	9002080016800
0.0669		51	1.700	43.00	20.00	9002080017000
0.0677			1.720	46.00	22.00	9002080017200
0.0681			1.730	46.00	22.00	9002080017300
0.0689			1.750	46.00	22.00	9002080017500
0.0693			1.760	46.00	22.00	9002080017600

Series 208

Speeds & Feeds information pg 425

Twist Drills

Diameter (d1)		Wire / letter	mm	l1 mm	l2 mm	EDP #
Dec. inch	Fract. inch					
0.0709			1.800	46.00	22.00	9002080018000
0.0717			1.820	46.00	22.00	9002080018200
0.0720			1.830	46.00	22.00	9002080018300
0.0724			1.840	46.00	22.00	9002080018400
0.0728		49	1.850	46.00	22.00	9002080018500
0.0748			1.900	46.00	22.00	9002080019000
0.0760		48	1.930	49.00	24.00	9002080019300
0.0764			1.940	49.00	24.00	9002080019400
0.0768			1.950	49.00	24.00	9002080019500
0.0776			1.970	49.00	24.00	9002080019700
0.0780	5/64		1.980	49.00	24.00	9002080019800
0.0787			2.000	49.00	24.00	9002080020000
0.0803			2.040	49.00	24.00	9002080020400
0.0807			2.050	49.00	24.00	9002080020500
0.0811		46	2.060	49.00	24.00	9002080020600
0.0819		45	2.080	49.00	24.00	9002080020800
0.0827			2.100	49.00	24.00	9002080021000
0.0835			2.120	49.00	24.00	9002080021200
0.0846			2.150	53.00	27.00	9002080021500
0.0858		44	2.180	53.00	27.00	9002080021800
0.0866			2.200	53.00	27.00	9002080022000
0.0886			2.250	53.00	27.00	9002080022500
0.0890		43	2.260	53.00	27.00	9002080022600
0.0898			2.280	53.00	27.00	9002080022800
0.0906			2.300	53.00	27.00	9002080023000
0.0913			2.320	53.00	27.00	9002080023200
0.0925			2.350	53.00	27.00	9002080023500
0.0933		42	2.370	57.00	30.00	9002080023700
0.0937	3/32		2.380	57.00	30.00	9002080023800
0.0945			2.400	57.00	30.00	9002080024000
0.0961		41	2.440	57.00	30.00	9002080024400
0.0965			2.450	57.00	30.00	9002080024500
0.0980		40	2.490	57.00	30.00	9002080024900
0.0984			2.500	57.00	30.00	9002080025000
0.0996		39	2.530	57.00	30.00	9002080025300
0.1004			2.550	57.00	30.00	9002080025500
0.1016		38	2.580	57.00	30.00	9002080025800
0.1024			2.600	57.00	30.00	9002080026000
0.1039		37	2.640	57.00	30.00	9002080026400
0.1043			2.650	57.00	30.00	9002080026500
0.1063			2.700	61.00	33.00	9002080027000
0.1075			2.730	61.00	33.00	9002080027300
0.1083			2.750	61.00	33.00	9002080027500
0.1094	7/64		2.780	61.00	33.00	9002080027800
0.1102			2.800	61.00	33.00	9002080028000
0.1110		34	2.820	61.00	33.00	9002080028200
0.1122			2.850	61.00	33.00	9002080028500
0.1130		33	2.870	61.00	33.00	9002080028700
0.1142			2.900	61.00	33.00	9002080029000
0.1161		32	2.950	61.00	33.00	9002080029500
0.1169			2.970	61.00	33.00	9002080029700
0.1181			3.000	61.00	33.00	9002080030000
0.1201		31	3.050	65.00	36.00	9002080030500
0.1209			3.070	65.00	36.00	9002080030700
0.1220			3.100	65.00	36.00	9002080031000
0.1240			3.150	65.00	36.00	9002080031500
0.1248	1/8		3.170	65.00	36.00	9002080031700
0.1260			3.200	65.00	36.00	9002080032000
0.1268			3.220	65.00	36.00	9002080032200
0.1280			3.250	65.00	36.00	9002080032500
0.1283		30	3.260	65.00	36.00	9002080032600
0.1299			3.300	65.00	36.00	9002080033000
0.1319			3.350	65.00	36.00	9002080033500
0.1327			3.370	70.00	39.00	9002080033700
0.1339			3.400	70.00	39.00	9002080034000
0.1358		29	3.450	70.00	39.00	9002080034500
0.1378			3.500	70.00	39.00	9002080035000
0.1398			3.550	70.00	39.00	9002080035500
0.1406	9/64	28	3.570	70.00	39.00	9002080035700
0.1417			3.600	70.00	39.00	9002080036000
0.1437			3.650	70.00	39.00	9002080036500

Diameter (d1)		Wire / letter	mm	l1 mm	l2 mm	EDP #
Dec. inch	Fract. inch					
0.1457			3.700	70.00	39.00	9002080037000
0.1476			3.750	70.00	39.00	9002080037500
0.1496		25	3.800	75.00	43.00	9002080038000
0.1516			3.850	75.00	43.00	9002080038500
0.1535			3.900	75.00	43.00	9002080039000
0.1539		23	3.910	75.00	43.00	9002080039100
0.1555			3.950	75.00	43.00	9002080039500
0.1563	5/32		3.970	75.00	43.00	9002080039700
0.1575			4.000	75.00	43.00	9002080040000
0.1594			4.050	75.00	43.00	9002080040500
0.1614			4.100	75.00	43.00	9002080041000
0.1626			4.130	75.00	43.00	9002080041300
0.1634			4.150	75.00	43.00	9002080041500
0.1654			4.200	75.00	43.00	9002080042000
0.1673			4.250	75.00	43.00	9002080042500
0.1693		18	4.300	80.00	47.00	9002080043000
0.1713			4.350	80.00	47.00	9002080043500
0.1720	11/64		4.370	80.00	47.00	9002080043700
0.1728		17	4.390	80.00	47.00	9002080043900
0.1732			4.400	80.00	47.00	9002080044000
0.1752			4.450	80.00	47.00	9002080044500
0.1772		16	4.500	80.00	47.00	9002080045000
0.1791			4.550	80.00	47.00	9002080045500
0.1799		15	4.570	80.00	47.00	9002080045700
0.1811			4.600	80.00	47.00	9002080046000
0.1831			4.650	80.00	47.00	9002080046500
0.1850		13	4.700	80.00	47.00	9002080047000
0.1870			4.750	80.00	47.00	9002080047500
0.1874	3/16		4.760	86.00	52.00	9002080047600
0.1890		12	4.800	86.00	52.00	9002080048000
0.1909		11	4.850	86.00	52.00	9002080048500
0.1929			4.900	86.00	52.00	9002080049000
0.1937		10	4.920	86.00	52.00	9002080049200
0.1949			4.950	86.00	52.00	9002080049500
0.1961		9	4.980	86.00	52.00	9002080049800
0.1969			5.000	86.00	52.00	9002080050000
0.1992		8	5.060	86.00	52.00	9002080050600
0.2008			5.100	86.00	52.00	9002080051000
0.2012		7	5.110	86.00	52.00	9002080051100
0.2031	13/64		5.160	86.00	52.00	9002080051600
0.2039		6	5.180	86.00	52.00	9002080051800
0.2047			5.200	86.00	52.00	9002080052000
0.2055		5	5.220	86.00	52.00	9002080052200
0.2067			5.250	86.00	52.00	9002080052500
0.2087			5.300	86.00	52.00	9002080053000
0.2126			5.400	93.00	57.00	9002080054000
0.2165			5.500	93.00	57.00	9002080055000
0.2189	7/32		5.560	93.00	57.00	9002080055600
0.2205			5.600	93.00	57.00	9002080056000
0.2209		2	5.610	93.00	57.00	9002080056100
0.2244			5.700	93.00	57.00	9002080057000
0.2264			5.750	93.00	57.00	9002080057500
0.2283			5.800	93.00	57.00	9002080058000
0.2303			5.850	93.00	57.00	9002080058500
0.2323			5.900	93.00	57.00	9002080059000
0.2339		A	5.940	93.00	57.00	9002080059400
0.2343	15/64		5.950	93.00	57.00	9002080059500
0.2362			6.000	93.00	57.00	9002080060000
0.2382			6.050	101.00	63.00	9002080060500
0.2402			6.100	101.00	63.00	9002080061000
0.2441			6.200	101.00	63.00	9002080062000
0.2461		D	6.250	101.00	63.00	9002080062500
0.2480			6.300	101.00	63.00	9002080063000
0.2500	1/4	E	6.350	101.00	63.00	9002080063500
0.2520			6.400	101.00	63.00	9002080064000
0.2559			6.500	101.00	63.00	9002080065000
0.2598			6.600	101.00	63.00	9002080066000
0.2638			6.700	101.00	63.00	9002080067000
0.2657	17/64	H	6.750	109.00	69.00	9002080067500
0.2677			6.800	109.00	69.00	9002080068000
0.2717		I	6.900	109.00	69.00	9002080069000

*Items listed in red are non-stocked items, and may take 2 - 6 weeks to receive

Series 208

Speeds & Feeds information pg 425

Diameter (d1)						
Dec. inch	Fract. inch	Wire / letter	mm	l1 mm	l2 mm	EDP #
0.2756			7.000	109.00	69.00	9002080070000
0.2768		J	7.030	109.00	69.00	9002080070300
0.2795			7.100	109.00	69.00	9002080071000
0.2811	9/32	K	7.140	109.00	69.00	9002080071400
0.2835			7.200	109.00	69.00	9002080072000
0.2874			7.300	109.00	69.00	9002080073000
0.2913			7.400	109.00	69.00	9002080074000
0.2953			7.500	109.00	69.00	9002080075000
0.2969	19/64		7.540	117.00	75.00	9002080075400
0.2992			7.600	117.00	75.00	9002080076000
0.3031			7.700	117.00	75.00	9002080077000
0.3051			7.750	117.00	75.00	9002080077500
0.3071			7.800	117.00	75.00	9002080078000
0.3091			7.850	117.00	75.00	9002080078500
0.3110			7.900	117.00	75.00	9002080079000
0.3126	5/16		7.940	117.00	75.00	9002080079400
0.3150			8.000	117.00	75.00	9002080080000
0.3189			8.100	117.00	75.00	9002080081000
0.3228		P	8.200	117.00	75.00	9002080082000
0.3268			8.300	117.00	75.00	9002080083000
0.3280	21/64		8.330	117.00	75.00	9002080083300
0.3307			8.400	117.00	75.00	9002080084000
0.3319		Q	8.430	117.00	75.00	9002080084300
0.3346			8.500	117.00	75.00	9002080085000
0.3386			8.600	125.00	81.00	9002080086000
0.3425			8.700	125.00	81.00	9002080087000
0.3465			8.800	125.00	81.00	9002080088000
0.3504			8.900	125.00	81.00	9002080089000
0.3543			9.000	125.00	81.00	9002080090000
0.3583			9.100	125.00	81.00	9002080091000
0.3622			9.200	125.00	81.00	9002080092000
0.3661			9.300	125.00	81.00	9002080093000
0.3701			9.400	125.00	81.00	9002080094000
0.3740			9.500	125.00	81.00	9002080095000
0.3748	3/8		9.520	133.00	87.00	9002080095200
0.3780			9.600	133.00	87.00	9002080096000
0.3819			9.700	133.00	87.00	9002080097000
0.3839			9.750	133.00	87.00	9002080097500
0.3858		W	9.800	133.00	87.00	9002080098000
0.3898			9.900	133.00	87.00	9002080099000
0.3906	25/64		9.920	133.00	87.00	9002080099200
0.3937			10.000	133.00	87.00	9002080100000
0.3976			10.100	133.00	87.00	9002080101000

Diameter (d1)						
Dec. inch	Fract. inch	Wire / letter	mm	l1 mm	l2 mm	EDP #
0.4016			10.200	133.00	87.00	9002080102000
0.4035			10.250	133.00	87.00	9002080102500
0.4055			10.300	133.00	87.00	9002080103000
0.4063	13/32		10.320	133.00	87.00	9002080103200
0.4094			10.400	133.00	87.00	9002080104000
0.4134			10.500	133.00	87.00	9002080105000
0.4173			10.600	133.00	87.00	9002080106000
0.4213			10.700	142.00	94.00	9002080107000
0.4220	27/64		10.720	142.00	94.00	9002080107200
0.4232			10.750	142.00	94.00	9002080107500
0.4331			11.000	142.00	94.00	9002080110000
0.4374	7/16		11.110	142.00	94.00	9002080111100
0.4409			11.200	142.00	94.00	9002080112000
0.4449			11.300	142.00	94.00	9002080113000
0.4528			11.500	142.00	94.00	9002080115000
0.4531	29/64		11.510	142.00	94.00	9002080115100
0.4646			11.800	142.00	94.00	9002080118000
0.4685			11.900	151.00	101.00	9002080119000
0.4689	15/32		11.910	151.00	101.00	9002080119100
0.4724			12.000	151.00	101.00	9002080120000
0.4764			12.100	151.00	101.00	9002080121000
0.4803			12.200	151.00	101.00	9002080122000
0.4823			12.250	151.00	101.00	9002080122500
0.4843	31/64		12.300	151.00	101.00	9002080123000
0.4882			12.400	151.00	101.00	9002080124000
0.4921			12.500	151.00	101.00	9002080125000
0.4961			12.600	151.00	101.00	9002080126000
0.5000	1/2		12.700	151.00	101.00	9002080127000
0.5118			13.000	151.00	101.00	9002080130000
0.5217			13.250	160.00	108.00	9002080132500
0.5276			13.400	160.00	108.00	9002080134000
0.5669			14.400	169.00	114.00	9002080144000
0.5787			14.700	169.00	114.00	9002080147000
0.5827			14.800	169.00	114.00	9002080148000
0.6004			15.250	178.00	120.00	9002080152500
0.6102			15.500	178.00	120.00	9002080155000
0.6248	5/8		15.870	178.00	120.00	9002080158700
0.6299			16.000	178.00	120.00	9002080160000

Alternative Drill Series:

#308 Cobalt, GP Low LH Helix, 5xD, 118 pt, Oxide
 #664 HSS, GP Low LH Helix, 5xD, 118 pt, TiN

10xD



Steam Oxide
>2.36 mm dia.



External Coolant



Straight Shank

Speeds & Feeds
information pg 426

Series 217

General Purpose

HSS, general purpose (Type N), taper length, 118° point, Form A web thinned
>14.0mm dia., standard straight shank, RH helix

Cut / Shank Dia. = h8 tolerance range

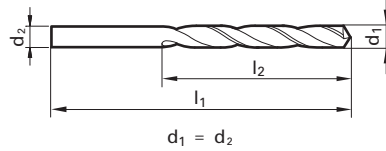

Application Materials:



General Steels/Brass



Universal Steels



Cast Iron

Twist Drills



Dec. inch	Diameter (d1)		l1 mm	l2 mm	EDP #
	Fract. inch	Wire / letter			
0.0157	1/64		30.00	10.00	9002170004000
0.0173			30.00	10.00	9002170004400
0.0185			30.00	10.00	9002170004700
0.0197			32.00	12.00	9002170005000
0.0205			32.00	12.00	9002170005200
0.0217			35.00	15.00	9002170005500
0.0224		74	35.00	15.00	9002170005700
0.0236			35.00	15.00	9002170006000
0.0244			38.00	18.00	9002170006200
0.0256			38.00	18.00	9002170006500
0.0276			42.00	21.00	9002170007000
0.0287			42.00	21.00	9002170007300
0.0295			42.00	21.00	9002170007500
0.0299			46.00	25.00	9002170007600
0.0311	1/32	68	46.00	25.00	9002170007900
0.0315			46.00	25.00	9002170008000
0.0323			46.00	25.00	9002170008200
0.0335			46.00	25.00	9002170008500
0.0354			51.00	29.00	9002170009000
0.0362			51.00	29.00	9002170009200
0.0374			51.00	29.00	9002170009500
0.0382		62	56.00	33.00	9002170009700
0.0394			56.00	33.00	9002170010000
0.0402		60	56.00	33.00	9002170010200
0.0409		59	56.00	33.00	9002170010400
0.0413			56.00	33.00	9002170010500
0.0421		58	60.00	37.00	9002170010700
0.0429		57	60.00	37.00	9002170010900
0.0433			60.00	37.00	9002170011000
0.0441			60.00	37.00	9002170011200
0.0453			60.00	37.00	9002170011500
0.0465		56	60.00	37.00	9002170011800
0.0469	3/64		65.00	41.00	9002170011900
0.0472			65.00	41.00	9002170012000
0.0492			65.00	41.00	9002170012500
0.0512			65.00	41.00	9002170013000
0.0520		55	65.00	41.00	9002170013200
0.0531			70.00	45.00	9002170013500
0.0551		54	70.00	45.00	9002170014000
0.0571			70.00	45.00	9002170014500
0.0591			70.00	45.00	9002170015000
0.0594		53	76.00	50.00	9002170015100
0.0610			76.00	50.00	9002170015500
0.0626	1/16		76.00	50.00	9002170015900
0.0630			76.00	50.00	9002170016000
0.0634		52	76.00	50.00	9002170016100
0.0650			76.00	50.00	9002170016500
0.0669		51	76.00	50.00	9002170017000
0.0689			80.00	53.00	9002170017500
0.0701		50	80.00	53.00	9002170017800
0.0709			80.00	53.00	9002170018000
0.0728		49	80.00	53.00	9002170018500
0.0748			80.00	53.00	9002170019000
0.0760		48	85.00	56.00	9002170019300

Dec. inch	Diameter (d1)		l1 mm	l2 mm	EDP #
	Fract. inch	Wire / letter			
0.0768			85.00	56.00	9002170019500
0.0780	5/64		85.00	56.00	9002170019800
0.0783		47	85.00	56.00	9002170019900
0.0787			85.00	56.00	9002170020000
0.0799			85.00	56.00	9002170020300
0.0807			85.00	56.00	9002170020500
0.0811		46	85.00	56.00	9002170020600
0.0819		45	85.00	56.00	9002170020800
0.0827			85.00	56.00	9002170021000
0.0846			90.00	59.00	9002170021500
0.0858		44	90.00	59.00	9002170021800
0.0866			90.00	59.00	9002170022000
0.0886			90.00	59.00	9002170022500
0.0890		43	90.00	59.00	9002170022600
0.0906			90.00	59.00	9002170023000
0.0913			90.00	59.00	9002170023200
0.0925			90.00	59.00	9002170023500
0.0933		42	95.00	62.00	9002170023700
0.0937	3/32		95.00	62.00	9002170023800
0.0945			95.00	62.00	9002170024000
0.0961		41	95.00	62.00	9002170024400
0.0965			95.00	62.00	9002170024500
0.0980		40	95.00	62.00	9002170024900
0.0984			95.00	62.00	9002170025000
0.0996		39	95.00	62.00	9002170025300
0.1004			95.00	62.00	9002170025500
0.1016		38	95.00	62.00	9002170025800
0.1024			95.00	62.00	9002170026000
0.1031			95.00	62.00	9002170026200
0.1039		37	95.00	62.00	9002170026400
0.1043			95.00	62.00	9002170026500
0.1063			100.00	66.00	9002170027000
0.1067		36	100.00	66.00	9002170027100
0.1083			100.00	66.00	9002170027500
0.1094	7/64		100.00	66.00	9002170027800
0.1098		35	100.00	66.00	9002170027900
0.1102			100.00	66.00	9002170028000
0.1110		34	100.00	66.00	9002170028200
0.1122			100.00	66.00	9002170028500
0.1130		33	100.00	66.00	9002170028700
0.1142			100.00	66.00	9002170029000
0.1161		32	100.00	66.00	9002170029500
0.1181			100.00	66.00	9002170030000
0.1201		31	106.00	69.00	9002170030500
0.1220			106.00	69.00	9002170031000
0.1240			106.00	69.00	9002170031500
0.1248	1/8		106.00	69.00	9002170031700
0.1260			106.00	69.00	9002170032000
0.1280			106.00	69.00	9002170032500
0.1283		30	106.00	69.00	9002170032600
0.1299			106.00	69.00	9002170033000
0.1319			106.00	69.00	9002170033500
0.1339			112.00	73.00	9002170034000
0.1358		29	112.00	73.00	9002170034500

*Items listed in red are non-stocked items, and may take 2 - 6 weeks to receive

Series 217

Speeds & Feeds information pg 426

Twist Drills

Diameter (d1)		Wire / letter	I1 mm	I2 mm	EDP #	
Dec. inch	Fract. inch					
0.1378			3.500	112.00	73.00	9002170035000
0.1398			3.550	112.00	73.00	9002170035500
0.1406	9/64	28	3.570	112.00	73.00	9002170035700
0.1417			3.600	112.00	73.00	9002170036000
0.1437			3.650	112.00	73.00	9002170036500
0.1441		27	3.660	112.00	73.00	9002170036600
0.1457			3.700	112.00	73.00	9002170037000
0.1469		26	3.730	112.00	73.00	9002170037300
0.1476			3.750	112.00	73.00	9002170037500
0.1496		25	3.800	119.00	78.00	9002170038000
0.1516			3.850	119.00	78.00	9002170038500
0.1520		24	3.860	119.00	78.00	9002170038600
0.1535			3.900	119.00	78.00	9002170039000
0.1539		23	3.910	119.00	78.00	9002170039100
0.1555			3.950	119.00	78.00	9002170039500
0.1563	5/32		3.970	119.00	78.00	9002170039700
0.1571		22	3.990	119.00	78.00	9002170039900
0.1575			4.000	119.00	78.00	9002170040000
0.1591		21	4.040	119.00	78.00	9002170040400
0.1594			4.050	119.00	78.00	9002170040500
0.1610		20	4.090	119.00	78.00	9002170040900
0.1614			4.100	119.00	78.00	9002170041000
0.1634			4.150	119.00	78.00	9002170041500
0.1654			4.200	119.00	78.00	9002170042000
0.1661		19	4.220	119.00	78.00	9002170042200
0.1673			4.250	119.00	78.00	9002170042500
0.1693		18	4.300	126.00	82.00	9002170043000
0.1713			4.350	126.00	82.00	9002170043500
0.1720	11/64		4.370	126.00	82.00	9002170043700
0.1728		17	4.390	126.00	82.00	9002170043900
0.1732			4.400	126.00	82.00	9002170044000
0.1752			4.450	126.00	82.00	9002170044500
0.1772		16	4.500	126.00	82.00	9002170045000
0.1799		15	4.570	126.00	82.00	9002170045700
0.1811			4.600	126.00	82.00	9002170046000
0.1819		14	4.620	126.00	82.00	9002170046200
0.1831			4.650	126.00	82.00	9002170046500
0.1850		13	4.700	126.00	82.00	9002170047000
0.1870			4.750	126.00	82.00	9002170047500
0.1874	3/16		4.760	132.00	87.00	9002170047600
0.1890		12	4.800	132.00	87.00	9002170048000
0.1909		11	4.850	132.00	87.00	9002170048500
0.1929			4.900	132.00	87.00	9002170049000
0.1937		10	4.920	132.00	87.00	9002170049200
0.1949			4.950	132.00	87.00	9002170049500
0.1961		9	4.980	132.00	87.00	9002170049800
0.1969			5.000	132.00	87.00	9002170050000
0.1988			5.050	132.00	87.00	9002170050500
0.1992		8	5.060	132.00	87.00	9002170050600
0.2008			5.100	132.00	87.00	9002170051000
0.2012		7	5.110	132.00	87.00	9002170051100
0.2028			5.150	132.00	87.00	9002170051500
0.2031	13/64		5.160	132.00	87.00	9002170051600
0.2039		6	5.180	132.00	87.00	9002170051800
0.2047			5.200	132.00	87.00	9002170052000
0.2055		5	5.220	132.00	87.00	9002170052200
0.2067			5.250	132.00	87.00	9002170052500
0.2087			5.300	132.00	87.00	9002170053000
0.2091		4	5.310	139.00	91.00	9002170053100
0.2106			5.350	139.00	91.00	9002170053500
0.2126			5.400	139.00	91.00	9002170054000
0.2130		3	5.410	139.00	91.00	9002170054100
0.2146			5.450	139.00	91.00	9002170054500
0.2165			5.500	139.00	91.00	9002170055000
0.2185			5.550	139.00	91.00	9002170055500
0.2189	7/32		5.560	139.00	91.00	9002170055600
0.2205			5.600	139.00	91.00	9002170056000
0.2209		2	5.610	139.00	91.00	9002170056100
0.2224			5.650	139.00	91.00	9002170056500
0.2244			5.700	139.00	91.00	9002170057000

Diameter (d1)		Wire / letter	I1 mm	I2 mm	EDP #	
Dec. inch	Fract. inch					
0.2264			5.750	139.00	91.00	9002170057500
0.2280		1	5.790	139.00	91.00	9002170057900
0.2283			5.800	139.00	91.00	9002170058000
0.2303			5.850	139.00	91.00	9002170058500
0.2323			5.900	139.00	91.00	9002170059000
0.2339		A	5.940	139.00	91.00	9002170059400
0.2343	15/64		5.950	139.00	91.00	9002170059500
0.2362			6.000	139.00	91.00	9002170060000
0.2378		B	6.040	148.00	97.00	9002170060400
0.2402			6.100	148.00	97.00	9002170061000
0.2421		C	6.150	148.00	97.00	9002170061500
0.2441			6.200	148.00	97.00	9002170062000
0.2461		D	6.250	148.00	97.00	9002170062500
0.2480			6.300	148.00	97.00	9002170063000
0.2500	1/4	E	6.350	148.00	97.00	9002170063500
0.2520			6.400	148.00	97.00	9002170064000
0.2559			6.500	148.00	97.00	9002170065000
0.2571		F	6.530	148.00	97.00	9002170065300
0.2598			6.600	148.00	97.00	9002170066000
0.2610		G	6.630	148.00	97.00	9002170066300
0.2638			6.700	148.00	97.00	9002170067000
0.2657	17/64	H	6.750	156.00	102.00	9002170067500
0.2677			6.800	156.00	102.00	9002170068000
0.2717		I	6.900	156.00	102.00	9002170069000
0.2756			7.000	156.00	102.00	9002170070000
0.2768		J	7.030	156.00	102.00	9002170070300
0.2795			7.100	156.00	102.00	9002170071000
0.2811	9/32	K	7.140	156.00	102.00	9002170071400
0.2835			7.200	156.00	102.00	9002170072000
0.2854			7.250	156.00	102.00	9002170072500
0.2874			7.300	156.00	102.00	9002170073000
0.2902		L	7.370	156.00	102.00	9002170073700
0.2913			7.400	156.00	102.00	9002170074000
0.2953			7.500	156.00	102.00	9002170075000
0.2969	19/64		7.540	165.00	109.00	9002170075400
0.2992			7.600	165.00	109.00	9002170076000
0.3020		N	7.670	165.00	109.00	9002170076700
0.3031			7.700	165.00	109.00	9002170077000
0.3051			7.750	165.00	109.00	9002170077500
0.3071			7.800	165.00	109.00	9002170078000
0.3110			7.900	165.00	109.00	9002170079000
0.3126	5/16		7.940	165.00	109.00	9002170079400
0.3150			8.000	165.00	109.00	9002170080000
0.3161		O	8.030	165.00	109.00	9002170080300
0.3189			8.100	165.00	109.00	9002170081000
0.3228		P	8.200	165.00	109.00	9002170082000
0.3248			8.250	165.00	109.00	9002170082500
0.3268			8.300	165.00	109.00	9002170083000
0.3280	21/64		8.330	165.00	109.00	9002170083300
0.3307			8.400	165.00	109.00	9002170084000
0.3319		Q	8.430	165.00	109.00	9002170084300
0.3346			8.500	165.00	109.00	9002170085000
0.3386			8.600	175.00	115.00	9002170086000
0.3390		R	8.610	175.00	115.00	9002170086100
0.3425			8.700	175.00	115.00	9002170087000
0.3437	11/32		8.730	175.00	115.00	9002170087300
0.3445			8.750	175.00	115.00	9002170087500
0.3465			8.800	175.00	115.00	9002170088000
0.3480		S	8.840	175.00	115.00	9002170088400
0.3504			8.900	175.00	115.00	9002170089000
0.3543			9.000	175.00	115.00	9002170090000
0.3583			9.100	175.00	115.00	9002170091000
0.3594	23/64		9.130	175.00	115.00	9002170091300
0.3622			9.200	175.00	115.00	9002170092000
0.3642			9.250	175.00	115.00	9002170092500
0.3661			9.300	175.00	115.00	9002170093000
0.3677		U	9.340	175.00	115.00	9002170093400
0.3701			9.400	175.00	115.00	9002170094000
0.3740			9.500	175.00	115.00	9002170095000
0.3748	3/8		9.520	184.00	121.00	9002170095200

Series 217

Speeds & Feeds information pg 426

Twist Drills

Diameter (d1)		Wire / letter	I1 mm	I2 mm	EDP #	
Dec. inch	Fract. inch					
0.3780			9.600	184.00	121.00	9002170096000
0.3819			9.700	184.00	121.00	9002170097000
0.3839			9.750	184.00	121.00	9002170097500
0.3858		W	9.800	184.00	121.00	9002170098000
0.3898			9.900	184.00	121.00	9002170099000
0.3906	25/64		9.920	184.00	121.00	9002170099200
0.3937			10.000	184.00	121.00	9002170100000
0.3969		X	10.080	184.00	121.00	9002170100800
0.3976			10.100	184.00	121.00	9002170101000
0.4016			10.200	184.00	121.00	9002170102000
0.4035			10.250	184.00	121.00	9002170102500
0.4039		Y	10.260	184.00	121.00	9002170102600
0.4055			10.300	184.00	121.00	9002170103000
0.4063	13/32		10.320	184.00	121.00	9002170103200
0.4094			10.400	184.00	121.00	9002170104000
0.4130		Z	10.490	184.00	121.00	9002170104900
0.4134			10.500	184.00	121.00	9002170105000
0.4173			10.600	184.00	121.00	9002170106000
0.4213			10.700	195.00	128.00	9002170107000
0.4220	27/64		10.720	195.00	128.00	9002170107200
0.4232			10.750	195.00	128.00	9002170107500
0.4252			10.800	195.00	128.00	9002170108000
0.4291			10.900	195.00	128.00	9002170109000
0.4331			11.000	195.00	128.00	9002170110000
0.4374	7/16		11.110	195.00	128.00	9002170111100
0.4409			11.200	195.00	128.00	9002170112000
0.4429			11.250	195.00	128.00	9002170112500
0.4449			11.300	195.00	128.00	9002170113000
0.4488			11.400	195.00	128.00	9002170114000
0.4528			11.500	195.00	128.00	9002170115000
0.4531	29/64		11.510	195.00	128.00	9002170115100
0.4567			11.600	195.00	128.00	9002170116000
0.4626			11.750	195.00	128.00	9002170117500
0.4646			11.800	195.00	128.00	9002170118000
0.4689	15/32		11.910	205.00	134.00	9002170119100
0.4724			12.000	205.00	134.00	9002170120000
0.4764			12.100	205.00	134.00	9002170121000
0.4803			12.200	205.00	134.00	9002170122000
0.4823			12.250	205.00	134.00	9002170122500
0.4843	31/64		12.300	205.00	134.00	9002170123000
0.4921			12.500	205.00	134.00	9002170125000
0.5000	1/2		12.700	205.00	134.00	9002170127000
0.5020			12.750	205.00	134.00	9002170127500
0.5039			12.800	205.00	134.00	9002170128000
0.5118			13.000	205.00	134.00	9002170130000
0.5157	33/64		13.100	205.00	134.00	9002170131000
0.5197			13.200	205.00	134.00	9002170132000
0.5311	17/32		13.490	214.00	140.00	9002170134900
0.5315			13.500	214.00	140.00	9002170135000
0.5413			13.750	214.00	140.00	9002170137500
0.5433			13.800	214.00	140.00	9002170138000
0.5469	35/64		13.890	214.00	140.00	9002170138900
0.5512			14.000	214.00	140.00	9002170140000
0.5591			14.200	220.00	144.00	9002170142000
0.5610			14.250	220.00	144.00	9002170142500
0.5626	9/16		14.290	220.00	144.00	9002170142900

Diameter (d1)		Wire / letter	I1 mm	I2 mm	EDP #	
Dec. inch	Fract. inch					
0.5709			14.500	220.00	144.00	9002170145000
0.5780	37/64		14.680	220.00	144.00	9002170146800
0.5906			15.000	220.00	144.00	9002170150000
0.5937	19/32		15.080	227.00	149.00	9002170150800
0.6004			15.250	227.00	149.00	9002170152500
0.6063			15.400	227.00	149.00	9002170154000
0.6094	39/64		15.480	227.00	149.00	9002170154800
0.6102			15.500	227.00	149.00	9002170155000
0.6248	5/8		15.870	227.00	149.00	9002170158700
0.6299			16.000	227.00	149.00	9002170160000
0.6406	41/64		16.270	235.00	154.00	9002170162700
0.6496			16.500	235.00	154.00	9002170165000
0.6563	21/32		16.670	235.00	154.00	9002170166700
0.6693			17.000	235.00	154.00	9002170170000
0.6720	43/64		17.070	241.00	158.00	9002170170700
0.6874	11/16		17.460	241.00	158.00	9002170174600
0.6890			17.500	241.00	158.00	9002170175000
0.7031	45/64		17.860	241.00	158.00	9002170178600
0.7087			18.000	241.00	158.00	9002170180000
0.7185			18.250	247.00	162.00	9002170182500
0.7189	23/32		18.260	247.00	162.00	9002170182600
0.7283			18.500	247.00	162.00	9002170185000
0.7343	47/64		18.650	247.00	162.00	9002170186500
0.7480			19.000	247.00	162.00	9002170190000
0.7500	3/4		19.050	254.00	166.00	9002170190500
0.7657	49/64		19.450	254.00	166.00	9002170194500
0.7677			19.500	254.00	166.00	9002170195000
0.7811	25/32		19.840	254.00	166.00	9002170198400
0.7874			20.000	254.00	166.00	9002170200000
0.7969	51/64		20.240	261.00	171.00	9002170202400
0.8071			20.500	261.00	171.00	9002170205000
0.8126	13/16		20.640	261.00	171.00	9002170206400
0.8169			20.750	261.00	171.00	9002170207500
0.8268			21.000	261.00	171.00	9002170210000
0.8280	53/64		21.030	268.00	176.00	9002170210300
0.8465			21.500	268.00	176.00	9002170215000
0.8594	55/64		21.830	268.00	176.00	9002170218300
0.8661			22.000	268.00	176.00	9002170220000
0.8748	7/8		22.220	268.00	176.00	9002170222200
0.8906	57/64		22.620	282.00	185.00	9002170226200
0.9063	29/32		23.020	282.00	185.00	9002170230200
0.9374	15/16		23.810	282.00	185.00	9002170238100
0.9449			24.000	282.00	185.00	9002170240000
0.9689	31/32		24.610	282.00	185.00	9002170246100
0.9843	63/64		25.000	282.00	185.00	9002170250000

Alternative Drill Series:

- #667 HSS, GP, 10xD, 118 pt, TiN
- #317 Cobalt, GP, 10xD, 118 pt, Oxide
- #617 Cobalt, Ti, 10xD, 130 pt, Bright
- #669 Cobalt, Ti, 10xD, 130 pt, TiN

*Items listed in red are non-stocked items, and may take 2 - 6 weeks to receive

10xD

Series 219

Application Materials:



High Helix

HSS, High Helix (Type W), taper length, 130° point, Form A web thinned >14.0mm dia., standard straight shank, RH helix

Cut / Shank Dia. = h8 tolerance range

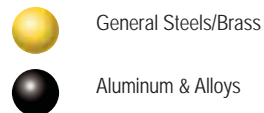
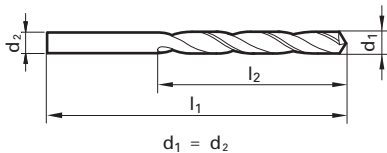

Speeds & Feeds
information pg 426

Dec. inch	Diameter (d1)		l1 mm	l2 mm	EDP #
	Fract. inch	Wire / letter			
0.0157	1/64		30.00	10.00	900219004000
0.0197			32.00	12.00	9002190005000
0.0236			35.00	15.00	9002190006000
0.0256			38.00	18.00	9002190006500
0.0276			42.00	21.00	9002190007000
0.0291		69	42.00	21.00	9002190007400
0.0295			42.00	21.00	9002190007500
0.0315			46.00	25.00	9002190008000
0.0335			46.00	25.00	9002190008500
0.0354			51.00	29.00	9002190009000
0.0374			51.00	29.00	9002190009500
0.0394			56.00	33.00	9002190010000
0.0413			56.00	33.00	9002190010500
0.0433			60.00	37.00	9002190011000
0.0453			60.00	37.00	9002190011500
0.0472			65.00	41.00	9002190012000
0.0480			65.00	41.00	9002190012200
0.0492			65.00	41.00	9002190012500
0.0512			65.00	41.00	9002190013000
0.0531			70.00	45.00	9002190013500
0.0551		54	70.00	45.00	9002190014000
0.0571			70.00	45.00	9002190014500
0.0591			70.00	45.00	9002190015000
0.0610			76.00	50.00	9002190015500
0.0630			76.00	50.00	9002190016000
0.0650			76.00	50.00	9002190016500
0.0669		51	76.00	50.00	9002190017000
0.0689			80.00	53.00	9002190017500
0.0701		50	80.00	53.00	9002190017800
0.0709			80.00	53.00	9002190018000
0.0728		49	80.00	53.00	9002190018500
0.0748			80.00	53.00	9002190019000
0.0768			85.00	56.00	9002190019500
0.0780	5/64		85.00	56.00	9002190019800
0.0787			85.00	56.00	9002190020000
0.0807			85.00	56.00	9002190020500
0.0827			85.00	56.00	9002190021000
0.0846			90.00	59.00	9002190021500
0.0866			90.00	59.00	9002190022000
0.0886			90.00	59.00	9002190022500
0.0906			90.00	59.00	9002190023000
0.0925			90.00	59.00	9002190023500
0.0937	3/32		95.00	62.00	9002190023800
0.0945			95.00	62.00	9002190024000
0.0965			95.00	62.00	9002190024500
0.0984			95.00	62.00	9002190025000
0.1004			95.00	62.00	9002190025500
0.1024			95.00	62.00	9002190026000
0.1043			95.00	62.00	9002190026500
0.1063			100.00	66.00	9002190027000
0.1083			100.00	66.00	9002190027500
0.1102			100.00	66.00	9002190028000
0.1122			100.00	66.00	9002190028500
0.1142			100.00	66.00	9002190029000
0.1161		32	100.00	66.00	9002190029500

Dec. inch	Diameter (d1)		l1 mm	l2 mm	EDP #
	Fract. inch	Wire / letter			
0.1181			100.00	66.00	9002190030000
0.1220			106.00	69.00	9002190031000
0.1240			106.00	69.00	9002190031500
0.1248	1/8		106.00	69.00	9002190031700
0.1260			106.00	69.00	9002190032000
0.1280			106.00	69.00	9002190032500
0.1299			106.00	69.00	9002190033000
0.1319			106.00	69.00	9002190033500
0.1339			112.00	73.00	9002190034000
0.1358		29	112.00	73.00	9002190034500
0.1378			112.00	73.00	9002190035000
0.1398			112.00	73.00	9002190035500
0.1417			112.00	73.00	9002190036000
0.1437			112.00	73.00	9002190036500
0.1457			112.00	73.00	9002190037000
0.1476			112.00	73.00	9002190037500
0.1496		25	119.00	78.00	9002190038000
0.1535			119.00	78.00	9002190039000
0.1575			119.00	78.00	9002190040000
0.1614			119.00	78.00	9002190041000
0.1634			119.00	78.00	9002190041500
0.1654			119.00	78.00	9002190042000
0.1673			119.00	78.00	9002190042500
0.1693		18	126.00	82.00	9002190043000
0.1732			126.00	82.00	9002190044000
0.1772		16	126.00	82.00	9002190045000
0.1811			126.00	82.00	9002190046000
0.1850		13	126.00	82.00	9002190047000
0.1890		12	132.00	87.00	9002190048000
0.1929			132.00	87.00	9002190049000
0.1969			132.00	87.00	9002190050000
0.2008			132.00	87.00	9002190051000
0.2047			132.00	87.00	9002190052000
0.2087			132.00	87.00	9002190053000
0.2126			139.00	91.00	9002190054000
0.2165			139.00	91.00	9002190055000
0.2205			139.00	91.00	9002190056000
0.2244			139.00	91.00	9002190057000
0.2283			139.00	91.00	9002190058000
0.2323			139.00	91.00	9002190059000
0.2362			139.00	91.00	9002190060000
0.2402			148.00	97.00	9002190061000
0.2441			148.00	97.00	9002190062000
0.2461		D	148.00	97.00	9002190062500
0.2480			148.00	97.00	9002190063000
0.2520			148.00	97.00	9002190064000
0.2559			148.00	97.00	9002190065000
0.2598			148.00	97.00	9002190066000
0.2638			148.00	97.00	9002190067000
0.2677			156.00	102.00	9002190068000
0.2717		I	156.00	102.00	9002190069000
0.2756			156.00	102.00	9002190070000
0.2795			156.00	102.00	9002190071000
0.2835			156.00	102.00	9002190072000
0.2874			156.00	102.00	9002190073000

Series 219

Speeds & Feeds information pg 426

Twist Drills

Dec. inch	Diameter (d1)		l1 mm	l2 mm	EDP #	
	Fract. inch	Wire / letter				
0.2913			7.400	156.00	102.00	9002190074000
0.2953			7.500	156.00	102.00	9002190075000
0.3031			7.700	165.00	109.00	9002190077000
0.3071			7.800	165.00	109.00	9002190078000
0.3110			7.900	165.00	109.00	9002190079000
0.3150			8.000	165.00	109.00	9002190080000
0.3169			8.050	165.00	109.00	9002190080500
0.3189			8.100	165.00	109.00	9002190081000
0.3228		P	8.200	165.00	109.00	9002190082000
0.3268			8.300	165.00	109.00	9002190083000
0.3307			8.400	165.00	109.00	9002190084000
0.3346			8.500	165.00	109.00	9002190085000
0.3366			8.550	175.00	115.00	9002190085500
0.3386			8.600	175.00	115.00	9002190086000
0.3425			8.700	175.00	115.00	9002190087000
0.3465			8.800	175.00	115.00	9002190088000
0.3504			8.900	175.00	115.00	9002190089000
0.3543			9.000	175.00	115.00	9002190090000
0.3583			9.100	175.00	115.00	9002190091000
0.3622			9.200	175.00	115.00	9002190092000
0.3740			9.500	175.00	115.00	9002190095000
0.3819			9.700	184.00	121.00	9002190097000
0.3858		W	9.800	184.00	121.00	9002190098000

Dec. inch	Diameter (d1)		l1 mm	l2 mm	EDP #	
	Fract. inch	Wire / letter				
0.3937			10.000	184.00	121.00	9002190100000
0.4016			10.200	184.00	121.00	9002190102000
0.4134			10.500	184.00	121.00	9002190105000
0.4252			10.800	195.00	128.00	9002190108000
0.4331			11.000	195.00	128.00	9002190110000
0.4528			11.500	195.00	128.00	9002190115000
0.4724			12.000	205.00	134.00	9002190120000
0.4921			12.500	205.00	134.00	9002190125000
0.5118			13.000	205.00	134.00	9002190130000
0.5157	33/64		13.100	205.00	134.00	9002190131000
0.5512			14.000	214.00	140.00	9002190140000
0.5709			14.500	220.00	144.00	9002190145000
0.5906			15.000	220.00	144.00	9002190150000
0.6299			16.000	227.00	149.00	9002190160000
0.6693			17.000	235.00	154.00	9002190170000
0.7087			18.000	241.00	158.00	9002190180000
0.7480			19.000	247.00	162.00	9002190190000
0.7874			20.000	254.00	166.00	9002190200000

Alternative Drill Series:
#501 HSS, GT50, 10xD, 118 pt, Bright

*Items listed in red are non-stocked items, and may take 2 - 6 weeks to receive

3xD



Steam Oxide
>2.36 mm dia.



External Coolant



Straight Shank

Speeds & Feeds
information pg 427

Series 223

General Purpose

HSS, general purpose (Type N), stub length, 118° point, Form A web thinned
>14.0mm dia., standard straight shank, RH helix

Cut / Shank Dia. = h8 tolerance range

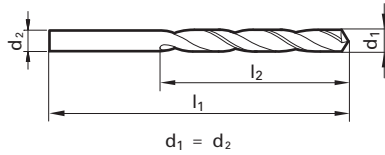

Application Materials:

- General Steels/Brass
- Universal Steels
- Cast Iron



Dec. inch	Diameter (d1)		l1 mm	l2 mm	EDP #	
	Fract. inch	Wire / letter				
0.0157	1/64		19.00	2.50	9002230004000	
0.0197			20.00	3.00	9002230005000	
0.0217			0.550	21.00	3.50	9002230005500
0.0236			0.600	21.00	3.50	9002230006000
0.0256			0.650	22.00	4.00	9002230006500
0.0260		71	0.660	22.00	4.00	9002230006600
0.0276			0.700	23.00	4.50	9002230007000
0.0283			0.720	23.00	4.50	9002230007200
0.0295			0.750	23.00	4.50	9002230007500
0.0311	1/32	68	0.790	24.00	5.00	9002230007900
0.0315			0.800	24.00	5.00	9002230008000
0.0323			0.820	24.00	5.00	9002230008200
0.0350		65	0.890	25.00	5.50	9002230008900
0.0354			0.900	25.00	5.50	9002230009000
0.0374			0.950	25.00	5.50	9002230009500
0.0386			0.980	26.00	6.00	9002230009800
0.0394			1.000	26.00	6.00	9002230010000
0.0402		60	1.020	26.00	6.00	9002230010200
0.0409		59	1.040	26.00	6.00	9002230010400
0.0413			1.050	26.00	6.00	9002230010500
0.0421		58	1.070	28.00	7.00	9002230010700
0.0429		57	1.090	28.00	7.00	9002230010900
0.0433			1.100	28.00	7.00	9002230011000
0.0453			1.150	28.00	7.00	9002230011500
0.0465		56	1.180	28.00	7.00	9002230011800
0.0469	3/64		1.190	28.00	7.00	9002230011900
0.0472			1.200	28.00	7.00	9002230012000
0.0492			1.250	28.00	7.00	9002230012500
0.0496			1.260	28.00	7.00	9002230012600
0.0504			1.280	28.00	7.00	9002230012800
0.0512			1.300	28.00	7.00	9002230013000
0.0520		55	1.320	28.00	7.00	9002230013200
0.0531			1.350	32.00	9.00	9002230013500
0.0551		54	1.400	32.00	9.00	9002230014000
0.0571			1.450	32.00	9.00	9002230014500
0.0591			1.500	32.00	9.00	9002230015000
0.0594		53	1.510	34.00	10.00	9002230015100
0.0598			1.520	34.00	10.00	9002230015200
0.0610			1.550	34.00	10.00	9002230015500
0.0626	1/16		1.590	34.00	10.00	9002230015900
0.0630			1.600	34.00	10.00	9002230016000
0.0634		52	1.610	34.00	10.00	9002230016100
0.0650			1.650	34.00	10.00	9002230016500
0.0669		51	1.700	34.00	10.00	9002230017000
0.0677			1.720	36.00	11.00	9002230017200
0.0685			1.740	36.00	11.00	9002230017400
0.0689			1.750	36.00	11.00	9002230017500
0.0701		50	1.780	36.00	11.00	9002230017800
0.0709			1.800	36.00	11.00	9002230018000
0.0728		49	1.850	36.00	11.00	9002230018500
0.0748			1.900	36.00	11.00	9002230019000
0.0760		48	1.930	38.00	12.00	9002230019300
0.0768			1.950	38.00	12.00	9002230019500
0.0776			1.970	38.00	12.00	9002230019700
0.0780	5/64		1.980	38.00	12.00	9002230019800

Dec. inch	Diameter (d1)		l1 mm	l2 mm	EDP #	
	Fract. inch	Wire / letter				
0.0783		47	1.990	38.00	12.00	9002230019900
0.0787			2.000	38.00	12.00	9002230020000
0.0807			2.050	38.00	12.00	9002230020500
0.0811		46	2.060	38.00	12.00	9002230020600
0.0819		45	2.080	38.00	12.00	9002230020800
0.0827			2.100	38.00	12.00	9002230021000
0.0835			2.120	38.00	12.00	9002230021200
0.0846			2.150	40.00	13.00	9002230021500
0.0858		44	2.180	40.00	13.00	9002230021800
0.0866			2.200	40.00	13.00	9002230022000
0.0874			2.220	40.00	13.00	9002230022200
0.0886			2.250	40.00	13.00	9002230022500
0.0890		43	2.260	40.00	13.00	9002230022600
0.0906			2.300	40.00	13.00	9002230023000
0.0925			2.350	40.00	13.00	9002230023500
0.0933		42	2.370	43.00	14.00	9002230023700
0.0937	3/32		2.380	43.00	14.00	9002230023800
0.0945			2.400	43.00	14.00	9002230024000
0.0961		41	2.440	43.00	14.00	9002230024400
0.0965			2.450	43.00	14.00	9002230024500
0.0976			2.480	43.00	14.00	9002230024800
0.0980		40	2.490	43.00	14.00	9002230024900
0.0984			2.500	43.00	14.00	9002230025000
0.0996		39	2.530	43.00	14.00	9002230025300
0.1004			2.550	43.00	14.00	9002230025500
0.1016		38	2.580	43.00	14.00	9002230025800
0.1024			2.600	43.00	14.00	9002230026000
0.1039		37	2.640	43.00	14.00	9002230026400
0.1043			2.650	43.00	14.00	9002230026500
0.1063			2.700	46.00	16.00	9002230027000
0.1067		36	2.710	46.00	16.00	9002230027100
0.1083			2.750	46.00	16.00	9002230027500
0.1094	7/64		2.780	46.00	16.00	9002230027800
0.1098		35	2.790	46.00	16.00	9002230027900
0.1102			2.800	46.00	16.00	9002230028000
0.1110		34	2.820	46.00	16.00	9002230028200
0.1122			2.850	46.00	16.00	9002230028500
0.1130		33	2.870	46.00	16.00	9002230028700
0.1142			2.900	46.00	16.00	9002230029000
0.1150			2.920	46.00	16.00	9002230029200
0.1161		32	2.950	46.00	16.00	9002230029500
0.1169			2.970	46.00	16.00	9002230029700
0.1181			3.000	46.00	16.00	9002230030000
0.1201		31	3.050	49.00	18.00	9002230030500
0.1220			3.100	49.00	18.00	9002230031000
0.1240			3.150	49.00	18.00	9002230031500
0.1248	1/8		3.170	49.00	18.00	9002230031700
0.1260			3.200	49.00	18.00	9002230032000
0.1280			3.250	49.00	18.00	9002230032500
0.1283		30	3.260	49.00	18.00	9002230032600
0.1299			3.300	49.00	18.00	9002230033000
0.1319			3.350	49.00	18.00	9002230033500
0.1339			3.400	52.00	20.00	9002230034000
0.1358		29	3.450	52.00	20.00	9002230034500
0.1378			3.500	52.00	20.00	9002230035000

Series 223

Speeds & Feeds information pg 427

Diameter (d1)						
Dec. inch	Fract. inch	Wire / letter	mm	l1 mm	l2 mm	EDP #
0.1398			3.550	52.00	20.00	9002230035500
0.1406	9/64	28	3.570	52.00	20.00	9002230035700
0.1417			3.600	52.00	20.00	9002230036000
0.1437			3.650	52.00	20.00	9002230036500
0.1441		27	3.660	52.00	20.00	9002230036600
0.1457			3.700	52.00	20.00	9002230037000
0.1469		26	3.730	52.00	20.00	9002230037300
0.1476			3.750	52.00	20.00	9002230037500
0.1496		25	3.800	55.00	22.00	9002230038000
0.1516			3.850	55.00	22.00	9002230038500
0.1520		24	3.860	55.00	22.00	9002230038600
0.1535			3.900	55.00	22.00	9002230039000
0.1539		23	3.910	55.00	22.00	9002230039100
0.1555			3.950	55.00	22.00	9002230039500
0.1563	5/32		3.970	55.00	22.00	9002230039700
0.1571		22	3.990	55.00	22.00	9002230039900
0.1575			4.000	55.00	22.00	9002230040000
0.1583			4.020	55.00	22.00	9002230040200
0.1591		21	4.040	55.00	22.00	9002230040400
0.1610		20	4.090	55.00	22.00	9002230040900
0.1614			4.100	55.00	22.00	9002230041000
0.1634			4.150	55.00	22.00	9002230041500
0.1654			4.200	55.00	22.00	9002230042000
0.1661		19	4.220	55.00	22.00	9002230042200
0.1673			4.250	55.00	22.00	9002230042500
0.1693		18	4.300	58.00	24.00	9002230043000
0.1720	11/64		4.370	58.00	24.00	9002230043700
0.1728		17	4.390	58.00	24.00	9002230043900
0.1732			4.400	58.00	24.00	9002230044000
0.1752			4.450	58.00	24.00	9002230044500
0.1772		16	4.500	58.00	24.00	9002230045000
0.1791			4.550	58.00	24.00	9002230045500
0.1799		15	4.570	58.00	24.00	9002230045700
0.1811			4.600	58.00	24.00	9002230046000
0.1819		14	4.620	58.00	24.00	9002230046200
0.1850		13	4.700	58.00	24.00	9002230047000
0.1870			4.750	58.00	24.00	9002230047500
0.1874	3/16		4.760	62.00	26.00	9002230047600
0.1890		12	4.800	62.00	26.00	9002230048000
0.1909		11	4.850	62.00	26.00	9002230048500
0.1929			4.900	62.00	26.00	9002230049000
0.1937		10	4.920	62.00	26.00	9002230049200
0.1961		9	4.980	62.00	26.00	9002230049800
0.1969			5.000	62.00	26.00	9002230050000
0.1988			5.050	62.00	26.00	9002230050500
0.1992		8	5.060	62.00	26.00	9002230050600
0.2008			5.100	62.00	26.00	9002230051000
0.2012		7	5.110	62.00	26.00	9002230051100
0.2031	13/64		5.160	62.00	26.00	9002230051600
0.2039		6	5.180	62.00	26.00	9002230051800
0.2047			5.200	62.00	26.00	9002230052000
0.2055		5	5.220	62.00	26.00	9002230052200
0.2067			5.250	62.00	26.00	9002230052500
0.2087			5.300	62.00	26.00	9002230053000
0.2091		4	5.310	66.00	28.00	9002230053100
0.2106			5.350	66.00	28.00	9002230053500
0.2126			5.400	66.00	28.00	9002230054000
0.2130		3	5.410	66.00	28.00	9002230054100
0.2146			5.450	66.00	28.00	9002230054500
0.2165			5.500	66.00	28.00	9002230055000
0.2189	7/32		5.560	66.00	28.00	9002230055600
0.2205			5.600	66.00	28.00	9002230056000
0.2209		2	5.610	66.00	28.00	9002230056100
0.2244			5.700	66.00	28.00	9002230057000
0.2264			5.750	66.00	28.00	9002230057500
0.2280		1	5.790	66.00	28.00	9002230057900
0.2283			5.800	66.00	28.00	9002230058000
0.2323			5.900	66.00	28.00	9002230059000
0.2339		A	5.940	66.00	28.00	9002230059400

Diameter (d1)						
Dec. inch	Fract. inch	Wire / letter	mm	l1 mm	l2 mm	EDP #
0.2343	15/64		5.950	66.00	28.00	9002230059500
0.2362			6.000	66.00	28.00	9002230060000
0.2378		B	6.040	70.00	31.00	9002230060400
0.2382			6.050	70.00	31.00	9002230060500
0.2402			6.100	70.00	31.00	9002230061000
0.2421		C	6.150	70.00	31.00	9002230061500
0.2441			6.200	70.00	31.00	9002230062000
0.2461		D	6.250	70.00	31.00	9002230062500
0.2480			6.300	70.00	31.00	9002230063000
0.2500	1/4	E	6.350	70.00	31.00	9002230063500
0.2520			6.400	70.00	31.00	9002230064000
0.2559			6.500	70.00	31.00	9002230065000
0.2571		F	6.530	70.00	31.00	9002230065300
0.2598			6.600	70.00	31.00	9002230066000
0.2610		G	6.630	70.00	31.00	9002230066300
0.2638			6.700	70.00	31.00	9002230067000
0.2657	17/64	H	6.750	74.00	34.00	9002230067500
0.2677			6.800	74.00	34.00	9002230068000
0.2697			6.850	74.00	34.00	9002230068500
0.2717		I	6.900	74.00	34.00	9002230069000
0.2736			6.950	74.00	34.00	9002230069500
0.2756			7.000	74.00	34.00	9002230070000
0.2768		J	7.030	74.00	34.00	9002230070300
0.2795			7.100	74.00	34.00	9002230071000
0.2811	9/32	K	7.140	74.00	34.00	9002230071400
0.2835			7.200	74.00	34.00	9002230072000
0.2854			7.250	74.00	34.00	9002230072500
0.2874			7.300	74.00	34.00	9002230073000
0.2902		L	7.370	74.00	34.00	9002230073700
0.2913			7.400	74.00	34.00	9002230074000
0.2933			7.450	74.00	34.00	9002230074500
0.2949		M	7.490	74.00	34.00	9002230074900
0.2953			7.500	74.00	34.00	9002230075000
0.2969	19/64		7.540	79.00	37.00	9002230075400
0.2992			7.600	79.00	37.00	9002230076000
0.3020		N	7.670	79.00	37.00	9002230076700
0.3031			7.700	79.00	37.00	9002230077000
0.3051			7.750	79.00	37.00	9002230077500
0.3071			7.800	79.00	37.00	9002230078000
0.3091			7.850	79.00	37.00	9002230078500
0.3110			7.900	79.00	37.00	9002230079000
0.3126	5/16		7.940	79.00	37.00	9002230079400
0.3150			8.000	79.00	37.00	9002230080000
0.3161		O	8.030	79.00	37.00	9002230080300
0.3169			8.050	79.00	37.00	9002230080500
0.3189			8.100	79.00	37.00	9002230081000
0.3209			8.150	79.00	37.00	9002230081500
0.3228		P	8.200	79.00	37.00	9002230082000
0.3248			8.250	79.00	37.00	9002230082500
0.3268			8.300	79.00	37.00	9002230083000
0.3280	21/64		8.330	79.00	37.00	9002230083300
0.3307			8.400	79.00	37.00	9002230084000
0.3319		Q	8.430	79.00	37.00	9002230084300
0.3346			8.500	79.00	37.00	9002230085000
0.3386			8.600	84.00	40.00	9002230086000
0.3390		R	8.610	84.00	40.00	9002230086100
0.3406			8.650	84.00	40.00	9002230086500
0.3425			8.700	84.00	40.00	9002230087000
0.3437	11/32		8.730	84.00	40.00	9002230087300
0.3445			8.750	84.00	40.00	9002230087500
0.3465			8.800	84.00	40.00	9002230088000
0.3480		S	8.840	84.00	40.00	9002230088400
0.3504			8.900	84.00	40.00	9002230089000
0.3524			8.950	84.00	40.00	9002230089500
0.3543			9.000	84.00	40.00	9002230090000
0.3579		T	9.090	84.00	40.00	9002230090900
0.3583			9.100	84.00	40.00	9002230091000
0.3594	23/64		9.130	84.00	40.00	9002230091300
0.3622			9.200	84.00	40.00	9002230092000

*Items listed in red are non-stocked items, and may take 2 - 6 weeks to receive

Series 223

Speeds & Feeds information pg 427

Twist Drills

Dec. inch	Diameter (d1)		l1 mm	l2 mm	EDP #	
	Fract. inch	Wire / letter				
0.3642			9.250	84.00	40.00	9002230092500
0.3661			9.300	84.00	40.00	9002230093000
0.3677		U	9.340	84.00	40.00	9002230093400
0.3701			9.400	84.00	40.00	9002230094000
0.3740			9.500	84.00	40.00	9002230095000
0.3748	3/8		9.520	89.00	43.00	9002230095200
0.3772		V	9.580	89.00	43.00	9002230095800
0.3780			9.600	89.00	43.00	9002230096000
0.3799			9.650	89.00	43.00	9002230096500
0.3819			9.700	89.00	43.00	9002230097000
0.3839			9.750	89.00	43.00	9002230097500
0.3858		W	9.800	89.00	43.00	9002230098000
0.3898			9.900	89.00	43.00	9002230099000
0.3906	25/64		9.920	89.00	43.00	9002230099200
0.3937			10.000	89.00	43.00	9002230100000
0.3957			10.050	89.00	43.00	9002230100500
0.3969		X	10.080	89.00	43.00	9002230100800
0.3976			10.100	89.00	43.00	9002230101000
0.3996			10.150	89.00	43.00	9002230101500
0.4016			10.200	89.00	43.00	9002230102000
0.4035			10.250	89.00	43.00	9002230102500
0.4039		Y	10.260	89.00	43.00	9002230102600
0.4055			10.300	89.00	43.00	9002230103000
0.4063	13/32		10.320	89.00	43.00	9002230103200
0.4094			10.400	89.00	43.00	9002230104000
0.4130		Z	10.490	89.00	43.00	9002230104900
0.4134			10.500	89.00	43.00	9002230105000
0.4173			10.600	89.00	43.00	9002230106000
0.4213			10.700	95.00	47.00	9002230107000
0.4220	27/64		10.720	95.00	47.00	9002230107200
0.4232			10.750	95.00	47.00	9002230107500
0.4252			10.800	95.00	47.00	9002230108000
0.4291			10.900	95.00	47.00	9002230109000
0.4331			11.000	95.00	47.00	9002230110000
0.4370			11.100	95.00	47.00	9002230111000
0.4374	7/16		11.110	95.00	47.00	9002230111100
0.4409			11.200	95.00	47.00	9002230112000
0.4429			11.250	95.00	47.00	9002230112500
0.4449			11.300	95.00	47.00	9002230113000
0.4488			11.400	95.00	47.00	9002230114000
0.4528			11.500	95.00	47.00	9002230115000
0.4531	29/64		11.510	95.00	47.00	9002230115100
0.4567			11.600	95.00	47.00	9002230116000
0.4606			11.700	95.00	47.00	9002230117000
0.4626			11.750	95.00	47.00	9002230117500
0.4646			11.800	95.00	47.00	9002230118000
0.4685			11.900	102.00	51.00	9002230119000
0.4689	15/32		11.910	102.00	51.00	9002230119100
0.4724			12.000	102.00	51.00	9002230120000
0.4764			12.100	102.00	51.00	9002230121000
0.4783			12.150	102.00	51.00	9002230121500
0.4803			12.200	102.00	51.00	9002230122000
0.4823			12.250	102.00	51.00	9002230122500
0.4843	31/64		12.300	102.00	51.00	9002230123000
0.4882			12.400	102.00	51.00	9002230124000
0.4921			12.500	102.00	51.00	9002230125000
0.4961			12.600	102.00	51.00	9002230126000
0.5000	1/2		12.700	102.00	51.00	9002230127000
0.5020			12.750	102.00	51.00	9002230127500
0.5039			12.800	102.00	51.00	9002230128000
0.5079			12.900	102.00	51.00	9002230129000
0.5118			13.000	102.00	51.00	9002230130000
0.5157	33/64		13.100	102.00	51.00	9002230131000
0.5197			13.200	102.00	51.00	9002230132000
0.5217			13.250	107.00	54.00	9002230132500
0.5236			13.300	107.00	54.00	9002230133000
0.5276			13.400	107.00	54.00	9002230134000
0.5311	17/32		13.490	107.00	54.00	9002230134900
0.5315			13.500	107.00	54.00	9002230135000

Dec. inch	Diameter (d1)		l1 mm	l2 mm	EDP #	
	Fract. inch	Wire / letter				
0.5354			13.600	107.00	54.00	9002230136000
0.5394			13.700	107.00	54.00	9002230137000
0.5413			13.750	107.00	54.00	9002230137500
0.5433			13.800	107.00	54.00	9002230138000
0.5469	35/64		13.890	107.00	54.00	9002230138900
0.5472			13.900	107.00	54.00	9002230139000
0.5512			14.000	107.00	54.00	9002230140000
0.5551			14.100	111.00	56.00	9002230141000
0.5591			14.200	111.00	56.00	9002230142000
0.5610			14.250	111.00	56.00	9002230142500
0.5626	9/16		14.290	111.00	56.00	9002230142900
0.5669			14.400	111.00	56.00	9002230144000
0.5709			14.500	111.00	56.00	9002230145000
0.5748			14.600	111.00	56.00	9002230146000
0.5780	37/64		14.680	111.00	56.00	9002230146800
0.5807			14.750	111.00	56.00	9002230147500
0.5827			14.800	111.00	56.00	9002230148000
0.5866			14.900	111.00	56.00	9002230149000
0.5906			15.000	111.00	56.00	9002230150000
0.5937	19/32		15.080	115.00	58.00	9002230150800
0.5945			15.100	115.00	58.00	9002230151000
0.5984			15.200	115.00	58.00	9002230152000
0.6004			15.250	115.00	58.00	9002230152500
0.6063			15.400	115.00	58.00	9002230154000
0.6094	39/64		15.480	115.00	58.00	9002230154800
0.6102			15.500	115.00	58.00	9002230155000
0.6142			15.600	115.00	58.00	9002230156000
0.6181			15.700	115.00	58.00	9002230157000
0.6201			15.750	115.00	58.00	9002230157500
0.6220			15.800	115.00	58.00	9002230158000
0.6248	5/8		15.870	115.00	58.00	9002230158700
0.6299			16.000	115.00	58.00	9002230160000
0.6339			16.100	119.00	60.00	9002230161000
0.6358			16.150	119.00	60.00	9002230161500
0.6398			16.250	119.00	60.00	9002230162500
0.6406	41/64		16.270	119.00	60.00	9002230162700
0.6417			16.300	119.00	60.00	9002230163000
0.6496			16.500	119.00	60.00	9002230165000
0.6563	21/32		16.670	119.00	60.00	9002230166700
0.6594			16.750	119.00	60.00	9002230167500
0.6693			17.000	119.00	60.00	9002230170000
0.6720	43/64		17.070	123.00	62.00	9002230170700
0.6732			17.100	123.00	62.00	9002230171000
0.6791			17.250	123.00	62.00	9002230172500
0.6811			17.300	123.00	62.00	9002230173000
0.6874	11/16		17.460	123.00	62.00	9002230174600
0.6890			17.500	123.00	62.00	9002230175000
0.6929			17.600	123.00	62.00	9002230176000
0.6988			17.750	123.00	62.00	9002230177500
0.7031	45/64		17.860	123.00	62.00	9002230178600
0.7087			18.000	123.00	62.00	9002230180000
0.7126			18.100	127.00	64.00	9002230181000
0.7165			18.200	127.00	64.00	9002230182000
0.7185			18.250	127.00	64.00	9002230182500
0.7189	23/32		18.260	127.00	64.00	9002230182600
0.7283			18.500	127.00	64.00	9002230185000
0.7343	47/64		18.650	127.00	64.00	9002230186500
0.7382			18.750	127.00	64.00	9002230187500
0.7480			19.000	127.00	64.00	9002230190000
0.7500	3/4		19.050	131.00	66.00	9002230190500
0.7520			19.100	131.00	66.00	9002230191000
0.7579			19.250	131.00	66.00	9002230192500
0.7657	49/64		19.450	131.00	66.00	9002230194500
0.7677			19.500	131.00	66.00	9002230195000
0.7776			19.750	131.00	66.00	9002230197500
0.7811	25/32		19.840	131.00	66.00	9002230198400
0.7874			20.000	131.00	66.00	9002230200000
0.7913			20.100	136.00	68.00	9002230201000
0.7969	51/64		20.240	136.00	68.00	9002230202400

Series 223

Speeds & Feeds information pg 427

Dec. inch	Diameter (d1)		I1 mm	I2 mm	EDP #	
	Fract. inch	Wire / letter				
0.8071			20.500	136.00	68.00	9002230205000
0.8126	13/16		20.640	136.00	68.00	9002230206400
0.8169			20.750	136.00	68.00	9002230207500
0.8189			20.800	136.00	68.00	9002230208000
0.8268			21.000	136.00	68.00	9002230210000
0.8280	53/64		21.030	136.00	68.00	9002230210300
0.8366			21.250	141.00	70.00	9002230212500
0.8437	27/32		21.430	141.00	70.00	9002230214300
0.8465			21.500	141.00	70.00	9002230215000
0.8661			22.000	141.00	70.00	9002230220000
0.8748	7/8		22.220	141.00	70.00	9002230222200
0.8858			22.500	146.00	72.00	9002230225000
0.8906	57/64		22.620	146.00	72.00	9002230226200
0.9055			23.000	146.00	72.00	9002230230000
0.9063	29/32		23.020	146.00	72.00	9002230230200
0.9220	59/64		23.420	146.00	72.00	9002230234200
0.9252			23.500	146.00	72.00	9002230235000
0.9374	15/16		23.810	151.00	75.00	9002230238100
0.9449			24.000	151.00	75.00	9002230240000

Dec. inch	Diameter (d1)		I1 mm	I2 mm	EDP #	
	Fract. inch	Wire / letter				
0.9531	61/64		24.210	151.00	75.00	9002230242100
0.9646			24.500	151.00	75.00	9002230245000
0.9689	31/32		24.610	151.00	75.00	9002230246100
0.9843	63/64		25.000	151.00	75.00	9002230250000
1.0000	1		25.400	156.00	78.00	9002230254000
1.0311	1 1/32		26.190	156.00	78.00	9002230261900
1.0433			26.500	156.00	78.00	9002230265000
1.1024			28.000	162.00	81.00	9002230280000
1.1248	1 1/8		28.570	168.00	84.00	9002230285700
1.1563	1 5/32		29.370	168.00	84.00	9002230293700
1.1811			30.000	168.00	84.00	9002230300000
1.2500	1 1/4		31.750	180.00	90.00	9002230317500

Alternative Drill Series:					
#5524	Cobalt	GU500	3xD	118 pt	Bright
#653	HSS	GP	3xD	118 pt	TiN
#730	Carbide	GP	3xD	118 pt	Bright
#2463	Carbide	GP	3xD	118 pt	FIREX®

*Items listed in red are non-stocked items, and may take 2 - 6 weeks to receive

3xD



Bright Finish



External Coolant

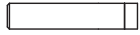

Straight Shank

Speeds & Feeds
information pg 427

Series 224

Low Helix

HSS, Low Helix (Type H), stub length, 118° point, Form A web thinned >14.0mm dia., standard straight shank, RH helix

Cut / Shank Dia. = h8 tolerance range

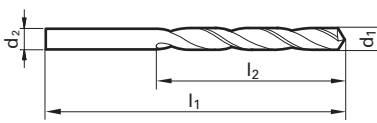

$$d_1 = d_2$$

Application Materials:



General Steels/Brass

Dec. inch	Diameter (d1)		l1 mm	l2 mm	EDP #
	Fract. inch	Wire / letter			
0.0354			25.00	5.50	900224009000
0.0394			26.00	6.00	9002240010000
0.0433			28.00	7.00	9002240011000
0.0472			28.00	7.00	9002240012000
0.0512			28.00	7.00	9002240013000
0.0551		54	32.00	9.00	9002240014000
0.0591			32.00	9.00	9002240015000
0.0610			34.00	10.00	9002240015500
0.0626	1/16		34.00	10.00	9002240015900
0.0630			34.00	10.00	9002240016000
0.0669		51	34.00	10.00	9002240017000
0.0701		50	36.00	11.00	9002240017800
0.0709			36.00	11.00	9002240018000
0.0748			36.00	11.00	9002240019000
0.0780	5/64		38.00	12.00	9002240019800
0.0787			38.00	12.00	9002240020000
0.0827			38.00	12.00	9002240021000
0.0866			40.00	13.00	9002240022000
0.0906			40.00	13.00	9002240023000
0.0937	3/32		43.00	14.00	9002240023800
0.0945			43.00	14.00	9002240024000
0.0965			43.00	14.00	9002240024500
0.0984			43.00	14.00	9002240025000
0.1004			43.00	14.00	9002240025500
0.1024			43.00	14.00	9002240026000
0.1043			43.00	14.00	9002240026500
0.1063			46.00	16.00	9002240027000
0.1094	7/64		46.00	16.00	9002240027800
0.1102			46.00	16.00	9002240028000
0.1142			46.00	16.00	9002240029000
0.1161		32	46.00	16.00	9002240029500
0.1181			46.00	16.00	9002240030000
0.1220			49.00	18.00	9002240031000
0.1248	1/8		49.00	18.00	9002240031700
0.1260			49.00	18.00	9002240032000
0.1299			49.00	18.00	9002240033000
0.1319			49.00	18.00	9002240033500
0.1339			52.00	20.00	9002240034000
0.1378			52.00	20.00	9002240035000
0.1406	9/64	28	52.00	20.00	9002240035700
0.1417			52.00	20.00	9002240036000
0.1457			52.00	20.00	9002240037000
0.1496		25	55.00	22.00	9002240038000
0.1516			55.00	22.00	9002240038500
0.1535			55.00	22.00	9002240039000
0.1563	5/32		55.00	22.00	9002240039700
0.1575			55.00	22.00	9002240040000
0.1614			55.00	22.00	9002240041000
0.1654			55.00	22.00	9002240042000
0.1693		18	58.00	24.00	9002240043000
0.1720	11/64		58.00	24.00	9002240043700
0.1732			58.00	24.00	9002240044000
0.1772		16	58.00	24.00	9002240045000
0.1811			58.00	24.00	9002240046000
0.1850		13	58.00	24.00	9002240047000

Dec. inch	Diameter (d1)		l1 mm	l2 mm	EDP #
	Fract. inch	Wire / letter			
0.1874	3/16		62.00	26.00	9002240047600
0.1890		12	62.00	26.00	9002240048000
0.1929			4.900	62.00	9002240049000
0.1969			5.000	62.00	9002240050000
0.2008			5.100	62.00	9002240051000
0.2031	13/64		5.160	62.00	9002240051600
0.2047			5.200	62.00	9002240052000
0.2087			5.300	62.00	9002240053000
0.2126			5.400	66.00	9002240054000
0.2165			5.500	66.00	9002240055000
0.2189	7/32		5.560	66.00	9002240055600
0.2205			5.600	66.00	9002240056000
0.2244			5.700	66.00	9002240057000
0.2283			5.800	66.00	9002240058000
0.2323			5.900	66.00	9002240059000
0.2343	15/64		5.950	66.00	9002240059500
0.2362			6.000	66.00	9002240060000
0.2441			6.200	70.00	9002240062000
0.2480			6.300	70.00	9002240063000
0.2500	1/4	E	6.350	70.00	9002240063500
0.2520			6.400	70.00	9002240064000
0.2559			6.500	70.00	9002240065000
0.2598			6.600	70.00	9002240066000
0.2657	17/64	H	6.750	74.00	9002240067500
0.2677			6.800	74.00	9002240068000
0.2756			7.000	74.00	9002240070000
0.2811	9/32	K	7.140	74.00	9002240071400
0.2854			7.250	74.00	9002240072500
0.2953			7.500	74.00	9002240075000
0.3126	5/16		7.940	79.00	9002240079400
0.3150			8.000	79.00	9002240080000
0.3161		O	8.030	79.00	9002240080300
0.3189			8.100	79.00	9002240081000
0.3280	21/64		8.330	79.00	9002240083300
0.3346			8.500	79.00	9002240085000
0.3543			9.000	84.00	9002240090000
0.3740			9.500	84.00	9002240095000
0.3748	3/8		9.520	89.00	9002240095200
0.3858		W	9.800	89.00	9002240098000
0.3906	25/64		9.920	89.00	9002240099200
0.3937			10.000	89.00	9002240100000
0.4016			10.200	89.00	9002240102000
0.4063	13/32		10.320	89.00	9002240103200
0.4134			10.500	89.00	9002240105000
0.4220	27/64		10.720	95.00	9002240107200
0.4331			11.000	95.00	9002240110000
0.4374	7/16		11.110	95.00	9002240111100
0.4528			11.500	95.00	9002240115000
0.4689	15/32		11.910	102.00	9002240119100
0.4724			12.000	102.00	9002240120000
0.4843	31/64		12.300	102.00	9002240123000
0.4921			12.500	102.00	9002240125000
0.5000	1/2		12.700	102.00	9002240127000
0.5118			13.000	102.00	9002240130000
0.5315			13.500	107.00	9002240135000

Series 224

Speeds & Feeds information pg 427

Dec. inch	Diameter (d1)		mm	l1 mm	l2 mm	EDP #
	Fract. inch	Wire / letter				
0.5512			14.000	107.00	54.00	9002240140000
0.5906			15.000	111.00	56.00	9002240150000
0.6299			16.000	115.00	58.00	9002240160000
0.6693			17.000	119.00	60.00	9002240170000
0.7087			18.000	123.00	62.00	9002240180000
0.7480			19.000	127.00	64.00	9002240190000

Dec. inch	Diameter (d1)		mm	l1 mm	l2 mm	EDP #
	Fract. inch	Wire / letter				
0.7874			20.000	131.00	66.00	9002240200000
0.8268			21.000	136.00	68.00	9002240210000
0.8661			22.000	141.00	70.00	9002240220000

Alternative Drill Series:

#206 HSS, Low Helix, 5xD, 118 pt, Bright
 #223 HSS, GP, 3xD, 118 pt, Oxide

*Items listed in red are non-stocked items, and may take 2 - 6 weeks to receive

3xD



Speeds & Feeds
information pg 428

Series 225



High Helix

HSS, High Helix (Type W), stub length, 130° point, Form A web thinned >14.0mm dia., standard straight shank, RH helix

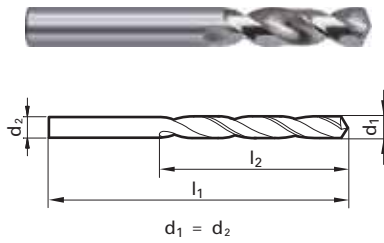
Cut / Shank Dia. = h8 tolerance range



Application Materials:

-  General Steels/Brass
-  Aluminum & Alloys

Diameter (d1)			mm	l1 mm	l2 mm	EDP #
Dec. inch	Fract. inch	Wire / letter				
0.0394			1.000	26.00	6.00	9002250010000
0.0433			1.100	28.00	7.00	9002250011000
0.0469	3/64		1.190	28.00	7.00	9002250011900
0.0472			1.200	28.00	7.00	9002250012000
0.0512			1.300	28.00	7.00	9002250013000
0.0551		54	1.400	32.00	9.00	9002250014000
0.0591			1.500	32.00	9.00	9002250015000
0.0626	1/16		1.590	34.00	10.00	9002250015900
0.0630			1.600	34.00	10.00	9002250016000
0.0669		51	1.700	34.00	10.00	9002250017000
0.0709			1.800	36.00	11.00	9002250018000
0.0748			1.900	36.00	11.00	9002250019000
0.0780	5/64		1.980	38.00	12.00	9002250019800
0.0787			2.000	38.00	12.00	9002250020000
0.0827			2.100	38.00	12.00	9002250021000
0.0866			2.200	40.00	13.00	9002250022000
0.0886			2.250	40.00	13.00	9002250022500
0.0906			2.300	40.00	13.00	9002250023000
0.0937	3/32		2.380	43.00	14.00	9002250023800
0.0945			2.400	43.00	14.00	9002250024000
0.0984			2.500	43.00	14.00	9002250025000
0.1024			2.600	43.00	14.00	9002250026000
0.1063			2.700	46.00	16.00	9002250027000
0.1067		36	2.710	46.00	16.00	9002250027100
0.1083			2.750	46.00	16.00	9002250027500
0.1094	7/64		2.780	46.00	16.00	9002250027800
0.1102			2.800	46.00	16.00	9002250028000
0.1142			2.900	46.00	16.00	9002250029000
0.1181			3.000	46.00	16.00	9002250030000
0.1201		31	3.050	49.00	18.00	9002250030500
0.1220			3.100	49.00	18.00	9002250031000
0.1248	1/8		3.170	49.00	18.00	9002250031700
0.1260			3.200	49.00	18.00	9002250032000
0.1299			3.300	49.00	18.00	9002250033000
0.1339			3.400	52.00	20.00	9002250034000
0.1378			3.500	52.00	20.00	9002250035000
0.1417			3.600	52.00	20.00	9002250036000
0.1457			3.700	52.00	20.00	9002250037000
0.1496		25	3.800	55.00	22.00	9002250038000
0.1535			3.900	55.00	22.00	9002250039000
0.1563	5/32		3.970	55.00	22.00	9002250039700
0.1575			4.000	55.00	22.00	9002250040000
0.1614			4.100	55.00	22.00	9002250041000
0.1654			4.200	55.00	22.00	9002250042000
0.1693		18	4.300	58.00	24.00	9002250043000
0.1720	11/64		4.370	58.00	24.00	9002250043700
0.1732			4.400	58.00	24.00	9002250044000
0.1772		16	4.500	58.00	24.00	9002250045000
0.1811			4.600	58.00	24.00	9002250046000
0.1850		13	4.700	58.00	24.00	9002250047000
0.1874	3/16		4.760	62.00	26.00	9002250047600
0.1890		12	4.800	62.00	26.00	9002250048000
0.1929			4.900	62.00	26.00	9002250049000
0.1969			5.000	62.00	26.00	9002250050000

Diameter (d1)			mm	l1 mm	l2 mm	EDP #
Dec. inch	Fract. inch	Wire / letter				
0.2008			5.100	62.00	26.00	9002250051000
0.2031	13/64		5.160	62.00	26.00	9002250051600
0.2047			5.200	62.00	26.00	9002250052000
0.2067			5.250	62.00	26.00	9002250052500
0.2087			5.300	62.00	26.00	9002250053000
0.2126			5.400	66.00	28.00	9002250054000
0.2165			5.500	66.00	28.00	9002250055000
0.2189	7/32		5.560	66.00	28.00	9002250055600
0.2205			5.600	66.00	28.00	9002250056000
0.2244			5.700	66.00	28.00	9002250057000
0.2283			5.800	66.00	28.00	9002250058000
0.2323			5.900	66.00	28.00	9002250059000
0.2343	15/64		5.950	66.00	28.00	9002250059500
0.2362			6.000	66.00	28.00	9002250060000
0.2402			6.100	70.00	31.00	9002250061000
0.2441			6.200	70.00	31.00	9002250062000
0.2480			6.300	70.00	31.00	9002250063000
0.2500	1/4	E	6.350	70.00	31.00	9002250063500
0.2520			6.400	70.00	31.00	9002250064000
0.2559			6.500	70.00	31.00	9002250065000
0.2571		F	6.530	70.00	31.00	9002250065300
0.2598			6.600	70.00	31.00	9002250066000
0.2657	17/64	H	6.750	74.00	34.00	9002250067500
0.2677			6.800	74.00	34.00	9002250068000
0.2717		I	6.900	74.00	34.00	9002250069000
0.2756			7.000	74.00	34.00	9002250070000
0.2795			7.100	74.00	34.00	9002250071000
0.2811	9/32	K	7.140	74.00	34.00	9002250071400
0.2874			7.300	74.00	34.00	9002250073000
0.2953			7.500	74.00	34.00	9002250075000
0.2992			7.600	79.00	37.00	9002250076000
0.3071			7.800	79.00	37.00	9002250078000
0.3126	5/16		7.940	79.00	37.00	9002250079400
0.3150			8.000	79.00	37.00	9002250080000
0.3189			8.100	79.00	37.00	9002250081000
0.3228		P	8.200	79.00	37.00	9002250082000
0.3268			8.300	79.00	37.00	9002250083000
0.3280	21/64		8.330	79.00	37.00	9002250083300
0.3307			8.400	79.00	37.00	9002250084000
0.3346			8.500	79.00	37.00	9002250085000
0.3386			8.600	84.00	40.00	9002250086000
0.3425			8.700	84.00	40.00	9002250087000
0.3543			9.000	84.00	40.00	9002250090000
0.3701			9.400	84.00	40.00	9002250094000
0.3740			9.500	84.00	40.00	9002250095000
0.3748	3/8		9.520	89.00	43.00	9002250095200
0.3858		W	9.800	89.00	43.00	9002250098000
0.3937			10.000	89.00	43.00	9002250100000
0.4016			10.200	89.00	43.00	9002250102000
0.4134			10.500	89.00	43.00	9002250105000
0.4331			11.000	95.00	47.00	9002250110000
0.4374	7/16		11.110	95.00	47.00	9002250111100
0.4528			11.500	95.00	47.00	9002250115000
0.4646			11.800	95.00	47.00	9002250118000

Series 225

Speeds & Feeds information pg 428

Dec. inch	Diameter (d1)		I1 mm	I2 mm	EDP #	
	Fract. inch	Wire / letter				
0.4689	15/32		11.910	102.00	51.00	9002250119100
0.4724			12.000	102.00	51.00	9002250120000
0.4921			12.500	102.00	51.00	9002250125000
0.5000	1/2		12.700	102.00	51.00	9002250127000
0.5039			12.800	102.00	51.00	9002250128000
0.5118			13.000	102.00	51.00	9002250130000
0.5512			14.000	107.00	54.00	9002250140000
0.5709			14.500	111.00	56.00	9002250145000
0.5906			15.000	111.00	56.00	9002250150000
0.6299			16.000	115.00	58.00	9002250160000
0.6693			17.000	119.00	60.00	9002250170000

Dec. inch	Diameter (d1)		I1 mm	I2 mm	EDP #	
	Fract. inch	Wire / letter				
0.6890			17.500	123.00	62.00	9002250175000
0.7087			18.000	123.00	62.00	9002250180000
0.7480			19.000	127.00	64.00	9002250190000
0.7874			20.000	131.00	66.00	9002250200000

Alternative Drill Series:					
#552 HSS, GT80, 3xD, 130 pt, Bright/nitrided lands > 2.36					
#5521 PM Cobalt, GT500, 3xD, 130 pt, TiN					
#515 PM Cobalt, GT500, 3xD, 130 pt, FIREX®					
#5524 Cobalt, GU500, 3xD, 118 pt, Bright					

*Items listed in red are non-stocked items, and may take 2 - 6 weeks to receive

3xD



Steam Oxide
>6.0 mm dia.



External Coolant



Straight Shank

Speeds & Feeds
information pg 428

Series 226

General Purpose, LH helix

HSS, general purpose (Type N), stub length, 118° point, Form A web thinned
>14.0mm dia., standard straight shank, LH cut

Cut / Shank Dia. = h8 tolerance range

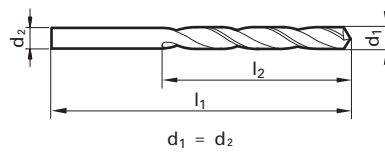

Application Materials:

-  General Steels/Brass
-  Universal Steels
-  Cast Iron

Diameter (d1)		Wire / letter	mm	l1 mm	l2 mm	EDP #
Dec. inch	Fract. inch					
0.0197			0.500	20.00	3.00	9002260005000
0.0217			0.550	21.00	3.50	9002260005500
0.0236			0.600	21.00	3.50	9002260006000
0.0256			0.650	22.00	4.00	9002260006500
0.0276			0.700	23.00	4.50	9002260007000
0.0295			0.750	23.00	4.50	9002260007500
0.0315			0.800	24.00	5.00	9002260008000
0.0335			0.850	24.00	5.00	9002260008500
0.0354			0.900	25.00	5.50	9002260009000
0.0374			0.950	25.00	5.50	9002260009500
0.0394			1.000	26.00	6.00	9002260010000
0.0402		60	1.020	26.00	6.00	9002260010200
0.0413			1.050	26.00	6.00	9002260010500
0.0421		58	1.070	28.00	7.00	9002260010700
0.0429		57	1.090	28.00	7.00	9002260010900
0.0433			1.100	28.00	7.00	9002260011000
0.0453			1.150	28.00	7.00	9002260011500
0.0465		56	1.180	28.00	7.00	9002260011800
0.0469		3/64	1.190	28.00	7.00	9002260011900
0.0472			1.200	28.00	7.00	9002260012000
0.0492			1.250	28.00	7.00	9002260012500
0.0512			1.300	28.00	7.00	9002260013000
0.0520		55	1.320	28.00	7.00	9002260013200
0.0524			1.330	32.00	9.00	9002260013300
0.0531			1.350	32.00	9.00	9002260013500
0.0551		54	1.400	32.00	9.00	9002260014000
0.0571			1.450	32.00	9.00	9002260014500
0.0591			1.500	32.00	9.00	9002260015000
0.0594		53	1.510	34.00	10.00	9002260015100
0.0610			1.550	34.00	10.00	9002260015500
0.0626		1/16	1.590	34.00	10.00	9002260015900
0.0630			1.600	34.00	10.00	9002260016000
0.0634		52	1.610	34.00	10.00	9002260016100
0.0650			1.650	34.00	10.00	9002260016500
0.0669		51	1.700	34.00	10.00	9002260017000
0.0689			1.750	36.00	11.00	9002260017500
0.0701		50	1.780	36.00	11.00	9002260017800
0.0709			1.800	36.00	11.00	9002260018000
0.0713			1.810	36.00	11.00	9002260018100
0.0728		49	1.850	36.00	11.00	9002260018500
0.0748			1.900	36.00	11.00	9002260019000
0.0760		48	1.930	38.00	12.00	9002260019300
0.0768			1.950	38.00	12.00	9002260019500
0.0783		47	1.990	38.00	12.00	9002260019900
0.0787			2.000	38.00	12.00	9002260020000
0.0807			2.050	38.00	12.00	9002260020500
0.0811		46	2.060	38.00	12.00	9002260020600
0.0819		45	2.080	38.00	12.00	9002260020800
0.0827			2.100	38.00	12.00	9002260021000
0.0846			2.150	40.00	13.00	9002260021500
0.0858		44	2.180	40.00	13.00	9002260021800
0.0866			2.200	40.00	13.00	9002260022000
0.0886			2.250	40.00	13.00	9002260022500
0.0890		43	2.260	40.00	13.00	9002260022600
0.0906			2.300	40.00	13.00	9002260023000

Diameter (d1)		Wire / letter	mm	l1 mm	l2 mm	EDP #
Dec. inch	Fract. inch					
0.0925			2.350	40.00	13.00	9002260023500
0.0933		42	2.370	43.00	14.00	9002260023700
0.0937		3/32	2.380	43.00	14.00	9002260023800
0.0945			2.400	43.00	14.00	9002260024000
0.0961		41	2.440	43.00	14.00	9002260024400
0.0965			2.450	43.00	14.00	9002260024500
0.0980		40	2.490	43.00	14.00	9002260024900
0.0984			2.500	43.00	14.00	9002260025000
0.0996		39	2.530	43.00	14.00	9002260025300
0.1004			2.550	43.00	14.00	9002260025500
0.1016		38	2.580	43.00	14.00	9002260025800
0.1024			2.600	43.00	14.00	9002260026000
0.1039		37	2.640	43.00	14.00	9002260026400
0.1043			2.650	43.00	14.00	9002260026500
0.1063			2.700	46.00	16.00	9002260027000
0.1067		36	2.710	46.00	16.00	9002260027100
0.1083			2.750	46.00	16.00	9002260027500
0.1094		7/64	2.780	46.00	16.00	9002260027800
0.1098		35	2.790	46.00	16.00	9002260027900
0.1102			2.800	46.00	16.00	9002260028000
0.1110		34	2.820	46.00	16.00	9002260028200
0.1122			2.850	46.00	16.00	9002260028500
0.1130		33	2.870	46.00	16.00	9002260028700
0.1142			2.900	46.00	16.00	9002260029000
0.1161		32	2.950	46.00	16.00	9002260029500
0.1181			3.000	46.00	16.00	9002260030000
0.1201		31	3.050	49.00	18.00	9002260030500
0.1220			3.100	49.00	18.00	9002260031000
0.1240			3.150	49.00	18.00	9002260031500
0.1248		1/8	3.170	49.00	18.00	9002260031700
0.1260			3.200	49.00	18.00	9002260032000
0.1272			3.230	49.00	18.00	9002260032300
0.1280			3.250	49.00	18.00	9002260032500
0.1283		30	3.260	49.00	18.00	9002260032600
0.1299			3.300	49.00	18.00	9002260033000
0.1319			3.350	49.00	18.00	9002260033500
0.1339			3.400	52.00	20.00	9002260034000
0.1358		29	3.450	52.00	20.00	9002260034500
0.1378			3.500	52.00	20.00	9002260035000
0.1398			3.550	52.00	20.00	9002260035500
0.1417			3.600	52.00	20.00	9002260036000
0.1457			3.700	52.00	20.00	9002260037000
0.1469		26	3.730	52.00	20.00	9002260037300
0.1476			3.750	52.00	20.00	9002260037500
0.1484			3.770	55.00	22.00	9002260037700
0.1496		25	3.800	55.00	22.00	9002260038000
0.1512			3.840	55.00	22.00	9002260038400
0.1516			3.850	55.00	22.00	9002260038500
0.1520		24	3.860	55.00	22.00	9002260038600
0.1535			3.900	55.00	22.00	9002260039000
0.1539		23	3.910	55.00	22.00	9002260039100
0.1555			3.950	55.00	22.00	9002260039500
0.1563		5/32	3.970	55.00	22.00	9002260039700
0.1571		22	3.990	55.00	22.00	9002260039900
0.1575			4.000	55.00	22.00	9002260040000

Series 226

Speeds & Feeds information pg 428

Twist Drills

Dec. inch	Diameter (d1)		l1 mm	l2 mm	EDP #	
	Fract. inch	Wire / letter				
0.1591		21	4.040	55.00	22.00	9002260040400
0.1594			4.050	55.00	22.00	9002260040500
0.1614			4.100	55.00	22.00	9002260041000
0.1634			4.150	55.00	22.00	9002260041500
0.1654			4.200	55.00	22.00	9002260042000
0.1661		19	4.220	55.00	22.00	9002260042200
0.1673			4.250	55.00	22.00	9002260042500
0.1693		18	4.300	58.00	24.00	9002260043000
0.1713			4.350	58.00	24.00	9002260043500
0.1720	11/64		4.370	58.00	24.00	9002260043700
0.1728		17	4.390	58.00	24.00	9002260043900
0.1732			4.400	58.00	24.00	9002260044000
0.1752			4.450	58.00	24.00	9002260044500
0.1772		16	4.500	58.00	24.00	9002260045000
0.1799		15	4.570	58.00	24.00	9002260045700
0.1811			4.600	58.00	24.00	9002260046000
0.1850		13	4.700	58.00	24.00	9002260047000
0.1870			4.750	58.00	24.00	9002260047500
0.1874	3/16		4.760	62.00	26.00	9002260047600
0.1890		12	4.800	62.00	26.00	9002260048000
0.1909		11	4.850	62.00	26.00	9002260048500
0.1929			4.900	62.00	26.00	9002260049000
0.1937		10	4.920	62.00	26.00	9002260049200
0.1961		9	4.980	62.00	26.00	9002260049800
0.1969			5.000	62.00	26.00	9002260050000
0.1988			5.050	62.00	26.00	9002260050500
0.2008			5.100	62.00	26.00	9002260051000
0.2012		7	5.110	62.00	26.00	9002260051100
0.2028			5.150	62.00	26.00	9002260051500
0.2031	13/64		5.160	62.00	26.00	9002260051600
0.2039		6	5.180	62.00	26.00	9002260051800
0.2047			5.200	62.00	26.00	9002260052000
0.2055		5	5.220	62.00	26.00	9002260052200
0.2067			5.250	62.00	26.00	9002260052500
0.2087			5.300	62.00	26.00	9002260053000
0.2091		4	5.310	66.00	28.00	9002260053100
0.2106			5.350	66.00	28.00	9002260053500
0.2126			5.400	66.00	28.00	9002260054000
0.2130		3	5.410	66.00	28.00	9002260054100
0.2165			5.500	66.00	28.00	9002260055000
0.2189	7/32		5.560	66.00	28.00	9002260055600
0.2205			5.600	66.00	28.00	9002260056000
0.2209		2	5.610	66.00	28.00	9002260056100
0.2224			5.650	66.00	28.00	9002260056500
0.2244			5.700	66.00	28.00	9002260057000
0.2264			5.750	66.00	28.00	9002260057500
0.2280		1	5.790	66.00	28.00	9002260057900
0.2283			5.800	66.00	28.00	9002260058000
0.2323			5.900	66.00	28.00	9002260059000
0.2343	15/64		5.950	66.00	28.00	9002260059500
0.2362			6.000	66.00	28.00	9002260060000
0.2378		B	6.040	70.00	31.00	9002260060400
0.2402			6.100	70.00	31.00	9002260061000
0.2421		C	6.150	70.00	31.00	9002260061500
0.2441			6.200	70.00	31.00	9002260062000
0.2461		D	6.250	70.00	31.00	9002260062500
0.2480			6.300	70.00	31.00	9002260063000
0.2500	1/4	E	6.350	70.00	31.00	9002260063500
0.2520			6.400	70.00	31.00	9002260064000
0.2559			6.500	70.00	31.00	9002260065000
0.2571		F	6.530	70.00	31.00	9002260065300
0.2598			6.600	70.00	31.00	9002260066000
0.2610		G	6.630	70.00	31.00	9002260066300
0.2638			6.700	70.00	31.00	9002260067000
0.2657	17/64	H	6.750	74.00	34.00	9002260067500
0.2677			6.800	74.00	34.00	9002260068000
0.2717		I	6.900	74.00	34.00	9002260069000
0.2736			6.950	74.00	34.00	9002260069500
0.2756			7.000	74.00	34.00	9002260070000
0.2795			7.100	74.00	34.00	9002260071000
0.2811	9/32	K	7.140	74.00	34.00	9002260071400

Dec. inch	Diameter (d1)		l1 mm	l2 mm	EDP #	
	Fract. inch	Wire / letter				
0.2835			7.200	74.00	34.00	9002260072000
0.2854			7.250	74.00	34.00	9002260072500
0.2874			7.300	74.00	34.00	9002260073000
0.2902		L	7.370	74.00	34.00	9002260073700
0.2913			7.400	74.00	34.00	9002260074000
0.2949		M	7.490	74.00	34.00	9002260074900
0.2953			7.500	74.00	34.00	9002260075000
0.2969	19/64		7.540	79.00	37.00	9002260075400
0.2992			7.600	79.00	37.00	9002260076000
0.3031			7.700	79.00	37.00	9002260077000
0.3051			7.750	79.00	37.00	9002260077500
0.3071			7.800	79.00	37.00	9002260078000
0.3110			7.900	79.00	37.00	9002260079000
0.3126	5/16		7.940	79.00	37.00	9002260079400
0.3150			8.000	79.00	37.00	9002260080000
0.3161		O	8.030	79.00	37.00	9002260080300
0.3189			8.100	79.00	37.00	9002260081000
0.3228		P	8.200	79.00	37.00	9002260082000
0.3268			8.300	79.00	37.00	9002260083000
0.3307			8.400	79.00	37.00	9002260084000
0.3319		Q	8.430	79.00	37.00	9002260084300
0.3346			8.500	79.00	37.00	9002260085000
0.3386			8.600	84.00	40.00	9002260086000
0.3425			8.700	84.00	40.00	9002260087000
0.3437	11/32		8.730	84.00	40.00	9002260087300
0.3445			8.750	84.00	40.00	9002260087500
0.3465			8.800	84.00	40.00	9002260088000
0.3480		S	8.840	84.00	40.00	9002260088400
0.3504			8.900	84.00	40.00	9002260089000
0.3543			9.000	84.00	40.00	9002260090000
0.3579		T	9.090	84.00	40.00	9002260090900
0.3583			9.100	84.00	40.00	9002260091000
0.3594	23/64		9.130	84.00	40.00	9002260091300
0.3622			9.200	84.00	40.00	9002260092000
0.3677		U	9.340	84.00	40.00	9002260093400
0.3701			9.400	84.00	40.00	9002260094000
0.3740			9.500	84.00	40.00	9002260095000
0.3748	3/8		9.520	89.00	43.00	9002260095200
0.3780			9.600	89.00	43.00	9002260096000
0.3819			9.700	89.00	43.00	9002260097000
0.3839			9.750	89.00	43.00	9002260097500
0.3858		W	9.800	89.00	43.00	9002260098000
0.3898			9.900	89.00	43.00	9002260099000
0.3937			10.000	89.00	43.00	9002260100000
0.3969		X	10.080	89.00	43.00	9002260100800
0.3976			10.100	89.00	43.00	9002260101000
0.4016			10.200	89.00	43.00	9002260102000
0.4035			10.250	89.00	43.00	9002260102500
0.4055			10.300	89.00	43.00	9002260103000
0.4063	13/32		10.320	89.00	43.00	9002260103200
0.4094			10.400	89.00	43.00	9002260104000
0.4130		Z	10.490	89.00	43.00	9002260104900
0.4134			10.500	89.00	43.00	9002260105000
0.4173			10.600	89.00	43.00	9002260106000
0.4252			10.800	95.00	47.00	9002260108000
0.4291			10.900	95.00	47.00	9002260109000
0.4331			11.000	95.00	47.00	9002260110000
0.4370			11.100	95.00	47.00	9002260111000
0.4374	7/16		11.110	95.00	47.00	9002260111100
0.4409			11.200	95.00	47.00	9002260112000
0.4429			11.250	95.00	47.00	9002260112500
0.4449			11.300	95.00	47.00	9002260113000
0.4488			11.400	95.00	47.00	9002260114000
0.4528			11.500	95.00	47.00	9002260115000
0.4531	29/64		11.510	95.00	47.00	9002260115100
0.4606			11.700	95.00	47.00	9002260117000
0.4626			11.750	95.00	47.00	9002260117500
0.4646			11.800	95.00	47.00	9002260118000
0.4724			12.000	102.00	51.00	9002260120000
0.4764			12.100	102.00	51.00	9002260121000
0.4803			12.200	102.00	51.00	9002260122000

*Items listed in red are non-stocked items, and may take 2 - 6 weeks to receive

Series 226

Speeds & Feeds information pg 428

Dec. inch	Diameter (d1)		l1 mm	l2 mm	EDP #	
	Fract. inch	Wire / letter				
0.4843	31/64		12.300	102.00	51.00	9002260123000
0.4882			12.400	102.00	51.00	9002260124000
0.4921			12.500	102.00	51.00	9002260125000
0.4961			12.600	102.00	51.00	9002260126000
0.5000	1/2		12.700	102.00	51.00	9002260127000
0.5118			13.000	102.00	51.00	9002260130000
0.5354			13.600	107.00	54.00	9002260136000
0.5906			15.000	111.00	56.00	9002260150000
0.5984			15.200	115.00	58.00	9002260152000
0.6181			15.700	115.00	58.00	9002260157000
0.6201			15.750	115.00	58.00	9002260157500
0.6248	5/8		15.870	115.00	58.00	9002260158700
0.6496			16.500	119.00	60.00	9002260165000

Dec. inch	Diameter (d1)		l1 mm	l2 mm	EDP #	
	Fract. inch	Wire / letter				
0.6693			17.000	119.00	60.00	9002260170000
0.7500	3/4		19.050	131.00	66.00	9002260190500
0.7811		25/32		19.840	131.00	66.00
1.0000	1		25.400	156.00	78.00	9002260254000
1.0039				25.500	156.00	78.00
1.2008			30.500	174.00	87.00	9002260305000
1.7500	1 3/4		44.450	214.00	108.00	9002260444500

Alternative Drill Series:
#553 HSS, GT100, LH, 3xD, 130 pt, Bright/nitrided lands > 2.36

Extra Length

#1



Steam Oxide
>2.36 mm dia.



External Coolant

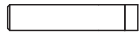

Straight Shank

Speeds & Feeds
information pg 429

Series 235

General Purpose

HSS, general purpose (Type N), extra length #1, 118° point, Form A
web thinned >2.36mm dia., standard straight shank, RH helix

Cut / Shank Dia. = h8 tolerance range

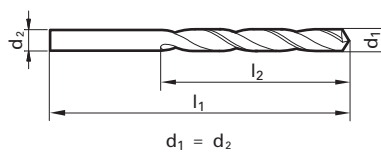

Application Materials:



General Steels/
Brass



Universal Steels



Cast Iron

Twist Drills

Dec. inch	Diameter (d1)			l1 mm	l2 mm	EDP #
	Fract. inch	Wire / letter	mm			
0.0630			1.600	115.00	75.00	9002350016000
0.0709			1.800	120.00	80.00	9002350018000
0.0748			1.900	120.00	80.00	9002350019000
0.0768			1.950	125.00	85.00	9002350019500
0.0787			2.000	125.00	85.00	9002350020000
0.0807			2.050	125.00	85.00	9002350020500
0.0827			2.100	125.00	85.00	9002350021000
0.0866			2.200	135.00	90.00	9002350022000
0.0906			2.300	135.00	90.00	9002350023000
0.0937	3/32		2.380	150.00	100.00	9002350023800
0.0945			2.400	150.00	100.00	9002350024000
0.0984			2.500	150.00	100.00	9002350025000
0.1024			2.600	150.00	100.00	9002350026000
0.1063			2.700	150.00	100.00	9002350027000
0.1094	7/64		2.780	150.00	100.00	9002350027800
0.1102			2.800	150.00	100.00	9002350028000
0.1142			2.900	150.00	100.00	9002350029000
0.1181			3.000	150.00	100.00	9002350030000
0.1220			3.100	155.00	105.00	9002350031000
0.1248	1/8		3.170	155.00	105.00	9002350031700
0.1260			3.200	155.00	105.00	9002350032000
0.1280			3.250	155.00	105.00	9002350032500
0.1299			3.300	155.00	105.00	9002350033000
0.1339			3.400	165.00	115.00	9002350034000
0.1378			3.500	165.00	115.00	9002350035000
0.1406	9/64	28	3.570	165.00	115.00	9002350035700
0.1417			3.600	165.00	115.00	9002350036000
0.1457			3.700	165.00	115.00	9002350037000
0.1496		25	3.800	175.00	120.00	9002350038000
0.1535			3.900	175.00	120.00	9002350039000
0.1563	5/32		3.970	175.00	120.00	9002350039700
0.1575			4.000	175.00	120.00	9002350040000
0.1614			4.100	175.00	120.00	9002350041000
0.1654			4.200	175.00	120.00	9002350042000
0.1693		18	4.300	185.00	125.00	9002350043000
0.1720	11/64		4.370	185.00	125.00	9002350043700
0.1732			4.400	185.00	125.00	9002350044000
0.1772		16	4.500	185.00	125.00	9002350045000
0.1811			4.600	185.00	125.00	9002350046000
0.1850		13	4.700	185.00	125.00	9002350047000
0.1874	3/16		4.760	195.00	135.00	9002350047600
0.1890		12	4.800	195.00	135.00	9002350048000
0.1929			4.900	195.00	135.00	9002350049000
0.1969			5.000	195.00	135.00	9002350050000
0.2008			5.100	195.00	135.00	9002350051000
0.2047			5.200	195.00	135.00	9002350052000
0.2087			5.300	195.00	135.00	9002350053000
0.2126			5.400	205.00	140.00	9002350054000
0.2165			5.500	205.00	140.00	9002350055000
0.2189	7/32		5.560	205.00	140.00	9002350055600
0.2205			5.600	205.00	140.00	9002350056000
0.2244			5.700	205.00	140.00	9002350057000
0.2283			5.800	205.00	140.00	9002350058000
0.2323			5.900	205.00	140.00	9002350059000
0.2343	15/64		5.950	205.00	140.00	9002350059500

Dec. inch	Diameter (d1)			l1 mm	l2 mm	EDP #
	Fract. inch	Wire / letter	mm			
0.2362			6.000	205.00	140.00	9002350060000
0.2402			6.100	215.00	150.00	9002350061000
0.2441			6.200	215.00	150.00	9002350062000
0.2480			6.300	215.00	150.00	9002350063000
0.2500	1/4	E	6.350	215.00	150.00	9002350063500
0.2520			6.400	215.00	150.00	9002350064000
0.2559			6.500	215.00	150.00	9002350065000
0.2598			6.600	215.00	150.00	9002350066000
0.2638			6.700	215.00	150.00	9002350067000
0.2657	17/64	H	6.750	225.00	155.00	9002350067500
0.2677			6.800	225.00	155.00	9002350068000
0.2756			7.000	225.00	155.00	9002350070000
0.2795			7.100	225.00	155.00	9002350071000
0.2811	9/32	K	7.140	225.00	155.00	9002350071400
0.2835			7.200	225.00	155.00	9002350072000
0.2913			7.400	225.00	155.00	9002350074000
0.2953			7.500	225.00	155.00	9002350075000
0.2969	19/64		7.540	240.00	165.00	9002350075400
0.2992			7.600	240.00	165.00	9002350076000
0.3031			7.700	240.00	165.00	9002350077000
0.3071			7.800	240.00	165.00	9002350078000
0.3110			7.900	240.00	165.00	9002350079000
0.3126	5/16		7.940	240.00	165.00	9002350079400
0.3150			8.000	240.00	165.00	9002350080000
0.3189			8.100	240.00	165.00	9002350081000
0.3228		P	8.200	240.00	165.00	9002350082000
0.3268			8.300	240.00	165.00	9002350083000
0.3280	21/64		8.330	240.00	165.00	9002350083300
0.3307			8.400	240.00	165.00	9002350084000
0.3346			8.500	240.00	165.00	9002350085000
0.3386			8.600	250.00	175.00	9002350086000
0.3425			8.700	250.00	175.00	9002350087000
0.3437	11/32		8.730	250.00	175.00	9002350087300
0.3465			8.800	250.00	175.00	9002350088000
0.3543			9.000	250.00	175.00	9002350090000
0.3594	23/64		9.130	250.00	175.00	9002350091300
0.3740			9.500	250.00	175.00	9002350095000
0.3748	3/8		9.520	265.00	185.00	9002350095200
0.3780			9.600	265.00	185.00	9002350096000
0.3819			9.700	265.00	185.00	9002350097000
0.3858		W	9.800	265.00	185.00	9002350098000
0.3898			9.900	265.00	185.00	9002350099000
0.3937			10.000	265.00	185.00	9002350100000
0.4063	13/32		10.320	265.00	185.00	9002350103200
0.4134			10.500	265.00	185.00	9002350105000
0.4331			11.000	280.00	195.00	9002350110000
0.4374	7/16		11.110	280.00	195.00	9002350111100
0.4528			11.500	280.00	195.00	9002350115000
0.4724			12.000	295.00	205.00	9002350120000
0.4764			12.100	295.00	205.00	9002350121000
0.4843	31/64		12.300	295.00	205.00	9002350123000
0.4921			12.500	295.00	205.00	9002350125000
0.5000	1/2		12.700	295.00	205.00	9002350127000
0.5118			13.000	295.00	205.00	9002350130000

*Items listed in red are non-stocked items, and may take 2 - 6 weeks to receive

5xD



Steam Oxide



External Coolant



Morse Taper Shank

Speeds & Feeds information pg 429

Series 245

General Purpose

HSS, general purpose (Type N), Standard (MTS), 118° point, Form A web thinned >14.0mm dia. Morse Taper shank, RH helix

Cut / Shank Dia. = h8 tolerance range

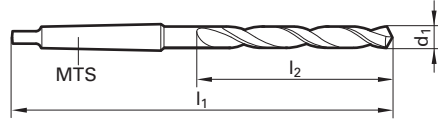

Application Materials:



General Steels/
Brass



Universal Steels



Cast Iron

Diameter (d1)		Wire / letter	Shank size	l1	l2	EDP #
Dec. inch	Fract. inch					
0.0937	3/32		MTS 1	111.00	30.00	9002450023800
0.0984			MTS 1	111.00	30.00	9002450025000
0.1094	7/64		MTS 1	114.00	33.00	9002450027800
0.1248	1/8		MTS 1	117.00	36.00	9002450031700
0.1406	9/64	28	MTS 1	120.00	39.00	9002450035700
0.1496		25	MTS 1	124.00	43.00	9002450038000
0.1563	5/32		MTS 1	124.00	43.00	9002450039700
0.1575			MTS 1	124.00	43.00	9002450040000
0.1673			MTS 1	124.00	43.00	9002450042500
0.1720	11/64		MTS 1	128.00	47.00	9002450043700
0.1772		16	MTS 1	128.00	47.00	9002450045000
0.1874	3/16		MTS 1	133.00	52.00	9002450047600
0.1969			MTS 1	133.00	52.00	9002450050000
0.2008			MTS 1	133.00	52.00	9002450051000
0.2031	13/64		MTS 1	133.00	52.00	9002450051600
0.2047			MTS 1	133.00	52.00	9002450052000
0.2067			MTS 1	133.00	52.00	9002450052500
0.2087			MTS 1	133.00	52.00	9002450053000
0.2126			MTS 1	138.00	57.00	9002450054000
0.2165			MTS 1	138.00	57.00	9002450055000
0.2189	7/32		MTS 1	138.00	57.00	9002450055600
0.2205			MTS 1	138.00	57.00	9002450056000
0.2244			MTS 1	138.00	57.00	9002450057000
0.2264			MTS 1	138.00	57.00	9002450057500
0.2283			MTS 1	138.00	57.00	9002450058000
0.2323			MTS 1	138.00	57.00	9002450059000
0.2343	15/64		MTS 1	138.00	57.00	9002450059500
0.2362			MTS 1	138.00	57.00	9002450060000
0.2402			MTS 1	144.00	63.00	9002450061000
0.2441			MTS 1	144.00	63.00	9002450062000
0.2461		D	MTS 1	144.00	63.00	9002450062500
0.2480			MTS 1	144.00	63.00	9002450063000
0.2500	1/4	E	MTS 1	144.00	63.00	9002450063500
0.2520			MTS 1	144.00	63.00	9002450064000
0.2559			MTS 1	144.00	63.00	9002450065000
0.2598			MTS 1	144.00	63.00	9002450066000
0.2638			MTS 1	144.00	63.00	9002450067000
0.2657	17/64	H	MTS 1	150.00	69.00	9002450067500
0.2677			MTS 1	150.00	69.00	9002450068000
0.2717		I	MTS 1	150.00	69.00	9002450069000
0.2756			MTS 1	150.00	69.00	9002450070000
0.2811	9/32	K	MTS 1	150.00	69.00	9002450071400
0.2835			MTS 1	150.00	69.00	9002450072000
0.2854			MTS 1	150.00	69.00	9002450072500
0.2874			MTS 1	150.00	69.00	9002450073000
0.2913			MTS 1	150.00	69.00	9002450074000
0.2953			MTS 1	150.00	69.00	9002450075000
0.2969	19/64		MTS 1	156.00	75.00	9002450075400
0.2992			MTS 1	156.00	75.00	9002450076000
0.3031			MTS 1	156.00	75.00	9002450077000
0.3051			MTS 1	156.00	75.00	9002450077500
0.3071			MTS 1	156.00	75.00	9002450078000
0.3110			MTS 1	156.00	75.00	9002450079000
0.3126	5/16		MTS 1	156.00	75.00	9002450079400

Diameter (d1)		Wire / letter	Shank size	l1	l2	EDP #
Dec. inch	Fract. inch					
0.3150			MTS 1	156.00	75.00	9002450080000
0.3189			MTS 1	156.00	75.00	9002450081000
0.3228		P	MTS 1	156.00	75.00	9002450082000
0.3248			MTS 1	156.00	75.00	9002450082500
0.3268			MTS 1	156.00	75.00	9002450083000
0.3280	21/64		MTS 1	156.00	75.00	9002450083300
0.3307			MTS 1	156.00	75.00	9002450084000
0.3346			MTS 1	156.00	75.00	9002450085000
0.3386			MTS 1	162.00	81.00	9002450086000
0.3425			MTS 1	162.00	81.00	9002450087000
0.3437	11/32		MTS 1	162.00	81.00	9002450087300
0.3445			MTS 1	162.00	81.00	9002450087500
0.3465			MTS 1	162.00	81.00	9002450088000
0.3504			MTS 1	162.00	81.00	9002450089000
0.3543			MTS 1	162.00	81.00	9002450090000
0.3583			MTS 1	162.00	81.00	9002450091000
0.3594	23/64		MTS 1	162.00	81.00	9002450091300
0.3622			MTS 1	162.00	81.00	9002450092000
0.3642			MTS 1	162.00	81.00	9002450092500
0.3661			MTS 1	162.00	81.00	9002450093000
0.3701			MTS 1	162.00	81.00	9002450094000
0.3740			MTS 1	162.00	81.00	9002450095000
0.3748	3/8		MTS 1	168.00	87.00	9002450095200
0.3819			MTS 1	168.00	87.00	9002450097000
0.3839			MTS 1	168.00	87.00	9002450097500
0.3858		W	MTS 1	168.00	87.00	9002450098000
0.3898			MTS 1	168.00	87.00	9002450099000
0.3906	25/64		MTS 1	168.00	87.00	9002450099200
0.3937			MTS 1	168.00	87.00	9002450100000
0.3976			MTS 1	168.00	87.00	9002450101000
0.4016			MTS 1	168.00	87.00	9002450102000
0.4035			MTS 1	168.00	87.00	9002450102500
0.4055			MTS 1	168.00	87.00	9002450103000
0.4063	13/32		MTS 1	168.00	87.00	9002450103200
0.4094			MTS 1	168.00	87.00	9002450104000
0.4134			MTS 1	168.00	87.00	9002450105000
0.4173			MTS 1	168.00	87.00	9002450106000
0.4213			MTS 1	175.00	94.00	9002450107000
0.4220	27/64		MTS 1	175.00	94.00	9002450107200
0.4232			MTS 1	175.00	94.00	9002450107500
0.4252			MTS 1	175.00	94.00	9002450108000
0.4291			MTS 1	175.00	94.00	9002450109000
0.4331			MTS 1	175.00	94.00	9002450110000
0.4370			MTS 1	175.00	94.00	9002450111000
0.4374	7/16		MTS 1	175.00	94.00	9002450111100
0.4409			MTS 1	175.00	94.00	9002450112000
0.4429			MTS 1	175.00	94.00	9002450112500
0.4449			MTS 1	175.00	94.00	9002450113000
0.4488			MTS 1	175.00	94.00	9002450114000
0.4528			MTS 1	175.00	94.00	9002450115000
0.4531	29/64		MTS 1	175.00	94.00	9002450115100
0.4567			MTS 1	175.00	94.00	9002450116000
0.4606			MTS 1	175.00	94.00	9002450117000
0.4626			MTS 1	175.00	94.00	9002450117500

Series 245

Speeds & Feeds information pg 429

Twist Drills

Diameter (d1)		Shank size	l1 mm	l2 mm	EDP #
Dec. inch	Fract. inch				
0.4646		MTS 1	175.00	94.00	9002450118000
0.4685		MTS 1	182.00	101.00	9002450119000
0.4689	15/32	MTS 1	182.00	101.00	9002450119100
0.4724		MTS 1	182.00	101.00	9002450120000
0.4764		MTS 1	182.00	101.00	9002450121000
0.4803		MTS 1	182.00	101.00	9002450122000
0.4823		MTS 1	182.00	101.00	9002450122500
0.4843	31/64	MTS 1	182.00	101.00	9002450123000
0.4882		MTS 1	182.00	101.00	9002450124000
0.4921		MTS 1	182.00	101.00	9002450125000
0.4961		MTS 1	182.00	101.00	9002450126000
0.5000	1/2	MTS 1	182.00	101.00	9002450127000
0.5020		MTS 1	182.00	101.00	9002450127500
0.5039		MTS 1	182.00	101.00	9002450128000
0.5059		MTS 1	182.00	101.00	9002450128500
0.5079		MTS 1	182.00	101.00	9002450129000
0.5118		MTS 1	182.00	101.00	9002450130000
0.5157	33/64	MTS 1	182.00	101.00	9002450131000
0.5197		MTS 1	182.00	101.00	9002450132000
0.5217		MTS 1	189.00	108.00	9002450132500
0.5236		MTS 1	189.00	108.00	9002450133000
0.5276		MTS 1	189.00	108.00	9002450134000
0.5311	17/32	MTS 1	189.00	108.00	9002450134900
0.5315		MTS 1	189.00	108.00	9002450135000
0.5354		MTS 1	189.00	108.00	9002450136000
0.5394		MTS 1	189.00	108.00	9002450137000
0.5413		MTS 1	189.00	108.00	9002450137500
0.5433		MTS 1	189.00	108.00	9002450138000
0.5469	35/64	MTS 1	189.00	108.00	9002450138900
0.5472		MTS 1	189.00	108.00	9002450139000
0.5512		MTS 1	189.00	108.00	9002450140000
0.5551		MTS 2	212.00	114.00	9002450141000
0.5591		MTS 2	212.00	114.00	9002450142000
0.5610		MTS 2	212.00	114.00	9002450142500
0.5626	9/16	MTS 2	212.00	114.00	9002450142900
0.5630		MTS 2	212.00	114.00	9002450143000
0.5669		MTS 2	212.00	114.00	9002450144000
0.5709		MTS 2	212.00	114.00	9002450145000
0.5748		MTS 2	212.00	114.00	9002450146000
0.5780	37/64	MTS 2	212.00	114.00	9002450146800
0.5787		MTS 2	212.00	114.00	9002450147000
0.5807		MTS 2	212.00	114.00	9002450147500
0.5827		MTS 2	212.00	114.00	9002450148000
0.5866		MTS 2	212.00	114.00	9002450149000
0.5906		MTS 2	212.00	114.00	9002450150000
0.5937	19/32	MTS 2	218.00	120.00	9002450150800
0.5945		MTS 2	218.00	120.00	9002450151000
0.5984		MTS 2	218.00	120.00	9002450152000
0.6004		MTS 2	218.00	120.00	9002450152500
0.6024		MTS 2	218.00	120.00	9002450153000
0.6063		MTS 2	218.00	120.00	9002450154000
0.6094	39/64	MTS 2	218.00	120.00	9002450154800
0.6102		MTS 2	218.00	120.00	9002450155000
0.6142		MTS 2	218.00	120.00	9002450156000
0.6181		MTS 2	218.00	120.00	9002450157000
0.6201		MTS 2	218.00	120.00	9002450157500
0.6220		MTS 2	218.00	120.00	9002450158000
0.6248	5/8	MTS 2	218.00	120.00	9002450158700
0.6260		MTS 2	218.00	120.00	9002450159000
0.6299		MTS 2	218.00	120.00	9002450160000
0.6319		MTS 2	218.00	120.00	9002450160500
0.6339		MTS 2	223.00	125.00	9002450161000
0.6378		MTS 2	223.00	125.00	9002450162000
0.6398		MTS 2	223.00	125.00	9002450162500
0.6406	41/64	MTS 2	223.00	125.00	9002450162700
0.6417		MTS 2	223.00	125.00	9002450163000
0.6457		MTS 2	223.00	125.00	9002450164000

Diameter (d1)		Shank size	l1 mm	l2 mm	EDP #
Dec. inch	Fract. inch				
0.6496		MTS 2	223.00	125.00	9002450165000
0.6535		MTS 2	223.00	125.00	9002450166000
0.6563	21/32	MTS 2	223.00	125.00	9002450166700
0.6575		MTS 2	223.00	125.00	9002450167000
0.6594		MTS 2	223.00	125.00	9002450167500
0.6614		MTS 2	223.00	125.00	9002450168000
0.6654		MTS 2	223.00	125.00	9002450169000
0.6693		MTS 2	223.00	125.00	9002450170000
0.6720	43/64	MTS 2	228.00	130.00	9002450170700
0.6732		MTS 2	228.00	130.00	9002450171000
0.6772		MTS 2	228.00	130.00	9002450172000
0.6791		MTS 2	228.00	130.00	9002450172500
0.6811		MTS 2	228.00	130.00	9002450173000
0.6850		MTS 2	228.00	130.00	9002450174000
0.6874	11/16	MTS 2	228.00	130.00	9002450174600
0.6890		MTS 2	228.00	130.00	9002450175000
0.6929		MTS 2	228.00	130.00	9002450176000
0.6969		MTS 2	228.00	130.00	9002450177000
0.6988		MTS 2	228.00	130.00	9002450177500
0.7008		MTS 2	228.00	130.00	9002450178000
0.7031	45/64	MTS 2	228.00	130.00	9002450178600
0.7047		MTS 2	228.00	130.00	9002450179000
0.7087		MTS 2	228.00	130.00	9002450180000
0.7126		MTS 2	233.00	135.00	9002450181000
0.7165		MTS 2	233.00	135.00	9002450182000
0.7185		MTS 2	233.00	135.00	9002450182500
0.7189	23/32	MTS 2	233.00	135.00	9002450182600
0.7205		MTS 2	233.00	135.00	9002450183000
0.7283		MTS 2	233.00	135.00	9002450185000
0.7323		MTS 2	233.00	135.00	9002450186000
0.7343	47/64	MTS 2	233.00	135.00	9002450186500
0.7382		MTS 2	233.00	135.00	9002450187500
0.7402		MTS 2	233.00	135.00	9002450188000
0.7441		MTS 2	233.00	135.00	9002450189000
0.7480		MTS 2	233.00	135.00	9002450190000
0.7500	3/4	MTS 2	238.00	140.00	9002450190500
0.7520		MTS 2	238.00	140.00	9002450191000
0.7559		MTS 2	238.00	140.00	9002450192000
0.7579		MTS 2	238.00	140.00	9002450192500
0.7657	49/64	MTS 2	238.00	140.00	9002450194500
0.7677		MTS 2	238.00	140.00	9002450195000
0.7717		MTS 2	238.00	140.00	9002450196000
0.7756		MTS 2	238.00	140.00	9002450197000
0.7776		MTS 2	238.00	140.00	9002450197500
0.7795		MTS 2	238.00	140.00	9002450198000
0.7811	25/32	MTS 2	238.00	140.00	9002450198400
0.7835		MTS 2	238.00	140.00	9002450199000
0.7874		MTS 2	238.00	140.00	9002450200000
0.7913		MTS 2	243.00	145.00	9002450201000
0.7953		MTS 2	243.00	145.00	9002450202000
0.7969	51/64	MTS 2	243.00	145.00	9002450202400
0.7972		MTS 2	243.00	145.00	9002450202500
0.7992		MTS 2	243.00	145.00	9002450203000
0.8031		MTS 2	243.00	145.00	9002450204000
0.8071		MTS 2	243.00	145.00	9002450205000
0.8110		MTS 2	243.00	145.00	9002450206000
0.8126	13/16	MTS 2	243.00	145.00	9002450206400
0.8150		MTS 2	243.00	145.00	9002450207000
0.8169		MTS 2	243.00	145.00	9002450207500
0.8189		MTS 2	243.00	145.00	9002450208000
0.8268		MTS 2	243.00	145.00	9002450210000
0.8280	53/64	MTS 2	243.00	145.00	9002450210300
0.8307		MTS 2	243.00	145.00	9002450211000
0.8346		MTS 2	243.00	145.00	9002450212000
0.8366		MTS 2	248.00	150.00	9002450212500
0.8425		MTS 2	248.00	150.00	9002450214000
0.8437	27/32	MTS 2	248.00	150.00	9002450214300

*Items listed in red are non-stocked items, and may take 2 - 6 weeks to receive

Series 245

Speeds & Feeds information pg 429

Twist Drills

Dec. inch	Diameter (d1)		Shank size	l1 mm	l2 mm	EDP #
	Fract. inch	Wire / letter				
0.8465			MTS 2	248.00	150.00	9002450215000
0.8543			MTS 2	248.00	150.00	9002450217000
0.8563			MTS 2	248.00	150.00	9002450217500
0.8594	5/64		MTS 2	248.00	150.00	9002450218300
0.8661			MTS 2	248.00	150.00	9002450220000
0.8701			MTS 2	248.00	150.00	9002450221000
0.8740			MTS 2	248.00	150.00	9002450222000
0.8748	7/8		MTS 2	248.00	150.00	9002450222200
0.8760			MTS 2	248.00	150.00	9002450222500
0.8780			MTS 2	248.00	150.00	9002450223000
0.8819			MTS 2	248.00	150.00	9002450224000
0.8858			MTS 2	253.00	155.00	9002450225000
0.8906	57/64		MTS 2	253.00	155.00	9002450226200
0.8957			MTS 2	253.00	155.00	9002450227500
0.9055			MTS 2	253.00	155.00	9002450230000
0.9063	29/32		MTS 2	253.00	155.00	9002450230200
0.9154			MTS 3	276.00	155.00	9002450232500
0.9220	59/64		MTS 3	276.00	155.00	9002450234200
0.9252			MTS 3	276.00	155.00	9002450235000
0.9350			MTS 3	281.00	160.00	9002450237500
0.9374	15/16		MTS 3	281.00	160.00	9002450238100
0.9449			MTS 3	281.00	160.00	9002450240000
0.9531	61/64		MTS 3	281.00	160.00	9002450242100
0.9547			MTS 3	281.00	160.00	9002450242500
0.9567			MTS 3	281.00	160.00	9002450243000
0.9646			MTS 3	281.00	160.00	9002450245000
0.9689	31/32		MTS 3	281.00	160.00	9002450246100
0.9744			MTS 3	281.00	160.00	9002450247500
0.9843	63/64		MTS 3	281.00	160.00	9002450250000
0.9941			MTS 3	286.00	165.00	9002450252500
1.0000	1		MTS 3	286.00	165.00	9002450254000
1.0039			MTS 3	286.00	165.00	9002450255000
1.0138			MTS 3	286.00	165.00	9002450257500
1.0157	1 1/64		MTS 3	286.00	165.00	9002450258000
1.0236			MTS 3	286.00	165.00	9002450260000
1.0311	1 1/32		MTS 3	286.00	165.00	9002450261900
1.0335			MTS 3	286.00	165.00	9002450262500
1.0433			MTS 3	286.00	165.00	9002450265000
1.0469	1 3/64		MTS 3	291.00	170.00	9002450265900
1.0531			MTS 3	291.00	170.00	9002450267500
1.0626	1 1/16		MTS 3	291.00	170.00	9002450269900
1.0630			MTS 3	291.00	170.00	9002450270000
1.0728			MTS 3	291.00	170.00	9002450272500
1.0780	1 5/64		MTS 3	291.00	170.00	9002450273800
1.0827			MTS 3	291.00	170.00	9002450275000
1.0925			MTS 3	291.00	170.00	9002450277500
1.0937	1 3/32		MTS 3	291.00	170.00	9002450277800
1.0945			MTS 3	291.00	170.00	9002450278000
1.1024			MTS 3	291.00	170.00	9002450280000
1.1122			MTS 3	296.00	175.00	9002450282500
1.1220			MTS 3	296.00	175.00	9002450285000
1.1248	1 1/8		MTS 3	296.00	175.00	9002450285700

Dec. inch	Diameter (d1)		Shank size	l1 mm	l2 mm	EDP #
	Fract. inch	Wire / letter				
1.1319			MTS 3	296.00	175.00	9002450287500
1.1417			MTS 3	296.00	175.00	9002450290000
1.1516			MTS 3	296.00	175.00	9002450292500
1.1563	1 5/32		MTS 3	296.00	175.00	9002450293700
1.1614			MTS 3	296.00	175.00	9002450295000
1.1713			MTS 3	296.00	175.00	9002450297500
1.1811			MTS 3	296.00	175.00	9002450300000
1.1874	1 3/16		MTS 3	301.00	180.00	9002450301600
1.1909			MTS 3	301.00	180.00	9002450302500
1.2008			MTS 3	301.00	180.00	9002450305000
1.2106			MTS 3	301.00	180.00	9002450307500
1.2205			MTS 3	301.00	180.00	9002450310000
1.2303			MTS 3	301.00	180.00	9002450312500
1.2402			MTS 3	301.00	180.00	9002450315000
1.2500	1 1/4		MTS 3	306.00	185.00	9002450317500
1.2598			MTS 4	334.00	185.00	9002450320000
1.2657	1 17/64		MTS 4	334.00	185.00	9002450321500
1.2697			MTS 4	334.00	185.00	9002450322500
1.2795			MTS 4	334.00	185.00	9002450325000
1.2811	1 9/32		MTS 4	334.00	185.00	9002450325400
1.2992			MTS 4	334.00	185.00	9002450330000
1.3126	1 5/16		MTS 4	334.00	185.00	9002450333400
1.3189			MTS 4	334.00	185.00	9002450335000
1.3280	1 21/64		MTS 4	339.00	190.00	9002450337300
1.3386			MTS 4	339.00	190.00	9002450340000
1.3437	1 11/32		MTS 4	339.00	190.00	9002450341300
1.3583			MTS 4	339.00	190.00	9002450345000
1.3748	1 3/8		MTS 4	339.00	190.00	9002450349200
1.3780			MTS 4	339.00	190.00	9002450350000
1.3976			MTS 4	339.00	190.00	9002450355000
1.4173			MTS 4	344.00	195.00	9002450360000
1.4370			MTS 4	344.00	195.00	9002450365000
1.4567			MTS 4	344.00	195.00	9002450370000
1.4689	1 15/32		MTS 4	344.00	195.00	9002450373100
1.4764			MTS 4	344.00	195.00	9002450375000
1.4961			MTS 4	349.00	200.00	9002450380000
1.5000	1 1/2		MTS 4	349.00	200.00	9002450381000
1.6094	1 39/64		MTS 4	354.00	205.00	9002450408800
1.7189	1 23/32		MTS 4	359.00	210.00	9002450436600
1.7811	1 25/32		MTS 4	364.00	215.00	9002450452400
1.8437	1 27/32		MTS 4	364.00	215.00	9002450468300
1.9220	1 59/64		MTS 4	369.00	220.00	9002450488200
2.1874	2 3/16		MTS 5	417.00	230.00	9002450555600
3.1248	3 1/8		MTS 6	514.00	260.00	9002450793700

Alternative Drill Series:

- #654 HSS, GP, 5xD, 118 pt, TiN
- #345 Cobalt, GP, 5xD, 118 pt, Oxide
- #661 Cobalt, GT100, 5xD, 130 pt, TiN

10xD



Speeds & Feeds
information pg 430

Series 257



General Purpose

HSS, general purpose (Type N), bushing length, 118° point,
Form A web thinned >14.0mm dia., Morse Taper shank, RH helix

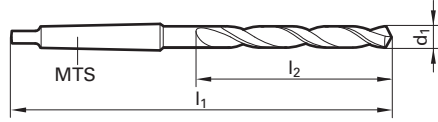
Cut / Shank Dia. = h8 tolerance range



Application Materials:

-  General Steels/Brass
-  Universal Steels
-  Cast Iron

Twist Drills

Diameter (d1)			Shank size	l1 mm	l2 mm	EDP #
Dec. inch	Fract. inch	Wire / letter				
0.1575			MTS 1	145.00	64.00	9002570040000
0.2008			MTS 1	155.00	74.00	9002570051000
0.2520			MTS 1	167.00	86.00	9002570064000
0.2559			MTS 1	167.00	86.00	9002570065000
0.2657	17/64	H	MTS 1	174.00	93.00	9002570067500
0.3228		P	MTS 1	181.00	100.00	9002570082000
0.3346			MTS 1	181.00	100.00	9002570085000
0.3740			MTS 1	188.00	107.00	9002570095000
0.3937			MTS 1	197.00	116.00	9002570100000
0.3976			MTS 1	197.00	116.00	9002570101000
0.4016			MTS 1	197.00	116.00	9002570102000
0.4035			MTS 1	197.00	116.00	9002570102500
0.4055			MTS 1	197.00	116.00	9002570103000
0.4094			MTS 1	197.00	116.00	9002570104000
0.4134			MTS 1	197.00	116.00	9002570105000
0.4173			MTS 1	197.00	116.00	9002570106000
0.4213			MTS 1	206.00	125.00	9002570107000
0.4232			MTS 1	206.00	125.00	9002570107500
0.4252			MTS 1	206.00	125.00	9002570108000
0.4291			MTS 1	206.00	125.00	9002570109000
0.4331			MTS 1	206.00	125.00	9002570110000
0.4370			MTS 1	206.00	125.00	9002570111000
0.4409			MTS 1	206.00	125.00	9002570112000
0.4429			MTS 1	206.00	125.00	9002570112500
0.4449			MTS 1	206.00	125.00	9002570113000
0.4488			MTS 1	206.00	125.00	9002570114000
0.4528			MTS 1	206.00	125.00	9002570115000
0.4567			MTS 1	206.00	125.00	9002570116000
0.4626			MTS 1	206.00	125.00	9002570117500
0.4646			MTS 1	206.00	125.00	9002570118000
0.4685			MTS 1	215.00	134.00	9002570119000
0.4724			MTS 1	215.00	134.00	9002570120000
0.4764			MTS 1	215.00	134.00	9002570121000
0.4803			MTS 1	215.00	134.00	9002570122000
0.4823			MTS 1	215.00	134.00	9002570122500
0.4843	31/64		MTS 1	215.00	134.00	9002570123000
0.4882			MTS 1	215.00	134.00	9002570124000
0.4921			MTS 1	215.00	134.00	9002570125000
0.4961			MTS 1	215.00	134.00	9002570126000
0.5000	1/2		MTS 1	215.00	134.00	9002570127000
0.5020			MTS 1	215.00	134.00	9002570127500
0.5039			MTS 1	215.00	134.00	9002570128000
0.5118			MTS 1	215.00	134.00	9002570130000
0.5157	33/64		MTS 1	215.00	134.00	9002570131000
0.5197			MTS 1	215.00	134.00	9002570132000
0.5217			MTS 1	223.00	142.00	9002570132500
0.5236			MTS 1	223.00	142.00	9002570133000
0.5311	17/32		MTS 1	223.00	142.00	9002570134900
0.5315			MTS 1	223.00	142.00	9002570135000
0.5354			MTS 1	223.00	142.00	9002570136000
0.5413			MTS 1	223.00	142.00	9002570137500
0.5433			MTS 1	223.00	142.00	9002570138000
0.5472			MTS 1	223.00	142.00	9002570139000
0.5512			MTS 1	223.00	142.00	9002570140000

Diameter (d1)			Shank size	l1 mm	l2 mm	EDP #
Dec. inch	Fract. inch	Wire / letter				
0.5551			MTS 2	245.00	147.00	9002570141000
0.5591			MTS 2	245.00	147.00	9002570142000
0.5610			MTS 2	245.00	147.00	9002570142500
0.5626	9/16		MTS 2	245.00	147.00	9002570142900
0.5630			MTS 2	245.00	147.00	9002570143000
0.5709			MTS 2	245.00	147.00	9002570145000
0.5807			MTS 2	245.00	147.00	9002570147500
0.5827			MTS 2	245.00	147.00	9002570148000
0.5866			MTS 2	245.00	147.00	9002570149000
0.5906			MTS 2	245.00	147.00	9002570150000
0.5937	19/32		MTS 2	251.00	153.00	9002570150800
0.5945			MTS 2	251.00	153.00	9002570151000
0.5984			MTS 2	251.00	153.00	9002570152000
0.6004			MTS 2	251.00	153.00	9002570152500
0.6024			MTS 2	251.00	153.00	9002570153000
0.6102			MTS 2	251.00	153.00	9002570155000
0.6142			MTS 2	251.00	153.00	9002570156000
0.6201			MTS 2	251.00	153.00	9002570157500
0.6220			MTS 2	251.00	153.00	9002570158000
0.6248	5/8		MTS 2	251.00	153.00	9002570158700
0.6299			MTS 2	251.00	153.00	9002570160000
0.6339			MTS 2	257.00	159.00	9002570161000
0.6398			MTS 2	257.00	159.00	9002570162500
0.6406	41/64		MTS 2	257.00	159.00	9002570162700
0.6457			MTS 2	257.00	159.00	9002570164000
0.6496			MTS 2	257.00	159.00	9002570165000
0.6563	21/32		MTS 2	257.00	159.00	9002570166700
0.6594			MTS 2	257.00	159.00	9002570167500
0.6693			MTS 2	257.00	159.00	9002570170000
0.6791			MTS 2	263.00	165.00	9002570172500
0.6874	11/16		MTS 2	263.00	165.00	9002570174600
0.6890			MTS 2	263.00	165.00	9002570175000
0.6988			MTS 2	263.00	165.00	9002570177500
0.7087			MTS 2	263.00	165.00	9002570180000
0.7185			MTS 2	269.00	171.00	9002570182500
0.7189	23/32		MTS 2	269.00	171.00	9002570182600
0.7283			MTS 2	269.00	171.00	9002570185000
0.7382			MTS 2	269.00	171.00	9002570187500
0.7480			MTS 2	269.00	171.00	9002570190000
0.7579			MTS 2	275.00	177.00	9002570192500
0.7677			MTS 2	275.00	177.00	9002570195000
0.7776			MTS 2	275.00	177.00	9002570197500
0.7811	25/32		MTS 2	275.00	177.00	9002570198400
0.7874			MTS 2	275.00	177.00	9002570200000
0.7972			MTS 2	282.00	184.00	9002570202500
0.8071			MTS 2	282.00	184.00	9002570205000
0.8126	13/16		MTS 2	282.00	184.00	9002570206400
0.8268			MTS 2	282.00	184.00	9002570210000
0.8465			MTS 2	289.00	191.00	9002570215000
0.8563			MTS 2	289.00	191.00	9002570217500
0.8661			MTS 2	289.00	191.00	9002570220000
0.8748	7/8		MTS 2	289.00	191.00	9002570222200
0.8760			MTS 2	289.00	191.00	9002570222500
0.8858			MTS 2	296.00	198.00	9002570225000

*Items listed in red are non-stocked items, and may take 2 - 6 weeks to receive

Series 257

Speeds & Feeds information pg 430

Diameter (d1)		Shank size	l1	l2	EDP #	
Dec. inch	Fract. inch					
0.9055		23.000	MTS 2	296.00	198.00	9002570230000
0.9154		23.250	MTS 3	319.00	198.00	9002570232500
0.9252		23.500	MTS 3	319.00	198.00	9002570235000
0.9350		23.750	MTS 3	327.00	206.00	9002570237500
0.9374	15/16	23.810	MTS 3	327.00	206.00	9002570238100
0.9449		24.000	MTS 3	327.00	206.00	9002570240000
0.9547		24.250	MTS 3	327.00	206.00	9002570242500
0.9646		24.500	MTS 3	327.00	206.00	9002570245000
0.9843	63/64	25.000	MTS 3	327.00	206.00	9002570250000
0.9941		25.250	MTS 3	335.00	214.00	9002570252500
1.0039		25.500	MTS 3	335.00	214.00	9002570255000
1.0236		26.000	MTS 3	335.00	214.00	9002570260000

Diameter (d1)		Shank size	l1	l2	EDP #	
Dec. inch	Fract. inch					
1.0433		26.500	MTS 3	335.00	214.00	9002570265000
1.0630		27.000	MTS 3	343.00	222.00	9002570270000
1.0827		27.500	MTS 3	343.00	222.00	9002570275000
1.1024		28.000	MTS 3	343.00	222.00	9002570280000
1.1220		28.500	MTS 3	351.00	230.00	9002570285000
1.1417		29.000	MTS 3	351.00	230.00	9002570290000
1.1563	1 5/32	29.370	MTS 3	351.00	230.00	9002570293700

Alternative Drill Series:

#551 HSS, GT100, 10xD, 130 pt, Nitrided lands/ Steam Oxide > 16.00

Extra Length

#1



Steam Oxide



External Coolant

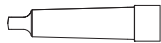

Morse Taper Shank

Speeds & Feeds information pg 430

Diameter (d1)		Shank size	l1	l2	EDP #	
Dec. inch	Fract. inch					
0.3346		8.500	MTS 1	265.00	165.00	9002660085000
0.3543		9.000	MTS 1	275.00	175.00	9002660090000
0.3937		10.000	MTS 1	285.00	185.00	9002660100000
0.4016		10.200	MTS 1	285.00	185.00	9002660102000
0.4035		10.250	MTS 1	285.00	185.00	9002660102500
0.4063	13/32	10.320	MTS 1	285.00	185.00	9002660103200
0.4134		10.500	MTS 1	285.00	185.00	9002660105000
0.4331		11.000	MTS 1	300.00	195.00	9002660110000
0.4374	7/16	11.110	MTS 1	300.00	195.00	9002660111100
0.4528		11.500	MTS 1	300.00	195.00	9002660115000
0.4646		11.800	MTS 1	300.00	195.00	9002660118000
0.4724		12.000	MTS 1	310.00	205.00	9002660120000
0.4921		12.500	MTS 1	310.00	205.00	9002660125000
0.5000	1/2	12.700	MTS 1	310.00	205.00	9002660127000
0.5118		13.000	MTS 1	310.00	205.00	9002660130000
0.5311	17/32	13.490	MTS 1	325.00	220.00	9002660134900
0.5315		13.500	MTS 1	325.00	220.00	9002660135000
0.5512		14.000	MTS 1	325.00	220.00	9002660140000
0.5626	9/16	14.290	MTS 2	340.00	220.00	9002660142900
0.5709		14.500	MTS 2	340.00	220.00	9002660145000
0.5906		15.000	MTS 2	340.00	220.00	9002660150000
0.6004		15.250	MTS 2	355.00	230.00	9002660152500
0.6102		15.500	MTS 2	355.00	230.00	9002660155000
0.6299		16.000	MTS 2	355.00	230.00	9002660160000
0.6496		16.500	MTS 2	355.00	230.00	9002660165000

Series 266

General Purpose

HSS, general purpose (Type N), extra length #1, 118° point, Form A web thinned all dia., Morse Taper shank, RH helix

Cut / Shank Dia. = h8 tolerance range

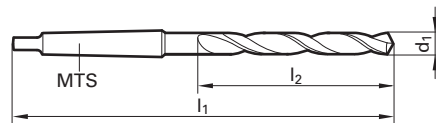

Application Materials:



General Steels/Brass



Universal Steels



Cast Iron

Diameter (d1)		Shank size	l1	l2	EDP #	
Dec. inch	Fract. inch					
0.6563	21/32	16.670	MTS 2	355.00	230.00	9002660166700
0.6693		17.000	MTS 2	355.00	230.00	9002660170000
0.6890		17.500	MTS 2	370.00	245.00	9002660175000
0.7087		18.000	MTS 2	370.00	245.00	9002660180000
0.7283		18.500	MTS 2	370.00	245.00	9002660185000
0.7343	47/64	18.650	MTS 2	370.00	245.00	9002660186500
0.7480		19.000	MTS 2	370.00	245.00	9002660190000
0.7500	3/4	19.050	MTS 2	385.00	260.00	9002660190500
0.7677		19.500	MTS 2	385.00	260.00	9002660195000
0.7776		19.750	MTS 2	385.00	260.00	9002660197500
0.7874		20.000	MTS 2	385.00	260.00	9002660200000
0.8071		20.500	MTS 2	385.00	260.00	9002660205000
0.8126	13/16	20.640	MTS 2	385.00	260.00	9002660206400
0.8268		21.000	MTS 2	385.00	260.00	9002660210000
0.8465		21.500	MTS 2	405.00	270.00	9002660215000
0.8661		22.000	MTS 2	405.00	270.00	9002660220000
0.8858		22.500	MTS 2	405.00	270.00	9002660225000
0.9055		23.000	MTS 2	405.00	270.00	9002660230000
0.9063	29/32	23.020	MTS 2	405.00	270.00	9002660230200
1.3386		34.000	MTS 4	530.00	340.00	9002660340000



Alternative Drill Series:

#526 HSS, GT100, >10xD, 130 pt, Nitrided lands/ Steam Oxide > 16.00
#620 Cobalt, GT100, >10xD, 130 pt, Nitrided lands/ Steam Oxide > 16.00

Center Drill/Countersink

Non-flatted body, 60° angle

Tolerance information can be found in the Technical Section, Page 370

-  General Steels/Brass
-  Universal Steels
-  Cast Iron

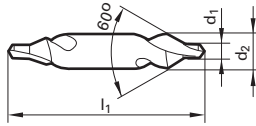

Series	581	613	381	590	736	582	583	614	584
	Standard	DIN 333	DIN 333	DIN 333	GUH STD	GUH STD	DIN 333	DIN 333	DIN 333
Substrate	HSS	HSS	Cobalt	HSS	Carbide	HSS	HSS	HSS	HSS
Cut Direction	RH	RH	RH	RH	RH	LH	RH	RH	LH
Form	A	A	A	A	A	A	R	R	R
Feature				Reinforced neck					
Surface Finish	○	Ⓢ	○	○	○	○	○	Ⓢ	○

Order Code	d1	d2	l1	EDP #	EDP #	EDP #	EDP #	EDP #	EDP #	EDP #	EDP #	EDP #
0.500*	0.50	3.15	25.0	9005810005000	9006130005000			9007360005000	9005820005000	9005830005000		
0.800*	0.80	3.15	25.0	9005810008000	9006130008000			9007360008000	9005820008000	9005830008000	9006140008000	9005840008000
1.000	1.00	3.15	31.5	9005810010000	9006130010000	9003810010000	9005900010000	9007360010000	9005820010000	9005830010000	9006140010000	9005840010000
1.250	1.25	3.15	31.5	9005810012500	9006130012500	9003810012500	9005900012500	9007360012500	9005820012500	9005830012500	9006140012500	9005840012500
1.600	1.60	4.00	35.5	9005810016000	9006130016000	9003810016000	9005900016000	9007360016000	9005820016000	9005830016000	9006140016000	9005840016000
2.000	2.00	5.00	40.0	9005810020000	9006130020000	9003810020000	9005900020000	9007360020000	9005820020000	9005830020000	9006140020000	9005840020000
2.500	2.50	6.30	45.0	9005810025000	9006130025000	9003810025000	9005900025000	9007360025000	9005820025000	9005830025000	9006140025000	9005840025000
3.150	3.15	8.00	50.0	9005810031500	9006130031500	9003810031500	9005900031500	9007360031500	9005820031500	9005830031500	9006140031500	9005840031500
4.000	4.00	10.00	56.0	9005810040000	9006130040000	9003810040000	9005900040000	9007360040000	9005820040000	9005830040000	9006140040000	9005840040000
5.000	5.00	12.50	63.0	9005810050000	9006130050000		9005900050000	9007360050000	9005820050000	9005830050000	9006140050000	9005840050000
6.300	6.30	16.00	71.0	9005810063000	9006130063000		9005900063000	9007360063000	9005820063000	9005830063000	9006140063000	
8.000	8.00	20.00	80.0	9005810080000	9006130080000		9005900080000	9007360080000	9005820080000	9005830080000	9006140080000	
10.000	10.00	25.00	100.0	9005810100000			9005900100000					

Series	281	282	283	284
	Standard	GUH STD	GUH STD	GUH STD
Substrate	HSS	HSS	HSS	HSS
Cut Direction	RH	LH	RH	LH
Form	A	A	R	R
Feature				
Surface Finish	○	○	○	○

Order Code	d1	d2	l1	EDP #	EDP #	EDP #	EDP #
0.500*	0.50	3.15	25.0	9002810005000		9002830005000	
0.800*	0.80	3.15	25.0	9002810008000	9002820008000	9002830008000	
1.000	1.00	3.15	31.5	9002810010000	9002820010000	9002830010000	
1.250	1.25	4.00	35.5	9002810012500	9002820012500	9002830012500	9002840012500
1.600	1.60	5.00	40.0	9002810016000	9002820016000	9002830016000	9002840016000
2.000	2.00	6.30	45.0	9002810020000	9002820020000	9002830020000	9002840020000
2.500	2.50	8.00	50.0	9002810025000	9002820025000	9002830025000	9002840025000
3.150	3.15	10.00	56.0	9002810031500	9002820031500	9002830031500	9002840031500
4.000	4.00	12.50	63.0	9002810040000	9002820040000	9002830040000	9002840040000
5.000	5.00	16.00	71.0	9002810050000	9002820050000	9002830050000	
6.300	6.30	20.00	80.0	9002810063000		9002830063000	
8.000	8.00	25.00	100.0	9002810080000		9002830080000	
10.000	10.00	31.50	125.0	9002810100000		9002830100000	

Series	280
	Standard
Substrate	HSS
Cut Direction	RH
Form	A
Feature	Long length
Surface Finish	○

Order Code	d1	d2	l1	EDP #
1.00	1.00	4.00	120.0	9002800010000
1.60	1.60	5.00	120.0	9002800016000
2.00	2.00	6.00	120.0	9002800020000
2.50	2.50	8.00	120.0	9002800025000
3.15	3.15	10.00	120.0	9002800031500

○ bright

Ⓢ TiN

Metric

Center Drill/Countersink

Non-flatted body, double angle 60°/120°

Tolerance information can be found in the Technical Section, Page 370

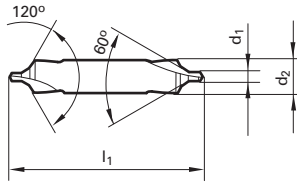

- General Steels/Brass
- Universal Steels
- Cast Iron

	Series	585	586	591			
	Standard	DIN 333	DIN 333	DIN 333			
	Substrate	HSS	HSS	HSS			
	Cut Direction	RH	LH	RH			
	Form	B	B	B			
	Feature			Reinforced neck			
	Surface Finish	○	○	○			
Order Code	d1	d2	l1	EDP #	EDP #	EDP #	
1.00	1.00	4.00	35.5	9005850010000	9005860010000	9005910010000	
1.25	1.25	5.00	40.0	9005850012500	9005860012500	9005910012500	
1.60	1.60	6.30	45.0	9005850016000	9005860016000	9005910016000	
2.00	2.00	8.00	50.0	9005850020000	9005860020000	9005910020000	
2.50	2.50	10.00	56.0	9005850025000	9005860025000	9005910025000	
3.15	3.15	11.20	60.0	9005850031500	9005860031500	9005910031500	
4.00	4.00	14.00	67.0	9005850040000	9005860040000	9005910040000	
5.00	5.00	18.00	75.0	9005850050000	9005860050000	9005910050000	
6.30	6.30	20.00	80.0	9005850063000	9005860063000	9005910063000	
8.00	8.00	25.00	100.0	9005850080000	9005860080000	9005910080000	
10.00	10.00	31.50	125.0	9005850100000	9005860100000	9005910100000	

	Series	285		
	Standard	GUH STD		
	Substrate	HSS		
	Cut Direction	RH		
	Form	B		
	Feature			
	Surface Finish	○		
Order Code	d1	d2	l1	EDP #
1.000	1.00	1.000	6.300	9002850010000
1.600	1.60	1.600	8.000	9002850016000
2.000	2.00	2.000	10.000	9002850020000
2.500	2.50	2.500	11.200	9002850025000
3.150	3.15	3.150	14.000	9002850031500
4.000	4.00	4.000	16.000	9002850040000
5.000	5.00	5.000	20.000	9002850050000
6.300	6.30	6.300	25.000	9002850063000

Technical Specifications - Form A Center Drills				
Standard	DIN 333	GUH STD	British Std. 328	ASA (USA Std.)
Point grind	relieved cone	relieved cone	relieved cone	relieved cone
Point angle	118°	118°	118°	118°
Web thin	1.6 mm dia up to DIN 1412, form A	1.6 mm dia up to DIN 1412, form A	to DIN 1412, form A	> 1.6 mm dia to DIN 1412, form A
Description	Standard drill for producing center holes to DIN 332, sheet 1, Form A (without protecting chamfer)			

Technical Specifications - Form B Center Drills			
Standard	DIN 333	GUH STD	ASA (USA Std.)
Point grind	relieved cone	relieved cone	relieved cone
Point angle	118	118	118
Web thin	1.6 mm dia up to DIN 1412, form A	1.6 mm dia up to DIN 1412, form A	to DIN 1412, form A
Description	Special purpose drill for producing center holes to DIN 332, sheet 1, form B (with protecting countersink of 120 deg.)		
Series 591 has a reinforced neck for higher metal removal rates.			



Technical Specifications - Form R Center Drills		
Standard	DIN 333	GUH STD
Point grind	relieved cone	relieved cone
Point angle	118	118
Web thin	1.6 mm dia up to DIN 1412, form A	1.6 mm dia up to DIN 1412, form A
Description	Special purpose drill for producing center holes to DIN 332, sheet 1, form R (radiused)	
Radius form for high fracture resistance properties, precise concentricity of the point in relationship with the body and a protected center hole.		

Number
Size

Center Drill/Countersink



Non-flatted body, 60° angle



Tolerance information can be found in the Technical Section, Page 370

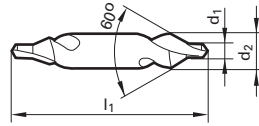

-  General Steels/Brass
-  Universal Steels
-  Cast Iron

Twist Drills



		Series	594		
		Standard	ASA		
		Substrate	HSS		
		Cut Direction	RH		
		Form	A		
		Surface Finish			
Order Code	Size	d1	d2	l1	EDP #
1.19	1	3/64	1/8	1 1/4	9005940011900
1.98	2	5/64	3/16	1 7/8	9005940019800
2.78	3	7/64	1/4	2	9005940027800
3.17	4	1/8	5/16	2 1/8	9005940031700
4.76	5	3/16	7/16	2 3/4	9005940047600
5.56	6	7/32	1/2	3	9005940055600
6.35	7	1/4	5/8	3 1/4	9005940063500
7.94	8	5/16	3/4	3 1/2	9005940079400

		Series	595		
		Standard	ASA		
		Substrate	HSS		
		Cut Direction	RH		
		Form	B		
		Surface Finish			
Order Code	Size	d1	d2	l1	EDP #
1.19	11	3/64	1/8	1 1/4	9005950011900
1.59	12	5/16	3/16	1 7/8	9005950015900
2.38	13	3/32	1/4	2	9005950023800
2.78	14	7/64	5/16	2 1/8	9005950027800
3.97	15	5/32	7/16	2 3/4	9005950039700
4.76	16	3/16	1/2	3	9005950047600
5.56	17	7/32	5/8	3 1/4	9005950055600
6.35	18	1/4	3/4	3 1/2	9005950063500

		Series	292	294		
		Standard	BRITISH 328	BRITISH 328		
		Substrate	HSS	HSS		
		Cut Direction	RH	LH		
		Form	A	A		
		Surface Finish				
Order Code	Size	d1	d2	l1	EDP #	EDP #
1.19	1	3/64	1/8	1 1/2	9002920011900	9002940011900
1.59	2	1/16	3/16	1	9002920015900	9002940015900
2.38	3	3/32	1/4	2	9002920023800	9002940023800
3.17	4	1/8	5/16	2 1/4	9002920031700	9002940031700
4.76	5	3/16	7/16	2 15/32	9002920047600	9002940047600
6.35	6	1/4	5/8	3	9002920063500	9002940063500
7.94	7	5/16	3/4	3 1/2	9002920079400	9002940079400

Technical Specifications - Form A Center Drills				
Standard	DIN 333	GUH STD	British Std. 328	ASA (USA Std.)
Point grind	relieved cone	relieved cone	relieved cone	relieved cone
Point angle	118°	118°	118°	118°
Web thin	1.6 mm dia up to DIN 1412, form A	1.6 mm dia up to DIN 1412, form A	to DIN 1412, form A	> 1.6 mm dia to DIN 1412, form A
Description	Standard drill for producing center holes to DIN 332, sheet 1, Form A (without protecting chamfer)			

Technical Specifications - Form B Center Drills			
Standard	DIN 333	GUH STD	ASA (USA Std.)
Point grind	relieved cone	relieved cone	relieved cone
Point angle	118	118	118
Web thin	1.6 mm dia up to DIN 1412, form A	1.6 mm dia up to DIN 1412, form A	to DIN 1412, form A
Description	Special purpose drill for producing center holes to DIN 332, sheet 1, form B (with protecting countersink of 120 deg.)		
Series 591 has a reinforced neck for higher metal removal rates.			



Technical Specifications - Form R Center Drills		
Standard	DIN 333	GUH STD
Point grind	relieved cone	relieved cone
Point angle	118	118
Web thin	1.6 mm dia up to DIN 1412, form A	1.6 mm dia up to DIN 1412, form A
Description	Special purpose drill for producing center holes to DIN 332, sheet 1, form R (radius)	
Radius form for high fracture resistance properties, precise concentricity of the point in relationship with the body and a protected center hole.		

*Items listed in red are non-stocked items, and may take 2 - 6 weeks to receive

Center Drill/Countersink

Flatted body

Tolerance information can be found in the Technical Section, Page 370

-  General Steels/Brass
-  Universal Steels
-  Cast Iron

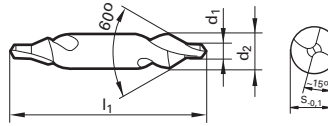

	Series	587	588			
	Standard	GUH STD	GUH STD			
	Substrate	HSS	HSS			
	Cut Direction	RH	RH			
	Form	A	R			
	Feature	60° angle	60° angle			
	Surface Finish					
Order Code	d1	d2	l1	S	EDP #	EDP #
1.600	1.60	4.00	35.5	3.25	9005870016000	9005880016000
2.000	2.00	5.00	40.0	4.20	9005870020000	9005880020000
2.500	2.50	6.30	45.0	5.35	9005870025000	9005880025000
3.150	3.15	8.00	50.0	6.95	9005870031500	9005880031500
4.000	4.00	10.00	56.0	8.40	9005870040000	9005880040000
5.000	5.00	12.50	63.0	10.95	9005870050000	9005880050000
6.300	6.30	16.00	71.0	14.00	9005870063000	9005880063000
8.000	8.00	20.00	80.0	17.90	9005870080000	9005880080000
10.000	10.00	25.00	100.0	22.50	9005870100000	9005880100000

	Series	589			
	Standard	GUH STD			
	Substrate	HSS			
	Cut Direction	RH			
	Form	B			
	Feature	60°/120° double angle			
	Surface Finish				
Order Code	d1	d2	l1	S	EDP #
1.600	1.60	6.30	45.0	5.35	9005890016000
2.000	2.00	8.00	50.0	6.95	9005890020000
2.500	2.50	10.00	56.0	8.40	9005890025000
3.150	3.15	11.20	60.0	10.00	9005890031500
4.000	4.00	14.00	67.0	12.65	9005890040000
5.000	5.00	18.00	75.0	16.40	9005890050000
6.300	6.30	20.00	80.0	17.90	9005890063000
8.000	8.00	25.00	100.0	22.50	9005890080000

	Series	287	288			
	Standard	GUH STD	GUH STD			
	Substrate	HSS	HSS			
	Cut Direction	RH	RH			
	Form	A	R			
	Feature	60° angle	60° angle			
	Surface Finish					
Order Code	d1	d2	l1	S	EDP #	EDP #
1.600	1.60	5.00	40.0	4.20	9002870016000	9002880016000
2.000	2.00	6.30	45.0	5.35	9002870020000	9002880020000
2.500	2.50	8.00	50.0	6.85	9002870025000	9002880025000
3.150	3.15	10.00	56.0	8.40	9002870031500	9002880031500
4.000	4.00	12.50	63.0	10.65	9002870040000	9002880040000
5.000	5.00	16.00	71.0	13.65	9002870050000	9002880050000
6.300	6.30	20.00	80.0	17.40	9002870063000	9002880063000
8.000	8.00	8.00	100.0	25.00	9002870080000	9002880080000
10.000	10.00	10.00	125.0	31.50	9002870100000	9002880100000

	Series	289			
	Standard	GUH STD			
	Substrate	HSS			
	Cut Direction	RH			
	Form	B			
	Feature	60°/120° double angle			
	Surface Finish				
Order Code	d1	d2	l1	S	EDP #
1.600	1.60	8.00	50.0	6.50	9002890016000
2.000	2.00	10.00	56.0	7.95	9002890020000
2.500	2.50	11.20	63.0	9.50	9002890025000
3.150	3.15	14.00	71.0	12.00	9002890031500
4.000	4.00	16.00	80.0	14.40	9002890040000
5.000	5.00	20.00	90.0	18.40	9002890050000

Series 301

Speeds & Feeds information pg 431

Twist Drills

Diameter (d1)		Wire / letter	d2 mm	l1 mm	l2 mm	EDP #	
Dec. inch	Fract. inch						
0.0262			0.665	1.000	25.00	4.20	9003010006650
0.0264			0.670	1.000	25.00	4.20	9003010006700
0.0266			0.675	1.000	25.00	4.80	9003010006750
0.0268			0.680	1.000	25.00	4.80	9003010006800
0.0272			0.690	1.000	25.00	4.80	9003010006900
0.0276			0.700	1.000	25.00	4.80	9003010007000
0.0278			0.705	1.000	25.00	4.80	9003010007050
0.0280		70	0.710	1.000	25.00	4.80	9003010007100
0.0283			0.720	1.000	25.00	4.80	9003010007200
0.0285			0.725	1.000	25.00	4.80	9003010007250
0.0287			0.730	1.000	25.00	4.80	9003010007300
0.0291		69	0.740	1.000	25.00	4.80	9003010007400
0.0295			0.750	1.000	25.00	4.80	9003010007500
0.0299			0.760	1.000	25.00	5.30	9003010007600
0.0303			0.770	1.000	25.00	5.30	9003010007700
0.0307			0.780	1.000	25.00	5.30	9003010007800
0.0311	1/32	68	0.790	1.000	25.00	5.30	9003010007900
0.0313			0.795	1.500	25.00	5.30	9003010007950
0.0315			0.800	1.500	25.00	5.30	9003010008000
0.0319		67	0.810	1.500	25.00	5.30	9003010008100
0.0323			0.820	1.500	25.00	5.30	9003010008200
0.0327			0.830	1.500	25.00	5.30	9003010008300
0.0331		66	0.840	1.500	25.00	5.30	9003010008400
0.0335			0.850	1.500	25.00	5.30	9003010008500
0.0339			0.860	1.500	25.00	6.00	9003010008600
0.0343			0.870	1.500	25.00	6.00	9003010008700
0.0346			0.880	1.500	25.00	6.00	9003010008800
0.0350		65	0.890	1.500	25.00	6.00	9003010008900
0.0354			0.900	1.500	25.00	6.00	9003010009000
0.0358		64	0.910	1.500	25.00	6.00	9003010009100
0.0362			0.920	1.500	25.00	6.00	9003010009200
0.0364			0.925	1.500	25.00	6.00	9003010009250
0.0366			0.930	1.500	25.00	6.00	9003010009300
0.0370		63	0.940	1.500	25.00	6.00	9003010009400
0.0374			0.950	1.500	25.00	6.00	9003010009500
0.0378			0.960	1.500	25.00	6.80	9003010009600
0.0382		62	0.970	1.500	25.00	6.80	9003010009700
0.0386			0.980	1.500	25.00	6.80	9003010009800
0.0390		61	0.990	1.500	25.00	6.80	9003010009900
0.0394			1.000	1.500	25.00	6.80	9003010010000
0.0398			1.010	1.500	25.00	6.80	9003010010100
0.0402		60	1.020	1.500	25.00	6.80	9003010010200
0.0406			1.030	1.500	25.00	6.80	9003010010300
0.0409		59	1.040	1.500	25.00	6.80	9003010010400
0.0413			1.050	1.500	25.00	6.80	9003010010500
0.0415			1.055	1.500	25.00	6.80	9003010010550
0.0417			1.060	1.500	25.00	6.80	9003010010600
0.0421		58	1.070	1.500	25.00	7.60	9003010010700
0.0425			1.080	1.500	25.00	7.60	9003010010800
0.0429		57	1.090	1.500	25.00	7.60	9003010010900
0.0431			1.095	1.500	25.00	7.60	9003010010950
0.0433			1.100	1.500	25.00	7.60	9003010011000
0.0437			1.110	1.500	25.00	7.60	9003010011100
0.0441			1.120	1.500	25.00	7.60	9003010011200
0.0445			1.130	1.500	25.00	7.60	9003010011300
0.0449			1.140	1.500	25.00	7.60	9003010011400
0.0453			1.150	1.500	25.00	7.60	9003010011500
0.0457			1.160	1.500	25.00	7.60	9003010011600

Diameter (d1)		Wire / letter	d2 mm	l1 mm	l2 mm	EDP #	
Dec. inch	Fract. inch						
0.0461			1.170	1.500	25.00	7.60	9003010011700
0.0463			1.175	1.500	25.00	7.60	9003010011750
0.0465		56	1.180	1.500	25.00	7.60	9003010011800
0.0469	3/64		1.190	1.500	25.00	8.50	9003010011900
0.0472			1.200	1.500	25.00	8.50	9003010012000
0.0476			1.210	1.500	25.00	8.50	9003010012100
0.0480			1.220	1.500	25.00	8.50	9003010012200
0.0484			1.230	1.500	25.00	8.50	9003010012300
0.0488			1.240	1.500	25.00	8.50	9003010012400
0.0492			1.250	1.500	25.00	8.50	9003010012500
0.0496			1.260	1.500	25.00	8.50	9003010012600
0.0498			1.265	1.500	25.00	8.50	9003010012650
0.0500			1.270	1.500	25.00	8.50	9003010012700
0.0504			1.280	1.500	25.00	8.50	9003010012800
0.0508			1.290	1.500	25.00	8.50	9003010012900
0.0512			1.300	1.500	25.00	8.50	9003010013000
0.0516			1.310	1.500	25.00	8.50	9003010013100
0.0520		55	1.320	1.500	25.00	8.50	9003010013200
0.0524			1.330	1.500	25.00	9.50	9003010013300
0.0528			1.340	1.500	25.00	9.50	9003010013400
0.0531			1.350	1.500	25.00	9.50	9003010013500
0.0539			1.370	1.500	25.00	9.50	9003010013700
0.0543			1.380	1.500	25.00	9.50	9003010013800
0.0547			1.390	1.500	25.00	9.50	9003010013900
0.0551		54	1.400	1.500	25.00	9.50	9003010014000
0.0555			1.410	1.500	25.00	9.50	9003010014100
0.0559			1.420	1.500	25.00	9.50	9003010014200
0.0563			1.430	1.500	25.00	9.50	9003010014300
0.0567			1.440	1.500	25.00	9.50	9003010014400
0.0571			1.450	1.500	25.00	9.50	9003010014500
0.0575			1.460	2.000	30.00	9.50	9003010014600
0.0579			1.470	2.000	30.00	9.50	9003010014700
0.0591			1.500	2.000	30.00	9.50	9003010015000
0.0602			1.530	2.000	30.00	10.60	9003010015300
0.0610			1.550	2.000	30.00	10.60	9003010015500
0.0626	1/16		1.590	2.000	30.00	10.60	9003010015900
0.0630			1.600	2.000	30.00	10.60	9003010016000
0.0634		52	1.610	2.000	30.00	10.60	9003010016100
0.0650			1.650	2.000	30.00	10.60	9003010016500
0.0669		51	1.700	2.000	30.00	10.60	9003010017000
0.0673			1.710	2.000	30.00	11.80	9003010017100
0.0681			1.730	2.000	30.00	11.80	9003010017300
0.0687			1.745	2.000	30.00	11.80	9003010017450
0.0689			1.750	2.000	30.00	11.80	9003010017500
0.0699			1.775	2.000	30.00	11.80	9003010017750
0.0709			1.800	2.000	30.00	11.80	9003010018000
0.0720			1.830	2.000	30.00	11.80	9003010018300
0.0724			1.840	2.000	30.00	11.80	9003010018400
0.0728		49	1.850	2.000	30.00	11.80	9003010018500
0.0748			1.900	2.000	30.00	11.80	9003010019000
0.0756			1.920	2.000	30.00	13.20	9003010019200

Alternative Drill Series:

#660 Cobalt, Type N, 4xD, 118 pt, TiN
 #6400 Carbide, Type N, 4xD, 140 pt, Super-A
 #3899 Carbide, Type N, 5xD, 130 point, TiAlN

Micro



Bright Finish



External Coolant



Reinforced Straight Shank

Speeds & Feeds
information pg 431

Series 303

Micro-Precision, LH helix

Cobalt, Micro-Precision (Type N), 118° point,
reinforced straight shank, LH helix

Shank Dia. = h8 tolerance range, Cut Dia. +0 / -0.004

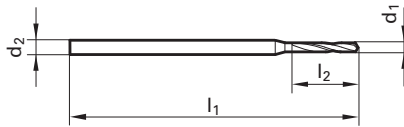

Application Materials:

- General Steels/Brass
- Universal Steels
- Stainless Steels
- Hardened Materials
- Cast Iron
- Ti & Ni Alloys
- Aluminum & Alloys

Twist Drills

Diameter (d1)		Wire / letter	d2 mm	l1 mm	l2 mm	EDP #
Dec. inch	Fract. inch					
0.0051			1.00	25.00	0.80	9003030001300
0.0055			1.00	25.00	0.80	9003030001400
0.0059	97		1.00	25.00	0.80	9003030001500
0.0063	96		1.00	25.00	1.10	9003030001600
0.0067	95		1.00	25.00	1.10	9003030001700
0.0071	94		1.00	25.00	1.10	9003030001800
0.0073			1.00	25.00	1.10	9003030001850
0.0075	93		1.00	25.00	1.10	9003030001900
0.0077			1.00	25.00	1.50	9003030001950
0.0079	92		1.00	25.00	1.50	9003030002000
0.0083	91		1.00	25.00	1.50	9003030002100
0.0085			1.00	25.00	1.50	9003030002150
0.0087	90		1.00	25.00	1.50	9003030002200
0.0089			1.00	25.00	1.50	9003030002250
0.0091	89		1.00	25.00	1.50	9003030002300
0.0094	88		1.00	25.00	1.50	9003030002400
0.0096			1.00	25.00	1.90	9003030002450
0.0098	87		1.00	25.00	1.90	9003030002500
0.0100			1.00	25.00	1.90	9003030002550
0.0102			1.00	25.00	1.90	9003030002600
0.0104			1.00	25.00	1.90	9003030002650
0.0106	86		1.00	25.00	1.90	9003030002700
0.0110	85		1.00	25.00	1.90	9003030002800
0.0114	84		1.00	25.00	1.90	9003030002900
0.0116			1.00	25.00	1.90	9003030002950
0.0118			1.00	25.00	1.90	9003030003000
0.0122	83		1.00	25.00	2.40	9003030003100
0.0126	82		1.00	25.00	2.40	9003030003200
0.0130	81		1.00	25.00	2.40	9003030003300
0.0134	80		1.00	25.00	2.40	9003030003400
0.0138			1.00	25.00	2.40	9003030003500
0.0142			1.00	25.00	2.40	9003030003600
0.0146	79		1.00	25.00	2.40	9003030003700
0.0150			1.00	25.00	2.40	9003030003800
0.0154			1.00	25.00	3.00	9003030003900
0.0157	1/64		1.00	25.00	3.00	9003030004000
0.0161	78		1.00	25.00	3.00	9003030004100
0.0165			1.00	25.00	3.00	9003030004200
0.0169			1.00	25.00	3.00	9003030004300
0.0173			1.00	25.00	3.00	9003030004400
0.0177			1.00	25.00	3.00	9003030004500
0.0181	77		1.00	25.00	3.00	9003030004600
0.0185			1.00	25.00	3.00	9003030004700
0.0189			1.00	25.00	3.00	9003030004800
0.0193			1.00	25.00	3.40	9003030004900
0.0197			1.00	25.00	3.40	9003030005000
0.0201	76		1.00	25.00	3.40	9003030005100
0.0205			1.00	25.00	3.40	9003030005200
0.0207			1.00	25.00	3.40	9003030005250
0.0209	75		1.00	25.00	3.40	9003030005300
0.0211			1.00	25.00	3.90	9003030005350
0.0213			1.00	25.00	3.90	9003030005400
0.0215			1.00	25.00	3.90	9003030005450
0.0217			1.00	25.00	3.90	9003030005500

Diameter (d1)		Wire / letter	d2 mm	l1 mm	l2 mm	EDP #
Dec. inch	Fract. inch					
0.0219			1.00	25.00	3.90	9003030005550
0.0220			1.00	25.00	3.90	9003030005600
0.0222			1.00	25.00	3.90	9003030005650
0.0224	74		1.00	25.00	3.90	9003030005700
0.0228			1.00	25.00	3.90	9003030005800
0.0232			1.00	25.00	3.90	9003030005900
0.0236			1.00	25.00	3.90	9003030006000
0.0240	73		1.00	25.00	4.20	9003030006100
0.0244			1.00	25.00	4.20	9003030006200
0.0248			1.00	25.00	4.20	9003030006300
0.0252	72		1.00	25.00	4.20	9003030006400
0.0256			1.00	25.00	4.20	9003030006500
0.0260	71		1.00	25.00	4.20	9003030006600
0.0264			1.00	25.00	4.20	9003030006700
0.0266			1.00	25.00	4.80	9003030006750
0.0268			1.00	25.00	4.80	9003030006800
0.0272			1.00	25.00	4.80	9003030006900
0.0276			1.00	25.00	4.80	9003030007000
0.0280	70		1.00	25.00	4.80	9003030007100
0.0283			1.00	25.00	4.80	9003030007200
0.0287			1.00	25.00	4.80	9003030007300
0.0291	69		1.00	25.00	4.80	9003030007400
0.0295			1.00	25.00	4.80	9003030007500
0.0299			1.00	25.00	5.30	9003030007600
0.0303			1.00	25.00	5.30	9003030007700
0.0307			1.00	25.00	5.30	9003030007800
0.0311	1/32	68	1.00	25.00	5.30	9003030007900
0.0315			1.50	25.00	5.30	9003030008000
0.0319	67		1.50	25.00	5.30	9003030008100
0.0323			1.50	25.00	5.30	9003030008200
0.0327			1.50	25.00	5.30	9003030008300
0.0331	66		1.50	25.00	5.30	9003030008400
0.0335			1.50	25.00	5.30	9003030008500
0.0339			1.50	25.00	6.00	9003030008600
0.0343			1.50	25.00	6.00	9003030008700
0.0346			1.50	25.00	6.00	9003030008800
0.0350	65		1.50	25.00	6.00	9003030008900
0.0354			1.50	25.00	6.00	9003030009000
0.0358	64		1.50	25.00	6.00	9003030009100
0.0360			1.50	25.00	6.00	9003030009150
0.0362			1.50	25.00	6.00	9003030009200
0.0366			1.50	25.00	6.00	9003030009300
0.0368			1.50	25.00	6.00	9003030009350
0.0370	63		1.50	25.00	6.00	9003030009400
0.0374			1.50	25.00	6.00	9003030009500
0.0378			1.50	25.00	6.80	9003030009600
0.0382	62		1.50	25.00	6.80	9003030009700
0.0386			1.50	25.00	6.80	9003030009800
0.0390	61		1.50	25.00	6.80	9003030009900
0.0394			1.50	25.00	6.80	9003030010000
0.0396			1.50	25.00	6.80	9003030010050
0.0398			1.50	25.00	6.80	9003030010100
0.0402	60		1.50	25.00	6.80	9003030010200
0.0406			1.50	25.00	6.80	9003030010300

*Items listed in red are non-stocked items, and may take 2 - 6 weeks to receive

Series 303

Speeds & Feeds information pg 431

Diameter (d1)							
Dec. inch	Fract. inch	Wire / letter	mm	d2 mm	l1 mm	l2 mm	EDP #
0.0409		59	1.040	1.500	25.00	6.80	9003030010400
0.0413			1.050	1.500	25.00	6.80	9003030010500
0.0417			1.060	1.500	25.00	6.80	9003030010600
0.0421		58	1.070	1.500	25.00	7.60	9003030010700
0.0425			1.080	1.500	25.00	7.60	9003030010800
0.0429		57	1.090	1.500	25.00	7.60	9003030010900
0.0433			1.100	1.500	25.00	7.60	9003030011000
0.0437			1.110	1.500	25.00	7.60	9003030011100
0.0441			1.120	1.500	25.00	7.60	9003030011200
0.0453			1.150	1.500	25.00	7.60	9003030011500
0.0461			1.170	1.500	25.00	7.60	9003030011700
0.0465		56	1.180	1.500	25.00	7.60	9003030011800
0.0469	3/64		1.190	1.500	25.00	8.50	9003030011900
0.0472			1.200	1.500	25.00	8.50	9003030012000
0.0480			1.220	1.500	25.00	8.50	9003030012200

Diameter (d1)							
Dec. inch	Fract. inch	Wire / letter	mm	d2 mm	l1 mm	l2 mm	EDP #
0.0492			1.250	1.500	25.00	8.50	9003030012500
0.0500			1.270	1.500	25.00	8.50	9003030012700
0.0508			1.290	1.500	25.00	8.50	9003030012900
0.0512			1.300	1.500	25.00	8.50	9003030013000
0.0520		55	1.320	1.500	25.00	8.50	9003030013200
0.0524			1.330	1.500	25.00	9.50	9003030013300
0.0531			1.350	1.500	25.00	9.50	9003030013500
0.0535			1.360	1.500	25.00	9.50	9003030013600
0.0551		54	1.400	1.500	25.00	9.50	9003030014000
0.0728		49	1.850	2.000	30.00	11.80	9003030018500

Alternative Drill Series:

#226 HSS, GT100, LH helix, 3xD, 118 pt, Bright/Steam Oxide > 6.00

5xD

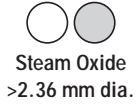

External Coolant

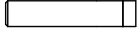

Straight Shank

Speeds & Feeds information pg 432

Series 305



General Purpose

Cobalt, general purpose (Type N), jobber length, 118° point, Form A web thinned >2.36mm dia., standard straight shank, RH helix

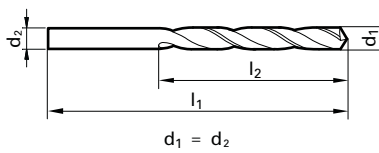
Cut / Shank Dia. = h8 tolerance range



Application Materials:

-  Universal Steels
-  Hardened Materials
-  Cast Iron

Twist Drills

Dec. inch	Diameter (d1)		l1 mm	l2 mm	EDP #	
	Fract. inch	Wire / letter				
0.0079		92	0.200	19.00	2.50	9003050002000
0.0083		91	0.210	19.00	2.50	9003050002100
0.0087		90	0.220	19.00	2.50	9003050002200
0.0091		89	0.230	19.00	2.50	9003050002300
0.0098		87	0.250	19.00	3.00	9003050002500
0.0102			0.260	19.00	3.00	9003050002600
0.0106		86	0.270	19.00	3.00	9003050002700
0.0110		85	0.280	19.00	3.00	9003050002800
0.0118			0.300	19.00	3.00	9003050003000
0.0122		83	0.310	19.00	4.00	9003050003100
0.0126		82	0.320	19.00	4.00	9003050003200
0.0130		81	0.330	19.00	4.00	9003050003300
0.0134		80	0.340	19.00	4.00	9003050003400
0.0138			0.350	19.00	4.00	9003050003500
0.0146		79	0.370	19.00	4.00	9003050003700
0.0150			0.380	19.00	4.00	9003050003800
0.0157	1/64		0.400	20.00	5.00	9003050004000
0.0161		78	0.410	20.00	5.00	9003050004100
0.0165			0.420	20.00	5.00	9003050004200
0.0169			0.430	20.00	5.00	9003050004300
0.0173			0.440	20.00	5.00	9003050004400
0.0177			0.450	20.00	5.00	9003050004500
0.0181		77	0.460	20.00	5.00	9003050004600
0.0185			0.470	20.00	5.00	9003050004700
0.0189			0.480	20.00	5.00	9003050004800
0.0193			0.490	22.00	6.00	9003050004900
0.0197			0.500	22.00	6.00	9003050005000
0.0201		76	0.510	22.00	6.00	9003050005100
0.0205			0.520	22.00	6.00	9003050005200
0.0209		75	0.530	22.00	6.00	9003050005300
0.0213			0.540	24.00	7.00	9003050005400
0.0217			0.550	24.00	7.00	9003050005500
0.0220			0.560	24.00	7.00	9003050005600
0.0224		74	0.570	24.00	7.00	9003050005700
0.0232			0.590	24.00	7.00	9003050005900
0.0236			0.600	24.00	7.00	9003050006000
0.0240		73	0.610	26.00	8.00	9003050006100
0.0244			0.620	26.00	8.00	9003050006200
0.0252		72	0.640	26.00	8.00	9003050006400
0.0256			0.650	26.00	8.00	9003050006500
0.0260		71	0.660	26.00	8.00	9003050006600
0.0264			0.670	26.00	8.00	9003050006700
0.0268			0.680	28.00	9.00	9003050006800
0.0276			0.700	28.00	9.00	9003050007000
0.0280		70	0.710	28.00	9.00	9003050007100
0.0283			0.720	28.00	9.00	9003050007200
0.0291		69	0.740	28.00	9.00	9003050007400
0.0295			0.750	28.00	9.00	9003050007500
0.0299			0.760	30.00	10.00	9003050007600
0.0303			0.770	30.00	10.00	9003050007700
0.0307			0.780	30.00	10.00	9003050007800
0.0311	1/32	68	0.790	30.00	10.00	9003050007900
0.0315			0.800	30.00	10.00	9003050008000
0.0319		67	0.810	30.00	10.00	9003050008100

Dec. inch	Diameter (d1)		l1 mm	l2 mm	EDP #	
	Fract. inch	Wire / letter				
0.0323			0.820	30.00	10.00	9003050008200
0.0331		66	0.840	30.00	10.00	9003050008400
0.0335			0.850	30.00	10.00	9003050008500
0.0339			0.860	32.00	11.00	9003050008600
0.0343			0.870	32.00	11.00	9003050008700
0.0346			0.880	32.00	11.00	9003050008800
0.0350		65	0.890	32.00	11.00	9003050008900
0.0354			0.900	32.00	11.00	9003050009000
0.0358		64	0.910	32.00	11.00	9003050009100
0.0362			0.920	32.00	11.00	9003050009200
0.0370		63	0.940	32.00	11.00	9003050009400
0.0374			0.950	32.00	11.00	9003050009500
0.0378			0.960	34.00	12.00	9003050009600
0.0382		62	0.970	34.00	12.00	9003050009700
0.0390		61	0.990	34.00	12.00	9003050009900
0.0394			1.000	34.00	12.00	9003050010000
0.0398			1.010	34.00	12.00	9003050010100
0.0402		60	1.020	34.00	12.00	9003050010200
0.0406			1.030	34.00	12.00	9003050010300
0.0409		59	1.040	34.00	12.00	9003050010400
0.0413			1.050	34.00	12.00	9003050010500
0.0421		58	1.070	36.00	14.00	9003050010700
0.0425			1.080	36.00	14.00	9003050010800
0.0429		57	1.090	36.00	14.00	9003050010900
0.0433			1.100	36.00	14.00	9003050011000
0.0449			1.140	36.00	14.00	9003050011400
0.0453			1.150	36.00	14.00	9003050011500
0.0457			1.160	36.00	14.00	9003050011600
0.0461			1.170	36.00	14.00	9003050011700
0.0465		56	1.180	36.00	14.00	9003050011800
0.0469	3/64		1.190	38.00	16.00	9003050011900
0.0472			1.200	38.00	16.00	9003050012000
0.0480			1.220	38.00	16.00	9003050012200
0.0484			1.230	38.00	16.00	9003050012300
0.0492			1.250	38.00	16.00	9003050012500
0.0508			1.290	38.00	16.00	9003050012900
0.0512			1.300	38.00	16.00	9003050013000
0.0520		55	1.320	38.00	16.00	9003050013200
0.0524			1.330	40.00	18.00	9003050013300
0.0531			1.350	40.00	18.00	9003050013500
0.0535			1.360	40.00	18.00	9003050013600
0.0539			1.370	40.00	18.00	9003050013700
0.0543			1.380	40.00	18.00	9003050013800
0.0551		54	1.400	40.00	18.00	9003050014000
0.0555			1.410	40.00	18.00	9003050014100
0.0559			1.420	40.00	18.00	9003050014200
0.0563			1.430	40.00	18.00	9003050014300
0.0567			1.440	40.00	18.00	9003050014400
0.0571			1.450	40.00	18.00	9003050014500
0.0583			1.480	40.00	18.00	9003050014800
0.0591			1.500	40.00	18.00	9003050015000
0.0594		53	1.510	43.00	20.00	9003050015100
0.0598			1.520	43.00	20.00	9003050015200
0.0602			1.530	43.00	20.00	9003050015300

*Items listed in red are non-stocked items, and may take 2 - 6 weeks to receive

Series 305

Speeds & Feeds information pg 432

Dec. inch	Diameter (d1)		l1 mm	l2 mm	EDP #	
	Fract. inch	Wire / letter				
0.5236			13.300	160.00	108.00	9003050133000
0.5311	17/32		13.490	160.00	108.00	9003050134900
0.5315			13.500	160.00	108.00	9003050135000
0.5354			13.600	160.00	108.00	9003050136000
0.5413			13.750	160.00	108.00	9003050137500
0.5433			13.800	160.00	108.00	9003050138000
0.5469	35/64		13.890	160.00	108.00	9003050138900
0.5512			14.000	160.00	108.00	9003050140000
0.5591			14.200	169.00	114.00	9003050142000
0.5626	9/16		14.290	169.00	114.00	9003050142900
0.5669			14.400	169.00	114.00	9003050144000
0.5709			14.500	169.00	114.00	9003050145000
0.5780	37/64		14.680	169.00	114.00	9003050146800
0.5807			14.750	169.00	114.00	9003050147500
0.5906			15.000	169.00	114.00	9003050150000
0.5945			15.100	178.00	120.00	9003050151000
0.6004			15.250	178.00	120.00	9003050152500
0.6024			15.300	178.00	120.00	9003050153000
0.6094	39/64		15.480	178.00	120.00	9003050154800
0.6102			15.500	178.00	120.00	9003050155000
0.6201			15.750	178.00	120.00	9003050157500
0.6248	5/8		15.870	178.00	120.00	9003050158700

Dec. inch	Diameter (d1)		l1 mm	l2 mm	EDP #	
	Fract. inch	Wire / letter				
0.6299			16.000	178.00	120.00	9003050160000
0.6496			16.500	184.00	125.00	9003050165000
0.6563	21/32		16.670	184.00	125.00	9003050166700
0.6693			17.000	184.00	125.00	9003050170000
0.6874	11/16		17.460	191.00	130.00	9003050174600
0.6890			17.500	191.00	130.00	9003050175000
0.7087			18.000	191.00	130.00	9003050180000
0.7283			18.500	198.00	135.00	9003050185000
0.7480			19.000	198.00	135.00	9003050190000
0.7677			19.500	205.00	140.00	9003050195000
0.7811	25/32		19.840	205.00	140.00	9003050198400
0.7874			20.000	205.00	140.00	9003050200000

Alternative Drill Series:

- #651 HSS, GP, 5xD, 118 pt, TiN
- #605 Cobalt, Type Ti, 5xD, 118 pt, Bright
- #5519 Cobalt, GU500, 5xD, 118 pt, TiN
- #732 Carbide, GP, 5xD, 130 pt, Bright

5xD

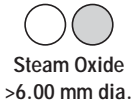

External Coolant

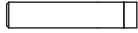

Straight Shank

Speeds & Feeds
information pg 432

Series 308

General Purpose, LH helix

Cobalt, general purpose (Type N), jobber length, 118° point,
Form A web thinned >2.36mm dia., standard straight shank, LH helix

Cut / Shank Dia. = h8 tolerance range

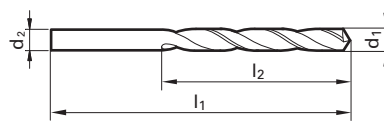

$$d_1 = d_2$$

Application Materials:



Universal Steels



Hardened Materials

Twist Drills

Diameter (d1)		Wire / letter	l1 mm	l2 mm	EDP #
Dec. inch	Fract. inch				
0.0189			20.00	5.00	9003080004800
0.0197			22.00	6.00	9003080005000
0.0295			28.00	9.00	9003080007500
0.0307			30.00	10.00	9003080007800
0.0315			30.00	10.00	9003080008000
0.0354			32.00	11.00	9003080009000
0.0358		64	32.00	11.00	9003080009100
0.0366			32.00	11.00	9003080009300
0.0386			34.00	12.00	9003080009800
0.0394			34.00	12.00	9003080010000
0.0402		60	34.00	12.00	9003080010200
0.0425			36.00	14.00	9003080010800
0.0433			36.00	14.00	9003080011000
0.0453			36.00	14.00	9003080011500
0.0465		56	36.00	14.00	9003080011800
0.0469	3/64		38.00	16.00	9003080011900
0.0472			38.00	16.00	9003080012000
0.0492			38.00	16.00	9003080012500
0.0512			38.00	16.00	9003080013000
0.0520		55	38.00	16.00	9003080013200
0.0531			40.00	18.00	9003080013500
0.0551		54	40.00	18.00	9003080014000
0.0563			40.00	18.00	9003080014300
0.0571			40.00	18.00	9003080014500
0.0579			40.00	18.00	9003080014700
0.0587			40.00	18.00	9003080014900
0.0591			40.00	18.00	9003080015000
0.0594		53	43.00	20.00	9003080015100
0.0610			43.00	20.00	9003080015500
0.0626	1/16		43.00	20.00	9003080015900
0.0630			43.00	20.00	9003080016000
0.0661			43.00	20.00	9003080016800
0.0669		51	43.00	20.00	9003080017000
0.0677			46.00	22.00	9003080017200
0.0689			46.00	22.00	9003080017500
0.0701		50	46.00	22.00	9003080017800
0.0709			46.00	22.00	9003080018000
0.0728		49	46.00	22.00	9003080018500
0.0748			46.00	22.00	9003080019000
0.0760		48	49.00	24.00	9003080019300
0.0768			49.00	24.00	9003080019500
0.0780	5/64		49.00	24.00	9003080019800
0.0787			49.00	24.00	9003080020000
0.0811		46	49.00	24.00	9003080020600
0.0819		45	49.00	24.00	9003080020800
0.0827			49.00	24.00	9003080021000
0.0858		44	53.00	27.00	9003080021800
0.0866			53.00	27.00	9003080022000
0.0886			53.00	27.00	9003080022500
0.0890		43	53.00	27.00	9003080022600
0.0906			53.00	27.00	9003080023000
0.0925			53.00	27.00	9003080023500
0.0933		42	57.00	30.00	9003080023700
0.0937	3/32		57.00	30.00	9003080023800

Diameter (d1)		Wire / letter	l1 mm	l2 mm	EDP #
Dec. inch	Fract. inch				
0.0945			57.00	30.00	9003080024000
0.0980		40	2.490	57.00	9003080024900
0.0984			2.500	57.00	9003080025000
0.0996		39	2.530	57.00	9003080025300
0.1024			2.600	57.00	9003080026000
0.1039		37	2.640	57.00	9003080026400
0.1063			2.700	61.00	9003080027000
0.1083			2.750	61.00	9003080027500
0.1094	7/64		2.780	61.00	9003080027800
0.1098		35	2.790	61.00	9003080027900
0.1102			2.800	61.00	9003080028000
0.1110		34	2.820	61.00	9003080028200
0.1142			2.900	61.00	9003080029000
0.1161		32	2.950	61.00	9003080029500
0.1181			3.000	61.00	9003080030000
0.1201		31	3.050	65.00	9003080030500
0.1220			3.100	65.00	9003080031000
0.1248	1/8		3.170	65.00	9003080031700
0.1260			3.200	65.00	9003080032000
0.1299			3.300	65.00	9003080033000
0.1339			3.400	70.00	9003080034000
0.1358		29	3.450	70.00	9003080034500
0.1378			3.500	70.00	9003080035000
0.1417			3.600	70.00	9003080036000
0.1437			3.650	70.00	9003080036500
0.1441		27	3.660	70.00	9003080036600
0.1457			3.700	70.00	9003080037000
0.1469		26	3.730	70.00	9003080037300
0.1496		25	3.800	75.00	9003080038000
0.1520		24	3.860	75.00	9003080038600
0.1535			3.900	75.00	9003080039000
0.1539		23	3.910	75.00	9003080039100
0.1563	5/32		3.970	75.00	9003080039700
0.1571		22	3.990	75.00	9003080039900
0.1575			4.000	75.00	9003080040000
0.1591		21	4.040	75.00	9003080040400
0.1594			4.050	75.00	9003080040500
0.1610		20	4.090	75.00	9003080040900
0.1614			4.100	75.00	9003080041000
0.1634			4.150	75.00	9003080041500
0.1654			4.200	75.00	9003080042000
0.1661		19	4.220	75.00	9003080042200
0.1693		18	4.300	80.00	9003080043000
0.1720	11/64		4.370	80.00	9003080043700
0.1728		17	4.390	80.00	9003080043900
0.1732			4.400	80.00	9003080044000
0.1772		16	4.500	80.00	9003080045000
0.1811			4.600	80.00	9003080046000
0.1819		14	4.620	80.00	9003080046200
0.1850		13	4.700	80.00	9003080047000
0.1874	3/16		4.760	86.00	9003080047600
0.1890		12	4.800	86.00	9003080048000
0.1929			4.900	86.00	9003080049000
0.1961		9	4.980	86.00	9003080049800

*Items listed in red are non-stocked items, and may take 2 - 6 weeks to receive

Series 308

Speeds & Feeds information pg 432

Twist Drills

Diameter (d1)		Wire / letter	l1 mm	l2 mm	EDP #	
Dec. inch	Fract. inch					mm
0.1969			5.000	86.00	52.00	9003080050000
0.1992		8	5.060	86.00	52.00	9003080050600
0.2008			5.100	86.00	52.00	9003080051000
0.2012		7	5.110	86.00	52.00	9003080051100
0.2031	13/64		5.160	86.00	52.00	9003080051600
0.2039		6	5.180	86.00	52.00	9003080051800
0.2047			5.200	86.00	52.00	9003080052000
0.2055		5	5.220	86.00	52.00	9003080052200
0.2087			5.300	86.00	52.00	9003080053000
0.2091		4	5.310	93.00	57.00	9003080053100
0.2126			5.400	93.00	57.00	9003080054000
0.2130		3	5.410	93.00	57.00	9003080054100
0.2165			5.500	93.00	57.00	9003080055000
0.2189	7/32		5.560	93.00	57.00	9003080055600
0.2205			5.600	93.00	57.00	9003080056000
0.2209		2	5.610	93.00	57.00	9003080056100
0.2244			5.700	93.00	57.00	9003080057000
0.2283			5.800	93.00	57.00	9003080058000
0.2339		A	5.940	93.00	57.00	9003080059400
0.2343	15/64		5.950	93.00	57.00	9003080059500
0.2362			6.000	93.00	57.00	9003080060000
0.2402			6.100	101.00	63.00	9003080061000
0.2421		C	6.150	101.00	63.00	9003080061500
0.2441			6.200	101.00	63.00	9003080062000
0.2461		D	6.250	101.00	63.00	9003080062500
0.2480			6.300	101.00	63.00	9003080063000
0.2500	1/4	E	6.350	101.00	63.00	9003080063500
0.2559			6.500	101.00	63.00	9003080065000
0.2598			6.600	101.00	63.00	9003080066000
0.2638			6.700	101.00	63.00	9003080067000
0.2657	17/64	H	6.750	109.00	69.00	9003080067500
0.2677			6.800	109.00	69.00	9003080068000
0.2756			7.000	109.00	69.00	9003080070000
0.2902		L	7.370	109.00	69.00	9003080073700
0.2913			7.400	109.00	69.00	9003080074000
0.2953			7.500	109.00	69.00	9003080075000
0.2969	19/64		7.540	117.00	75.00	9003080075400
0.2992			7.600	117.00	75.00	9003080076000
0.3031			7.700	117.00	75.00	9003080077000
0.3110			7.900	117.00	75.00	9003080079000
0.3150			8.000	117.00	75.00	9003080080000
0.3161		O	8.030	117.00	75.00	9003080080300
0.3189			8.100	117.00	75.00	9003080081000
0.3228		P	8.200	117.00	75.00	9003080082000

Diameter (d1)		Wire / letter	l1 mm	l2 mm	EDP #	
Dec. inch	Fract. inch					mm
0.3268			8.300	117.00	75.00	9003080083000
0.3280	21/64		8.330	117.00	75.00	9003080083300
0.3346			8.500	117.00	75.00	9003080085000
0.3386			8.600	125.00	81.00	9003080086000
0.3390		R	8.610	125.00	81.00	9003080086100
0.3425			8.700	125.00	81.00	9003080087000
0.3437	11/32		8.730	125.00	81.00	9003080087300
0.3465			8.800	125.00	81.00	9003080088000
0.3480		S	8.840	125.00	81.00	9003080088400
0.3504			8.900	125.00	81.00	9003080089000
0.3543			9.000	125.00	81.00	9003080090000
0.3579		T	9.090	125.00	81.00	9003080090900
0.3583			9.100	125.00	81.00	9003080091000
0.3594	23/64		9.130	125.00	81.00	9003080091300
0.3622			9.200	125.00	81.00	9003080092000
0.3661			9.300	125.00	81.00	9003080093000
0.3677		U	9.340	125.00	81.00	9003080093400
0.3701			9.400	125.00	81.00	9003080094000
0.3740			9.500	125.00	81.00	9003080095000
0.3748	3/8		9.520	133.00	87.00	9003080095200
0.3772		V	9.580	133.00	87.00	9003080095800
0.3780			9.600	133.00	87.00	9003080096000
0.3819			9.700	133.00	87.00	9003080097000
0.3858		W	9.800	133.00	87.00	9003080098000
0.3898			9.900	133.00	87.00	9003080099000
0.3906	25/64		9.920	133.00	87.00	9003080099200
0.3937			10.000	133.00	87.00	9003080100000
0.4039		Y	10.260	133.00	87.00	9003080102600
0.4063	13/32		10.320	133.00	87.00	9003080103200
0.4130		Z	10.490	133.00	87.00	9003080104900
0.4134			10.500	133.00	87.00	9003080105000
0.4331			11.000	142.00	94.00	9003080110000
0.4374	7/16		11.110	142.00	94.00	9003080111100
0.4528			11.500	142.00	94.00	9003080115000
0.4531	29/64		11.510	142.00	94.00	9003080115100
0.4689	15/32		11.910	151.00	101.00	9003080119100
0.4744			12.050	151.00	101.00	9003080120500
0.4921			12.500	151.00	101.00	9003080125000
0.5000	1/2		12.700	151.00	101.00	9003080127000

Alternative Drill Series:

#208 HSS, GP, LH Helix, 5xD, 118 pt, Bright/Steam Oxide > 6.00

10xD

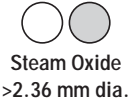

Speeds & Feeds
information pg 433

Series 317

General Purpose

Cobalt, general purpose (Type N), taper length, 118° point, Form A web thinned >2.36mm dia., standard straight shank, RH helix

Cut / Shank Dia. = h8 tolerance range

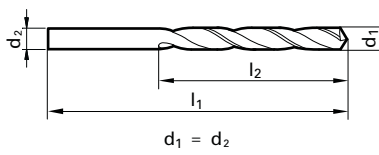

Application Materials:

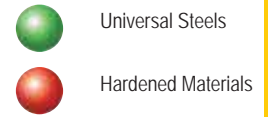

Twist Drills

Dec. inch	Diameter (d1)		I1 mm	I2 mm	EDP #
	Fract. inch	Wire / letter			
0.0197			32.00	12.00	9003170005000
0.0256			38.00	18.00	9003170006500
0.0276			42.00	21.00	9003170007000
0.0295			42.00	21.00	9003170007500
0.0315			46.00	25.00	9003170008000
0.0335			46.00	25.00	9003170008500
0.0354			51.00	29.00	9003170009000
0.0374			51.00	29.00	9003170009500
0.0394			56.00	33.00	9003170010000
0.0402		60	56.00	33.00	9003170010200
0.0433			60.00	37.00	9003170011000
0.0469	3/64		65.00	41.00	9003170011900
0.0472			65.00	41.00	9003170012000
0.0492			65.00	41.00	9003170012500
0.0512			65.00	41.00	9003170013000
0.0551		54	70.00	45.00	9003170014000
0.0591			70.00	45.00	9003170015000
0.0594		53	76.00	50.00	9003170015100
0.0610			76.00	50.00	9003170015500
0.0626	1/16		76.00	50.00	9003170015900
0.0630			76.00	50.00	9003170016000
0.0650			76.00	50.00	9003170016500
0.0669		51	76.00	50.00	9003170017000
0.0701		50	80.00	53.00	9003170017800
0.0709			80.00	53.00	9003170018000
0.0748			80.00	53.00	9003170019000
0.0768			85.00	56.00	9003170019500
0.0780	5/64		85.00	56.00	9003170019800
0.0787			85.00	56.00	9003170020000
0.0807			85.00	56.00	9003170020500
0.0827			85.00	56.00	9003170021000
0.0866			90.00	59.00	9003170022000
0.0906			90.00	59.00	9003170023000
0.0937	3/32		95.00	62.00	9003170023800
0.0945			95.00	62.00	9003170024000
0.0965			95.00	62.00	9003170024500
0.0984			95.00	62.00	9003170025000
0.1024			95.00	62.00	9003170026000
0.1063			100.00	66.00	9003170027000
0.1094	7/64		100.00	66.00	9003170027800
0.1102			100.00	66.00	9003170028000
0.1142			100.00	66.00	9003170029000
0.1181			100.00	66.00	9003170030000
0.1201		31	106.00	69.00	9003170030500
0.1220			106.00	69.00	9003170031000
0.1248	1/8		106.00	69.00	9003170031700
0.1260			106.00	69.00	9003170032000
0.1280			106.00	69.00	9003170032500
0.1299			106.00	69.00	9003170033000
0.1339			112.00	73.00	9003170034000
0.1358		29	112.00	73.00	9003170034500
0.1378			112.00	73.00	9003170035000
0.1417			112.00	73.00	9003170036000
0.1457			112.00	73.00	9003170037000

Dec. inch	Diameter (d1)		I1 mm	I2 mm	EDP #	
	Fract. inch	Wire / letter				
0.1496		25	3.800	119.00	78.00	9003170038000
0.1535			3.900	119.00	78.00	9003170039000
0.1563	5/32		3.970	119.00	78.00	9003170039700
0.1575			4.000	119.00	78.00	9003170040000
0.1614			4.100	119.00	78.00	9003170041000
0.1654			4.200	119.00	78.00	9003170042000
0.1693		18	4.300	126.00	82.00	9003170043000
0.1720	11/64		4.370	126.00	82.00	9003170043700
0.1732			4.400	126.00	82.00	9003170044000
0.1772		16	4.500	126.00	82.00	9003170045000
0.1811			4.600	126.00	82.00	9003170046000
0.1850		13	4.700	126.00	82.00	9003170047000
0.1874	3/16		4.760	132.00	87.00	9003170047600
0.1890		12	4.800	132.00	87.00	9003170048000
0.1909		11	4.850	132.00	87.00	9003170048500
0.1929			4.900	132.00	87.00	9003170049000
0.1969			5.000	132.00	87.00	9003170050000
0.2008			5.100	132.00	87.00	9003170051000
0.2031	13/64		5.160	132.00	87.00	9003170051600
0.2047			5.200	132.00	87.00	9003170052000
0.2087			5.300	132.00	87.00	9003170053000
0.2126			5.400	139.00	91.00	9003170054000
0.2165			5.500	139.00	91.00	9003170055000
0.2189	7/32		5.560	139.00	91.00	9003170055600
0.2205			5.600	139.00	91.00	9003170056000
0.2244			5.700	139.00	91.00	9003170057000
0.2283			5.800	139.00	91.00	9003170058000
0.2323			5.900	139.00	91.00	9003170059000
0.2343	15/64		5.950	139.00	91.00	9003170059500
0.2362			6.000	139.00	91.00	9003170060000
0.2402			6.100	148.00	97.00	9003170061000
0.2441			6.200	148.00	97.00	9003170062000
0.2480			6.300	148.00	97.00	9003170063000
0.2500	1/4	E	6.350	148.00	97.00	9003170063500
0.2520			6.400	148.00	97.00	9003170064000
0.2559			6.500	148.00	97.00	9003170065000
0.2598			6.600	148.00	97.00	9003170066000
0.2610		G	6.630	148.00	97.00	9003170066300
0.2638			6.700	148.00	97.00	9003170067000
0.2657	17/64	H	6.750	156.00	102.00	9003170067500
0.2677			6.800	156.00	102.00	9003170068000
0.2717		I	6.900	156.00	102.00	9003170069000
0.2756			7.000	156.00	102.00	9003170070000
0.2811	9/32	K	7.140	156.00	102.00	9003170071400
0.2835			7.200	156.00	102.00	9003170072000
0.2874			7.300	156.00	102.00	9003170073000
0.2913			7.400	156.00	102.00	9003170074000
0.2953			7.500	156.00	102.00	9003170075000
0.2969	19/64		7.540	165.00	109.00	9003170075400
0.2992			7.600	165.00	109.00	9003170076000
0.3031			7.700	165.00	109.00	9003170077000
0.3071			7.800	165.00	109.00	9003170078000
0.3110			7.900	165.00	109.00	9003170079000
0.3126	5/16		7.940	165.00	109.00	9003170079400

*Items listed in red are non-stocked items, and may take 2 - 6 weeks to receive

Series 317

Speeds & Feeds information pg 433

Twist Drills

Dec. inch	Diameter (d1)		I1 mm	I2 mm	EDP #	
	Fract. inch	Wire / letter				
0.3150			8.000	165.00	109.00	9003170080000
0.3189			8.100	165.00	109.00	9003170081000
0.3228		P	8.200	165.00	109.00	9003170082000
0.3280	21/64		8.330	165.00	109.00	9003170083300
0.3307			8.400	165.00	109.00	9003170084000
0.3346			8.500	165.00	109.00	9003170085000
0.3386			8.600	175.00	115.00	9003170086000
0.3425			8.700	175.00	115.00	9003170087000
0.3437	11/32		8.730	175.00	115.00	9003170087300
0.3465			8.800	175.00	115.00	9003170088000
0.3543			9.000	175.00	115.00	9003170090000
0.3583			9.100	175.00	115.00	9003170091000
0.3594	23/64		9.130	175.00	115.00	9003170091300
0.3622			9.200	175.00	115.00	9003170092000
0.3661			9.300	175.00	115.00	9003170093000
0.3701			9.400	175.00	115.00	9003170094000
0.3740			9.500	175.00	115.00	9003170095000
0.3748	3/8		9.520	184.00	121.00	9003170095200
0.3780			9.600	184.00	121.00	9003170096000
0.3819			9.700	184.00	121.00	9003170097000
0.3858		W	9.800	184.00	121.00	9003170098000
0.3898			9.900	184.00	121.00	9003170099000
0.3906	25/64		9.920	184.00	121.00	9003170099200
0.3937			10.000	184.00	121.00	9003170100000
0.3976			10.100	184.00	121.00	9003170101000
0.4016			10.200	184.00	121.00	9003170102000
0.4063	13/32		10.320	184.00	121.00	9003170103200
0.4134			10.500	184.00	121.00	9003170105000

Dec. inch	Diameter (d1)		I1 mm	I2 mm	EDP #	
	Fract. inch	Wire / letter				
0.4220	27/64		10.720	195.00	128.00	9003170107200
0.4331			11.000	195.00	128.00	9003170110000
0.4374	7/16		11.110	195.00	128.00	9003170111100
0.4409			11.200	195.00	128.00	9003170112000
0.4528			11.500	195.00	128.00	9003170115000
0.4531	29/64		11.510	195.00	128.00	9003170115100
0.4646			11.800	195.00	128.00	9003170118000
0.4689	15/32		11.910	205.00	134.00	9003170119100
0.4724			12.000	205.00	134.00	9003170120000
0.4843	31/64		12.300	205.00	134.00	9003170123000
0.4921			12.500	205.00	134.00	9003170125000
0.5000	1/2		12.700	205.00	134.00	9003170127000
0.5118			13.000	205.00	134.00	9003170130000
0.5157	33/64		13.100	205.00	134.00	9003170131000
0.5311	17/32		13.490	214.00	140.00	9003170134900
0.5315			13.500	214.00	140.00	9003170135000
0.5512			14.000	214.00	140.00	9003170140000
0.5626	9/16		14.290	220.00	144.00	9003170142900
0.5906			15.000	220.00	144.00	9003170150000
0.6094	39/64		15.480	227.00	149.00	9003170154800
0.6248	5/8		15.870	227.00	149.00	9003170158700
0.6299			16.000	227.00	149.00	9003170160000

Alternative Drill Series:

#217 HSS, GP, 10xD, 118 pt, Bright/Steam Oxide > 2.36
 #667 HSS, GP, 10xD, 118 pt, TiN

Series 329

Speeds & Feeds information pg 433

Twist Drills

Dec. inch	Diameter (d1)			I1 mm	I2 mm	EDP #
	Fract. inch	Wire / letter	mm			
0.3445			8.750	84.00	40.00	9003290087500
0.3465			8.800	84.00	40.00	9003290088000
0.3480		S	8.840	84.00	40.00	9003290088400
0.3504			8.900	84.00	40.00	9003290089000
0.3543			9.000	84.00	40.00	9003290090000
0.3563			9.050	84.00	40.00	9003290090500
0.3579		T	9.090	84.00	40.00	9003290090900
0.3583			9.100	84.00	40.00	9003290091000
0.3594	23/64		9.130	84.00	40.00	9003290091300
0.3622			9.200	84.00	40.00	9003290092000
0.3642			9.250	84.00	40.00	9003290092500
0.3661			9.300	84.00	40.00	9003290093000
0.3677		U	9.340	84.00	40.00	9003290093400
0.3701			9.400	84.00	40.00	9003290094000
0.3740			9.500	84.00	40.00	9003290095000
0.3748	3/8		9.520	89.00	43.00	9003290095200
0.3772		V	9.580	89.00	43.00	9003290095800
0.3780			9.600	89.00	43.00	9003290096000
0.3819			9.700	89.00	43.00	9003290097000
0.3839			9.750	89.00	43.00	9003290097500
0.3858		W	9.800	89.00	43.00	9003290098000
0.3898			9.900	89.00	43.00	9003290099000
0.3906	25/64		9.920	89.00	43.00	9003290099200
0.3937			10.000	89.00	43.00	9003290100000
0.3969		X	10.080	89.00	43.00	9003290100800
0.3976			10.100	89.00	43.00	9003290101000
0.4016			10.200	89.00	43.00	9003290102000
0.4039		Y	10.260	89.00	43.00	9003290102600
0.4055			10.300	89.00	43.00	9003290103000
0.4063	13/32		10.320	89.00	43.00	9003290103200
0.4094			10.400	89.00	43.00	9003290104000
0.4130		Z	10.490	89.00	43.00	9003290104900
0.4134			10.500	89.00	43.00	9003290105000
0.4173			10.600	89.00	43.00	9003290106000
0.4193			10.650	95.00	47.00	9003290106500
0.4220	27/64		10.720	95.00	47.00	9003290107200
0.4252			10.800	95.00	47.00	9003290108000
0.4291			10.900	95.00	47.00	9003290109000
0.4331			11.000	95.00	47.00	9003290110000
0.4370			11.100	95.00	47.00	9003290111000
0.4374	7/16		11.110	95.00	47.00	9003290111100
0.4409			11.200	95.00	47.00	9003290112000
0.4429			11.250	95.00	47.00	9003290112500
0.4449			11.300	95.00	47.00	9003290113000
0.4488			11.400	95.00	47.00	9003290114000
0.4528			11.500	95.00	47.00	9003290115000
0.4531	29/64		11.510	95.00	47.00	9003290115100
0.4567			11.600	95.00	47.00	9003290116000
0.4606			11.700	95.00	47.00	9003290117000
0.4646			11.800	95.00	47.00	9003290118000
0.4689	15/32		11.910	102.00	51.00	9003290119100
0.4724			12.000	102.00	51.00	9003290120000
0.4764			12.100	102.00	51.00	9003290121000
0.4803			12.200	102.00	51.00	9003290122000
0.4843	31/64		12.300	102.00	51.00	9003290123000
0.4882			12.400	102.00	51.00	9003290124000
0.4921			12.500	102.00	51.00	9003290125000
0.5000	1/2		12.700	102.00	51.00	9003290127000

Dec. inch	Diameter (d1)			I1 mm	I2 mm	EDP #
	Fract. inch	Wire / letter	mm			
0.5039			12.800	102.00	51.00	9003290128000
0.5079			12.900	102.00	51.00	9003290129000
0.5118			13.000	102.00	51.00	9003290130000
0.5157	33/64		13.100	102.00	51.00	9003290131000
0.5197			13.200	102.00	51.00	9003290132000
0.5311	17/32		13.490	107.00	54.00	9003290134900
0.5315			13.500	107.00	54.00	9003290135000
0.5413			13.750	107.00	54.00	9003290137500
0.5469	35/64		13.890	107.00	54.00	9003290138900
0.5512			14.000	107.00	54.00	9003290140000
0.5551			14.100	111.00	56.00	9003290141000
0.5626	9/16		14.290	111.00	56.00	9003290142900
0.5709			14.500	111.00	56.00	9003290145000
0.5780	37/64		14.680	111.00	56.00	9003290146800
0.5807			14.750	111.00	56.00	9003290147500
0.5906			15.000	111.00	56.00	9003290150000
0.5937	19/32		15.080	115.00	58.00	9003290150800
0.6004			15.250	115.00	58.00	9003290152500
0.6094	39/64		15.480	115.00	58.00	9003290154800
0.6102			15.500	115.00	58.00	9003290155000
0.6248	5/8		15.870	115.00	58.00	9003290158700
0.6299			16.000	115.00	58.00	9003290160000
0.6378			16.200	119.00	60.00	9003290162000
0.6406	41/64		16.270	119.00	60.00	9003290162700
0.6496			16.500	119.00	60.00	9003290165000
0.6563	21/32		16.670	119.00	60.00	9003290166700
0.6693			17.000	119.00	60.00	9003290170000
0.6720	43/64		17.070	123.00	62.00	9003290170700
0.6874	11/16		17.460	123.00	62.00	9003290174600
0.6890			17.500	123.00	62.00	9003290175000
0.7031	45/64		17.860	123.00	62.00	9003290178600
0.7087			18.000	123.00	62.00	9003290180000
0.7283			18.500	127.00	64.00	9003290185000
0.7343	47/64		18.650	127.00	64.00	9003290186500
0.7480			19.000	127.00	64.00	9003290190000
0.7500	3/4		19.050	131.00	66.00	9003290190500
0.7657	49/64		19.450	131.00	66.00	9003290194500
0.7677			19.500	131.00	66.00	9003290195000
0.7811	25/32		19.840	131.00	66.00	9003290198400
0.7874			20.000	131.00	66.00	9003290200000
0.7972			20.250	136.00	68.00	9003290202500
0.8071			20.500	136.00	68.00	9003290205000
0.8126	13/16		20.640	136.00	68.00	9003290206400
0.8268			21.000	136.00	68.00	9003290210000
0.8465			21.500	141.00	70.00	9003290215000
0.8661			22.000	141.00	70.00	9003290220000
0.8740			22.200	141.00	70.00	9003290222000
0.9055			23.000	146.00	72.00	9003290230000
0.9449			24.000	151.00	75.00	9003290240000
0.9646			24.500	151.00	75.00	9003290245000
0.9843	63/64		25.000	151.00	75.00	9003290250000
1.0000	1		25.400	156.00	78.00	9003290254000

Alternative Drill Series:

#659 Cobalt, GV120, 3xD, 130 pt, TiN
 #5524 Cobalt, GU500, 3xD, 118 pt, Bright

*Items listed in red are non-stocked items, and may take 2 - 6 weeks to receive

10xD



Nitrided lands/polished flutes >2.36mm dia.



External Coolant

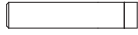

Straight Shank

Speeds & Feeds information pg 434

Series 336

GT100 Parabolic

Cobalt, GT 100 deep hole, taper length, 130° point, Form A web thinned all dia., standard straight shank, RH helix

Cut / Shank Dia. = h8 tolerance range

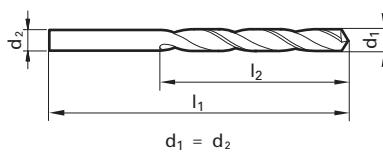

Application Materials:

- Universal Steels
- Stainless Steels
- Hardened Materials
- Cast Iron

Dec. inch	Diameter (d1)		l1 mm	l2 mm	EDP #
	Fract. inch	Wire / letter			
0.0394			56.00	33.00	9003360010000
0.0402		60	56.00	33.00	9003360010200
0.0409		59	56.00	33.00	9003360010400
0.0421		58	60.00	37.00	9003360010700
0.0429		57	60.00	37.00	9003360010900
0.0433			60.00	37.00	9003360011000
0.0465		56	60.00	37.00	9003360011800
0.0469	3/64		65.00	41.00	9003360011900
0.0472			65.00	41.00	9003360012000
0.0492			65.00	41.00	9003360012500
0.0512			65.00	41.00	9003360013000
0.0520		55	65.00	41.00	9003360013200
0.0551		54	70.00	45.00	9003360014000
0.0591			70.00	45.00	9003360015000
0.0594		53	76.00	50.00	9003360015100
0.0610			76.00	50.00	9003360015500
0.0626	1/16		76.00	50.00	9003360015900
0.0630			76.00	50.00	9003360016000
0.0634		52	76.00	50.00	9003360016100
0.0669		51	76.00	50.00	9003360017000
0.0689			80.00	53.00	9003360017500
0.0701		50	80.00	53.00	9003360017800
0.0709			80.00	53.00	9003360018000
0.0728		49	80.00	53.00	9003360018500
0.0748			80.00	53.00	9003360019000
0.0760		48	85.00	56.00	9003360019300
0.0780	5/64		85.00	56.00	9003360019800
0.0783		47	85.00	56.00	9003360019900
0.0787			85.00	56.00	9003360020000
0.0807			85.00	56.00	9003360020500
0.0811		46	85.00	56.00	9003360020600
0.0819		45	85.00	56.00	9003360020800
0.0827			85.00	56.00	9003360021000
0.0858		44	90.00	59.00	9003360021800
0.0866			90.00	59.00	9003360022000
0.0886			90.00	59.00	9003360022500
0.0890		43	90.00	59.00	9003360022600
0.0906			90.00	59.00	9003360023000
0.0925			90.00	59.00	9003360023500
0.0933		42	95.00	62.00	9003360023700
0.0937	3/32		95.00	62.00	9003360023800
0.0945			95.00	62.00	9003360024000
0.0961		41	95.00	62.00	9003360024400
0.0965			95.00	62.00	9003360024500
0.0980		40	95.00	62.00	9003360024900
0.0984			95.00	62.00	9003360025000
0.0996		39	95.00	62.00	9003360025300
0.1004			95.00	62.00	9003360025500
0.1016		38	95.00	62.00	9003360025800
0.1024			95.00	62.00	9003360026000
0.1039		37	95.00	62.00	9003360026400
0.1063			100.00	66.00	9003360027000
0.1067		36	100.00	66.00	9003360027100
0.1083			100.00	66.00	9003360027500

Dec. inch	Diameter (d1)		l1 mm	l2 mm	EDP #
	Fract. inch	Wire / letter			
0.1094	7/64		100.00	66.00	9003360027800
0.1098		35	100.00	66.00	9003360027900
0.1102			100.00	66.00	9003360028000
0.1110		34	100.00	66.00	9003360028200
0.1122			100.00	66.00	9003360028500
0.1130		33	100.00	66.00	9003360028700
0.1142			100.00	66.00	9003360029000
0.1161		32	100.00	66.00	9003360029500
0.1181			100.00	66.00	9003360030000
0.1201		31	106.00	69.00	9003360030500
0.1220			106.00	69.00	9003360031000
0.1248	1/8		106.00	69.00	9003360031700
0.1260			106.00	69.00	9003360032000
0.1283		30	106.00	69.00	9003360032600
0.1299			106.00	69.00	9003360033000
0.1339			112.00	73.00	9003360034000
0.1354			112.00	73.00	9003360034400
0.1358		29	112.00	73.00	9003360034500
0.1378			112.00	73.00	9003360035000
0.1406	9/64	28	112.00	73.00	9003360035700
0.1417			112.00	73.00	9003360036000
0.1441		27	112.00	73.00	9003360036600
0.1457			112.00	73.00	9003360037000
0.1469		26	112.00	73.00	9003360037300
0.1496		25	119.00	78.00	9003360038000
0.1520		24	119.00	78.00	9003360038600
0.1535			119.00	78.00	9003360039000
0.1539		23	119.00	78.00	9003360039100
0.1563	5/32		119.00	78.00	9003360039700
0.1571		22	119.00	78.00	9003360039900
0.1575			119.00	78.00	9003360040000
0.1591		21	119.00	78.00	9003360040400
0.1610		20	119.00	78.00	9003360040900
0.1614			119.00	78.00	9003360041000
0.1654			119.00	78.00	9003360042000
0.1661		19	119.00	78.00	9003360042200
0.1693		18	126.00	82.00	9003360043000
0.1720	11/64		126.00	82.00	9003360043700
0.1728		17	126.00	82.00	9003360043900
0.1732			126.00	82.00	9003360044000
0.1772		16	126.00	82.00	9003360045000
0.1799		15	126.00	82.00	9003360045700
0.1811			126.00	82.00	9003360046000
0.1819		14	126.00	82.00	9003360046200
0.1850		13	126.00	82.00	9003360047000
0.1874	3/16		132.00	87.00	9003360047600
0.1890		12	132.00	87.00	9003360048000
0.1909		11	132.00	87.00	9003360048500
0.1929			132.00	87.00	9003360049000
0.1937		10	132.00	87.00	9003360049200
0.1961		9	132.00	87.00	9003360049800
0.1969			132.00	87.00	9003360050000
0.1992		8	132.00	87.00	9003360050600
0.2008			132.00	87.00	9003360051000

Series 336

Speeds & Feeds information pg 434

Twist Drills

Dec. inch	Diameter (d1)		l1 mm	l2 mm	EDP #	
	Fract. inch	Wire / letter				
0.2012		7	5.110	132.00	9003360051100	
0.2031	13/64		5.160	132.00	9003360051600	
0.2039		6	5.180	132.00	9003360051800	
0.2047			5.200	132.00	9003360052000	
0.2055		5	5.220	132.00	9003360052200	
0.2087			5.300	132.00	9003360053000	
0.2091		4	5.310	139.00	91.00	9003360053100
0.2126			5.400	139.00	91.00	9003360054000
0.2130		3	5.410	139.00	91.00	9003360054100
0.2165			5.500	139.00	91.00	9003360055000
0.2189	7/32		5.560	139.00	91.00	9003360055600
0.2205			5.600	139.00	91.00	9003360056000
0.2244			5.700	139.00	91.00	9003360057000
0.2280		1	5.790	139.00	91.00	9003360057900
0.2283			5.800	139.00	91.00	9003360058000
0.2323			5.900	139.00	91.00	9003360059000
0.2343	15/64		5.950	139.00	91.00	9003360059500
0.2362			6.000	139.00	91.00	9003360060000
0.2378		B	6.040	148.00	97.00	9003360060400
0.2402			6.100	148.00	97.00	9003360061000
0.2421		C	6.150	148.00	97.00	9003360061500
0.2441			6.200	148.00	97.00	9003360062000
0.2461		D	6.250	148.00	97.00	9003360062500
0.2480			6.300	148.00	97.00	9003360063000
0.2500	1/4	E	6.350	148.00	97.00	9003360063500
0.2520			6.400	148.00	97.00	9003360064000
0.2559			6.500	148.00	97.00	9003360065000
0.2571		F	6.530	148.00	97.00	9003360065300
0.2598			6.600	148.00	97.00	9003360066000
0.2610		G	6.630	148.00	97.00	9003360066300
0.2638			6.700	148.00	97.00	9003360067000
0.2657	17/64	H	6.750	156.00	102.00	9003360067500
0.2677			6.800	156.00	102.00	9003360068000
0.2717		I	6.900	156.00	102.00	9003360069000
0.2756			7.000	156.00	102.00	9003360070000
0.2768		J	7.030	156.00	102.00	9003360070300
0.2795			7.100	156.00	102.00	9003360071000
0.2811	9/32	K	7.140	156.00	102.00	9003360071400
0.2835			7.200	156.00	102.00	9003360072000
0.2874			7.300	156.00	102.00	9003360073000
0.2913			7.400	156.00	102.00	9003360074000
0.2953			7.500	156.00	102.00	9003360075000
0.2969	19/64		7.540	165.00	109.00	9003360075400
0.3020		N	7.670	165.00	109.00	9003360076700
0.3031			7.700	165.00	109.00	9003360077000

Dec. inch	Diameter (d1)		l1 mm	l2 mm	EDP #	
	Fract. inch	Wire / letter				
0.3071			7.800	165.00	109.00	9003360078000
0.3110			7.900	165.00	109.00	9003360079000
0.3126	5/16		7.940	165.00	109.00	9003360079400
0.3150			8.000	165.00	109.00	9003360080000
0.3161		O	8.030	165.00	109.00	9003360080300
0.3189			8.100	165.00	109.00	9003360081000
0.3228		P	8.200	165.00	109.00	9003360082000
0.3268			8.300	165.00	109.00	9003360083000
0.3307			8.400	165.00	109.00	9003360084000
0.3346			8.500	165.00	109.00	9003360085000
0.3386			8.600	175.00	115.00	9003360086000
0.3390		R	8.610	175.00	115.00	9003360086100
0.3425			8.700	175.00	115.00	9003360087000
0.3437	11/32		8.730	175.00	115.00	9003360087300
0.3465			8.800	175.00	115.00	9003360088000
0.3480		S	8.840	175.00	115.00	9003360088400
0.3504			8.900	175.00	115.00	9003360089000
0.3543			9.000	175.00	115.00	9003360090000
0.3579		T	9.090	175.00	115.00	9003360090900
0.3583			9.100	175.00	115.00	9003360091000
0.3622			9.200	175.00	115.00	9003360092000
0.3661			9.300	175.00	115.00	9003360093000
0.3677		U	9.340	175.00	115.00	9003360093400
0.3701			9.400	175.00	115.00	9003360094000
0.3740			9.500	175.00	115.00	9003360095000
0.3748	3/8		9.520	184.00	121.00	9003360095200
0.3819			9.700	184.00	121.00	9003360097000
0.3839			9.750	184.00	121.00	9003360097500
0.3858		W	9.800	184.00	121.00	9003360098000
0.3898			9.900	184.00	121.00	9003360099000
0.3937			10.000	184.00	121.00	9003360100000
0.4016			10.200	184.00	121.00	9003360102000
0.4134			10.500	184.00	121.00	9003360105000
0.4252			10.800	195.00	128.00	9003360108000
0.4331			11.000	195.00	128.00	9003360110000
0.4528			11.500	195.00	128.00	9003360115000
0.4646			11.800	195.00	128.00	9003360118000
0.4689	15/32		11.910	205.00	134.00	9003360119100
0.4724			12.000	205.00	134.00	9003360120000

Alternative Drill Series:

- #535 HSS, GT100, 10xD, 130 pt, Bright/Nitrided lands > 2.36
- #668 HSS, GT100, 10xD, 130 pt, TiN
- #390 HSS, GT100, 10xD, 130 pt, Bright, Coolant Fed

*Items listed in red are non-stocked items, and may take 2 - 6 weeks to receive

5xD

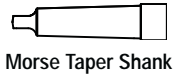

Speeds & Feeds
information pg 434

Series 345

General Purpose

Cobalt, general purpose (Type N), 118° point, Form A
web thinned all dia., Morse Taper shank, RH helix

Cut / Shank Dia. = h8 tolerance range

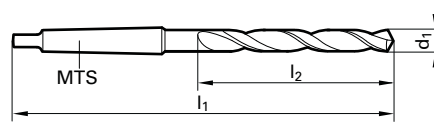

Application Materials:

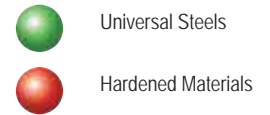

Diameter (d1)			Shank size	l1 mm	l2 mm	EDP #
Dec. inch	Fract. inch	Wire / letter				
0.1181			MTS 1	114.00	33.00	900345003000
0.1575			MTS 1	124.00	43.00	900345004000
0.1969			MTS 1	133.00	52.00	900345005000
0.2042			MTS 1	133.00	52.00	9003450052000
0.2165			MTS 1	135.00	57.00	9003450055000
0.2362			MTS 1	138.00	52.00	9003450060000
0.2441			MTS 1	144.00	63.00	9003450062000
0.2500	1/4		MTS 1	144.00	63.00	9003450063500
0.2559			MTS 1	144.00	63.00	9003450065000
0.2657	17/64	H	MTS 1	150.00	69.00	9003450067500
0.2756			MTS 1	150.00	69.00	9003450070000
0.3126	5/16		MTS 1	156.00	75.00	9003450079400
0.3425			MTS 1	162.00	81.00	9003450087000
0.3701			MTS 1	162.00	81.00	9003450094000
0.3748	3/8		MTS 1	168.00	87.00	9003450095200
0.3906	25/64		MTS 1	168.00	87.00	9003450099200
0.3937			MTS 1	168.00	87.00	9003450100000
0.3976			MTS 1	168.00	87.00	9003450101000
0.4016			MTS 1	168.00	87.00	9003450102000
0.4035			MTS 1	168.00	87.00	9003450102500
0.4055			MTS 1	168.00	87.00	9003450103000
0.4063	13/32		MTS 1	168.00	87.00	9003450103200
0.4134			MTS 1	168.00	87.00	9003450105000
0.4220	27/64		MTS 1	175.00	94.00	9003450107200
0.4232			MTS 1	175.00	94.00	9003450107500
0.4252			MTS 1	175.00	94.00	9003450108000
0.4331			MTS 1	175.00	94.00	9003450110000
0.4374	7/16		MTS 1	175.00	94.00	9003450111100
0.4409			MTS 1	175.00	94.00	9003450112000
0.4429			MTS 1	175.00	94.00	9003450112500
0.4528			MTS 1	175.00	94.00	9003450115000
0.4606			MTS 1	175.00	94.00	9003450117000
0.4626			MTS 1	175.00	94.00	9003450117500
0.4646			MTS 1	175.00	94.00	9003450118000
0.4689	15/32		MTS 1	182.00	101.00	9003450119100
0.4724			MTS 1	182.00	101.00	9003450120000
0.4764			MTS 1	182.00	101.00	9003450121000
0.4803			MTS 1	182.00	101.00	9003450122000
0.4823			MTS 1	182.00	101.00	9003450122500
0.4843	31/64		MTS 1	182.00	101.00	9003450123000
0.4921			MTS 1	182.00	101.00	9003450125000
0.5000	1/2		MTS 1	182.00	101.00	9003450127000
0.5020			MTS 1	182.00	101.00	9003450127500
0.5039			MTS 1	182.00	101.00	9003450128000
0.5118			MTS 1	182.00	101.00	9003450130000
0.5157	33/64		MTS 1	182.00	101.00	9003450131000
0.5197			MTS 1	182.00	101.00	9003450132000
0.5217			MTS 1	189.00	108.00	9003450132500
0.5311	17/32		MTS 1	189.00	108.00	9003450134900
0.5315			MTS 1	189.00	108.00	9003450135000
0.5354			MTS 1	189.00	108.00	9003450136000

Diameter (d1)			Shank size	l1 mm	l2 mm	EDP #
Dec. inch	Fract. inch	Wire / letter				
0.5394			MTS 1	189.00	108.00	9003450137000
0.5413			MTS 1	189.00	108.00	9003450137500
0.5433			MTS 1	189.00	108.00	9003450138000
0.5469	35/64		MTS 1	189.00	108.00	9003450138900
0.5512			MTS 1	189.00	108.00	9003450140000
0.5551			MTS 2	212.00	114.00	9003450141000
0.5591			MTS 2	212.00	114.00	9003450142000
0.5610			MTS 2	212.00	114.00	9003450142500
0.5626	9/16		MTS 2	212.00	114.00	9003450142900
0.5709			MTS 2	212.00	114.00	9003450145000
0.5780	37/64		MTS 2	212.00	114.00	9003450146800
0.5807			MTS 2	212.00	114.00	9003450147500
0.5906			MTS 2	212.00	114.00	9003450150000
0.5937	19/32		MTS 2	218.00	120.00	9003450150800
0.5984			MTS 2	218.00	120.00	9003450152000
0.6004			MTS 2	218.00	120.00	9003450152500
0.6102			MTS 2	218.00	120.00	9003450155000
0.6201			MTS 2	218.00	120.00	9003450157500
0.6248	5/8		MTS 2	218.00	120.00	9003450158700
0.6260			MTS 2	218.00	120.00	9003450159000
0.6299			MTS 2	218.00	120.00	9003450160000
0.6398			MTS 2	223.00	125.00	9003450162500
0.6406	41/64		MTS 2	223.00	125.00	9003450162700
0.6457			MTS 2	223.00	125.00	9003450164000
0.6496			MTS 2	223.00	125.00	9003450165000
0.6563	21/32		MTS 2	223.00	125.00	9003450166700
0.6594			MTS 2	223.00	125.00	9003450167500
0.6693			MTS 2	223.00	125.00	9003450170000
0.6720	43/64		MTS 2	228.00	130.00	9003450170700
0.6791			MTS 2	228.00	130.00	9003450172500
0.6874	11/16		MTS 2	228.00	130.00	9003450174600
0.6890			MTS 2	228.00	130.00	9003450175000
0.6988			MTS 2	228.00	130.00	9003450177500
0.7031	45/64		MTS 2	228.00	130.00	9003450178600
0.7087			MTS 2	228.00	130.00	9003450180000
0.7185			MTS 2	233.00	135.00	9003450182500
0.7189	23/32		MTS 2	233.00	135.00	9003450182600
0.7283			MTS 2	233.00	135.00	9003450185000
0.7343	47/64		MTS 2	233.00	135.00	9003450186500
0.7382			MTS 2	233.00	135.00	9003450187500
0.7480			MTS 2	233.00	135.00	9003450190000
0.7500	3/4		MTS 2	238.00	140.00	9003450190500
0.7579			MTS 2	238.00	140.00	9003450192500
0.7657	49/64		MTS 2	238.00	140.00	9003450194500
0.7677			MTS 2	238.00	140.00	9003450195000
0.7776			MTS 2	238.00	140.00	9003450197500
0.7811	25/32		MTS 2	238.00	140.00	9003450198400
0.7874			MTS 2	238.00	140.00	9003450200000
0.7972			MTS 2	243.00	145.00	9003450202500
0.8071			MTS 2	243.00	145.00	9003450205000
0.8126	13/16		MTS 2	243.00	145.00	9003450206400

Series 345

Speeds & Feeds information pg 434

Twist Drills

Diameter (d1)			Shank size	l1 mm	l2 mm	EDP #
Dec. inch	Fract. inch	Wire / letter				
0.8169			MTS 2	243.00	145.00	9003450207500
0.8268			MTS 2	243.00	145.00	9003450210000
0.8366			MTS 2	248.00	150.00	9003450212500
0.8465			MTS 2	248.00	150.00	9003450215000
0.8563			MTS 2	248.00	150.00	9003450217500
0.8661			MTS 2	248.00	150.00	9003450220000
0.8748	7/8		MTS 2	248.00	150.00	9003450222200
0.8760			MTS 2	248.00	150.00	9003450222500
0.8858			MTS 2	253.00	155.00	9003450225000
0.9055			MTS 2	253.00	155.00	9003450230000
0.9063	29/32		MTS 2	253.00	155.00	9003450230200
0.9252			MTS 3	276.00	155.00	9003450235000
0.9370			MTS 3	281.00	160.00	9003450238000

Diameter (d1)			Shank size	l1 mm	l2 mm	EDP #
Dec. inch	Fract. inch	Wire / letter				
0.9374	15/16		MTS 3	281.00	160.00	9003450238100
0.9449			MTS 3	281.00	160.00	9003450240000
0.9547			MTS 3	281.00	160.00	9003450242500
0.9646			MTS 3	281.00	160.00	9003450245000
0.9843	63/64		MTS 3	281.00	160.00	9003450250000
0.9941			MTS 3	286.00	165.00	9003450252500
1.0000	1		MTS 3	286.00	165.00	9003450254000

Alternative Drill Series:
#245 HSS, GP, 5xD, 118 pt, Oxide
#654 HSS, GP, 5xD, 118 pt, TiN

10xD



Bright Finish



Coolant Through



Straight Shank

Speeds & Feeds information pg 435

Series 390

GT100 Coolant Fed Parabolic

HSS, GT 100 deep hole, taper length, 130° point, Form A web thinned all dia., standard straight shank, RH helix

Cut / Shank Dia. = h8 tolerance range

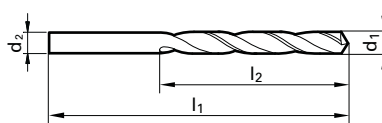

$$d_1 = d_2$$

Application Materials:

- General Steels
- Universal Steels
- Cast Iron
- Aluminum & Alloys

Diameter (d1)			l1 mm	l2 mm	EDP #
Dec. inch	Fract. inch	Wire / letter			
0.1181			100.00	66.00	9003900030000
0.1299			106.00	69.00	9003900033000
0.1378			112.00	73.00	9003900035000
0.1575			119.00	78.00	9003900040000
0.1654			119.00	78.00	9003900042000
0.1772		16	126.00	82.00	9003900045000
0.1969			132.00	87.00	9003900050000
0.2165			139.00	91.00	9003900055000
0.2362			139.00	91.00	9003900060000
0.2559			148.00	97.00	9003900065000
0.2677			156.00	102.00	9003900068000
0.2756			156.00	102.00	9003900070000
0.2953			156.00	102.00	9003900075000
0.3150			165.00	109.00	9003900080000
0.3346			165.00	109.00	9003900085000

Diameter (d1)			l1 mm	l2 mm	EDP #
Dec. inch	Fract. inch	Wire / letter			
0.3543			175.00	115.00	9003900090000
0.3740			175.00	115.00	9003900095000
0.3937			184.00	121.00	9003900100000
0.4016			184.00	121.00	9003900102000
0.4134			184.00	121.00	9003900105000
0.4331			195.00	128.00	9003900110000
0.4528			195.00	128.00	9003900115000
0.4724			205.00	134.00	9003900120000
0.5118			205.00	134.00	9003900130000

Alternative Drill Series:
#1131 Cobalt, GT80IC, 5xD, 130 pt, Bright
#5525, Carbide, RT100U, 12xD, FIREX®

*Items listed in red are non-stocked items, and may take 2 - 6 weeks to receive

10xD



Bright Finish



External Coolant



Straight Shank

Speeds & Feeds
information pg 435

Series 501

GT50 Parabolic

HSS, GT 50 deep hole, taper length, 130° point, Form A web
thinned >2.36mm dia., standard straight shank, RH helix

Cut / Shank Dia. = h8 tolerance range

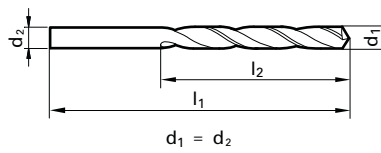

Application Materials:



General Steels



Aluminum & Alloys

Diameter (d1)			l1 mm	l2 mm	EDP #
Dec. inch	Fract. inch	Wire / letter			
0.0394			56.00	33.00	9005010010000
0.0402		60	56.00	33.00	9005010010200
0.0409		59	56.00	33.00	9005010010400
0.0413			56.00	33.00	9005010010500
0.0421		58	60.00	37.00	9005010010700
0.0429		57	1.090	37.00	9005010010900
0.0433			1.100	60.00	9005010011000
0.0453			1.150	60.00	9005010011500
0.0465		56	1.180	60.00	9005010011800
0.0469	3/64		1.190	65.00	9005010011900
0.0472			1.200	65.00	9005010012000
0.0492			1.250	65.00	9005010012500
0.0512			1.300	65.00	9005010013000
0.0520		55	1.320	65.00	9005010013200
0.0551		54	1.400	70.00	9005010014000
0.0591			1.500	70.00	9005010015000
0.0594		53	1.510	76.00	9005010015100
0.0610			1.550	76.00	9005010015500
0.0626	1/16		1.590	76.00	9005010015900
0.0630			1.600	76.00	9005010016000
0.0634		52	1.610	76.00	9005010016100
0.0669		51	1.700	76.00	9005010017000
0.0689			1.750	80.00	9005010017500
0.0701		50	1.780	80.00	9005010017800
0.0709			1.800	80.00	9005010018000
0.0728		49	1.850	80.00	9005010018500
0.0748			1.900	80.00	9005010019000
0.0768			1.950	85.00	9005010019500
0.0780	5/64		1.980	85.00	9005010019800
0.0783		47	1.990	85.00	9005010019900
0.0787			2.000	85.00	9005010020000
0.0807			2.050	85.00	9005010020500
0.0811		46	2.060	85.00	9005010020600
0.0819		45	2.080	85.00	9005010020800
0.0827			2.100	85.00	9005010021000
0.0846			2.150	90.00	9005010021500
0.0858		44	2.180	90.00	9005010021800
0.0866			2.200	90.00	9005010022000
0.0886			2.250	90.00	9005010022500
0.0890		43	2.260	90.00	9005010022600
0.0906			2.300	90.00	9005010023000
0.0925			2.350	90.00	9005010023500
0.0933		42	2.370	95.00	9005010023700
0.0937	3/32		2.380	95.00	9005010023800
0.0945			2.400	95.00	9005010024000
0.0961		41	2.440	95.00	9005010024400
0.0965			2.450	95.00	9005010024500
0.0980		40	2.490	95.00	9005010024900
0.0984			2.500	95.00	9005010025000
0.0992			2.520	95.00	9005010025200
0.0996		39	2.530	95.00	9005010025300
0.1004			2.550	95.00	9005010025500
0.1016		38	2.580	95.00	9005010025800
0.1024			2.600	95.00	9005010026000
0.1039		37	2.640	95.00	9005010026400

Diameter (d1)			l1 mm	l2 mm	EDP #
Dec. inch	Fract. inch	Wire / letter			
0.1063			100.00	66.00	9005010027000
0.1067		36	2.710	100.00	9005010027100
0.1083			2.750	100.00	9005010027500
0.1094	7/64		2.780	100.00	9005010027800
0.1098		35	2.790	100.00	9005010027900
0.1102			2.800	100.00	9005010028000
0.1110		34	2.820	100.00	9005010028200
0.1122			2.850	100.00	9005010028500
0.1130		33	2.870	100.00	9005010028700
0.1142			2.900	100.00	9005010029000
0.1161		32	2.950	100.00	9005010029500
0.1181			3.000	100.00	9005010030000
0.1201		31	3.050	106.00	9005010030500
0.1220			3.100	106.00	9005010031000
0.1248	1/8		3.170	106.00	9005010031700
0.1260			3.200	106.00	9005010032000
0.1280			3.250	106.00	9005010032500
0.1283		30	3.260	106.00	9005010032600
0.1299			3.300	106.00	9005010033000
0.1319			3.350	106.00	9005010033500
0.1339			3.400	112.00	9005010034000
0.1358		29	3.450	112.00	9005010034500
0.1378			3.500	112.00	9005010035000
0.1406	9/64	28	3.570	112.00	9005010035700
0.1417			3.600	112.00	9005010036000
0.1437			3.650	112.00	9005010036500
0.1441		27	3.660	112.00	9005010036600
0.1457			3.700	112.00	9005010037000
0.1496		25	3.800	119.00	9005010038000
0.1520		24	3.860	119.00	9005010038600
0.1535			3.900	119.00	9005010039000
0.1539		23	3.910	119.00	9005010039100
0.1563	5/32		3.970	119.00	9005010039700
0.1571		22	3.990	119.00	9005010039900
0.1575			4.000	119.00	9005010040000
0.1591		21	4.040	119.00	9005010040400
0.1610		20	4.090	119.00	9005010040900
0.1614			4.100	119.00	9005010041000
0.1654			4.200	119.00	9005010042000
0.1661		19	4.220	119.00	9005010042200
0.1673			4.250	119.00	9005010042500
0.1693		18	4.300	126.00	9005010043000
0.1720	11/64		4.370	126.00	9005010043700
0.1728		17	4.390	126.00	9005010043900
0.1732			4.400	126.00	9005010044000
0.1772		16	4.500	126.00	9005010045000
0.1799		15	4.570	126.00	9005010045700
0.1811			4.600	126.00	9005010046000
0.1819		14	4.620	126.00	9005010046200
0.1850		13	4.700	126.00	9005010047000
0.1870			4.750	126.00	9005010047500
0.1874	3/16		4.760	132.00	9005010047600
0.1890		12	4.800	132.00	9005010048000
0.1909		11	4.850	132.00	9005010048500
0.1929			4.900	132.00	9005010049000

Extra Length

#1



Nitrided lands/polished flutes >2.36mm dia.



External Coolant



Straight Shank

Speeds & Feeds information pg 436

Series 502

GT100 Parabolic

HSS, GT 100 deep hole, extra length #1, 130° point, Form A web thinned all dia., standard straight shank, RH helix

Cut / Shank Dia. = h8 tolerance range

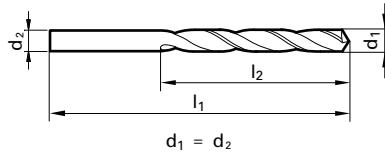

Application Materials:



General Steels



Aluminum & Alloys



Cast Iron

Diameter (d1)				l1 mm	l2 mm	EDP #
Dec. inch	Fract. inch	Wire / letter	mm			
0.0768			1.950	125.00	85.00	9005020019500
0.0787			2.000	125.00	85.00	9005020020000
0.0807			2.050	125.00	85.00	9005020020500
0.0827			2.100	125.00	85.00	9005020021000
0.0866			2.200	135.00	90.00	9005020022000
0.0906			2.300	135.00	90.00	9005020023000
0.0933		42	2.370	150.00	100.00	9005020023700
0.0937	3/32		2.380	150.00	100.00	9005020023800
0.0945			2.400	150.00	100.00	9005020024000
0.0984			2.500	150.00	100.00	9005020025000
0.1004			2.550	150.00	100.00	9005020025500
0.1016		38	2.580	150.00	100.00	9005020025800
0.1024			2.600	150.00	100.00	9005020026000
0.1063			2.700	150.00	100.00	9005020027000
0.1094	7/64		2.780	150.00	100.00	9005020027800
0.1102			2.800	150.00	100.00	9005020028000
0.1122			2.850	150.00	100.00	9005020028500
0.1130		33	2.870	150.00	100.00	9005020028700
0.1142			2.900	150.00	100.00	9005020029000
0.1161		32	2.950	150.00	100.00	9005020029500
0.1181			3.000	150.00	100.00	9005020030000
0.1193			3.030	155.00	105.00	9005020030300
0.1220			3.100	155.00	105.00	9005020031000
0.1248	1/8		3.170	155.00	105.00	9005020031700
0.1260			3.200	155.00	105.00	9005020032000
0.1280			3.250	155.00	105.00	9005020032500
0.1299			3.300	155.00	105.00	9005020033000
0.1339			3.400	165.00	115.00	9005020034000
0.1378			3.500	165.00	115.00	9005020035000
0.1406	9/64	28	3.570	165.00	115.00	9005020035700
0.1417			3.600	165.00	115.00	9005020036000
0.1457			3.700	165.00	115.00	9005020037000
0.1476			3.750	165.00	115.00	9005020037500
0.1496		25	3.800	175.00	120.00	9005020038000
0.1520		24	3.860	175.00	120.00	9005020038600
0.1535			3.900	175.00	120.00	9005020039000
0.1563	5/32		3.970	175.00	120.00	9005020039700
0.1575			4.000	175.00	120.00	9005020040000
0.1614			4.100	175.00	120.00	9005020041000
0.1654			4.200	175.00	120.00	9005020042000
0.1693		18	4.300	185.00	125.00	9005020043000
0.1720	11/64		4.370	185.00	125.00	9005020043700
0.1732			4.400	185.00	125.00	9005020044000
0.1772		16	4.500	185.00	125.00	9005020045000
0.1799		15	4.570	185.00	125.00	9005020045700
0.1811			4.600	185.00	125.00	9005020046000
0.1850		13	4.700	185.00	125.00	9005020047000
0.1874	3/16		4.760	195.00	135.00	9005020047600
0.1890		12	4.800	195.00	135.00	9005020048000
0.1929			4.900	195.00	135.00	9005020049000
0.1969			5.000	195.00	135.00	9005020050000
0.2008			5.100	195.00	135.00	9005020051000
0.2012		7	5.110	195.00	135.00	9005020051100

Diameter (d1)				l1 mm	l2 mm	EDP #
Dec. inch	Fract. inch	Wire / letter	mm			
0.2031	13/64		5.160	195.00	135.00	9005020051600
0.2047			5.200	195.00	135.00	9005020052000
0.2087			5.300	195.00	135.00	9005020053000
0.2126			5.400	205.00	140.00	9005020054000
0.2165			5.500	205.00	140.00	9005020055000
0.2189	7/32		5.560	205.00	140.00	9005020055600
0.2205			5.600	205.00	140.00	9005020056000
0.2244			5.700	205.00	140.00	9005020057000
0.2264			5.750	205.00	140.00	9005020057500
0.2283			5.800	205.00	140.00	9005020058000
0.2323			5.900	205.00	140.00	9005020059000
0.2343	15/64		5.950	205.00	140.00	9005020059500
0.2362			6.000	205.00	140.00	9005020060000
0.2382			6.050	215.00	150.00	9005020060500
0.2402			6.100	215.00	150.00	9005020061000
0.2441			6.200	215.00	150.00	9005020062000
0.2461		D	6.250	215.00	150.00	9005020062500
0.2480			6.300	215.00	150.00	9005020063000
0.2500	1/4	E	6.350	215.00	150.00	9005020063500
0.2520			6.400	215.00	150.00	9005020064000
0.2559			6.500	215.00	150.00	9005020065000
0.2598			6.600	215.00	150.00	9005020066000
0.2638			6.700	215.00	150.00	9005020067000
0.2657	17/64	H	6.750	225.00	155.00	9005020067500
0.2677			6.800	225.00	155.00	9005020068000
0.2717		I	6.900	225.00	155.00	9005020069000
0.2756			7.000	225.00	155.00	9005020070000
0.2795			7.100	225.00	155.00	9005020071000
0.2835			7.200	225.00	155.00	9005020072000
0.2874			7.300	225.00	155.00	9005020073000
0.2913			7.400	225.00	155.00	9005020074000
0.2953			7.500	225.00	155.00	9005020075000
0.2969	19/64		7.540	240.00	165.00	9005020075400
0.2992			7.600	240.00	165.00	9005020076000
0.3031			7.700	240.00	165.00	9005020077000
0.3051			7.750	240.00	165.00	9005020077500
0.3071			7.800	240.00	165.00	9005020078000
0.3110			7.900	240.00	165.00	9005020079000
0.3126	5/16		7.940	240.00	165.00	9005020079400
0.3150			8.000	240.00	165.00	9005020080000
0.3189			8.100	240.00	165.00	9005020081000
0.3228		P	8.200	240.00	165.00	9005020082000
0.3268			8.300	240.00	165.00	9005020083000
0.3280	21/64		8.330	240.00	165.00	9005020083300
0.3307			8.400	240.00	165.00	9005020084000
0.3319		Q	8.430	240.00	165.00	9005020084300
0.3346			8.500	240.00	165.00	9005020085000
0.3386			8.600	250.00	175.00	9005020086000
0.3425			8.700	250.00	175.00	9005020087000
0.3437	11/32		8.730	250.00	175.00	9005020087300
0.3465			8.800	250.00	175.00	9005020088000
0.3543			9.000	250.00	175.00	9005020090000
0.3622			9.200	250.00	175.00	9005020092000

Series 502

Speeds & Feeds information pg 436

Twist Drills

Diameter (d1)			mm	I1 mm	I2 mm	EDP #
Dec. inch	Fract. inch	Wire / letter				
0.3661			9.300	250.00	175.00	9005020093000
0.3701			9.400	250.00	175.00	9005020094000
0.3740			9.500	250.00	175.00	9005020095000
0.3748	3/8		9.520	265.00	185.00	9005020095200
0.3780			9.600	265.00	185.00	9005020096000
0.3819			9.700	265.00	185.00	9005020097000
0.3858		W	9.800	265.00	185.00	9005020098000
0.3898			9.900	265.00	185.00	9005020099000
0.3906	25/64		9.920	265.00	185.00	9005020099200
0.3937			10.000	265.00	185.00	9005020100000
0.4016			10.200	265.00	185.00	9005020102000
0.4063	13/32		10.320	265.00	185.00	9005020103200
0.4134			10.500	265.00	185.00	9005020105000
0.4220	27/64		10.720	280.00	195.00	9005020107200
0.4331			11.000	280.00	195.00	9005020110000
0.4374	7/16		11.110	280.00	195.00	9005020111100

Diameter (d1)			mm	I1 mm	I2 mm	EDP #
Dec. inch	Fract. inch	Wire / letter				
0.4409			11.200	280.00	195.00	9005020112000
0.4528			11.500	280.00	195.00	9005020115000
0.4531	29/64		11.510	280.00	195.00	9005020115100
0.4646			11.800	280.00	195.00	9005020118000
0.4724			12.000	295.00	205.00	9005020120000
0.4921			12.500	295.00	205.00	9005020125000
0.5000	1/2		12.700	295.00	205.00	9005020127000
0.5118			13.000	295.00	205.00	9005020130000

Alternative Drill Series:

- #670 HSS, GT100, >10xD, 130 pt, TiN
- #618 Cobalt, GT100, >10xD, 130 pt, Bright
- #524 HSS, GT50, >10xD, 130 pt, Bright
- #235 HSS, GT100, >10xD, 118 pt, Bright/Steam Oxide > 2.36

*Items listed in red are non-stocked items, and may take 2 - 6 weeks to receive

Extra Length

#2



Nitrided lands/polished flutes >2.36mm dia.



External Coolant



Straight Shank

Speeds & Feeds information pg 436

Series 503

GT100 Parabolic

HSS, GT 100 deep hole, extra length #2, 130° point, Form A web thinned all dia., standard straight shank, RH helix

Cut / Shank Dia. = h8 tolerance range

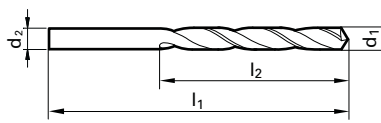

$$d_1 = d_2$$

Application Materials:

- General Steels
- Aluminum & Alloys
- Cast Iron

Diameter (d1)			mm	l1 mm	l2 mm	EDP #
Dec. inch	Fract. inch	Wire / letter				
0.0906			2.300	170.00	115.00	9005030023000
0.1102			2.800	190.00	130.00	9005030028000
0.1181			3.000	190.00	130.00	9005030030000
0.1193			3.030	200.00	135.00	9005030030300
0.1220			3.100	200.00	135.00	9005030031000
0.1248	1/8		3.170	200.00	135.00	9005030031700
0.1260			3.200	200.00	135.00	9005030032000
0.1299			3.300	200.00	135.00	9005030033000
0.1339			3.400	210.00	145.00	9005030034000
0.1378			3.500	210.00	145.00	9005030035000
0.1406	9/64	28	3.570	210.00	145.00	9005030035700
0.1417			3.600	210.00	145.00	9005030036000
0.1457			3.700	210.00	145.00	9005030037000
0.1496		25	3.800	220.00	150.00	9005030038000
0.1535			3.900	220.00	150.00	9005030039000
0.1563	5/32		3.970	220.00	150.00	9005030039700
0.1575			4.000	220.00	150.00	9005030040000
0.1614			4.100	220.00	150.00	9005030041000
0.1654			4.200	220.00	150.00	9005030042000
0.1693		18	4.300	235.00	160.00	9005030043000
0.1720	11/64		4.370	235.00	160.00	9005030043700
0.1732			4.400	235.00	160.00	9005030044000
0.1772		16	4.500	235.00	160.00	9005030045000
0.1850		13	4.700	235.00	160.00	9005030047000
0.1874	3/16		4.760	245.00	170.00	9005030047600
0.1890		12	4.800	245.00	170.00	9005030048000
0.1929			4.900	245.00	170.00	9005030049000
0.1969			5.000	245.00	170.00	9005030050000
0.2008			5.100	245.00	170.00	9005030051000
0.2031	13/64		5.160	245.00	170.00	9005030051600
0.2047			5.200	245.00	170.00	9005030052000
0.2087			5.300	245.00	170.00	9005030053000
0.2126			5.400	260.00	180.00	9005030054000
0.2165			5.500	260.00	180.00	9005030055000
0.2189	7/32		5.560	260.00	180.00	9005030055600
0.2244			5.700	260.00	180.00	9005030057000
0.2283			5.800	260.00	180.00	9005030058000
0.2323			5.900	260.00	180.00	9005030059000
0.2343	15/64		5.950	260.00	180.00	9005030059500
0.2362			6.000	260.00	180.00	9005030060000
0.2402			6.100	275.00	190.00	9005030061000
0.2421		C	6.150	275.00	190.00	9005030061500
0.2441			6.200	275.00	190.00	9005030062000
0.2480			6.300	275.00	190.00	9005030063000
0.2500	1/4	E	6.350	275.00	190.00	9005030063500

Diameter (d1)			mm	l1 mm	l2 mm	EDP #
Dec. inch	Fract. inch	Wire / letter				
0.2520			6.400	275.00	190.00	9005030064000
0.2559			6.500	275.00	190.00	9005030065000
0.2598			6.600	275.00	190.00	9005030066000
0.2638			6.700	275.00	190.00	9005030067000
0.2657	17/64	H	6.750	290.00	200.00	9005030067500
0.2677			6.800	290.00	200.00	9005030068000
0.2717		I	6.900	290.00	200.00	9005030069000
0.2756			7.000	290.00	200.00	9005030070000
0.2811	9/32	K	7.140	290.00	200.00	9005030071400
0.2835			7.200	290.00	200.00	9005030072000
0.2953			7.500	290.00	200.00	9005030075000
0.2969	19/64		7.540	305.00	210.00	9005030075400
0.3071			7.800	305.00	210.00	9005030078000
0.3126	5/16		7.940	305.00	210.00	9005030079400
0.3150			8.000	305.00	210.00	9005030080000
0.3228		P	8.200	305.00	210.00	9005030082000
0.3280	21/64		8.330	305.00	210.00	9005030083300
0.3346			8.500	305.00	210.00	9005030085000
0.3386			8.600	320.00	220.00	9005030086000
0.3437	11/32		8.730	320.00	220.00	9005030087300
0.3543			9.000	320.00	220.00	9005030090000
0.3583			9.100	320.00	220.00	9005030091000
0.3740			9.500	320.00	220.00	9005030095000
0.3748	3/8		9.520	340.00	235.00	9005030095200
0.3819			9.700	340.00	235.00	9005030097000
0.3858		W	9.800	340.00	235.00	9005030098000
0.3906	25/64		9.920	340.00	235.00	9005030099200
0.3937			10.000	340.00	235.00	9005030100000
0.4134			10.500	340.00	235.00	9005030105000
0.4220	27/64		10.720	365.00	250.00	9005030107200
0.4331			11.000	365.00	250.00	9005030110000
0.4374	7/16		11.110	365.00	250.00	9005030111100
0.4528			11.500	365.00	250.00	9005030115000
0.4531	29/64		11.510	365.00	250.00	9005030115100
0.4689	15/32		11.910	375.00	260.00	9005030119100
0.4724			12.000	375.00	260.00	9005030120000
0.4843	31/64		12.300	375.00	260.00	9005030123000
0.4921			12.500	375.00	260.00	9005030125000
0.5000	1/2		12.700	375.00	260.00	9005030127000
0.5118			13.000	375.00	260.00	9005030130000

Alternative Drill Series:

- #671 HSS, GT100, >10xD, 130 pt, TiN
- #619 Cobalt, GT100, >10xD, 130 pt, Bright

Extra Length #3



Nitrated lands/
polished flutes



External Coolant



Straight Shank

Speeds & Feeds
information pg 437

Series 504

GT100 Parabolic

HSS, GT 100 deep hole, extra length #3, 130° point, Form A web thinned all dia., standard straight shank, RH helix

Cut / Shank Dia. = h8 tolerance range

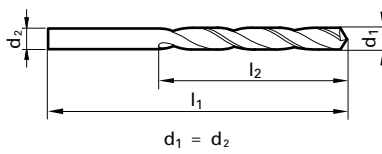

Application Materials:



General Steels



Aluminum & Alloys



Cast Iron

Twist Drills

Diameter (d1)		Wire / letter	mm	l1 mm	l2 mm	EDP #
Dec. inch	Fract. inch					
0.1181			3.000	240.00	160.00	9005040030000
0.1220			3.100	250.00	170.00	9005040031000
0.1248	1/8		3.170	250.00	170.00	9005040031700
0.1260			3.200	250.00	170.00	9005040032000
0.1299			3.300	250.00	170.00	9005040033000
0.1339			3.400	265.00	180.00	9005040034000
0.1378			3.500	265.00	180.00	9005040035000
0.1406	9/64	28	3.570	265.00	180.00	9005040035700
0.1417			3.600	265.00	180.00	9005040036000
0.1457			3.700	265.00	180.00	9005040037000
0.1496		25	3.800	280.00	190.00	9005040038000
0.1535			3.900	280.00	190.00	9005040039000
0.1563	5/32		3.970	280.00	190.00	9005040039700
0.1575			4.000	280.00	190.00	9005040040000
0.1614			4.100	280.00	190.00	9005040041000
0.1654			4.200	280.00	190.00	9005040042000
0.1693		18	4.300	295.00	200.00	9005040043000
0.1720	11/64		4.370	295.00	200.00	9005040043700
0.1732			4.400	295.00	200.00	9005040044000
0.1772		16	4.500	295.00	200.00	9005040045000
0.1811			4.600	295.00	200.00	9005040046000
0.1874	3/16		4.760	315.00	210.00	9005040047600
0.1890		12	4.800	315.00	210.00	9005040048000
0.1929			4.900	315.00	210.00	9005040049000
0.1969			5.000	315.00	210.00	9005040050000
0.2008			5.100	315.00	210.00	9005040051000
0.2047			5.200	315.00	210.00	9005040052000
0.2165			5.500	330.00	225.00	9005040055000
0.2189	7/32		5.560	330.00	225.00	9005040055600
0.2283			5.800	330.00	225.00	9005040058000
0.2343	15/64		5.950	330.00	225.00	9005040059500
0.2362			6.000	330.00	225.00	9005040060000
0.2402			6.100	350.00	235.00	9005040061000
0.2441			6.200	350.00	235.00	9005040062000
0.2480			6.300	350.00	235.00	9005040063000
0.2500	1/4	E	6.350	350.00	235.00	9005040063500
0.2520			6.400	350.00	235.00	9005040064000
0.2559			6.500	350.00	235.00	9005040065000
0.2598			6.600	350.00	235.00	9005040066000
0.2638			6.700	350.00	235.00	9005040067000

Diameter (d1)		Wire / letter	mm	l1 mm	l2 mm	EDP #
Dec. inch	Fract. inch					
0.2657	17/64	H	6.750	370.00	250.00	9005040067500
0.2677			6.800	370.00	250.00	9005040068000
0.2756			7.000	370.00	250.00	9005040070000
0.2811	9/32	K	7.140	370.00	250.00	9005040071400
0.2835			7.200	370.00	250.00	9005040072000
0.2953			7.500	370.00	250.00	9005040075000
0.2969	19/64		7.540	390.00	265.00	9005040075400
0.2992			7.600	390.00	265.00	9005040076000
0.3071			7.800	390.00	265.00	9005040078000
0.3110			7.900	390.00	265.00	9005040079000
0.3126	5/16		7.940	390.00	265.00	9005040079400
0.3150			8.000	390.00	265.00	9005040080000
0.3228		P	8.200	390.00	265.00	9005040082000
0.3280	21/64		8.330	390.00	265.00	9005040083300
0.3346			8.500	390.00	265.00	9005040085000
0.3386			8.600	410.00	280.00	9005040086000
0.3437	11/32		8.730	410.00	280.00	9005040087300
0.3504			8.900	410.00	280.00	9005040089000
0.3543			9.000	410.00	280.00	9005040090000
0.3583			9.100	410.00	280.00	9005040091000
0.3622			9.200	410.00	280.00	9005040092000
0.3740			9.500	410.00	280.00	9005040095000
0.3748	3/8		9.520	430.00	295.00	9005040095200
0.3906	25/64		9.920	430.00	295.00	9005040099200
0.3937			10.000	430.00	295.00	9005040100000
0.4063	13/32		10.320	430.00	295.00	9005040103200
0.4134			10.500	430.00	295.00	9005040105000
0.4220	27/64		10.720	455.00	310.00	9005040107200
0.4331			11.000	455.00	310.00	9005040110000
0.4374	7/16		11.110	455.00	310.00	9005040111100
0.4528			11.500	455.00	310.00	9005040115000
0.4724			12.000	480.00	330.00	9005040120000
0.4921			12.500	480.00	330.00	9005040125000
0.5118			13.000	480.00	330.00	9005040130000

Alternative Drill Series:

#529 HSS, GT50, >10xD, 130 pt, Bright

*Items listed in red are non-stocked items, and may take 2 - 6 weeks to receive

3xD

Series 515

Application Materials:



FIREX® coated

GT 500 DZ High-performance

PM Cobalt, stub length, 130° cone-relief point, Special GN Type B web thinned, standard straight shank, RH helix



Universal Steels



Stainless Steels



Hardened Materials



Cast Iron



External Coolant

Cut / Shank Dia. = h8 tolerance range



Straight Shank

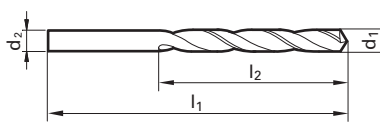

$$d_1 = d_2$$



Speeds & Feeds information pg 437

Dec. inch	Diameter (d1)		l1 mm	l2 mm	EDP #
	Fract. inch	Wire / letter			
0.0394			26.00	6.00	9005150010000
0.0402	60		26.00	6.00	9005150010200
0.0409	59		26.00	6.00	9005150010400
0.0421	58		28.00	7.00	9005150010700
0.0429	57		28.00	7.00	9005150010900
0.0433			28.00	7.00	9005150011000
0.0465	56		28.00	7.00	9005150011800
0.0469	3/64		30.00	8.00	9005150011900
0.0472			30.00	8.00	9005150012000
0.0512			30.00	8.00	9005150013000
0.0520	55		30.00	8.00	9005150013200
0.0551	54		32.00	9.00	9005150014000
0.0591			32.00	9.00	9005150015000
0.0594	53		34.00	10.00	9005150015100
0.0626	1/16		32.00	9.00	9005150015900
0.0630			34.00	10.00	9005150016000
0.0634	52		34.00	10.00	9005150016100
0.0669	51		34.00	10.00	9005150017000
0.0701	50		36.00	11.00	9005150017800
0.0709			36.00	11.00	9005150018000
0.0728	49		36.00	11.00	9005150018500
0.0748			36.00	11.00	9005150019000
0.0760	48		36.00	11.00	9005150019300
0.0780	5/64		36.00	11.00	9005150019800
0.0783			38.00	12.00	9005150019900
0.0787	47		38.00	12.00	9005150020000
0.0811	46		38.00	12.00	9005150020600
0.0819	45		38.00	12.00	9005150020800
0.0827			38.00	12.00	9005150021000
0.0858	44		40.00	13.00	9005150021800
0.0866			40.00	13.00	9005150022000
0.0890	43		40.00	13.00	9005150022600
0.0906			40.00	13.00	9005150023000
0.0933	42		43.00	14.00	9005150023700
0.0937	3/32		43.00	14.00	9005150023800
0.0945			43.00	14.00	9005150024000
0.0961	41		43.00	14.00	9005150024400
0.0980	40		43.00	14.00	9005150024900
0.0984			43.00	14.00	9005150025000
0.0996	39		43.00	14.00	9005150025300
0.1016	38		43.00	14.00	9005150025800
0.1024			43.00	14.00	9005150026000
0.1039	37		43.00	14.00	9005150026400
0.1063			46.00	16.00	9005150027000
0.1067	36		46.00	16.00	9005150027100
0.1094	7/64		46.00	16.00	9005150027800
0.1098	35		46.00	16.00	9005150027900
0.1102			46.00	16.00	9005150028000
0.1110	34		46.00	16.00	9005150028200
0.1130	33		46.00	16.00	9005150028700
0.1142			46.00	16.00	9005150029000
0.1161	32		46.00	16.00	9005150029500
0.1181			46.00	16.00	9005150030000
0.1201	31		49.00	18.00	9005150030500

Dec. inch	Diameter (d1)		l1 mm	l2 mm	EDP #
	Fract. inch	Wire / letter			
0.1220			49.00	18.00	9005150031000
0.1248	1/8		49.00	18.00	9005150031700
0.1260			49.00	18.00	9005150032000
0.1283		30	49.00	18.00	9005150032600
0.1299			49.00	18.00	9005150033000
0.1339			52.00	20.00	9005150034000
0.1358		29	52.00	20.00	9005150034500
0.1378			52.00	20.00	9005150035000
0.1406	9/64	28	52.00	20.00	9005150035700
0.1417			52.00	20.00	9005150036000
0.1441		27	52.00	20.00	9005150036600
0.1457			52.00	20.00	9005150037000
0.1469		26	52.00	20.00	9005150037300
0.1496		25	55.00	22.00	9005150038000
0.1520		24	55.00	22.00	9005150038600
0.1535			55.00	22.00	9005150039000
0.1539		23	55.00	22.00	9005150039100
0.1563	5/32		55.00	22.00	9005150039700
0.1571		22	55.00	22.00	9005150039900
0.1575			55.00	22.00	9005150040000
0.1591		21	55.00	22.00	9005150040400
0.1610		20	55.00	22.00	9005150040900
0.1614			55.00	22.00	9005150041000
0.1654			55.00	22.00	9005150042000
0.1661		19	55.00	22.00	9005150042200
0.1693		18	58.00	24.00	9005150043000
0.1720	11/64		58.00	24.00	9005150043700
0.1728		17	58.00	24.00	9005150043900
0.1732			58.00	24.00	9005150044000
0.1772		16	58.00	24.00	9005150045000
0.1799		15	58.00	24.00	9005150045700
0.1811			58.00	24.00	9005150046000
0.1819		14	58.00	24.00	9005150046200
0.1850		13	58.00	24.00	9005150047000
0.1874	3/16		62.00	26.00	9005150047600
0.1890		12	62.00	26.00	9005150048000
0.1909		11	62.00	26.00	9005150048500
0.1929			62.00	26.00	9005150049000
0.1937		10	62.00	26.00	9005150049200
0.1961		9	62.00	26.00	9005150049800
0.1969			62.00	26.00	9005150050000
0.1992		8	62.00	26.00	9005150050600
0.2008			62.00	26.00	9005150051000
0.2012		7	62.00	26.00	9005150051100
0.2031	13/64		62.00	26.00	9005150051600
0.2039		6	62.00	26.00	9005150051800
0.2047			62.00	26.00	9005150052000
0.2055		5	62.00	26.00	9005150052200
0.2087			62.00	26.00	9005150053000
0.2091		4	66.00	28.00	9005150053100
0.2126			66.00	28.00	9005150054000
0.2130		3	66.00	28.00	9005150054100
0.2165			66.00	28.00	9005150055000
0.2185			66.00	28.00	9005150055500

Series 515

Speeds & Feeds information pg 437

Twist Drills

Dec. inch	Diameter (d1)		l1 mm	l2 mm	EDP #	
	Fract. inch	Wire / letter				
0.2189	7/32		5.560	66.00	28.00	9005150055600
0.2205			5.600	66.00	28.00	9005150056000
0.2209		2	5.610	66.00	28.00	9005150056100
0.2244			5.700	66.00	28.00	9005150057000
0.2280		1	5.790	66.00	28.00	9005150057900
0.2283			5.800	66.00	28.00	9005150058000
0.2323			5.900	66.00	28.00	9005150059000
0.2339		A	5.940	66.00	28.00	9005150059400
0.2343	15/64		5.950	66.00	28.00	9005150059500
0.2362			6.000	66.00	28.00	9005150060000
0.2378		B	6.040	70.00	31.00	9005150060400
0.2402			6.100	70.00	31.00	9005150061000
0.2421		C	6.150	70.00	31.00	9005150061500
0.2441			6.200	70.00	31.00	9005150062000
0.2461		D	6.250	70.00	31.00	9005150062500
0.2480			6.300	70.00	31.00	9005150063000
0.2500	1/4	E	6.350	70.00	31.00	9005150063500
0.2520			6.400	70.00	31.00	9005150064000
0.2559			6.500	70.00	31.00	9005150065000
0.2571		F	6.530	70.00	31.00	9005150065300
0.2598			6.600	70.00	31.00	9005150066000
0.2610		G	6.630	70.00	31.00	9005150066300
0.2638			6.700	70.00	31.00	9005150067000
0.2657	17/64		6.750	70.00	31.00	9005150067500
0.2677			6.800	74.00	34.00	9005150068000
0.2717		I	6.900	74.00	34.00	9005150069000
0.2756			7.000	74.00	34.00	9005150070000
0.2768		J	7.030	74.00	34.00	9005150070300
0.2795			7.100	74.00	34.00	9005150071000
0.2811	9/32	K	7.140	74.00	34.00	9005150071400
0.2835			7.200	74.00	34.00	9005150072000
0.2874			7.300	74.00	34.00	9005150073000
0.2902		L	7.370	74.00	34.00	9005150073700
0.2913			7.400	74.00	34.00	9005150074000
0.2949		M	7.490	74.00	34.00	9005150074900
0.2953			7.500	74.00	34.00	9005150075000
0.2969	19/64		7.540	74.00	34.00	9005150075400
0.2992			7.600	79.00	37.00	9005150076000
0.3020		N	7.670	79.00	37.00	9005150076700
0.3031			7.700	79.00	37.00	9005150077000
0.3071			7.800	79.00	37.00	9005150078000
0.3110			7.900	79.00	37.00	9005150079000
0.3126	5/16		7.940	79.00	37.00	9005150079400
0.3150			8.000	79.00	37.00	9005150080000
0.3161		O	8.030	79.00	37.00	9005150080300
0.3189			8.100	79.00	37.00	9005150081000
0.3228		P	8.200	79.00	37.00	9005150082000
0.3268			8.300	79.00	37.00	9005150083000
0.3280	21/64		8.330	79.00	37.00	9005150083300
0.3307			8.400	79.00	37.00	9005150084000
0.3319		Q	8.430	79.00	37.00	9005150084300
0.3346			8.500	79.00	37.00	9005150085000
0.3386			8.600	84.00	40.00	9005150086000
0.3390		R	8.610	84.00	40.00	9005150086100

Dec. inch	Diameter (d1)		l1 mm	l2 mm	EDP #	
	Fract. inch	Wire / letter				
0.3425			8.700	84.00	40.00	9005150087000
0.3437	11/32		8.730	84.00	40.00	9005150087300
0.3465			8.800	84.00	40.00	9005150088000
0.3480		S	8.840	84.00	40.00	9005150088400
0.3504			8.900	84.00	40.00	9005150089000
0.3543			9.000	84.00	40.00	9005150090000
0.3579		T	9.090	84.00	40.00	9005150090900
0.3583			9.100	84.00	40.00	9005150091000
0.3594	23/64		9.130	84.00	40.00	9005150091300
0.3622			9.200	84.00	40.00	9005150092000
0.3661			9.300	84.00	40.00	9005150093000
0.3677		U	9.340	84.00	40.00	9005150093400
0.3681			9.350	84.00	40.00	9005150093500
0.3701			9.400	84.00	40.00	9005150094000
0.3740			9.500	84.00	40.00	9005150095000
0.3748	3/8		9.520	84.00	40.00	9005150095200
0.3772		V	9.580	89.00	43.00	9005150095800
0.3780			9.600	84.00	40.00	9005150096000
0.3819			9.700	84.00	40.00	9005150097000
0.3858		W	9.800	89.00	43.00	9005150098000
0.3898			9.900	84.00	40.00	9005150099000
0.3906	25/64		9.920	89.00	43.00	9005150099200
0.3937			10.000	89.00	43.00	9005150100000
0.3969		X	10.080	89.00	43.00	9005150100800
0.4016			10.200	89.00	43.00	9005150102000
0.4039		Y	10.260	89.00	43.00	9005150102600
0.4063	13/32		10.320	89.00	43.00	9005150103200
0.4130		Z	10.490	89.00	43.00	9005150104900
0.4134			10.500	89.00	43.00	9005150105000
0.4220	27/64		10.720	89.00	43.00	9005150107200
0.4331			11.000	95.00	47.00	9005150110000
0.4374	7/16		11.110	95.00	47.00	9005150111100
0.4528			11.500	95.00	47.00	9005150115000
0.4531	29/64		11.510	84.00	40.00	9005150115100
0.4646			11.800	84.00	40.00	9005150118000
0.4689	15/32		11.910	95.00	47.00	9005150119100
0.4724			12.000	102.00	51.00	9005150120000
0.4843	31/64		12.300	102.00	51.00	9005150123000
0.4921			12.500	102.00	51.00	9005150125000
0.5000	1/2		12.700	102.00	51.00	9005150127000
0.5118			13.000	102.00	51.00	9005150130000
0.5157	33/64		13.100	102.00	51.00	9005150131000
0.5311	17/32		13.490	107.00	54.00	9005150134900
0.5315			13.500	107.00	54.00	9005150135000
0.5512			14.000	107.00	54.00	9005150140000
0.5626	9/16		14.290	111.00	56.00	9005150142900

Alternative Drill Series:

- #5521 PM Cobalt, GT500, 3xD, 130 pt, TiN
- #659 Cobalt, GV120, 3xD, 130 pt, TiN
- #223 HSS, GP, 3xD, 118 pt, Bright (>2.36mm Steam Oxide)
- #653 HSS, GP, 3xD, 118 pt, TiN

*Items listed in red are non-stocked items, and may take 2 - 6 weeks to receive

Extra Length

#1



Bright Finish



External Coolant



Straight Shank

Speeds & Feeds
information pg 438

Series 524

GT 50 Parabolic

HSS, GT 50 deep hole, extra length #1, 130° point, Form A web thinned
>2.36mm dia., standard straight shank, RH helix

Cut / Shank Dia. = h8 tolerance range

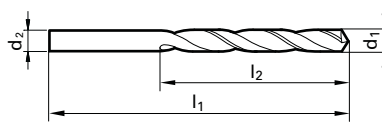

$$d_1 = d_2$$

Application Materials:



General Steels



Aluminum & Alloys

Dec. inch	Fract. inch	Wire / letter	Diameter (d1) mm	l1 mm	l2 mm	EDP #
0.0787			2.000	125.00	85.00	9005240020000
0.0827			2.100	125.00	85.00	9005240021000
0.0866			2.200	135.00	90.00	9005240022000
0.0906			2.300	135.00	90.00	9005240023000
0.0925			2.350	135.00	90.00	9005240023500
0.0937	3/32		2.380	150.00	100.00	9005240023800
0.0945			2.400	150.00	100.00	9005240024000
0.0965			2.450	150.00	100.00	9005240024500
0.0984			2.500	150.00	100.00	9005240025000
0.1024			2.600	150.00	100.00	9005240026000
0.1094	7/64		2.780	150.00	100.00	9005240027800
0.1102			2.800	150.00	100.00	9005240028000
0.1142			2.900	150.00	100.00	9005240029000
0.1161		32	2.950	150.00	100.00	9005240029500
0.1181			3.000	150.00	100.00	9005240030000
0.1220			3.100	155.00	105.00	9005240031000
0.1248	1/8		3.170	155.00	105.00	9005240031700
0.1260			3.200	155.00	105.00	9005240032000
0.1299			3.300	155.00	105.00	9005240033000
0.1319			3.350	155.00	105.00	9005240033500
0.1339			3.400	165.00	115.00	9005240034000
0.1358		29	3.450	165.00	115.00	9005240034500
0.1378			3.500	165.00	115.00	9005240035000
0.1390			3.530	165.00	115.00	9005240035300
0.1406	9/64	28	3.570	165.00	115.00	9005240035700
0.1417			3.600	165.00	115.00	9005240036000
0.1457			3.700	165.00	115.00	9005240037000
0.1496		25	3.800	175.00	120.00	9005240038000
0.1535			3.900	175.00	120.00	9005240039000
0.1563	5/32		3.970	175.00	120.00	9005240039700
0.1575			4.000	175.00	120.00	9005240040000
0.1614			4.100	175.00	120.00	9005240041000
0.1654			4.200	175.00	120.00	9005240042000
0.1673			4.250	175.00	120.00	9005240042500
0.1693		18	4.300	185.00	125.00	9005240043000
0.1720	11/64		4.370	185.00	125.00	9005240043700
0.1732			4.400	185.00	125.00	9005240044000
0.1772		16	4.500	185.00	125.00	9005240045000
0.1811			4.600	185.00	125.00	9005240046000
0.1850		13	4.700	185.00	125.00	9005240047000
0.1874	3/16		4.760	195.00	135.00	9005240047600
0.1890		12	4.800	195.00	135.00	9005240048000
0.1969			5.000	195.00	135.00	9005240050000
0.2008			5.100	195.00	135.00	9005240051000
0.2031	13/64		5.160	195.00	135.00	9005240051600
0.2047			5.200	195.00	135.00	9005240052000
0.2087			5.300	195.00	135.00	9005240053000
0.2126			5.400	205.00	140.00	9005240054000
0.2165			5.500	205.00	140.00	9005240055000

Dec. inch	Fract. inch	Wire / letter	Diameter (d1) mm	l1 mm	l2 mm	EDP #
0.2189	7/32		5.560	205.00	140.00	9005240055600
0.2283			5.800	205.00	140.00	9005240058000
0.2343	15/64		5.950	205.00	140.00	9005240059500
0.2362			6.000	205.00	140.00	9005240060000
0.2402			6.100	215.00	150.00	9005240061000
0.2500	1/4	E	6.350	215.00	150.00	9005240063500
0.2520			6.400	215.00	150.00	9005240064000
0.2559			6.500	215.00	150.00	9005240065000
0.2598			6.600	215.00	150.00	9005240066000
0.2638			6.700	215.00	150.00	9005240067000
0.2657	17/64	H	6.750	225.00	155.00	9005240067500
0.2677			6.800	225.00	155.00	9005240068000
0.2756			7.000	225.00	155.00	9005240070000
0.2874			7.300	225.00	155.00	9005240073000
0.2953			7.500	225.00	155.00	9005240075000
0.2969	19/64		7.540	240.00	165.00	9005240075400
0.2992			7.600	240.00	165.00	9005240076000
0.3071			7.800	240.00	165.00	9005240078000
0.3110			7.900	240.00	165.00	9005240079000
0.3126	5/16		7.940	240.00	165.00	9005240079400
0.3150			8.000	240.00	165.00	9005240080000
0.3189			8.100	240.00	165.00	9005240081000
0.3228		P	8.200	240.00	165.00	9005240082000
0.3280	21/64		8.330	240.00	165.00	9005240083300
0.3346			8.500	240.00	165.00	9005240085000
0.3386			8.600	250.00	175.00	9005240086000
0.3437	11/32		8.730	250.00	175.00	9005240087300
0.3504			8.900	250.00	175.00	9005240089000
0.3543			9.000	250.00	175.00	9005240090000
0.3594	23/64		9.130	250.00	175.00	9005240091300
0.3622			9.200	250.00	175.00	9005240092000
0.3740			9.500	250.00	175.00	9005240095000
0.3748	3/8		9.520	265.00	185.00	9005240095200
0.3937			10.000	265.00	185.00	9005240100000
0.4063	13/32		10.320	265.00	185.00	9005240103200
0.4134			10.500	265.00	185.00	9005240105000
0.4331			11.000	280.00	195.00	9005240110000
0.4374	7/16		11.110	280.00	195.00	9005240111100
0.4528			11.500	280.00	195.00	9005240115000
0.4689	15/32		11.910	295.00	205.00	9005240119100
0.4724			12.000	295.00	205.00	9005240120000
0.5000	1/2		12.700	295.00	205.00	9005240127000

Alternative Drill Series:

- #502 HSS, GT100, >10xD, 130 pt, Bright
- #670 HSS, GT100, >10xD, 130 pt, TiN
- #618 Cobalt, GT100, >10xD, 130 pt, Bright

Extra Length #1



Nitrided lands /
steam oxide >16 mm



External Coolant

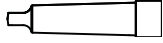

Morse Taper Shank

Speeds & Feeds
information pg 438

Series 526

GT 100 Parabolic

HSS, GT 100 deep hole, extra length #1, 130° point, Form A
web thinned all dia., Morse Taper shank, RH helix

Cut / Shank Dia. = h8 tolerance range

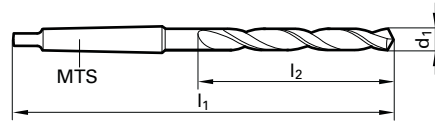

Application Materials:

- General Steels/Brass
- Aluminum & Alloys
- Cast Iron

Twist Drills

Dec. inch	Diameter (d1)		Shank Size	l1 mm	l2 mm	EDP #
	Fract. inch	Wire / letter				
0.3150			MTS 1	265.00	165.00	9005260080000
0.3346			MTS 1	265.00	165.00	9005260085000
0.3465			MTS 1	275.00	175.00	9005260088000
0.3748	3/8		MTS 1	285.00	185.00	9005260095200
0.3906	25/64		MTS 1	285.00	185.00	9005260099200
0.3937			MTS 1	285.00	185.00	9005260100000
0.4063	13/32		MTS 1	285.00	185.00	9005260103200
0.4134			MTS 1	285.00	185.00	9005260105000
0.4220	27/64		MTS 1	300.00	195.00	9005260107200
0.4252			MTS 1	300.00	195.00	9005260108000
0.4331			MTS 1	300.00	195.00	9005260110000
0.4374	7/16		MTS 1	300.00	195.00	9005260111100
0.4528			MTS 1	300.00	195.00	9005260115000
0.4531	29/64		MTS 1	300.00	195.00	9005260115100
0.4724			MTS 1	310.00	205.00	9005260120000
0.4843	31/64		MTS 1	310.00	205.00	9005260123000
0.4921			MTS 1	310.00	205.00	9005260125000
0.5000	1/2		MTS 1	310.00	205.00	9005260127000
0.5079			MTS 1	310.00	205.00	9005260129000
0.5118			MTS 1	310.00	205.00	9005260130000
0.5311	17/32		MTS 1	325.00	220.00	9005260134900
0.5315			MTS 1	325.00	220.00	9005260135000
0.5512			MTS 1	325.00	220.00	9005260140000
0.5591			MTS 2	340.00	220.00	9005260142000
0.5626	9/16		MTS 2	340.00	220.00	9005260142900
0.5709			MTS 2	340.00	220.00	9005260145000

Dec. inch	Diameter (d1)		Shank Size	l1 mm	l2 mm	EDP #
	Fract. inch	Wire / letter				
0.5780	37/64		MTS 2	340.00	220.00	9005260146800
0.5906			MTS 2	340.00	220.00	9005260150000
0.6102			MTS 2	355.00	230.00	9005260155000
0.6248	5/8		MTS 2	355.00	230.00	9005260158700
0.6299			MTS 2	355.00	230.00	9005260160000
0.6496			MTS 2	355.00	230.00	9005260165000
0.6563	21/32		MTS 2	355.00	230.00	9005260166700
0.6693			MTS 2	355.00	230.00	9005260170000
0.6720	43/64		MTS 2	370.00	245.00	9005260170700
0.6874	11/16		MTS 2	370.00	245.00	9005260174600
0.6890			MTS 2	370.00	245.00	9005260175000
0.7087			MTS 2	370.00	245.00	9005260180000
0.7283			MTS 2	370.00	245.00	9005260185000
0.7480			MTS 2	370.00	245.00	9005260190000
0.7657	49/64		MTS 2	385.00	260.00	9005260194500
0.7677			MTS 2	385.00	260.00	9005260195000
1.0827			MTS 3	460.00	305.00	9005260275000
1.1220			MTS 3	460.00	305.00	9005260285000
1.1811			MTS 3	460.00	305.00	9005260300000
1.1874	1 3/16		MTS 3	480.00	320.00	9005260301600

Alternative Drill Series:
#620 Cobalt, GT100, >10xD, 130 pt, Nitrided lands/ Steam Oxide > 16.00

*Items listed in red are non-stocked items, and may take 2 - 6 weeks to receive

Extra Length #2



Nitrided lands /
steam oxide >16 mm



External Coolant

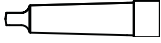

Morse Taper Shank

Speeds & Feeds
information pg 439

Series 527

GT 100 Parabolic

HSS, GT 100 deep hole, extra length #2, 130° point, Form A
web thinned all dia., Morse Taper shank, RH helix

Cut / Shank Dia. = h8 tolerance range

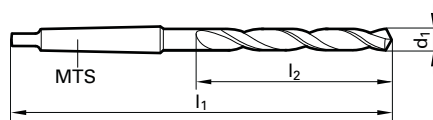

Application Materials:

- General Steels/Brass
- Aluminum & Alloys
- Cast Iron

Dec. inch	Diameter (d1)		Shank Size	l1 mm	l2 mm	EDP #
	Fract. inch	Wire / letter				
0.3150		8.000	MTS 1	330.00	210.00	9005270080000
0.3307		8.400	MTS 1	330.00	210.00	9005270084000
0.3346		8.500	MTS 1	330.00	210.00	9005270085000
0.3504		8.900	MTS 1	345.00	220.00	9005270089000
0.3937		10.000	MTS 1	360.00	235.00	9005270100000
0.4063	13/32	10.320	MTS 1	360.00	235.00	9005270103200
0.4134		10.500	MTS 1	360.00	235.00	9005270105000
0.4331		11.000	MTS 1	375.00	250.00	9005270110000
0.4374	7/16	11.110	MTS 1	375.00	250.00	9005270111100
0.4528		11.500	MTS 1	375.00	250.00	9005270115000
0.4531	29/64	11.510	MTS 1	375.00	250.00	9005270115100
0.4689	15/32	11.910	MTS 1	395.00	260.00	9005270119100
0.4724		12.000	MTS 1	395.00	260.00	9005270120000
0.4843	31/64	12.300	MTS 1	395.00	260.00	9005270123000
0.4921		12.500	MTS 1	395.00	260.00	9005270125000
0.5000	1/2	12.700	MTS 1	395.00	260.00	9005270127000
0.5118		13.000	MTS 1	395.00	260.00	9005270130000
0.5315		13.500	MTS 1	375.00	250.00	9005270135000
0.5469	35/64	13.890	MTS 1	375.00	250.00	9005270138900
0.5512		14.000	MTS 1	410.00	275.00	9005270140000
0.5591		14.200	MTS 2	425.00	275.00	9005270142000
0.5626	9/16	14.290	MTS 2	425.00	275.00	9005270142900
0.5709		14.500	MTS 2	425.00	275.00	9005270145000
0.5906		15.000	MTS 2	425.00	275.00	9005270150000
0.6102		15.500	MTS 2	445.00	295.00	9005270155000
0.6299		16.000	MTS 2	445.00	295.00	9005270160000

Dec. inch	Diameter (d1)		Shank Size	l1 mm	l2 mm	EDP #
	Fract. inch	Wire / letter				
0.6496		16.500	MTS 2	445.00	295.00	9005270165000
0.6693		17.000	MTS 2	445.00	295.00	9005270170000
0.6720	43/64	17.070	MTS 2	465.00	310.00	9005270170700
0.6890		17.500	MTS 2	465.00	310.00	9005270175000
0.7008		17.800	MTS 2	465.00	310.00	9005270178000
0.7087		18.000	MTS 2	465.00	310.00	9005270180000
0.7283		18.500	MTS 2	465.00	310.00	9005270185000
0.7480		19.000	MTS 2	465.00	310.00	9005270190000
0.7657	49/64	19.450	MTS 2	490.00	325.00	9005270194500
0.7677		19.500	MTS 2	490.00	325.00	9005270195000
0.8280	53/64	21.030	MTS 2	490.00	325.00	9005270210300
0.8594	55/64	21.830	MTS 2	515.00	345.00	9005270218300
0.9531	61/64	24.210	MTS 3	555.00	365.00	9005270242100
0.9646		24.500	MTS 3	555.00	365.00	9005270245000
1.0827		27.500	MTS 3	580.00	385.00	9005270275000
1.0937	1 3/32	27.780	MTS 3	580.00	385.00	9005270277800
1.1220		28.500	MTS 3	580.00	385.00	9005270285000
1.1319		28.750	MTS 3	580.00	385.00	9005270287500
1.1614		29.500	MTS 3	580.00	385.00	9005270295000

Alternative Drill Series:

#621 Cobalt, GT100, >10xD, 130 pt, Nitrided lands/Steam Oxide > 16.00

Series 530

Speeds & Feeds information pg 439

Twist Drills

Diameter (d1)						
Dec. inch	Fract. inch	Wire / letter	mm	l1 mm	l2 mm	EDP #
0.2205			5.600	93.00	57.00	9005300056000
0.2209		2	5.610	93.00	57.00	9005300056100
0.2244			5.700	93.00	57.00	9005300057000
0.2280		1	5.790	93.00	57.00	9005300057900
0.2283			5.800	93.00	57.00	9005300058000
0.2323			5.900	93.00	57.00	9005300059000
0.2339		A	5.940	93.00	57.00	9005300059400
0.2343	15/64		5.950	93.00	57.00	9005300059500
0.2362			6.000	93.00	57.00	9005300060000
0.2378		B	6.040	101.00	63.00	9005300060400
0.2402			6.100	101.00	63.00	9005300061000
0.2421		C	6.150	101.00	63.00	9005300061500
0.2441			6.200	101.00	63.00	9005300062000
0.2461		D	6.250	101.00	63.00	9005300062500
0.2480			6.300	101.00	63.00	9005300063000
0.2500	1/4	E	6.350	101.00	63.00	9005300063500
0.2520			6.400	101.00	63.00	9005300064000
0.2559			6.500	101.00	63.00	9005300065000
0.2571		F	6.530	101.00	63.00	9005300065300
0.2598			6.600	101.00	63.00	9005300066000
0.2610		G	6.630	101.00	63.00	9005300066300
0.2638			6.700	101.00	63.00	9005300067000
0.2657	17/64		6.750	101.00	63.00	9005300067500
0.2677			6.800	109.00	69.00	9005300068000
0.2717		I	6.900	109.00	69.00	9005300069000
0.2756			7.000	109.00	69.00	9005300070000
0.2768		J	7.030	109.00	69.00	9005300070300
0.2795			7.100	109.00	69.00	9005300071000
0.2811	9/32	K	7.140	109.00	69.00	9005300071400
0.2835			7.200	109.00	69.00	9005300072000
0.2874			7.300	109.00	69.00	9005300073000
0.2902		L	7.370	109.00	69.00	9005300073700
0.2913			7.400	109.00	69.00	9005300074000
0.2949		M	7.490	109.00	69.00	9005300074900
0.2953			7.500	109.00	69.00	9005300075000
0.2969	19/64		7.540	109.00	69.00	9005300075400
0.2992			7.600	117.00	75.00	9005300076000
0.3020		N	7.670	117.00	75.00	9005300076700
0.3031			7.700	117.00	75.00	9005300077000
0.3071			7.800	117.00	75.00	9005300078000
0.3110			7.900	117.00	75.00	9005300079000
0.3126	5/16		7.940	117.00	75.00	9005300079400
0.3150			8.000	117.00	75.00	9005300080000
0.3161		O	8.030	117.00	75.00	9005300080300
0.3189			8.100	117.00	75.00	9005300081000
0.3228		P	8.200	117.00	75.00	9005300082000
0.3268			8.300	117.00	75.00	9005300083000
0.3280	21/64		8.330	117.00	75.00	9005300083300
0.3307			8.400	117.00	75.00	9005300084000
0.3319		Q	8.430	117.00	75.00	9005300084300
0.3346			8.500	117.00	75.00	9005300085000
0.3390		R	8.610	125.00	81.00	9005300086100

Diameter (d1)						
Dec. inch	Fract. inch	Wire / letter	mm	l1 mm	l2 mm	EDP #
0.3437	11/32		8.730	125.00	81.00	9005300087300
0.3465			8.800	125.00	81.00	9005300088000
0.3480		S	8.840	125.00	81.00	9005300088400
0.3504			8.900	125.00	81.00	9005300089000
0.3543			9.000	125.00	81.00	9005300090000
0.3579		T	9.090	125.00	81.00	9005300090900
0.3583			9.100	125.00	81.00	9005300091000
0.3594	23/64		9.130	125.00	81.00	9005300091300
0.3622			9.200	125.00	81.00	9005300092000
0.3661			9.300	125.00	81.00	9005300093000
0.3677		U	9.340	125.00	81.00	9005300093400
0.3701			9.400	125.00	81.00	9005300094000
0.3740			9.500	125.00	81.00	9005300095000
0.3748	3/8		9.520	125.00	81.00	9005300095200
0.3772		V	9.580	133.00	87.00	9005300095800
0.3780			9.600	133.00	87.00	9005300096000
0.3819			9.700	133.00	87.00	9005300097000
0.3858		W	9.800	133.00	87.00	9005300098000
0.3898			9.900	133.00	87.00	9005300099000
0.3906	25/64		9.920	133.00	87.00	9005300099200
0.3937			10.000	133.00	87.00	9005300100000
0.3969		X	10.080	133.00	87.00	9005300100800
0.4016			10.200	133.00	87.00	9005300102000
0.4039		Y	10.260	133.00	87.00	9005300102600
0.4063	13/32		10.320	133.00	87.00	9005300103200
0.4130		Z	10.490	133.00	87.00	9005300104900
0.4134			10.500	133.00	87.00	9005300105000
0.4220	27/64		10.720	133.00	87.00	9005300107200
0.4331			11.000	142.00	94.00	9005300110000
0.4374	7/16		11.110	142.00	94.00	9005300111100
0.4528			11.500	142.00	94.00	9005300115000
0.4531	29/64		11.510	142.00	94.00	9005300115100
0.4689	15/32		11.910	151.00	101.00	9005300119100
0.4724			12.000	151.00	101.00	9005300120000
0.4843	31/64		12.300	151.00	101.00	9005300123000
0.4921			12.500	151.00	101.00	9005300125000
0.5000	1/2		12.700	151.00	101.00	9005300127000
0.5118			13.000	151.00	101.00	9005300130000
0.5157	33/64		13.100	151.00	101.00	9005300131000
0.5311	17/32		13.490	160.00	108.00	9005300134900
0.5315			13.500	160.00	108.00	9005300135000
0.5512			14.000	160.00	108.00	9005300140000
0.5626	9/16		14.290	169.00	114.00	9005300142900

Alternative Drill Series:

- #5522 PM Cobalt, GT500, 5xD, 130 pt, TiN
- #658 Cobalt, GT100, 5xD, 130 pt, TiN
- #657 Cobalt, Ti, 5xD, 130 pt, TiN
- #622 Cobalt, GT100, 5xD, 130 pt, Bright/Nitrided lands > 2.36

Carbide

NC Spot Drill

NC spot - short, standard straight shank, RH helix



External Coolant



Straight Shank

Cut / Shank Dia. = h6 tolerance range

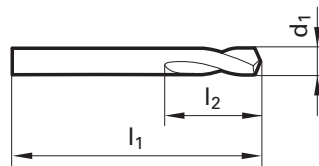

Standard length		Series	557	568	723	556	567	724	546	
		Substrate	HSS	HSS	carbide	HSS	HSS	carbide	carbide	
		Point angle	90°	90°	90°	120°	120°	120°	142°	
		Surface Finish	○	Ⓢ	○	○	Ⓢ	○	○	
dec.	fract.	d1	l1	l2	EDP #	EDP #	EDP #	EDP #	EDP #	
0.1181		3.00	46.0	12.0	9005570030000	9005680030000		9005560030000	9005670030000	
0.1575		4.00	55.0	12.0	9005570040000	9005680040000	9007230040000	9005560040000	9005670040000	9005460040000
0.1969		5.00	62.0	14.0	9005570050000	9005680050000	9007230050000	9005560050000	9005670050000	9005460050000
0.2362		6.00	66.0	16.0	9005570060000	9005680060000	9007230060000	9005560060000	9005670060000	9005460060000
0.2500	1/4	6.35	70.0	17.0	9005570063500	9005680063500	9007230063500	9005560063500	9005670063500	
0.2559		6.50	70.0	17.0				9005560065000		
0.3150		8.00	79.0	21.0	9005570080000	9005680080000	9007230080000	9005560080000	9005670080000	9005460080000
0.3748	3/8	9.52	89.0	25.0	9005570095200	9005680095200	9007230095200	9005560095200	9005670095200	9005460095200
0.3937		10.00	89.0	25.0	9005570100000	9005680100000	9007230100000	9005560100000	9005670100000	9005460100000
0.4724		12.00	102.0	30.0	9005570120000	9005680120000	9007230120000	9005560120000	9005670120000	9005460120000
0.5000	1/2	12.70	102.0	30.0	9005570127000	9005680127000	9007230127000	9005560127000	9005670127000	9005460127000
0.6248	5/8	15.87	115.0	37.5	9005570158700	9005680158700	9007230158700	9005560158700	9005670158700	9005460158700
0.6299		16.00	115.0	37.5	9005570160000	9005680160000	9007230160000	9005560160000	9005670160000	9005460160000
0.7500	3/4	19.05	131.0	45.0	9005570190500	9005680190500	9007230190500	9005560190500	9005670190500	9005460190500
0.7874		20.00	131.0	45.0	9005570200000	9005680200000	9007230200000	9005560200000	9005670200000	9005460200000
0.9843		25.00	151.0	53.0	9005570250000	9005680250000		9005560250000	9005670250000	
1.0000	1	25.40	156.0	53.0	9005570254000	9005680254000		9005560254000	9005670254000	

* Series 546 has a Weldon flat ≥ 8.0 mm diameter

Long length		Series	559				
		Substrate	HSS				
		Point angle	90°				
		Surface Finish	○				
Order Code	dec.	fract.	mm	l1	l2	EDP #	
	6.35	0.2500	1/4	6.35	105.0	17.0	9005590063500
	8.00	0.3150	3/8	8.00	118.0	21.0	9005590080000
	9.52	0.3748	3/8	9.52	132.0	25.0	9005590095200
	12.70	0.5000	1/2	12.70	159.0	30.0	9005590127000
	15.87	0.6248	5/8	15.87	186.0	37.5	9005590158700
	19.05	0.7500	3/4	19.05	213.0	45.0	9005590190500
	25.40	1.0000	1	25.40	216.0	53.0	9005590254000

○ bright

Ⓢ TiN

*Items listed in red are non-stocked items, and may take 2 - 6 weeks to receive

5xD



Nitrided lands/polished flutes >2.36mm dia.



External Coolant



Straight Shank

Speeds & Feeds information pg 440

Series 549

GT100 Parabolic

HSS, GT 100, jobber length, 130° point, Form A web thinned >1.0mm dia., standard straight shank, RH helix

Cut / Shank Dia. = h8 tolerance range

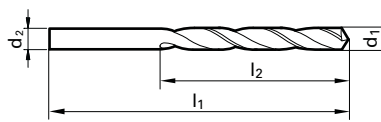
 $d_1 = d_2$

Application Materials:



General Steels/Brass



Aluminum & Alloys



Cast Iron



Universal Steels

Dec. inch	Diameter (d1)		l1 mm	l2 mm	EDP #	
	Fract. inch	Wire / letter				mm
0.0236			0.600	24.00	7.00	9005490006000
0.0276			0.700	28.00	9.00	9005490007000
0.0280		70	0.710	28.00	9.00	9005490007100
0.0311	1/32	68	0.790	30.00	10.00	9005490007900
0.0315			0.800	30.00	10.00	9005490008000
0.0350		65	0.890	32.00	11.00	9005490008900
0.0374			0.950	32.00	11.00	9005490009500
0.0382		62	0.970	34.00	12.00	9005490009700
0.0390		61	0.990	34.00	12.00	9005490009900
0.0394			1.000	34.00	12.00	9005490010000
0.0402		60	1.020	34.00	12.00	9005490010200
0.0409		59	1.040	34.00	12.00	9005490010400
0.0413			1.050	34.00	12.00	9005490010500
0.0421		58	1.070	36.00	14.00	9005490010700
0.0429		57	1.090	36.00	14.00	9005490010900
0.0433			1.100	36.00	14.00	9005490011000
0.0453			1.150	36.00	14.00	9005490011500
0.0465		56	1.180	36.00	14.00	9005490011800
0.0469	3/64		1.190	38.00	16.00	9005490011900
0.0472			1.200	38.00	16.00	9005490012000
0.0480			1.220	38.00	16.00	9005490012200
0.0488			1.240	38.00	16.00	9005490012400
0.0492			1.250	38.00	16.00	9005490012500
0.0512			1.300	38.00	16.00	9005490013000
0.0520		55	1.320	38.00	16.00	9005490013200
0.0531			1.350	40.00	18.00	9005490013500
0.0551		54	1.400	40.00	18.00	9005490014000
0.0571			1.450	40.00	18.00	9005490014500
0.0575			1.460	40.00	18.00	9005490014600
0.0591			1.500	40.00	18.00	9005490015000
0.0594		53	1.510	43.00	20.00	9005490015100
0.0610			1.550	43.00	20.00	9005490015500
0.0614			1.560	43.00	20.00	9005490015600
0.0618			1.570	43.00	20.00	9005490015700
0.0622			1.580	43.00	20.00	9005490015800
0.0626	1/16		1.590	43.00	20.00	9005490015900
0.0630			1.600	43.00	20.00	9005490016000
0.0634		52	1.610	43.00	20.00	9005490016100
0.0638			1.620	43.00	20.00	9005490016200
0.0650			1.650	43.00	20.00	9005490016500
0.0654			1.660	43.00	20.00	9005490016600
0.0657			1.670	43.00	20.00	9005490016700
0.0661			1.680	43.00	20.00	9005490016800
0.0665			1.690	43.00	20.00	9005490016900
0.0669		51	1.700	43.00	20.00	9005490017000
0.0689			1.750	46.00	22.00	9005490017500
0.0701		50	1.780	46.00	22.00	9005490017800
0.0709			1.800	46.00	22.00	9005490018000
0.0728		49	1.850	46.00	22.00	9005490018500
0.0732			1.860	46.00	22.00	9005490018600
0.0748			1.900	46.00	22.00	9005490019000
0.0760		48	1.930	49.00	24.00	9005490019300
0.0768			1.950	49.00	24.00	9005490019500
0.0780	5/64		1.980	49.00	24.00	9005490019800

Dec. inch	Diameter (d1)		l1 mm	l2 mm	EDP #	
	Fract. inch	Wire / letter				mm
0.0783		47	1.990	49.00	24.00	9005490019900
0.0787			2.000	49.00	24.00	9005490020000
0.0795			2.020	49.00	24.00	9005490020200
0.0807			2.050	49.00	24.00	9005490020500
0.0811		46	2.060	49.00	24.00	9005490020600
0.0819		45	2.080	49.00	24.00	9005490020800
0.0827			2.100	49.00	24.00	9005490021000
0.0846			2.150	53.00	27.00	9005490021500
0.0858		44	2.180	53.00	27.00	9005490021800
0.0866			2.200	53.00	27.00	9005490022000
0.0886			2.250	53.00	27.00	9005490022500
0.0890		43	2.260	53.00	27.00	9005490022600
0.0906			2.300	53.00	27.00	9005490023000
0.0917			2.330	53.00	27.00	9005490023300
0.0925			2.350	53.00	27.00	9005490023500
0.0933		42	2.370	57.00	30.00	9005490023700
0.0937	3/32		2.380	57.00	30.00	9005490023800
0.0945			2.400	57.00	30.00	9005490024000
0.0953			2.420	57.00	30.00	9005490024200
0.0961		41	2.440	57.00	30.00	9005490024400
0.0965			2.450	57.00	30.00	9005490024500
0.0976			2.480	57.00	30.00	9005490024800
0.0980		40	2.490	57.00	30.00	9005490024900
0.0984			2.500	57.00	30.00	9005490025000
0.0996		39	2.530	57.00	30.00	9005490025300
0.1004			2.550	57.00	30.00	9005490025500
0.1016		38	2.580	57.00	30.00	9005490025800
0.1024			2.600	57.00	30.00	9005490026000
0.1039		37	2.640	57.00	30.00	9005490026400
0.1043			2.650	57.00	30.00	9005490026500
0.1063			2.700	61.00	33.00	9005490027000
0.1067		36	2.710	61.00	33.00	9005490027100
0.1083			2.750	61.00	33.00	9005490027500
0.1094	7/64		2.780	61.00	33.00	9005490027800
0.1098		35	2.790	61.00	33.00	9005490027900
0.1102			2.800	61.00	33.00	9005490028000
0.1110		34	2.820	61.00	33.00	9005490028200
0.1122			2.850	61.00	33.00	9005490028500
0.1130		33	2.870	61.00	33.00	9005490028700
0.1142			2.900	61.00	33.00	9005490029000
0.1161		32	2.950	61.00	33.00	9005490029500
0.1173			2.980	61.00	33.00	9005490029800
0.1181			3.000	61.00	33.00	9005490030000
0.1201		31	3.050	65.00	36.00	9005490030500
0.1213			3.080	65.00	36.00	9005490030800
0.1220			3.100	65.00	36.00	9005490031000
0.1240			3.150	65.00	36.00	9005490031500
0.1248	1/8		3.170	65.00	36.00	9005490031700
0.1260			3.200	65.00	36.00	9005490032000
0.1268			3.220	65.00	36.00	9005490032200
0.1272			3.230	65.00	36.00	9005490032300
0.1280			3.250	65.00	36.00	9005490032500
0.1283		30	3.260	65.00	36.00	9005490032600
0.1299			3.300	65.00	36.00	9005490033000

Series 549

Speeds & Feeds information pg 440

Twist Drills

Dec. inch	Diameter (d1)		I1 mm	I2 mm	EDP #	
	Fract. inch	Wire / letter				
0.3661			9.300	125.00	81.00	9005490093000
0.3677		U	9.340	125.00	81.00	9005490093400
0.3681			9.350	125.00	81.00	9005490093500
0.3701			9.400	125.00	81.00	9005490094000
0.3740			9.500	125.00	81.00	9005490095000
0.3748	3/8		9.520	133.00	87.00	9005490095200
0.3772		V	9.580	133.00	87.00	9005490095800
0.3780			9.600	133.00	87.00	9005490096000
0.3819			9.700	133.00	87.00	9005490097000
0.3839			9.750	133.00	87.00	9005490097500
0.3858		W	9.800	133.00	87.00	9005490098000
0.3898			9.900	133.00	87.00	9005490099000
0.3906	25/64		9.920	133.00	87.00	9005490099200
0.3937			10.000	133.00	87.00	9005490100000
0.3969		X	10.080	133.00	87.00	9005490100800
0.3976			10.100	133.00	87.00	9005490101000
0.4016			10.200	133.00	87.00	9005490102000
0.4039		Y	10.260	133.00	87.00	9005490102600
0.4055			10.300	133.00	87.00	9005490103000
0.4063	13/32		10.320	133.00	87.00	9005490103200
0.4094			10.400	133.00	87.00	9005490104000
0.4130		Z	10.490	133.00	87.00	9005490104900
0.4134			10.500	133.00	87.00	9005490105000
0.4173			10.600	133.00	87.00	9005490106000
0.4213			10.700	142.00	94.00	9005490107000
0.4220	27/64		10.720	142.00	94.00	9005490107200
0.4232			10.750	142.00	94.00	9005490107500
0.4252			10.800	142.00	94.00	9005490108000
0.4291			10.900	142.00	94.00	9005490109000
0.4331			11.000	142.00	94.00	9005490110000
0.4370			11.100	142.00	94.00	9005490111000
0.4374	7/16		11.110	142.00	94.00	9005490111100
0.4409			11.200	142.00	94.00	9005490112000
0.4449			11.300	142.00	94.00	9005490113000
0.4488			11.400	142.00	94.00	9005490114000
0.4528			11.500	142.00	94.00	9005490115000
0.4531	29/64		11.510	142.00	94.00	9005490115100
0.4567			11.600	142.00	94.00	9005490116000
0.4606			11.700	142.00	94.00	9005490117000
0.4626			11.750	142.00	94.00	9005490117500
0.4646			11.800	142.00	94.00	9005490118000

Dec. inch	Diameter (d1)		I1 mm	I2 mm	EDP #	
	Fract. inch	Wire / letter				
0.4685			11.900	151.00	101.00	9005490119000
0.4689	15/32		11.910	151.00	101.00	9005490119100
0.4724			12.000	151.00	101.00	9005490120000
0.4764			12.100	151.00	101.00	9005490121000
0.4783			12.150	151.00	101.00	9005490121500
0.4803			12.200	151.00	101.00	9005490122000
0.4843	31/64		12.300	151.00	101.00	9005490123000
0.4921			12.500	151.00	101.00	9005490125000
0.5000	1/2		12.700	151.00	101.00	9005490127000
0.5020			12.750	151.00	101.00	9005490127500
0.5039			12.800	151.00	101.00	9005490128000
0.5079			12.900	151.00	101.00	9005490129000
0.5118			13.000	151.00	101.00	9005490130000
0.5157	33/64		13.100	151.00	101.00	9005490131000
0.5197			13.200	151.00	101.00	9005490132000
0.5311	17/32		13.490	160.00	108.00	9005490134900
0.5315			13.500	160.00	108.00	9005490135000
0.5354			13.600	160.00	108.00	9005490136000
0.5394			13.700	160.00	108.00	9005490137000
0.5469	35/64		13.890	160.00	108.00	9005490138900
0.5512			14.000	160.00	108.00	9005490140000
0.5626	9/16		14.290	169.00	114.00	9005490142900
0.5669			14.400	169.00	114.00	9005490144000
0.5709			14.500	169.00	114.00	9005490145000
0.5780	37/64		14.680	169.00	114.00	9005490146800
0.5906			15.000	169.00	114.00	9005490150000
0.5937	19/32		15.080	178.00	120.00	9005490150800
0.6094	39/64		15.480	178.00	120.00	9005490154800
0.6102			15.500	178.00	120.00	9005490155000
0.6201			15.750	178.00	120.00	9005490157500
0.6248	5/8		15.870	178.00	120.00	9005490158700
0.6299			16.000	178.00	120.00	9005490160000

Alternative Drill Series:

- #652 HSS, GT100, 5xD, 118 pt, TiN
- #622 Cobalt, GT100, 5xD, 130 pt, Bright/Nitrided lands > 2.36
- #658 Cobalt, GT100, 5xD, 130 pt, TiN
- #530 PM Cobalt, GT500, 5xD, 130 pt, FIREX®

5xD



Nitrided lands/polished flutes >2.36mm dia.



External Coolant



Straight Shank

Speeds & Feeds information pg 441

Series 550

GT100 Parabolic, LH helix

HSS, GT 100, jobber length, 130° point, Form A web thinned all dia., standard straight shank, LH cut

Cut / Shank Dia. = h8 tolerance range

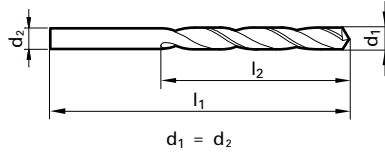

Application Materials:

- General Steels/Brass
- Aluminum & Alloys
- Cast Iron
- Universal Steels

Twist Drills

Dec. inch	Diameter (d1)		l1 mm	l2 mm	EDP #
	Fract. inch	Wire / letter			
0.0394			34.00	12.00	9005500010000
0.0512			38.00	16.00	9005500013000
0.0520		55	38.00	16.00	9005500013200
0.0531			40.00	18.00	9005500013500
0.0551		54	40.00	18.00	9005500014000
0.0571			40.00	18.00	9005500014500
0.0587			40.00	18.00	9005500014900
0.0591			40.00	18.00	9005500015000
0.0594		53	43.00	20.00	9005500015100
0.0610			43.00	20.00	9005500015500
0.0622			43.00	20.00	9005500015800
0.0626	1/16		43.00	20.00	9005500015900
0.0630			43.00	20.00	9005500016000
0.0650			43.00	20.00	9005500016500
0.0657			43.00	20.00	9005500016700
0.0669		51	43.00	20.00	9005500017000
0.0689			46.00	22.00	9005500017500
0.0701		50	46.00	22.00	9005500017800
0.0709			46.00	22.00	9005500018000
0.0728		49	46.00	22.00	9005500018500
0.0748			46.00	22.00	9005500019000
0.0768			49.00	24.00	9005500019500
0.0780	5/64		49.00	24.00	9005500019800
0.0783		47	49.00	24.00	9005500019900
0.0787			49.00	24.00	9005500020000
0.0807			49.00	24.00	9005500020500
0.0819		45	49.00	24.00	9005500020800
0.0827			49.00	24.00	9005500021000
0.0846			53.00	27.00	9005500021500
0.0866			53.00	27.00	9005500022000
0.0886			53.00	27.00	9005500022500
0.0890		43	53.00	27.00	9005500022600
0.0906			53.00	27.00	9005500023000
0.0917			53.00	27.00	9005500023300
0.0925			53.00	27.00	9005500023500
0.0933		42	57.00	30.00	9005500023700
0.0937	3/32		57.00	30.00	9005500023800
0.0945			57.00	30.00	9005500024000
0.0980		40	57.00	30.00	9005500024900
0.0984			57.00	30.00	9005500025000
0.0996		39	57.00	30.00	9005500025300
0.1004			57.00	30.00	9005500025500
0.1016		38	57.00	30.00	9005500025800
0.1024			57.00	30.00	9005500026000
0.1039		37	57.00	30.00	9005500026400
0.1043			57.00	30.00	9005500026500
0.1051			61.00	33.00	9005500026700
0.1063			61.00	33.00	9005500027000
0.1083			61.00	33.00	9005500027500
0.1094	7/64		61.00	33.00	9005500027800
0.1098		35	61.00	33.00	9005500027900
0.1102			61.00	33.00	9005500028000
0.1110		34	61.00	33.00	9005500028200
0.1130		33	61.00	33.00	9005500028700
0.1142			61.00	33.00	9005500029000

Dec. inch	Diameter (d1)		l1 mm	l2 mm	EDP #
	Fract. inch	Wire / letter			
0.1161		32	61.00	33.00	9005500029500
0.1181			61.00	33.00	9005500030000
0.1189			65.00	36.00	9005500030200
0.1201		31	65.00	36.00	9005500030500
0.1220			65.00	36.00	9005500031000
0.1240			65.00	36.00	9005500031500
0.1248	1/8		65.00	36.00	9005500031700
0.1260			65.00	36.00	9005500032000
0.1280			65.00	36.00	9005500032500
0.1283		30	65.00	36.00	9005500032600
0.1299			65.00	36.00	9005500033000
0.1319			65.00	36.00	9005500033500
0.1339			70.00	39.00	9005500034000
0.1358		29	70.00	39.00	9005500034500
0.1378			70.00	39.00	9005500035000
0.1406	9/64	28	70.00	39.00	9005500035700
0.1417			70.00	39.00	9005500036000
0.1441		27	70.00	39.00	9005500036600
0.1457			70.00	39.00	9005500037000
0.1476			70.00	39.00	9005500037500
0.1496		25	75.00	43.00	9005500038000
0.1516			75.00	43.00	9005500038500
0.1520		24	75.00	43.00	9005500038600
0.1535			75.00	43.00	9005500039000
0.1563	5/32		75.00	43.00	9005500039700
0.1571		22	75.00	43.00	9005500039900
0.1575			75.00	43.00	9005500040000
0.1591		21	75.00	43.00	9005500040400
0.1614			75.00	43.00	9005500041000
0.1654			75.00	43.00	9005500042000
0.1693		18	80.00	47.00	9005500043000
0.1713			80.00	47.00	9005500043500
0.1720	11/64		80.00	47.00	9005500043700
0.1732			80.00	47.00	9005500044000
0.1752			80.00	47.00	9005500044500
0.1772		16	80.00	47.00	9005500045000
0.1811			80.00	47.00	9005500046000
0.1819		14	80.00	47.00	9005500046200
0.1850		13	80.00	47.00	9005500047000
0.1874	3/16		86.00	52.00	9005500047600
0.1890		12	86.00	52.00	9005500048000
0.1909		11	86.00	52.00	9005500048500
0.1929			86.00	52.00	9005500049000
0.1961		9	86.00	52.00	9005500049800
0.1969			86.00	52.00	9005500050000
0.1992		8	86.00	52.00	9005500050600
0.2008			86.00	52.00	9005500051000
0.2031	13/64		86.00	52.00	9005500051600
0.2047			86.00	52.00	9005500052000
0.2087			86.00	52.00	9005500053000
0.2126			93.00	57.00	9005500054000
0.2165			93.00	57.00	9005500055000
0.2189	7/32		93.00	57.00	9005500055600
0.2205			93.00	57.00	9005500056000
0.2244			93.00	57.00	9005500057000

*Items listed in red are non-stocked items, and may take 2 - 6 weeks to receive

Series 550

Speeds & Feeds information pg 441

Twist Drills

Dec. inch	Diameter (d1)		l1 mm	l2 mm	EDP #	
	Fract. inch	Wire / letter				
0.2264			5.750	93.00	57.00	9005500057500
0.2280		1	5.790	93.00	57.00	9005500057900
0.2283			5.800	93.00	57.00	9005500058000
0.2323			5.900	93.00	57.00	9005500059000
0.2343	15/64		5.950	93.00	57.00	9005500059500
0.2362			6.000	93.00	57.00	9005500060000
0.2382			6.050	101.00	63.00	9005500060500
0.2402			6.100	101.00	63.00	9005500061000
0.2441			6.200	101.00	63.00	9005500062000
0.2461		D	6.250	101.00	63.00	9005500062500
0.2480			6.300	101.00	63.00	9005500063000
0.2500	1/4	E	6.350	101.00	63.00	9005500063500
0.2520			6.400	101.00	63.00	9005500064000
0.2559			6.500	101.00	63.00	9005500065000
0.2598			6.600	101.00	63.00	9005500066000
0.2638			6.700	101.00	63.00	9005500067000
0.2657	17/64	H	6.750	109.00	69.00	9005500067500
0.2677			6.800	109.00	69.00	9005500068000
0.2717		I	6.900	109.00	69.00	9005500069000
0.2756			7.000	109.00	69.00	9005500070000
0.2795			7.100	109.00	69.00	9005500071000
0.2811	9/32	K	7.140	109.00	69.00	9005500071400
0.2835			7.200	109.00	69.00	9005500072000
0.2874			7.300	109.00	69.00	9005500073000
0.2913			7.400	109.00	69.00	9005500074000
0.2953			7.500	109.00	69.00	9005500075000
0.2969	19/64		7.540	109.00	69.00	9005500075400
0.2992			7.600	117.00	75.00	9005500076000
0.3031			7.700	117.00	75.00	9005500077000
0.3071			7.800	117.00	75.00	9005500078000
0.3110			7.900	117.00	75.00	9005500079000
0.3126	5/16		7.940	117.00	75.00	9005500079400
0.3150			8.000	117.00	75.00	9005500080000
0.3189			8.100	117.00	75.00	9005500081000
0.3228		P	8.200	117.00	75.00	9005500082000
0.3268			8.300	117.00	75.00	9005500083000
0.3280	21/64		8.330	117.00	75.00	9005500083300
0.3307			8.400	117.00	75.00	9005500084000

Dec. inch	Diameter (d1)		l1 mm	l2 mm	EDP #	
	Fract. inch	Wire / letter				
0.3346			8.500	117.00	75.00	9005500085000
0.3386			8.600	125.00	81.00	9005500086000
0.3425			8.700	125.00	81.00	9005500087000
0.3437	11/32		8.730	125.00	81.00	9005500087300
0.3465			8.800	125.00	81.00	9005500088000
0.3504			8.900	125.00	81.00	9005500089000
0.3543			9.000	125.00	81.00	9005500090000
0.3594	23/64		9.130	125.00	81.00	9005500091300
0.3622			9.200	125.00	81.00	9005500092000
0.3661			9.300	125.00	81.00	9005500093000
0.3701			9.400	125.00	81.00	9005500094000
0.3740			9.500	125.00	81.00	9005500095000
0.3748	3/8		9.520	133.00	87.00	9005500095200
0.3780			9.600	133.00	87.00	9005500096000
0.3819			9.700	133.00	87.00	9005500097000
0.3858		W	9.800	133.00	87.00	9005500098000
0.3898			9.900	133.00	87.00	9005500099000
0.3937			10.000	133.00	87.00	9005500100000
0.3976			10.100	133.00	87.00	9005500101000
0.4016			10.200	133.00	87.00	9005500102000
0.4055			10.300	133.00	87.00	9005500103000
0.4134			10.500	133.00	87.00	9005500105000
0.4252			10.800	142.00	94.00	9005500108000
0.4331			11.000	142.00	94.00	9005500110000
0.4370			11.100	142.00	94.00	9005500111000
0.4374	7/16		11.110	142.00	94.00	9005500111100
0.4528			11.500	142.00	94.00	9005500115000
0.4606			11.700	142.00	94.00	9005500117000
0.4724			12.000	151.00	101.00	9005500120000
0.4921			12.500	151.00	101.00	9005500125000
0.5000	1/2		12.700	151.00	101.00	9005500127000

Alternative Drill Series:

#208 HSS, GP, LH helix, 5xD, 118 pt, Bright/ Steam Oxide > 6.00

10xD

Series 551

GT 100 Parabolic

HSS, GT 100 deep hole, bushing length, 130° point, Form A web thinned all dia., Morse Taper shank, RH helix

Cut / Shank Dia. = h8 tolerance range

Application Materials:

-  General Steels/Brass
-  Aluminum & Alloys
-  Universal Steels

Twist Drills



Nitrided lands / steam oxide >16 mm



External Coolant

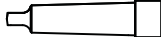

Morse Taper Shank

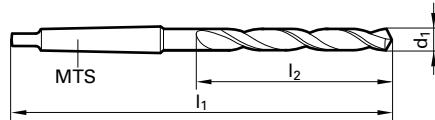

Speeds & Feeds information pg 441

Dec. inch	Diameter (d1)			Shank Size	l1 mm	l2 mm	EDP #
	Fract. inch	Wire / letter	mm				
0.2362			6.000	MTS 1	161.00	80.00	9005510060000
0.2559			6.500	MTS 1	167.00	86.00	9005510065000
0.2657	17/64	H	6.750	MTS 1	174.00	93.00	9005510067500
0.2953			7.500	MTS 1	174.00	93.00	9005510075000
0.3126	5/16		7.940	MTS 1	181.00	100.00	9005510079400
0.3280	21/64		8.330	MTS 1	181.00	100.00	9005510083300
0.3346			8.500	MTS 1	181.00	100.00	9005510085000
0.3543			9.000	MTS 1	188.00	107.00	9005510090000
0.3740			9.500	MTS 1	188.00	107.00	9005510095000
0.3748	3/8		9.520	MTS 1	197.00	116.00	9005510095200
0.3898			9.900	MTS 1	197.00	116.00	9005510099000
0.3906			9.920	MTS 1	197.00	116.00	9005510099200
0.3937			10.000	MTS 1	197.00	116.00	9005510100000
0.4016			10.200	MTS 1	197.00	116.00	9005510102000
0.4035			10.250	MTS 1	197.00	116.00	9005510102500
0.4055			10.300	MTS 1	197.00	116.00	9005510103000
0.4063	13/32		10.320	MTS 1	197.00	116.00	9005510103200
0.4134			10.500	MTS 1	197.00	116.00	9005510105000
0.4173			10.600	MTS 1	197.00	116.00	9005510106000
0.4220	27/64		10.720	MTS 1	206.00	125.00	9005510107200
0.4331			11.000	MTS 1	206.00	125.00	9005510110000
0.4374	7/16		11.110	MTS 1	206.00	125.00	9005510111100
0.4409			11.200	MTS 1	206.00	125.00	9005510112000
0.4528			11.500	MTS 1	206.00	125.00	9005510115000
0.4531	29/64		11.510	MTS 1	206.00	125.00	9005510115100
0.4646			11.800	MTS 1	206.00	125.00	9005510118000
0.4689	15/32		11.910	MTS 1	215.00	134.00	9005510119100
0.4724			12.000	MTS 1	215.00	134.00	9005510120000
0.4803			12.200	MTS 1	215.00	134.00	9005510122000
0.4843	31/64		12.300	MTS 1	215.00	134.00	9005510123000
0.4921			12.500	MTS 1	215.00	134.00	9005510125000
0.5000	1/2		12.700	MTS 1	215.00	134.00	9005510127000
0.5039			12.800	MTS 1	215.00	134.00	9005510128000
0.5118			13.000	MTS 1	215.00	134.00	9005510130000
0.5157	33/64		13.100	MTS 1	215.00	134.00	9005510131000
0.5197			13.200	MTS 1	215.00	134.00	9005510132000
0.5311	17/32		13.490	MTS 1	223.00	142.00	9005510134900
0.5315			13.500	MTS 1	223.00	142.00	9005510135000
0.5433			13.800	MTS 1	223.00	142.00	9005510138000

Dec. inch	Diameter (d1)			Shank Size	l1 mm	l2 mm	EDP #
	Fract. inch	Wire / letter	mm				
0.5469	35/64		13.890	MTS 1	223.00	142.00	9005510138900
0.5512			14.000	MTS 1	223.00	142.00	9005510140000
0.5591			14.200	MTS 2	245.00	147.00	9005510142000
0.5626	9/16		14.290	MTS 2	245.00	147.00	9005510142900
0.5709			14.500	MTS 2	245.00	147.00	9005510145000
0.5807			14.750	MTS 2	245.00	147.00	9005510147500
0.5906			15.000	MTS 2	245.00	147.00	9005510150000
0.6004			15.250	MTS 2	251.00	153.00	9005510152500
0.6094	39/64		15.480	MTS 2	251.00	153.00	9005510154800
0.6102			15.500	MTS 2	251.00	153.00	9005510155000
0.6201			15.750	MTS 2	251.00	153.00	9005510157500
0.6248	5/8		15.870	MTS 2	251.00	153.00	9005510158700
0.6299			16.000	MTS 2	251.00	153.00	9005510160000
0.6406	41/64		16.270	MTS 2	257.00	159.00	9005510162700
0.6496			16.500	MTS 2	257.00	159.00	9005510165000
0.6563	21/32		16.670	MTS 2	257.00	159.00	9005510166700
0.6614			16.800	MTS 2	257.00	159.00	9005510168000
0.6693			17.000	MTS 2	257.00	159.00	9005510170000
0.6874	11/16		17.460	MTS 2	263.00	165.00	9005510174600
0.6890			17.500	MTS 2	263.00	165.00	9005510175000
0.7087			18.000	MTS 2	263.00	165.00	9005510180000
0.7189	23/32		18.260	MTS 2	269.00	171.00	9005510182600
0.7480			19.000	MTS 2	269.00	171.00	9005510190000
0.7500	3/4		19.050	MTS 2	275.00	177.00	9005510190500
0.7657	49/64		19.450	MTS 2	275.00	177.00	9005510194500
0.7677			19.500	MTS 2	275.00	177.00	9005510195000
0.7811	25/32		19.840	MTS 2	275.00	177.00	9005510198400
0.9374	15/16		23.810	MTS 3	327.00	206.00	9005510238100
1.1417			29.000	MTS 3	351.00	230.00	9005510290000
1.1874	1 3/16		30.160	MTS 3	360.00	239.00	9005510301600
1.2008			30.500	MTS 3	360.00	239.00	9005510305000
1.2205			31.000	MTS 3	360.00	239.00	9005510310000
1.2402			31.500	MTS 3	360.00	239.00	9005510315000

Alternative Drill Series:

#656 HSS, GT100, 10xD, 130 pt, TiN

*Items listed in red are non-stocked items, and may take 2 - 6 weeks to receive

3xD

Twist Drills



Nitrided lands >2.36mm
steam oxide >16mm



External Coolant



Straight Shank

Speeds & Feeds
information pg 442

Series 552

GT80 Parabolic

HSS, GT 80, stub length, 130° point, Special web thinned all dia.,
standard straight shank, RH helix

Cut / Shank Dia. = h8 tolerance range

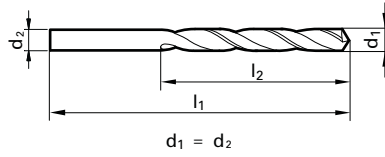

$d_1 = d_2$

Application Materials:



General Steels/
Brass



Aluminum & Alloys



Universal Steels

Diameter (d1)		Wire / letter	mm	l1 mm	l2 mm	EDP #
Dec. inch	Fract. inch					
0.0394			1.000	26.00	6.00	9005520010000
0.0402		60	1.020	26.00	6.00	9005520010200
0.0409		59	1.040	26.00	6.00	9005520010400
0.0413			1.050	26.00	6.00	9005520010500
0.0421		58	1.070	28.00	7.00	9005520010700
0.0429		57	1.090	28.00	7.00	9005520010900
0.0433			1.100	28.00	7.00	9005520011000
0.0453			1.150	28.00	7.00	9005520011500
0.0465		56	1.180	28.00	7.00	9005520011800
0.0469	3/64		1.190	28.00	7.00	9005520011900
0.0472			1.200	28.00	7.00	9005520012000
0.0492			1.250	28.00	7.00	9005520012500
0.0512			1.300	28.00	7.00	9005520013000
0.0520		55	1.320	28.00	7.00	9005520013200
0.0531			1.350	32.00	9.00	9005520013500
0.0551		54	1.400	32.00	9.00	9005520014000
0.0571			1.450	32.00	9.00	9005520014500
0.0591			1.500	32.00	9.00	9005520015000
0.0594		53	1.510	34.00	10.00	9005520015100
0.0602			1.530	34.00	10.00	9005520015300
0.0610			1.550	34.00	10.00	9005520015500
0.0626	1/16		1.590	34.00	10.00	9005520015900
0.0630			1.600	34.00	10.00	9005520016000
0.0634		52	1.610	34.00	10.00	9005520016100
0.0650			1.650	34.00	10.00	9005520016500
0.0669		51	1.700	34.00	10.00	9005520017000
0.0681			1.730	36.00	11.00	9005520017300
0.0689			1.750	36.00	11.00	9005520017500
0.0701		50	1.780	36.00	11.00	9005520017800
0.0709			1.800	36.00	11.00	9005520018000
0.0717			1.820	36.00	11.00	9005520018200
0.0728		49	1.850	36.00	11.00	9005520018500
0.0748			1.900	36.00	11.00	9005520019000
0.0760		48	1.930	38.00	12.00	9005520019300
0.0768			1.950	38.00	12.00	9005520019500
0.0780	5/64		1.980	38.00	12.00	9005520019800
0.0783		47	1.990	38.00	12.00	9005520019900
0.0787			2.000	38.00	12.00	9005520020000
0.0807			2.050	38.00	12.00	9005520020500
0.0811		46	2.060	38.00	12.00	9005520020600
0.0819		45	2.080	38.00	12.00	9005520020800
0.0827			2.100	38.00	12.00	9005520021000
0.0839			2.130	40.00	13.00	9005520021300
0.0846			2.150	40.00	13.00	9005520021500
0.0858		44	2.180	40.00	13.00	9005520021800
0.0866			2.200	40.00	13.00	9005520022000
0.0886			2.250	40.00	13.00	9005520022500
0.0890		43	2.260	40.00	13.00	9005520022600
0.0906			2.300	40.00	13.00	9005520023000
0.0913			2.320	40.00	13.00	9005520023200
0.0925			2.350	40.00	13.00	9005520023500
0.0933		42	2.370	43.00	14.00	9005520023700
0.0937	3/32		2.380	43.00	14.00	9005520023800
0.0945			2.400	43.00	14.00	9005520024000

Diameter (d1)		Wire / letter	mm	l1 mm	l2 mm	EDP #
Dec. inch	Fract. inch					
0.0961		41	2.440	43.00	14.00	9005520024400
0.0965			2.450	43.00	14.00	9005520024500
0.0980		40	2.490	43.00	14.00	9005520024900
0.0984			2.500	43.00	14.00	9005520025000
0.0996		39	2.530	43.00	14.00	9005520025300
0.1004			2.550	43.00	14.00	9005520025500
0.1016		38	2.580	43.00	14.00	9005520025800
0.1024			2.600	43.00	14.00	9005520026000
0.1039		37	2.640	43.00	14.00	9005520026400
0.1043			2.650	43.00	14.00	9005520026500
0.1063			2.700	46.00	16.00	9005520027000
0.1067		36	2.710	46.00	16.00	9005520027100
0.1083			2.750	46.00	16.00	9005520027500
0.1094	7/64		2.780	46.00	16.00	9005520027800
0.1098		35	2.790	46.00	16.00	9005520027900
0.1102			2.800	46.00	16.00	9005520028000
0.1110		34	2.820	46.00	16.00	9005520028200
0.1130		33	2.870	46.00	16.00	9005520028700
0.1142			2.900	46.00	16.00	9005520029000
0.1161		32	2.950	46.00	16.00	9005520029500
0.1181			3.000	46.00	16.00	9005520030000
0.1201		31	3.050	49.00	18.00	9005520030500
0.1220			3.100	49.00	18.00	9005520031000
0.1240			3.150	49.00	18.00	9005520031500
0.1248	1/8		3.170	49.00	18.00	9005520031700
0.1260			3.200	49.00	18.00	9005520032000
0.1280			3.250	49.00	18.00	9005520032500
0.1283		30	3.260	49.00	18.00	9005520032600
0.1299			3.300	49.00	18.00	9005520033000
0.1319			3.350	49.00	18.00	9005520033500
0.1339			3.400	52.00	20.00	9005520034000
0.1358		29	3.450	52.00	20.00	9005520034500
0.1378			3.500	52.00	20.00	9005520035000
0.1398			3.550	52.00	20.00	9005520035500
0.1406	9/64	28	3.570	52.00	20.00	9005520035700
0.1417			3.600	52.00	20.00	9005520036000
0.1437			3.650	52.00	20.00	9005520036500
0.1441		27	3.660	52.00	20.00	9005520036600
0.1457			3.700	52.00	20.00	9005520037000
0.1469		26	3.730	52.00	20.00	9005520037300
0.1476			3.750	52.00	20.00	9005520037500
0.1496		25	3.800	55.00	22.00	9005520038000
0.1520		24	3.860	55.00	22.00	9005520038600
0.1535			3.900	55.00	22.00	9005520039000
0.1539		23	3.910	55.00	22.00	9005520039100
0.1555			3.950	55.00	22.00	9005520039500
0.1563	5/32		3.970	55.00	22.00	9005520039700
0.1571			3.990	55.00	22.00	9005520039900
0.1575			4.000	55.00	22.00	9005520040000
0.1591		21	4.040	55.00	22.00	9005520040400
0.1594			4.050	55.00	22.00	9005520040500
0.1610		20	4.090	55.00	22.00	9005520040900
0.1614			4.100	55.00	22.00	9005520041000
0.1634			4.150	55.00	22.00	9005520041500

Series 552

Speeds & Feeds information pg 442

Dec. inch	Diameter (d1)		l1 mm	l2 mm	EDP #	
	Fract. inch	Wire / letter				
0.5512			14.000	107.00	54.00	9005520140000
0.5626	9/16		14.290	111.00	56.00	9005520142900
0.5709			14.500	111.00	56.00	9005520145000
0.5780	37/64		14.680	111.00	56.00	9005520146800
0.5906			15.000	111.00	56.00	9005520150000
0.5937	19/32		15.080	115.00	58.00	9005520150800
0.6094	39/64		15.480	115.00	58.00	9005520154800
0.6102			15.500	115.00	58.00	9005520155000
0.6248	5/8		15.870	115.00	58.00	9005520158700
0.6299			16.000	115.00	58.00	9005520160000
0.6406	41/64		16.270	119.00	60.00	9005520162700
0.6496			16.500	119.00	60.00	9005520165000
0.6693			17.000	119.00	60.00	9005520170000
0.6720	43/64		17.070	123.00	62.00	9005520170700
0.6874	11/16		17.460	123.00	62.00	9005520174600
0.7031	45/64		17.860	123.00	62.00	9005520178600

Dec. inch	Diameter (d1)		l1 mm	l2 mm	EDP #	
	Fract. inch	Wire / letter				
0.7087			18.000	123.00	62.00	9005520180000
0.7189	23/32		18.260	127.00	64.00	9005520182600
0.7480			19.000	127.00	64.00	9005520190000
0.7500	3/4		19.050	131.00	66.00	9005520190500
0.7811	25/32		19.840	131.00	66.00	9005520198400
0.7874			20.000	131.00	66.00	9005520200000

Alternative Drill Series:

- #225 HSS, GT80, 3xD, 130 pt, Bright
- #553 HSS, GT100, 3xD, 130 pt, LH helix, Bright/Nitrided lands > 2.36
- #5521 PM Cobalt, GT500, 3xD, 130 pt, TiN
- #515 PM Cobalt, GT500, 3xD, 130 pt, FIREX®

3xD



Nitrided lands >2.36mm
steam oxide >16mm



External Coolant

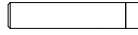

Straight Shank

Speeds & Feeds
information pg 442

Series 553

GT80 Parabolic, LH helix

HSS, GT 80, stub length, 130° point, special web thinned all dia.,
standard straight shank, LH cut

Cut / Shank Dia. = h8 tolerance range

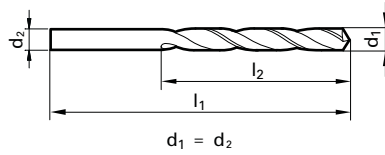

Application Materials:



General Steels/
Brass



Aluminum & Alloys



Universal Steels

Twist Drills

Dec. inch	Diameter (d1)		l1 mm	l2 mm	EDP #
	Fract. inch	Wire / letter			
0.0394			26.00	6.00	9005530010000
0.0402		60	26.00	6.00	9005530010200
0.0421		58	28.00	7.00	9005530010700
0.0429		57	28.00	7.00	9005530010900
0.0433			28.00	7.00	9005530011000
0.0453			28.00	7.00	9005530011500
0.0465		56	28.00	7.00	9005530011800
0.0472			28.00	7.00	9005530012000
0.0492			28.00	7.00	9005530012500
0.0512			28.00	7.00	9005530013000
0.0520		55	28.00	7.00	9005530013200
0.0531			32.00	9.00	9005530013500
0.0551		54	32.00	9.00	9005530014000
0.0571			32.00	9.00	9005530014500
0.0591			32.00	9.00	9005530015000
0.0594		53	34.00	10.00	9005530015100
0.0610			34.00	10.00	9005530015500
0.0626	1/16		34.00	10.00	9005530015900
0.0630			34.00	10.00	9005530016000
0.0634		52	34.00	10.00	9005530016100
0.0650			34.00	10.00	9005530016500
0.0669		51	34.00	10.00	9005530017000
0.0689			36.00	11.00	9005530017500
0.0701		50	36.00	11.00	9005530017800
0.0709			36.00	11.00	9005530018000
0.0728		49	36.00	11.00	9005530018500
0.0748			36.00	11.00	9005530019000
0.0760		48	38.00	12.00	9005530019300
0.0768			38.00	12.00	9005530019500
0.0780	5/64		38.00	12.00	9005530019800
0.0783		47	38.00	12.00	9005530019900
0.0787			38.00	12.00	9005530020000
0.0807			38.00	12.00	9005530020500
0.0811		46	38.00	12.00	9005530020600
0.0819		45	38.00	12.00	9005530020800
0.0858		44	40.00	13.00	9005530021800
0.0866			40.00	13.00	9005530022000
0.0886			40.00	13.00	9005530022500
0.0890		43	40.00	13.00	9005530022600
0.0906			40.00	13.00	9005530023000
0.0925			40.00	13.00	9005530023500
0.0937	3/32		43.00	14.00	9005530023800
0.0945			43.00	14.00	9005530024000
0.0961		41	43.00	14.00	9005530024400
0.0984			43.00	14.00	9005530025000
0.0996		39	43.00	14.00	9005530025300
0.1004			43.00	14.00	9005530025500
0.1016		38	43.00	14.00	9005530025800
0.1024			43.00	14.00	9005530026000
0.1039		37	43.00	14.00	9005530026400
0.1043			43.00	14.00	9005530026500
0.1067		36	46.00	16.00	9005530027100
0.1083			46.00	16.00	9005530027500
0.1094	7/64		46.00	16.00	9005530027800

Dec. inch	Diameter (d1)		l1 mm	l2 mm	EDP #
	Fract. inch	Wire / letter			
0.1098		35	46.00	16.00	9005530027900
0.1102			46.00	16.00	9005530028000
0.1110		34	46.00	16.00	9005530028200
0.1130		33	46.00	16.00	9005530028700
0.1142			46.00	16.00	9005530029000
0.1161		32	46.00	16.00	9005530029500
0.1181			46.00	16.00	9005530030000
0.1201		31	49.00	18.00	9005530030500
0.1220			49.00	18.00	9005530031000
0.1240			49.00	18.00	9005530031500
0.1248	1/8		49.00	18.00	9005530031700
0.1260			49.00	18.00	9005530032000
0.1283		30	49.00	18.00	9005530032600
0.1339			52.00	20.00	9005530034000
0.1358		29	52.00	20.00	9005530034500
0.1378			52.00	20.00	9005530035000
0.1406	9/64	28	52.00	20.00	9005530035700
0.1417			52.00	20.00	9005530036000
0.1441		27	52.00	20.00	9005530036600
0.1457			52.00	20.00	9005530037000
0.1469		26	52.00	20.00	9005530037300
0.1476			52.00	20.00	9005530037500
0.1496		25	55.00	22.00	9005530038000
0.1520		24	55.00	22.00	9005530038600
0.1535			55.00	22.00	9005530039000
0.1539		23	55.00	22.00	9005530039100
0.1555			55.00	22.00	9005530039500
0.1563	5/32		55.00	22.00	9005530039700
0.1571		22	55.00	22.00	9005530039900
0.1575			55.00	22.00	9005530040000
0.1591		21	55.00	22.00	9005530040400
0.1610		20	55.00	22.00	9005530040900
0.1634			55.00	22.00	9005530041500
0.1654			55.00	22.00	9005530042000
0.1661		19	55.00	22.00	9005530042200
0.1693		18	58.00	24.00	9005530043000
0.1720	11/64		58.00	24.00	9005530043700
0.1732			58.00	24.00	9005530044000
0.1752			58.00	24.00	9005530044500
0.1772		16	58.00	24.00	9005530045000
0.1799		15	58.00	24.00	9005530045700
0.1811			58.00	24.00	9005530046000
0.1819		14	58.00	24.00	9005530046200
0.1831			58.00	24.00	9005530046500
0.1850		13	58.00	24.00	9005530047000
0.1874	3/16		62.00	26.00	9005530047600
0.1890		12	62.00	26.00	9005530048000
0.1909		11	62.00	26.00	9005530048500
0.1937		10	62.00	26.00	9005530049200
0.1961		9	62.00	26.00	9005530049800
0.1969			62.00	26.00	9005530050000
0.1992		8	62.00	26.00	9005530050600
0.2008			62.00	26.00	9005530051000
0.2012		7	62.00	26.00	9005530051100

*Items listed in red are non-stocked items, and may take 2 - 6 weeks to receive

Series 553

Speeds & Feeds information pg 442

Twist Drills

Dec. inch	Diameter (d1)		I1 mm	I2 mm	EDP #	
	Fract. inch	Wire / letter				
0.2031	13/64		5.160	62.00	26.00	9005530051600
0.2039		6	5.180	62.00	26.00	9005530051800
0.2055		5	5.220	62.00	26.00	9005530052200
0.2087			5.300	62.00	26.00	9005530053000
0.2165			5.500	66.00	28.00	9005530055000
0.2189	7/32		5.560	66.00	28.00	9005530055600
0.2205			5.600	66.00	28.00	9005530056000
0.2209		2	5.610	66.00	28.00	9005530056100
0.2244			5.700	66.00	28.00	9005530057000
0.2280		1	5.790	66.00	28.00	9005530057900
0.2283			5.800	66.00	28.00	9005530058000
0.2323			5.900	66.00	28.00	9005530059000
0.2339		A	5.940	66.00	28.00	9005530059400
0.2343	15/64		5.950	66.00	28.00	9005530059500
0.2362			6.000	66.00	28.00	9005530060000
0.2402			6.100	70.00	31.00	9005530061000
0.2421		C	6.150	70.00	31.00	9005530061500
0.2461		D	6.250	70.00	31.00	9005530062500
0.2500	1/4	E	6.350	70.00	31.00	9005530063500
0.2559			6.500	70.00	31.00	9005530065000
0.2571		F	6.530	70.00	31.00	9005530065300
0.2598			6.600	70.00	31.00	9005530066000
0.2610		G	6.630	70.00	31.00	9005530066300
0.2657	17/64	H	6.750	74.00	34.00	9005530067500
0.2677			6.800	74.00	34.00	9005530068000
0.2717		I	6.900	74.00	34.00	9005530069000
0.2756			7.000	74.00	34.00	9005530070000
0.2768		J	7.030	74.00	34.00	9005530070300
0.2811	9/32	K	7.140	74.00	34.00	9005530071400
0.2835			7.200	74.00	34.00	9005530072000
0.2874			7.300	74.00	34.00	9005530073000
0.2902		L	7.370	74.00	34.00	9005530073700
0.2913			7.400	74.00	34.00	9005530074000
0.2949		M	7.490	74.00	34.00	9005530074900
0.2953			7.500	74.00	34.00	9005530075000
0.2969	19/64		7.540	79.00	37.00	9005530075400
0.3020		N	7.670	79.00	37.00	9005530076700
0.3031			7.700	79.00	37.00	9005530077000
0.3126	5/16		7.940	79.00	37.00	9005530079400
0.3150			8.000	79.00	37.00	9005530080000
0.3228		P	8.200	79.00	37.00	9005530082000
0.3268			8.300	79.00	37.00	9005530083000
0.3280	21/64		8.330	79.00	37.00	9005530083300

Dec. inch	Diameter (d1)		I1 mm	I2 mm	EDP #	
	Fract. inch	Wire / letter				
0.3319		Q	8.430	79.00	37.00	9005530084300
0.3346			8.500	79.00	37.00	9005530085000
0.3390		R	8.610	84.00	40.00	9005530086100
0.3437	11/32		8.730	84.00	40.00	9005530087300
0.3480		S	8.840	84.00	40.00	9005530088400
0.3543			9.000	84.00	40.00	9005530090000
0.3579		T	9.090	84.00	40.00	9005530090900
0.3594	23/64		9.130	84.00	40.00	9005530091300
0.3677		U	9.340	84.00	40.00	9005530093400
0.3740			9.500	84.00	40.00	9005530095000
0.3748	3/8		9.520	89.00	43.00	9005530095200
0.3772		V	9.580	89.00	43.00	9005530095800
0.3858		W	9.800	89.00	43.00	9005530098000
0.3906	25/64		9.920	89.00	43.00	9005530099200
0.3937			10.000	89.00	43.00	9005530100000
0.4016			10.200	89.00	43.00	9005530102000
0.4039		Y	10.260	89.00	43.00	9005530102600
0.4063	13/32		10.320	89.00	43.00	9005530103200
0.4130		Z	10.490	89.00	43.00	9005530104900
0.4134			10.500	89.00	43.00	9005530105000
0.4220	27/64		10.720	95.00	47.00	9005530107200
0.4331			11.000	95.00	47.00	9005530110000
0.4374	7/16		11.110	95.00	47.00	9005530111100
0.4528			11.500	95.00	47.00	9005530115000
0.4531	29/64		11.510	95.00	47.00	9005530115100
0.4689	15/32		11.910	102.00	51.00	9005530119100
0.4724			12.000	102.00	51.00	9005530120000
0.4843	31/64		12.300	102.00	51.00	9005530123000
0.4921			12.500	102.00	51.00	9005530125000
0.5000	1/2		12.700	102.00	51.00	9005530127000
0.5157	33/64		13.100	102.00	51.00	9005530131000
0.5311	17/32		13.490	107.00	54.00	9005530134900
0.5512			14.000	107.00	54.00	9005530140000
0.5626	9/16		14.290	111.00	56.00	9005530142900
0.6102			15.500	115.00	58.00	9005530155000
0.6248	5/8		15.870	115.00	58.00	9005530158700
0.7500	3/4		19.050	131.00	66.00	9005530190500
0.7874			20.000	131.00	66.00	9005530200000

Alternative Drill Series:

#226 HSS, GT100, LH Helix, 3xD, 118 pt, Bright/ Steam Oxide > 6.00

5xD

Series 605



Bright Finish



External Coolant



Straight Shank

Speeds & Feeds
information pg 443

Type Ti

Cobalt, Type Ti, jobber length, self-centering 130° split point, web thinned >1.0mm dia., standard straight shank, RH helix

Cut / Shank Dia. = h8 tolerance range

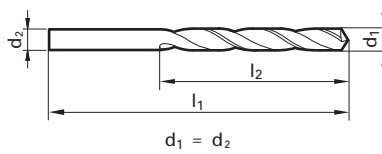

Application Materials:

- Universal Steels
- Stainless Steels
- Ti & Ni Alloys

Twist Drills



Dec. inch	Diameter (d1)			l1 mm	l2 mm	EDP #
	Fract. inch	Wire / letter	mm			
0.0118			0.300	19.00	3.00	9006050003000
0.0122		83	0.310	19.00	4.00	9006050003100
0.0126		82	0.320	19.00	4.00	9006050003200
0.0130		81	0.330	19.00	4.00	9006050003300
0.0134		80	0.340	19.00	4.00	9006050003400
0.0146		79	0.370	19.00	4.00	9006050003700
0.0157	1/64		0.400	20.00	5.00	9006050004000
0.0161		78	0.410	20.00	5.00	9006050004100
0.0173			0.440	20.00	5.00	9006050004400
0.0177			0.450	20.00	5.00	9006050004500
0.0181		77	0.460	20.00	5.00	9006050004600
0.0197			0.500	22.00	6.00	9006050005000
0.0201		76	0.510	22.00	6.00	9006050005100
0.0209		75	0.530	22.00	6.00	9006050005300
0.0217			0.550	24.00	7.00	9006050005500
0.0224		74	0.570	24.00	7.00	9006050005700
0.0228			0.580	24.00	7.00	9006050005800
0.0236			0.600	24.00	7.00	9006050006000
0.0240		73	0.610	26.00	8.00	9006050006100
0.0252		72	0.640	26.00	8.00	9006050006400
0.0256			0.650	26.00	8.00	9006050006500
0.0260		71	0.660	26.00	8.00	9006050006600
0.0276			0.700	28.00	9.00	9006050007000
0.0280		70	0.710	28.00	9.00	9006050007100
0.0283			0.720	28.00	9.00	9006050007200
0.0291		69	0.740	28.00	9.00	9006050007400
0.0295			0.750	28.00	9.00	9006050007500
0.0299			0.760	30.00	10.00	9006050007600
0.0311	1/32	68	0.790	30.00	10.00	9006050007900
0.0315			0.800	30.00	10.00	9006050008000
0.0319		67	0.810	30.00	10.00	9006050008100
0.0323			0.820	30.00	10.00	9006050008200
0.0327			0.830	30.00	10.00	9006050008300
0.0331		66	0.840	30.00	10.00	9006050008400
0.0335			0.850	30.00	10.00	9006050008500
0.0339			0.860	32.00	11.00	9006050008600
0.0343			0.870	32.00	11.00	9006050008700
0.0346			0.880	32.00	11.00	9006050008800
0.0350		65	0.890	32.00	11.00	9006050008900
0.0354			0.900	32.00	11.00	9006050009000
0.0358		64	0.910	32.00	11.00	9006050009100
0.0362			0.920	32.00	11.00	9006050009200
0.0370		63	0.940	32.00	11.00	9006050009400
0.0374			0.950	32.00	11.00	9006050009500
0.0382		62	0.970	34.00	12.00	9006050009700
0.0386			0.980	34.00	12.00	9006050009800
0.0390		61	0.990	34.00	12.00	9006050009900
0.0394			1.000	34.00	12.00	9006050010000
0.0402		60	1.020	34.00	12.00	9006050010200
0.0404			1.025	34.00	12.00	9006050010250
0.0409		59	1.040	34.00	12.00	9006050010400
0.0413			1.050	34.00	12.00	9006050010500
0.0421		58	1.070	36.00	14.00	9006050010700

Dec. inch	Diameter (d1)			l1 mm	l2 mm	EDP #
	Fract. inch	Wire / letter	mm			
0.0425			1.080	36.00	14.00	9006050010800
0.0429		57	1.090	36.00	14.00	9006050010900
0.0433			1.100	36.00	14.00	9006050011000
0.0449			1.140	36.00	14.00	9006050011400
0.0453			1.150	36.00	14.00	9006050011500
0.0457			1.160	36.00	14.00	9006050011600
0.0465		56	1.180	36.00	14.00	9006050011800
0.0469	3/64		1.190	38.00	16.00	9006050011900
0.0472			1.200	38.00	16.00	9006050012000
0.0476			1.210	38.00	16.00	9006050012100
0.0480			1.220	38.00	16.00	9006050012200
0.0484			1.230	38.00	16.00	9006050012300
0.0492			1.250	38.00	16.00	9006050012500
0.0508			1.290	38.00	16.00	9006050012900
0.0512			1.300	38.00	16.00	9006050013000
0.0520		55	1.320	38.00	16.00	9006050013200
0.0531			1.350	40.00	18.00	9006050013500
0.0551		54	1.400	40.00	18.00	9006050014000
0.0571			1.450	40.00	18.00	9006050014500
0.0575			1.460	40.00	18.00	9006050014600
0.0591			1.500	40.00	18.00	9006050015000
0.0594		53	1.510	43.00	20.00	9006050015100
0.0598			1.520	43.00	20.00	9006050015200
0.0602			1.530	43.00	20.00	9006050015300
0.0610			1.550	43.00	20.00	9006050015500
0.0626	1/16		1.590	43.00	20.00	9006050015900
0.0630			1.600	43.00	20.00	9006050016000
0.0634		52	1.610	43.00	20.00	9006050016100
0.0638			1.620	43.00	20.00	9006050016200
0.0650			1.650	43.00	20.00	9006050016500
0.0661			1.680	43.00	20.00	9006050016800
0.0669		51	1.700	43.00	20.00	9006050017000
0.0681			1.730	46.00	22.00	9006050017300
0.0689			1.750	46.00	22.00	9006050017500
0.0701		50	1.780	46.00	22.00	9006050017800
0.0709			1.800	46.00	22.00	9006050018000
0.0717			1.820	46.00	22.00	9006050018200
0.0728		49	1.850	46.00	22.00	9006050018500
0.0748			1.900	46.00	22.00	9006050019000
0.0760		48	1.930	49.00	24.00	9006050019300
0.0768			1.950	49.00	24.00	9006050019500
0.0776			1.970	49.00	24.00	9006050019700
0.0780	5/64		1.980	49.00	24.00	9006050019800
0.0783		47	1.990	49.00	24.00	9006050019900
0.0787			2.000	49.00	24.00	9006050020000
0.0795			2.020	49.00	24.00	9006050020200
0.0799			2.030	49.00	24.00	9006050020300
0.0803			2.040	49.00	24.00	9006050020400
0.0807			2.050	49.00	24.00	9006050020500
0.0811		46	2.060	49.00	24.00	9006050020600
0.0819		45	2.080	49.00	24.00	9006050020800
0.0827			2.100	49.00	24.00	9006050021000
0.0835			2.120	49.00	24.00	9006050021200

*Items listed in red are non-stocked items, and may take 2 - 6 weeks to receive

Series 605

Speeds & Feeds information pg 443

Twist Drills

Dec. inch	Diameter (d1)		I1 mm	I2 mm	EDP #	
	Fract. inch	Wire / letter				
0.2874			7.300	109.00	69.00	9006050073000
0.2902		L	7.370	109.00	69.00	9006050073700
0.2913			7.400	109.00	69.00	9006050074000
0.2949		M	7.490	109.00	69.00	9006050074900
0.2953			7.500	109.00	69.00	9006050075000
0.2969	19/64		7.540	117.00	75.00	9006050075400
0.2972			7.550	117.00	75.00	9006050075500
0.2992			7.600	117.00	75.00	9006050076000
0.3020		N	7.670	117.00	75.00	9006050076700
0.3031			7.700	117.00	75.00	9006050077000
0.3071			7.800	117.00	75.00	9006050078000
0.3110			7.900	117.00	75.00	9006050079000
0.3126	5/16		7.940	117.00	75.00	9006050079400
0.3150			8.000	117.00	75.00	9006050080000
0.3161		O	8.030	117.00	75.00	9006050080300
0.3189			8.100	117.00	75.00	9006050081000
0.3228		P	8.200	117.00	75.00	9006050082000
0.3268			8.300	117.00	75.00	9006050083000
0.3280	21/64		8.330	117.00	75.00	9006050083300
0.3307			8.400	117.00	75.00	9006050084000
0.3319		Q	8.430	117.00	75.00	9006050084300
0.3346			8.500	117.00	75.00	9006050085000
0.3386			8.600	125.00	81.00	9006050086000
0.3390		R	8.610	125.00	81.00	9006050086100
0.3425			8.700	125.00	81.00	9006050087000
0.3437	11/32		8.730	125.00	81.00	9006050087300
0.3465			8.800	125.00	81.00	9006050088000
0.3480		S	8.840	125.00	81.00	9006050088400
0.3504			8.900	125.00	81.00	9006050089000
0.3543			9.000	125.00	81.00	9006050090000
0.3579		T	9.090	125.00	81.00	9006050090900
0.3583			9.100	125.00	81.00	9006050091000
0.3594	23/64		9.130	125.00	81.00	9006050091300
0.3622			9.200	125.00	81.00	9006050092000
0.3661			9.300	125.00	81.00	9006050093000
0.3677		U	9.340	125.00	81.00	9006050093400
0.3701			9.400	125.00	81.00	9006050094000
0.3740			9.500	125.00	81.00	9006050095000
0.3748	3/8		9.520	133.00	87.00	9006050095200
0.3772		V	9.580	133.00	87.00	9006050095800
0.3780			9.600	133.00	87.00	9006050096000
0.3819			9.700	133.00	87.00	9006050097000
0.3858		W	9.800	133.00	87.00	9006050098000
0.3898			9.900	133.00	87.00	9006050099000
0.3906	25/64		9.920	133.00	87.00	9006050099200
0.3937			10.000	133.00	87.00	9006050100000
0.3969		X	10.080	133.00	87.00	9006050100800
0.4016			10.200	133.00	87.00	9006050102000
0.4039		Y	10.260	133.00	87.00	9006050102600
0.4055			10.300	133.00	87.00	9006050103000
0.4063	13/32		10.320	133.00	87.00	9006050103200
0.4130		Z	10.490	133.00	87.00	9006050104900

Dec. inch	Diameter (d1)		I1 mm	I2 mm	EDP #	
	Fract. inch	Wire / letter				
0.4134			10.500	133.00	87.00	9006050105000
0.4173			10.600	133.00	87.00	9006050106000
0.4220	27/64		10.720	142.00	94.00	9006050107200
0.4252			10.800	142.00	94.00	9006050108000
0.4331			11.000	142.00	94.00	9006050110000
0.4374	7/16		11.110	142.00	94.00	9006050111100
0.4449			11.300	142.00	94.00	9006050113000
0.4528			11.500	142.00	94.00	9006050115000
0.4531	29/64		11.510	142.00	94.00	9006050115100
0.4606			11.700	142.00	94.00	9006050117000
0.4689	15/32		11.910	151.00	101.00	9006050119100
0.4724			12.000	151.00	101.00	9006050120000
0.4803			12.200	151.00	101.00	9006050122000
0.4843	31/64		12.300	151.00	101.00	9006050123000
0.4921			12.500	151.00	101.00	9006050125000
0.5000	1/2		12.700	151.00	101.00	9006050127000
0.5118			13.000	151.00	101.00	9006050130000
0.5157	33/64		13.100	151.00	101.00	9006050131000
0.5311	17/32		13.490	160.00	108.00	9006050134900
0.5469	35/64		13.890	160.00	108.00	9006050138900
0.5512			14.000	160.00	108.00	9006050140000
0.5626	9/16		14.290	169.00	114.00	9006050142900
0.5709			14.500	169.00	114.00	9006050145000
0.5780	37/64		14.680	169.00	114.00	9006050146800
0.5906			15.000	169.00	114.00	9006050150000
0.5937	19/32		15.080	178.00	120.00	9006050150800
0.6094	39/64		15.480	178.00	120.00	9006050154800
0.6102			15.500	178.00	120.00	9006050155000
0.6248	5/8		15.870	178.00	120.00	9006050158700
0.6299			16.000	178.00	120.00	9006050160000
0.6406	41/64		16.270	178.00	120.00	9006050162700
0.6496			16.500	184.00	125.00	9006050165000
0.6563	21/32		16.670	184.00	125.00	9006050166700
0.6693			17.000	184.00	125.00	9006050170000
0.6720	43/64		17.070	191.00	130.00	9006050170700
0.6874	11/16		17.460	191.00	130.00	9006050174600
0.6890			17.500	191.00	130.00	9006050175000
0.7031	45/64		17.860	191.00	130.00	9006050178600
0.7087			18.000	191.00	130.00	9006050180000
0.7189	23/32		18.260	198.00	135.00	9006050182600
0.7343	47/64		18.650	198.00	135.00	9006050186500
0.7480			19.000	198.00	135.00	9006050190000
0.7500	3/4		19.050	205.00	140.00	9006050190500

Alternative Drill Series:

- #657 Cobalt, Ti, 5xD, 130 pt, TiN
- #305 Cobalt, GP, 5xD, 118 pt, Bright/ Steam Oxide > 2.36
- #658 Cobalt, GT100, 5xD, 130 pt, TiN
- #530 PM Cobalt, GT500, 5xD, 130 pt, FIREX®

*Items listed in red are non-stocked items, and may take 2 - 6 weeks to receive

5xD

Series 609

Three-Flute High Precision

DK 460 UF Carbide, GS 200 U three-flute high precision, 5xD, self-centering 150° point, standard straight shank, RH helix

Application Materials:

- General Steels/Brass
- Universal Steels
- Cast Iron
- Stainless Steels
- Ti & Ni Alloys



TiN Coated



External Coolant



Straight Shank

Speeds & Feeds information pg 443

Cut / Shank Dia. = h7 tolerance range

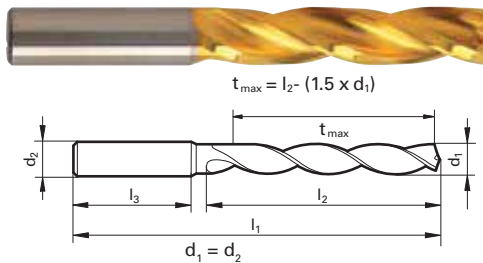

Diameter (d1)			mm	l1 mm	l2 mm	EDP #
Dec. inch	Fract. inch	Wire / letter				
0.1181			3.000	46.00	22.00	9006090030000
0.1220			3.100	49.00	24.00	90060900031000
0.1248	1/8		3.170	49.00	24.00	90060900031700
0.1260			3.200	49.00	24.00	90060900032000
0.1299			3.300	49.00	24.00	90060900033000
0.1339			3.400	52.00	27.00	90060900034000
0.1378			3.500	52.00	27.00	90060900035000
0.1406	9/64	28	3.570	52.00	27.00	90060900035700
0.1417			3.600	52.00	27.00	90060900036000
0.1457			3.700	52.00	27.00	90060900037000
0.1496		25	3.800	55.00	30.00	90060900038000
0.1535			3.900	55.00	30.00	90060900039000
0.1563	5/32		3.970	55.00	30.00	90060900039700
0.1575			4.000	55.00	30.00	90060900040000
0.1614			4.100	55.00	30.00	90060900041000
0.1654			4.200	55.00	30.00	90060900042000
0.1693		18	4.300	58.00	32.00	90060900043000
0.1720	11/64		4.370	58.00	32.00	90060900043700
0.1732			4.400	58.00	32.00	90060900044000
0.1772		16	4.500	58.00	32.00	90060900045000
0.1811			4.600	58.00	32.00	90060900046000
0.1850		13	4.700	58.00	32.00	90060900047000
0.1874	3/16		4.760	62.00	35.00	90060900047600
0.1890		12	4.800	62.00	35.00	90060900048000
0.1929			4.900	62.00	35.00	90060900049000
0.1969			5.000	62.00	35.00	90060900050000
0.2008			5.100	62.00	35.00	90060900051000
0.2031	13/64		5.160	62.00	35.00	90060900051600
0.2047			5.200	62.00	35.00	90060900052000
0.2087			5.300	62.00	35.00	90060900053000
0.2126			5.400	66.00	39.00	90060900054000
0.2165			5.500	66.00	39.00	90060900055000
0.2189	7/32		5.560	66.00	39.00	90060900055600
0.2205			5.600	66.00	39.00	90060900056000
0.2244			5.700	66.00	39.00	90060900057000
0.2283			5.800	66.00	39.00	90060900058000
0.2323			5.900	66.00	39.00	90060900059000
0.2343	15/64		5.950	66.00	39.00	90060900059500
0.2362			6.000	66.00	39.00	90060900060000
0.2402			6.100	70.00	42.00	90060900061000
0.2441			6.200	70.00	42.00	90060900062000
0.2480			6.300	70.00	42.00	90060900063000
0.2500	1/4	E	6.350	70.00	42.00	90060900063500
0.2520			6.400	70.00	42.00	90060900064000
0.2559			6.500	70.00	42.00	90060900065000
0.2598			6.600	70.00	42.00	90060900066000
0.2638			6.700	70.00	42.00	90060900067000
0.2657	17/64	H	6.750	74.00	45.00	90060900067500
0.2677			6.800	74.00	45.00	90060900068000
0.2717		I	6.900	74.00	45.00	90060900069000
0.2756			7.000	74.00	45.00	90060900070000
0.2795			7.100	74.00	45.00	90060900071000
0.2811	9/32	K	7.140	74.00	45.00	90060900071400
0.2835			7.200	74.00	45.00	90060900072000

Diameter (d1)			mm	l1 mm	l2 mm	EDP #
Dec. inch	Fract. inch	Wire / letter				
0.2874			7.300	74.00	45.00	9006090073000
0.2913			7.400	74.00	45.00	9006090074000
0.2953			7.500	74.00	45.00	9006090075000
0.2969	19/64		7.540	79.00	48.00	9006090075400
0.2992			7.600	79.00	48.00	9006090076000
0.3031			7.700	79.00	48.00	9006090077000
0.3071			7.800	79.00	48.00	9006090078000
0.3110			7.900	79.00	48.00	9006090079000
0.3126	5/16		7.940	79.00	48.00	9006090079400
0.3150			8.000	79.00	48.00	9006090080000
0.3189			8.100	79.00	48.00	9006090081000
0.3228		P	8.200	79.00	48.00	9006090082000
0.3268			8.300	79.00	48.00	9006090083000
0.3280	21/64		8.330	79.00	48.00	9006090083300
0.3307			8.400	79.00	48.00	9006090084000
0.3346			8.500	79.00	48.00	9006090085000
0.3386			8.600	84.00	52.00	9006090086000
0.3425			8.700	84.00	52.00	9006090087000
0.3437	11/32		8.730	84.00	52.00	9006090087300
0.3465			8.800	84.00	52.00	9006090088000
0.3504			8.900	84.00	52.00	9006090089000
0.3543			9.000	84.00	52.00	9006090090000
0.3583			9.100	84.00	52.00	9006090091000
0.3594	23/64		9.130	84.00	52.00	9006090091300
0.3622			9.200	84.00	52.00	9006090092000
0.3661			9.300	84.00	52.00	9006090093000
0.3701			9.400	84.00	52.00	9006090094000
0.3740			9.500	84.00	52.00	9006090095000
0.3748	3/8		9.520	89.00	55.00	9006090095200
0.3780			9.600	89.00	55.00	9006090096000
0.3819			9.700	89.00	55.00	9006090097000
0.3858		W	9.800	89.00	55.00	9006090098000
0.3898			9.900	89.00	55.00	9006090099000
0.3906	25/64		9.920	89.00	55.00	9006090099200
0.3937			10.000	89.00	55.00	9006090100000
0.3976			10.100	89.00	55.00	9006090101000
0.4016			10.200	89.00	55.00	9006090102000
0.4055			10.300	89.00	55.00	9006090103000
0.4063	13/32		10.320	89.00	55.00	9006090103200
0.4094			10.400	89.00	55.00	9006090104000
0.4134			10.500	89.00	55.00	9006090105000
0.4173			10.600	89.00	55.00	9006090106000
0.4213			10.700	95.00	60.00	9006090107000
0.4220	27/64		10.720	95.00	60.00	9006090107200
0.4252			10.800	95.00	60.00	9006090108000
0.4291			10.900	95.00	60.00	9006090109000
0.4331			11.000	95.00	60.00	9006090110000
0.4370			11.100	95.00	60.00	9006090111000
0.4374	7/16		11.110	95.00	60.00	9006090111100
0.4409			11.200	95.00	60.00	9006090112000
0.4449			11.300	95.00	60.00	9006090113000
0.4488			11.400	95.00	60.00	9006090114000
0.4528			11.500	95.00	60.00	9006090115000
0.4531	29/64		11.510	95.00	60.00	9006090115100

Series 609

Speeds & Feeds information pg 443

Twist Drills

Dec. inch	Diameter (d1)		l1 mm	l2 mm	EDP #	
	Fract. inch	Wire / letter				
0.4567			11.600	95.00	60.00	9006090116000
0.4606			11.700	95.00	60.00	9006090117000
0.4646			11.800	95.00	60.00	9006090118000
0.4685			11.900	102.00	65.00	9006090119000
0.4689	15/32		11.910	102.00	65.00	9006090119100
0.4724			12.000	102.00	65.00	9006090120000
0.4764			12.100	102.00	65.00	9006090121000
0.4803			12.200	102.00	65.00	9006090122000
0.4843	31/64		12.300	102.00	65.00	9006090123000
0.4882			12.400	102.00	65.00	9006090124000
0.4921			12.500	102.00	65.00	9006090125000
0.4961			12.600	102.00	65.00	9006090126000
0.5000	1/2		12.700	102.00	65.00	9006090127000
0.5039			12.800	102.00	65.00	9006090128000
0.5079			12.900	102.00	65.00	9006090129000
0.5118			13.000	102.00	65.00	9006090130000
0.5157	33/64		13.100	102.00	65.00	9006090131000
0.5197			13.200	102.00	65.00	9006090132000
0.5236			13.300	107.00	66.00	9006090133000
0.5276			13.400	107.00	66.00	9006090134000
0.5315			13.500	107.00	66.00	9006090135000
0.5354			13.600	107.00	66.00	9006090136000
0.5394			13.700	107.00	66.00	9006090137000
0.5433			13.800	107.00	66.00	9006090138000
0.5472			13.900	107.00	66.00	9006090139000
0.5512			14.000	107.00	66.00	9006090140000
0.5551			14.100	111.00	70.00	9006090141000
0.5591			14.200	111.00	70.00	9006090142000
0.5626	9/16		14.290	111.00	70.00	9006090142900
0.5630			14.300	111.00	70.00	9006090143000

Dec. inch	Diameter (d1)		l1 mm	l2 mm	EDP #	
	Fract. inch	Wire / letter				
0.5669			14.400	111.00	70.00	9006090144000
0.5709			14.500	111.00	70.00	9006090145000
0.5748			14.600	111.00	70.00	9006090146000
0.5787			14.700	111.00	70.00	9006090147000
0.5827			14.800	111.00	70.00	9006090148000
0.5866			14.900	111.00	70.00	9006090149000
0.5906			15.000	111.00	70.00	9006090150000
0.5945			15.100	115.00	73.00	9006090151000
0.5984			15.200	115.00	73.00	9006090152000
0.6024			15.300	115.00	73.00	9006090153000
0.6063			15.400	115.00	73.00	9006090154000
0.6102			15.500	115.00	73.00	9006090155000
0.6142			15.600	115.00	73.00	9006090156000
0.6181			15.700	115.00	73.00	9006090157000
0.6220			15.800	115.00	73.00	9006090158000
0.6248	5/8		15.870	115.00	73.00	9006090158700
0.6260			15.900	115.00	73.00	9006090159000
0.6693			17.000	119.00	73.00	9006090170000
0.7087			18.000	123.00	76.00	9006090180000
0.7283			18.500	127.00	76.00	9006090185000
0.7480			19.000	127.00	76.00	9006090190000
0.7500	3/4		19.050	131.00	79.00	9006090190500
0.7677			19.500	131.00	79.00	9006090195000
0.7874			20.000	131.00	79.00	9006090200000

Alternative Drill Series:
#1452 Carbide, GS200, 5xD, 150 U pt, Bright
#5518 Carbide, GS200, 5xD, 130 G pt, Bright

*Items listed in red are non-stocked items, and may take 2 - 6 weeks to receive

3xD

Series 610

Application Materials:

Twist Drills



Bright Finish



External Coolant



Straight Shank

Speeds & Feeds
information pg 444

Cobalt stub length, self-centering 130° split point,
web thinned all dia., standard straight shank, RH helix

Cut / Shank Dia. = h8 tolerance range

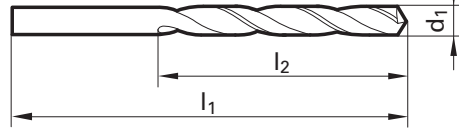

- Universal Steels
- Stainless Steels
- Cast Iron



Diameter (d1)			l1 mm	l2 mm	EDP #	
Dec. inch	Fract. inch	Wire / letter				
0.0394			26.00	6.00	900610001000	
0.0402		60	1.020	26.00	9006100010200	
0.0409		59	1.040	26.00	9006100010400	
0.0421		58	1.070	28.00	9006100010700	
0.0429		57	1.090	28.00	9006100010900	
0.0433			1.100	28.00	9006100011000	
0.0465	3/64	56	1.180	28.00	9006100011800	
0.0469			1.190	28.00	9006100011900	
0.0472			1.200	28.00	9006100012000	
0.0512			1.300	28.00	9006100013000	
0.0520		55	1.320	28.00	9006100013200	
0.0551		54	1.400	32.00	9006100014000	
0.0591			1.500	32.00	9006100015000	
0.0594		53	1.510	34.00	9006100015100	
0.0626	1/16		1.590	34.00	9006100015900	
0.0630			1.600	34.00	9006100016000	
0.0634		52	1.610	34.00	9006100016100	
0.0669		51	1.700	34.00	9006100017000	
0.0701		50	1.780	36.00	9006100017800	
0.0709			1.800	36.00	9006100018000	
0.0728	49		1.850	36.00	9006100018500	
0.0748			1.900	36.00	9006100019000	
0.0760	48		1.930	38.00	9006100019300	
0.0780			1.980	38.00	9006100019800	
0.0783	47		1.990	38.00	9006100019900	
0.0787			2.000	38.00	9006100020000	
0.0811		46	2.060	38.00	9006100020600	
0.0819		45	2.080	38.00	9006100020800	
0.0827			2.100	38.00	9006100021000	
0.0858	44		2.180	40.00	9006100021800	
0.0866			2.200	40.00	13.00	9006100022000
0.0890		43	2.260	40.00	13.00	9006100022600
0.0906			2.300	40.00	13.00	9006100023000
0.0933	42		2.370	43.00	14.00	9006100023700
0.0937			3/32	2.380	43.00	14.00
0.0945			2.400	43.00	14.00	9006100024000
0.0961		41	2.440	43.00	14.00	9006100024400
0.0980		40	2.490	43.00	14.00	9006100024900
0.0984			2.500	43.00	14.00	9006100025000
0.0996		39	2.530	43.00	14.00	9006100025300
0.1016		38	2.580	43.00	14.00	9006100025800
0.1024			2.600	43.00	14.00	9006100026000
0.1039	37		2.640	43.00	14.00	9006100026400
0.1063				2.700	46.00	16.00
0.1067	36		2.710	46.00	16.00	9006100027100
0.1094			7/64	2.780	46.00	16.00
0.1098	35		2.790	46.00	16.00	9006100027900
0.1102				2.800	46.00	16.00
0.1110		34	2.820	46.00	16.00	9006100028200
0.1130		33	2.870	46.00	16.00	9006100028700
0.1142			2.900	46.00	16.00	9006100029000
0.1161		32	2.950	46.00	16.00	9006100029500
0.1181			3.000	46.00	16.00	9006100030000
0.1201		31	3.050	49.00	18.00	9006100030500

Diameter (d1)			l1 mm	l2 mm	EDP #	
Dec. inch	Fract. inch	Wire / letter				
0.1220			49.00	18.00	9006100031000	
0.1248		1/8	3.170	49.00	18.00	9006100031700
0.1260			3.200	49.00	18.00	9006100032000
0.1283		30	3.260	49.00	18.00	9006100032600
0.1299			3.300	49.00	18.00	9006100033000
0.1339			3.400	52.00	20.00	9006100034000
0.1358	29		3.450	52.00	20.00	9006100034500
0.1378				3.500	52.00	20.00
0.1406	9/64	#28	3.570	52.00	20.00	9006100035700
0.1417				3.600	52.00	20.00
0.1441	27		3.660	52.00	20.00	9006100036600
0.1457				3.700	52.00	20.00
0.1469		26	3.730	52.00	20.00	9006100037300
0.1496		25	3.800	55.00	22.00	9006100038000
0.1520	24		3.860	55.00	22.00	9006100038600
0.1535				3.900	55.00	22.00
0.1539	23		3.910	55.00	22.00	9006100039100
0.1563			5/32	3.970	55.00	22.00
0.1571	22		3.990	55.00	22.00	9006100039900
0.1575				4.000	55.00	22.00
0.1591	21		4.040	55.00	22.00	9006100040400
0.1610			20	4.090	55.00	22.00
0.1614	20		4.100	55.00	22.00	9006100041000
0.1654				4.200	55.00	22.00
0.1661	19		4.220	55.00	22.00	9006100042200
0.1693			18	4.300	58.00	24.00
0.1720	11/64		4.370	58.00	24.00	9006100043700
0.1728			17	4.390	58.00	24.00
0.1732	16		4.400	58.00	24.00	9006100044000
0.1772				4.500	58.00	24.00
0.1799	15		4.570	58.00	24.00	9006100045700
0.1811				4.600	58.00	24.00
0.1819	14		4.620	58.00	24.00	9006100046200
0.1850			13	4.700	58.00	24.00
0.1874	3/16		4.760	62.00	26.00	9006100047600
0.1890			12	4.800	62.00	26.00
0.1909	11		4.850	62.00	26.00	9006100048500
0.1929				4.900	62.00	26.00
0.1937	10		4.920	62.00	26.00	9006100049200
0.1961			9	4.980	62.00	26.00
0.1969	8		5.000	62.00	26.00	9006100050000
0.1992				5.060	62.00	26.00
0.2008	7		5.100	62.00	26.00	9006100051000
0.2012				5.110	62.00	26.00
0.2031	13/64		5.160	62.00	26.00	9006100051600
0.2039			6	5.180	62.00	26.00
0.2047	5		5.200	62.00	26.00	9006100052000
0.2055				5.220	62.00	26.00
0.2087	4		5.300	62.00	26.00	9006100053000
0.2091				5.310	66.00	28.00
0.2126	3		5.400	66.00	28.00	9006100054000
0.2130				5.410	66.00	28.00
0.2165	7/32		5.500	66.00	28.00	9006100055000
0.2189				5.560	66.00	28.00

Series 610

Speeds & Feeds information pg 444

Twist Drills

Diameter (d1)		Wire / letter	l1 mm	l2 mm	EDP #	
Dec. inch	Fract. inch					
0.2205			5.600	66.00	28.00	9006100056000
0.2209		2	5.610	66.00	28.00	9006100056100
0.2244			5.700	66.00	28.00	9006100057000
0.2280		1	5.790	66.00	28.00	9006100057900
0.2283			5.800	66.00	28.00	9006100058000
0.2323			5.900	66.00	28.00	9006100059000
0.2339		A	5.940	66.00	28.00	9006100059400
0.2343	15/64		5.950	66.00	28.00	9006100059500
0.2362			6.000	66.00	28.00	9006100060000
0.2378		B	6.040	70.00	31.00	9006100060400
0.2402			6.100	70.00	31.00	9006100061000
0.2421		C	6.150	70.00	31.00	9006100061500
0.2441			6.200	70.00	31.00	9006100062000
0.2461		D	6.250	70.00	31.00	9006100062500
0.2480			6.300	70.00	31.00	9006100063000
0.2500	1/4	E	6.350	70.00	31.00	9006100063500
0.2520			6.400	70.00	31.00	9006100064000
0.2559			6.500	70.00	31.00	9006100065000
0.2571		F	6.530	70.00	31.00	9006100065300
0.2598			6.600	70.00	31.00	9006100066000
0.2610		G	6.630	70.00	31.00	9006100066300
0.2638			6.700	70.00	31.00	9006100067000
0.2657	17/64		6.750	74.00	34.00	9006100067500
0.2677			6.800	74.00	34.00	9006100068000
0.2717		I	6.900	74.00	34.00	9006100069000
0.2756			7.000	74.00	34.00	9006100070000
0.2768		J	7.030	74.00	34.00	9006100070300
0.2795			7.100	74.00	34.00	9006100071000
0.2811	9/32		7.140	74.00	34.00	9006100071400
0.2835			7.200	74.00	34.00	9006100072000
0.2874			7.300	74.00	34.00	9006100073000
0.2902		L	7.370	74.00	34.00	9006100073700
0.2913			7.400	74.00	34.00	9006100074000
0.2949		M	7.490	74.00	34.00	9006100074900
0.2953			7.500	74.00	34.00	9006100075000
0.2969	19/64		7.540	79.00	37.00	9006100075400
0.2992			7.600	79.00	37.00	9006100076000
0.3020		N	7.670	79.00	37.00	9006100076700
0.3031			7.700	79.00	37.00	9006100077000
0.3071			7.800	79.00	37.00	9006100078000
0.3110			7.900	79.00	37.00	9006100079000
0.3126	5/16		7.940	79.00	37.00	9006100079400
0.3150			8.000	79.00	37.00	9006100080000
0.3161		O	8.030	79.00	37.00	9006100080300
0.3189			8.100	79.00	37.00	9006100081000
0.3228		P	8.200	79.00	37.00	9006100082000
0.3268			8.300	79.00	37.00	9006100083000
0.3280	21/64		8.330	79.00	37.00	9006100083300
0.3307			8.400	79.00	37.00	9006100084000
0.3319		Q	8.430	79.00	37.00	9006100084300
0.3346			8.500	79.00	37.00	9006100085000
0.3386			8.600	84.00	40.00	9006100086000
0.3390		R	8.610	84.00	40.00	9006100086100

Diameter (d1)		Wire / letter	l1 mm	l2 mm	EDP #	
Dec. inch	Fract. inch					
0.3425			8.700	84.00	40.00	9006100087000
0.3437	11/32		8.730	84.00	40.00	9006100087300
0.3465			8.800	84.00	40.00	9006100088000
0.3480		S	8.840	84.00	40.00	9006100088400
0.3504			8.900	84.00	40.00	9006100089000
0.3543			9.000	84.00	40.00	9006100090000
0.3579		T	9.090	84.00	40.00	9006100090900
0.3583			9.100	84.00	40.00	9006100091000
0.3594	23/64		9.130	84.00	40.00	9006100091300
0.3622			9.200	84.00	40.00	9006100092000
0.3661			9.300	84.00	40.00	9006100093000
0.3677		U	9.340	84.00	40.00	9006100093400
0.3701			9.400	84.00	40.00	9006100094000
0.3740			9.500	84.00	40.00	9006100095000
0.3748	3/8		9.520	89.00	43.00	9006100095200
0.3772		V	9.580	89.00	43.00	9006100095800
0.3780			9.600	89.00	43.00	9006100096000
0.3819			9.700	89.00	43.00	9006100097000
0.3858		W	9.800	89.00	43.00	9006100098000
0.3898			9.900	89.00	43.00	9006100099000
0.3906	25/64		9.920	89.00	43.00	9006100099200
0.3937			10.000	89.00	43.00	9006100100000
0.3969		X	10.080	89.00	43.00	9006100100800
0.3976			10.100	89.00	43.00	9006100101000
0.4016			10.200	89.00	43.00	9006100102000
0.4039		Y	10.260	89.00	43.00	9006100102600
0.4055			10.300	89.00	43.00	9006100103000
0.4063	13/32		10.320	89.00	43.00	9006100103200
0.4094			10.400	89.00	43.00	9006100104000
0.4130		Z	10.490	89.00	43.00	9006100104900
0.4134			10.500	89.00	43.00	9006100105000
0.4220	27/64		10.720	95.00	47.00	9006100107200
0.4331			11.000	95.00	47.00	9006100110000
0.4374	7/16		11.110	95.00	47.00	9006100111100
0.4528			11.500	95.00	47.00	9006100115000
0.4531	29/64		11.510	95.00	47.00	9006100115100
0.4689	15/32		11.910	102.00	51.00	9006100119100
0.4724			12.000	102.00	51.00	9006100120000
0.4843	31/64		12.300	102.00	51.00	9006100123000
0.4921			12.500	102.00	51.00	9006100125000
0.5000	1/2		12.700	102.00	51.00	9006100127000
0.5118			13.000	102.00	51.00	9006100130000
0.5157	33/64		13.100	102.00	51.00	9006100131000
0.5311	17/32		13.490	107.00	54.00	9006100134900
0.5315			13.500	107.00	54.00	9006100135000
0.5512			14.000	107.00	54.00	9006100140000
0.5626	9/16		14.290	111.00	56.00	9006100142900

Alternative Drill Series:
 #5520, cobalt, GU 500, 3xD, 118 pt., TiN
 #515, PM cobalt, GT 500, 3xD, 130 pt., FIREX®

*Items listed in red are non-stocked items, and may take 2 - 6 weeks to receive

10xD



Bright Finish



External Coolant



Straight Shank

Speeds & Feeds
information pg 444

Series 617

Type Ti

Cobalt, Type Ti, taper length, self-centering 130° split point,
web thinned all dia., standard straight shank, RH helix

Cut / Shank Dia. = h8 tolerance range

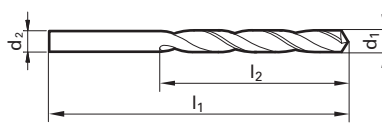
 $d_1 = d_2$

Application Materials:

- Universal Steels
- Stainless Steels
- Ti & Ni Alloys

Dec. inch	Diameter (d1)		l1 mm	l2 mm	EDP #	
	Fract. inch	Wire / letter				
0.0394			1.000	56.00	33.00	9006170010000
0.0402		60	1.020	56.00	33.00	9006170010200
0.0409		59	1.040	56.00	33.00	9006170010400
0.0421		58	1.070	60.00	37.00	9006170010700
0.0429		57	1.090	60.00	37.00	9006170010900
0.0433			1.100	60.00	37.00	9006170011000
0.0465		56	1.180	60.00	37.00	9006170011800
0.0469	3/64		1.190	65.00	41.00	9006170011900
0.0472			1.200	65.00	41.00	9006170012000
0.0512			1.300	65.00	41.00	9006170013000
0.0520		55	1.320	65.00	41.00	9006170013200
0.0551		54	1.400	70.00	45.00	9006170014000
0.0571			1.450	70.00	45.00	9006170014500
0.0591			1.500	70.00	45.00	9006170015000
0.0594		53	1.510	76.00	50.00	9006170015100
0.0626	1/16		1.590	76.00	50.00	9006170015900
0.0630			1.600	76.00	50.00	9006170016000
0.0634		52	1.610	76.00	50.00	9006170016100
0.0650			1.650	76.00	50.00	9006170016500
0.0669		51	1.700	76.00	50.00	9006170017000
0.0689			1.750	80.00	53.00	9006170017500
0.0701		50	1.780	80.00	53.00	9006170017800
0.0709			1.800	80.00	53.00	9006170018000
0.0728		49	1.850	80.00	53.00	9006170018500
0.0748			1.900	80.00	53.00	9006170019000
0.0760		48	1.930	85.00	56.00	9006170019300
0.0768			1.950	85.00	56.00	9006170019500
0.0780	5/64		1.980	85.00	56.00	9006170019800
0.0783		47	1.990	85.00	56.00	9006170019900
0.0787			2.000	85.00	56.00	9006170020000
0.0807			2.050	85.00	56.00	9006170020500
0.0811		46	2.060	85.00	56.00	9006170020600
0.0819		45	2.080	85.00	56.00	9006170020800
0.0827			2.100	85.00	56.00	9006170021000
0.0846			2.150	90.00	59.00	9006170021500
0.0858		44	2.180	90.00	59.00	9006170021800
0.0866			2.200	90.00	59.00	9006170022000
0.0890		43	2.260	90.00	59.00	9006170022600
0.0906			2.300	90.00	59.00	9006170023000
0.0933		42	2.370	95.00	62.00	9006170023700
0.0937	3/32		2.380	95.00	62.00	9006170023800
0.0945			2.400	95.00	62.00	9006170024000
0.0961		41	2.440	95.00	62.00	9006170024400
0.0965			2.450	95.00	62.00	9006170024500
0.0980		40	2.490	95.00	62.00	9006170024900
0.0984			2.500	95.00	62.00	9006170025000
0.1004			2.550	95.00	62.00	9006170025500
0.1016		38	2.580	95.00	62.00	9006170025800
0.1024			2.600	95.00	62.00	9006170026000
0.1039		37	2.640	95.00	62.00	9006170026400
0.1063			2.700	100.00	66.00	9006170027000
0.1067		36	2.710	100.00	66.00	9006170027100
0.1094	7/64		2.780	100.00	66.00	9006170027800

Dec. inch	Diameter (d1)		l1 mm	l2 mm	EDP #	
	Fract. inch	Wire / letter				
0.1098		35	2.790	100.00	66.00	9006170027900
0.1102			2.800	100.00	66.00	9006170028000
0.1110		34	2.820	100.00	66.00	9006170028200
0.1130		33	2.870	100.00	66.00	9006170028700
0.1142			2.900	100.00	66.00	9006170029000
0.1161		32	2.950	100.00	66.00	9006170029500
0.1181			3.000	100.00	66.00	9006170030000
0.1201		31	3.050	106.00	69.00	9006170030500
0.1220			3.100	106.00	69.00	9006170031000
0.1248	1/8		3.170	106.00	69.00	9006170031700
0.1260			3.200	106.00	69.00	9006170032000
0.1280			3.250	106.00	69.00	9006170032500
0.1283		30	3.260	106.00	69.00	9006170032600
0.1299			3.300	106.00	69.00	9006170033000
0.1339			3.400	112.00	73.00	9006170034000
0.1358		29	3.450	112.00	73.00	9006170034500
0.1378			3.500	112.00	73.00	9006170035000
0.1406	9/64	28	3.570	112.00	73.00	9006170035700
0.1417			3.600	112.00	73.00	9006170036000
0.1441		27	3.660	112.00	73.00	9006170036600
0.1457			3.700	112.00	73.00	9006170037000
0.1469		26	3.730	112.00	73.00	9006170037300
0.1496		25	3.800	119.00	78.00	9006170038000
0.1520		24	3.860	119.00	78.00	9006170038600
0.1535			3.900	119.00	78.00	9006170039000
0.1539		23	3.910	119.00	78.00	9006170039100
0.1563	5/32		3.970	119.00	78.00	9006170039700
0.1571		22	3.990	119.00	78.00	9006170039900
0.1575			4.000	119.00	78.00	9006170040000
0.1591		21	4.040	119.00	78.00	9006170040400
0.1594			4.050	119.00	78.00	9006170040500
0.1610		20	4.090	119.00	78.00	9006170040900
0.1614			4.100	119.00	78.00	9006170041000
0.1654			4.200	119.00	78.00	9006170042000
0.1661		19	4.220	119.00	78.00	9006170042200
0.1693		18	4.300	126.00	82.00	9006170043000
0.1720	11/64		4.370	126.00	82.00	9006170043700
0.1728		17	4.390	126.00	82.00	9006170043900
0.1732			4.400	126.00	82.00	9006170044000
0.1772		16	4.500	126.00	82.00	9006170045000
0.1799		15	4.570	126.00	82.00	9006170045700
0.1811			4.600	126.00	82.00	9006170046000
0.1819		14	4.620	126.00	82.00	9006170046200
0.1850		13	4.700	126.00	82.00	9006170047000
0.1874	3/16		4.760	132.00	87.00	9006170047600
0.1890		12	4.800	132.00	87.00	9006170048000
0.1909		11	4.850	132.00	87.00	9006170048500
0.1929			4.900	132.00	87.00	9006170049000
0.1937		10	4.920	132.00	87.00	9006170049200
0.1949			4.950	132.00	87.00	9006170049500
0.1961		9	4.980	132.00	87.00	9006170049800
0.1969			5.000	132.00	87.00	9006170050000
0.1988			5.050	132.00	87.00	9006170050500

Extra Length

#1



Nitrided lands/
polished flutes



External Coolant



Straight Shank

Speeds & Feeds
information pg 445

Series 618

GT 100 Parabolic

Cobalt, GT 100 deep hole, extra length #1, 130° point,
Form A web thinned all dia., standard straight shank, RH helix

Cut / Shank Dia. = h8 tolerance range

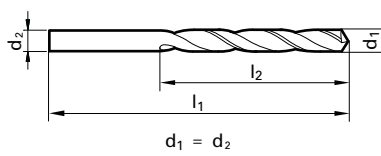

Application Materials:

-  General Steels
-  Aluminum & Alloys
-  Universal Steels

Dec. inch	Diameter (d1)		l1 mm	l2 mm	EDP #
	Fract. inch	Wire / letter			
0.1063			150.00	100.00	9006180027000
0.1142			150.00	100.00	9006180029000
0.1181			150.00	100.00	9006180030000
0.1220			155.00	105.00	9006180031000
0.1248	1/8		155.00	105.00	9006180031700
0.1260			155.00	105.00	9006180032000
0.1299			155.00	105.00	9006180033000
0.1339			165.00	115.00	9006180034000
0.1378			165.00	115.00	9006180035000
0.1417			165.00	115.00	9006180036000
0.1457			165.00	115.00	9006180037000
0.1496		25	175.00	120.00	9006180038000
0.1535			175.00	120.00	9006180039000
0.1563	5/32		175.00	120.00	9006180039700
0.1575			175.00	120.00	9006180040000
0.1614			175.00	120.00	9006180041000
0.1654			175.00	120.00	9006180042000
0.1693		18	185.00	125.00	9006180043000
0.1720	11/64		185.00	125.00	9006180043700
0.1732			185.00	125.00	9006180044000
0.1772		16	185.00	125.00	9006180045000
0.1811			185.00	125.00	9006180046000
0.1874	3/16		195.00	135.00	9006180047600
0.1890		12	195.00	135.00	9006180048000
0.1909		11	195.00	135.00	9006180048500
0.1969			195.00	135.00	9006180050000
0.2008			195.00	135.00	9006180051000
0.2031	13/64		195.00	135.00	9006180051600
0.2047			195.00	135.00	9006180052000
0.2087			195.00	135.00	9006180053000
0.2126			205.00	140.00	9006180054000
0.2165			205.00	140.00	9006180055000
0.2189	7/32		205.00	140.00	9006180055600
0.2205			205.00	140.00	9006180056000
0.2244			205.00	140.00	9006180057000
0.2283			205.00	140.00	9006180058000
0.2362			205.00	140.00	9006180060000
0.2402			215.00	150.00	9006180061000

Dec. inch	Diameter (d1)		l1 mm	l2 mm	EDP #
	Fract. inch	Wire / letter			
0.2441			215.00	150.00	9006180062000
0.2480			215.00	150.00	9006180063000
0.2500	1/4	E	215.00	150.00	9006180063500
0.2520			215.00	150.00	9006180064000
0.2559			215.00	150.00	9006180065000
0.2598			215.00	150.00	9006180066000
0.2638			215.00	150.00	9006180067000
0.2657	17/64	H	225.00	155.00	9006180067500
0.2677			225.00	155.00	9006180068000
0.2756			225.00	155.00	9006180070000
0.2811	9/32	K	225.00	155.00	9006180071400
0.2913			225.00	155.00	9006180074000
0.2953			225.00	155.00	9006180075000
0.2969	19/64		240.00	165.00	9006180075400
0.3031			240.00	165.00	9006180077000
0.3126	5/16		240.00	165.00	9006180079400
0.3150			240.00	165.00	9006180080000
0.3228		P	240.00	165.00	9006180082000
0.3280	21/64		240.00	165.00	9006180083300
0.3307			240.00	165.00	9006180084000
0.3346			240.00	165.00	9006180085000
0.3425			250.00	175.00	9006180087000
0.3437	11/32		250.00	175.00	9006180087300
0.3465			250.00	175.00	9006180088000
0.3543			250.00	175.00	9006180090000
0.3594	23/64		250.00	175.00	9006180091300
0.3701			250.00	175.00	9006180094000
0.3740			250.00	175.00	9006180095000
0.3748	3/8		265.00	185.00	9006180095200
0.3819			265.00	185.00	9006180097000
0.3937			265.00	185.00	9006180100000

Alternative Drill Series:

- #502 HSS, GT100, >10xD, 130 pt, Bright
- #670 HSS, GT100, >10xD, 130 pt, TiN
- #524 HSS, GT50, >10xD, 130 pt, Bright

Extra Length #2



Nitrided lands/
polished flutes



External Coolant



Straight Shank

Speeds & Feeds
information pg 445

Series 619

GT 100 Parabolic

Cobalt, GT 100 deep hole, extra length #2, 130° point, Form A
web thinned all dia., standard straight shank, RH helix

Cut / Shank Dia. = h8 tolerance range

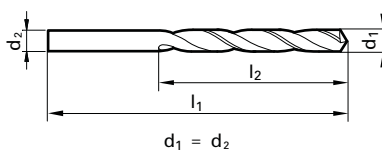

Application Materials:

-  General Steels
-  Aluminum & Alloys
-  Universal Steels

Twist Drills

Dec. inch	Diameter (d1)		mm	l1 mm	l2 mm	EDP #
	Fract. inch	Wire / letter				
0.1181			3.000	190.00	130.00	9006190030000
0.1248	1/8		3.170	200.00	135.00	9006190031700
0.1260			3.200	200.00	135.00	9006190032000
0.1299			3.300	200.00	135.00	9006190033000
0.1378			3.500	210.00	145.00	9006190035000
0.1406	9/64	28	3.570	210.00	145.00	9006190035700
0.1563	5/32		3.970	220.00	150.00	9006190039700
0.1575			4.000	220.00	150.00	9006190040000
0.1614			4.100	220.00	150.00	9006190041000
0.1654			4.200	220.00	150.00	9006190042000
0.1720	11/64		4.370	235.00	160.00	9006190043700
0.1772		16	4.500	235.00	160.00	9006190045000
0.1874	3/16		4.760	245.00	170.00	9006190047600
0.1890		12	4.800	245.00	170.00	9006190048000
0.1929			4.900	245.00	170.00	9006190049000
0.1969			5.000	245.00	170.00	9006190050000
0.2047			5.200	245.00	170.00	9006190052000
0.2165			5.500	260.00	180.00	9006190055000
0.2189	7/32		5.560	260.00	180.00	9006190055600
0.2244			5.700	260.00	180.00	9006190057000
0.2343	15/64		5.950	260.00	180.00	9006190059500
0.2362			6.000	260.00	180.00	9006190060000
0.2402			6.100	275.00	190.00	9006190061000
0.2441			6.200	275.00	190.00	9006190062000
0.2500	1/4	E	6.350	275.00	190.00	9006190063500

Dec. inch	Diameter (d1)		mm	l1 mm	l2 mm	EDP #
	Fract. inch	Wire / letter				
0.2559			6.500	275.00	190.00	9006190065000
0.2638			6.700	275.00	190.00	9006190067000
0.2657	17/64	H	6.750	290.00	200.00	9006190067500
0.2756			7.000	290.00	200.00	9006190070000
0.2811	9/32	K	7.140	290.00	200.00	9006190071400
0.2913			7.400	290.00	200.00	9006190074000
0.2953			7.500	290.00	200.00	9006190075000
0.2969	19/64		7.540	305.00	210.00	9006190075400
0.3031			7.700	305.00	210.00	9006190077000
0.3126	5/16		7.940	305.00	210.00	9006190079400
0.3150			8.000	305.00	210.00	9006190080000
0.3228		P	8.200	305.00	210.00	9006190082000
0.3346			8.500	305.00	210.00	9006190085000
0.3425			8.700	320.00	220.00	9006190087000
0.3437	11/32		8.730	320.00	220.00	9006190087300
0.3543			9.000	320.00	220.00	9006190090000
0.3740			9.500	320.00	220.00	9006190095000
0.3748	3/8		9.520	340.00	235.00	9006190095200
0.3937			10.000	340.00	235.00	9006190100000

Alternative Drill Series:

- #503 HSS, GT100, >10xD, 130 pt, Bright/Nitrided lands > 2.36
- #671 HSS, GT100, >10xD, 130 pt, TiN
- #528 HSS, GT50, >10xD, 130 pt, Bright

*Items listed in red are non-stocked items, and may take 2 - 6 weeks to receive

5xD



Nitrided lands/polished flutes >2.36mm dia.



External Coolant



Straight Shank

Speeds & Feeds
information pg 446

Series 622

GT 100 Parabolic

Cobalt, GT 100, jobber length, 130° point,
Form A web thinned all dia., standard straight shank, RH helix

Cut / Shank Dia. = h8 tolerance range

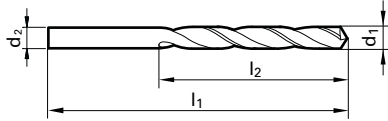

$$d_1 = d_2$$

Application Materials:



General Steels



Aluminum & Alloys



Universal Steels

Dec. inch	Diameter (d1)			l1 mm	l2 mm	EDP #
	Fract. inch	Wire / letter	mm			
0.0394			1.000	34.00	12.00	9006220010000
0.0402		60	1.020	34.00	12.00	9006220010200
0.0409		59	1.040	34.00	12.00	9006220010400
0.0413			1.050	34.00	12.00	9006220010500
0.0421		58	1.070	36.00	14.00	9006220010700
0.0429		57	1.090	36.00	14.00	9006220010900
0.0433			1.100	36.00	14.00	9006220011000
0.0453			1.150	36.00	14.00	9006220011500
0.0465		56	1.180	36.00	14.00	9006220011800
0.0469	3/64		1.190	38.00	16.00	9006220011900
0.0472			1.200	38.00	16.00	9006220012000
0.0492			1.250	38.00	16.00	9006220012500
0.0500			1.270	38.00	16.00	9006220012700
0.0512			1.300	38.00	16.00	9006220013000
0.0520		55	1.320	38.00	16.00	9006220013200
0.0531			1.350	40.00	18.00	9006220013500
0.0551		54	1.400	40.00	18.00	9006220014000
0.0563			1.430	40.00	18.00	9006220014300
0.0571			1.450	40.00	18.00	9006220014500
0.0591			1.500	40.00	18.00	9006220015000
0.0594		53	1.510	43.00	20.00	9006220015100
0.0610			1.550	43.00	20.00	9006220015500
0.0626	1/16		1.590	43.00	20.00	9006220015900
0.0630			1.600	43.00	20.00	9006220016000
0.0634		52	1.610	43.00	20.00	9006220016100
0.0650			1.650	43.00	20.00	9006220016500
0.0669		51	1.700	43.00	20.00	9006220017000
0.0701		50	1.780	46.00	22.00	9006220017800
0.0709			1.800	46.00	22.00	9006220018000
0.0728		49	1.850	46.00	22.00	9006220018500
0.0748			1.900	46.00	22.00	9006220019000
0.0756			1.920	49.00	24.00	9006220019200
0.0760		48	1.930	49.00	24.00	9006220019300
0.0768			1.950	49.00	24.00	9006220019500
0.0780	5/64		1.980	49.00	24.00	9006220019800
0.0783		47	1.990	49.00	24.00	9006220019900
0.0787			2.000	49.00	24.00	9006220020000
0.0807			2.050	49.00	24.00	9006220020500
0.0811		46	2.060	49.00	24.00	9006220020600
0.0819		45	2.080	49.00	24.00	9006220020800
0.0827			2.100	49.00	24.00	9006220021000
0.0846			2.150	53.00	27.00	9006220021500
0.0858		44	2.180	53.00	27.00	9006220021800
0.0866			2.200	53.00	27.00	9006220022000
0.0886			2.250	53.00	27.00	9006220022500
0.0890		43	2.260	53.00	27.00	9006220022600
0.0906			2.300	53.00	27.00	9006220023000
0.0925			2.350	53.00	27.00	9006220023500
0.0933		42	2.370	57.00	30.00	9006220023700
0.0937	3/32		2.380	57.00	30.00	9006220023800
0.0945			2.400	57.00	30.00	9006220024000
0.0953			2.420	57.00	30.00	9006220024200
0.0961		41	2.440	57.00	30.00	9006220024400
0.0965			2.450	57.00	30.00	9006220024500
0.0980		40	2.490	57.00	30.00	9006220024900

Dec. inch	Diameter (d1)			l1 mm	l2 mm	EDP #
	Fract. inch	Wire / letter	mm			
0.0984			2.500	57.00	30.00	9006220025000
0.0996		39	2.530	57.00	30.00	9006220025300
0.1004			2.550	57.00	30.00	9006220025500
0.1016		38	2.580	57.00	30.00	9006220025800
0.1024			2.600	57.00	30.00	9006220026000
0.1039		37	2.640	57.00	30.00	9006220026400
0.1043			2.650	57.00	30.00	9006220026500
0.1063			2.700	61.00	33.00	9006220027000
0.1067		36	2.710	61.00	33.00	9006220027100
0.1083			2.750	61.00	33.00	9006220027500
0.1094	7/64		2.780	61.00	33.00	9006220027800
0.1098		35	2.790	61.00	33.00	9006220027900
0.1102			2.800	61.00	33.00	9006220028000
0.1110		34	2.820	61.00	33.00	9006220028200
0.1122			2.850	61.00	33.00	9006220028500
0.1130		33	2.870	61.00	33.00	9006220028700
0.1142			2.900	61.00	33.00	9006220029000
0.1161		32	2.950	61.00	33.00	9006220029500
0.1181			3.000	61.00	33.00	9006220030000
0.1201		31	3.050	65.00	36.00	9006220030500
0.1220			3.100	65.00	36.00	9006220031000
0.1248	1/8		3.170	65.00	36.00	9006220031700
0.1260			3.200	65.00	36.00	9006220032000
0.1280			3.250	65.00	36.00	9006220032500
0.1283		30	3.260	65.00	36.00	9006220032600
0.1299			3.300	65.00	36.00	9006220033000
0.1339			3.400	70.00	39.00	9006220034000
0.1358		29	3.450	70.00	39.00	9006220034500
0.1378			3.500	70.00	39.00	9006220035000
0.1406	9/64	28	3.570	70.00	39.00	9006220035700
0.1417			3.600	70.00	39.00	9006220036000
0.1441		27	3.660	70.00	39.00	9006220036600
0.1457			3.700	70.00	39.00	9006220037000
0.1469		26	3.730	70.00	39.00	9006220037300
0.1496		25	3.800	75.00	43.00	9006220038000
0.1520		24	3.860	75.00	43.00	9006220038600
0.1535			3.900	75.00	43.00	9006220039000
0.1539		23	3.910	75.00	43.00	9006220039100
0.1563		5/32	3.970	75.00	43.00	9006220039700
0.1571		22	3.990	75.00	43.00	9006220039900
0.1575			4.000	75.00	43.00	9006220040000
0.1591		21	4.040	75.00	43.00	9006220040400
0.1610		20	4.090	75.00	43.00	9006220040900
0.1614			4.100	75.00	43.00	9006220041000
0.1634			4.150	75.00	43.00	9006220041500
0.1654			4.200	75.00	43.00	9006220042000
0.1661		19	4.220	75.00	43.00	9006220042200
0.1673			4.250	75.00	43.00	9006220042500
0.1693		18	4.300	80.00	47.00	9006220043000
0.1720	11/64		4.370	80.00	47.00	9006220043700
0.1728		17	4.390	80.00	47.00	9006220043900
0.1732			4.400	80.00	47.00	9006220044000
0.1772		16	4.500	80.00	47.00	9006220045000
0.1791			4.550	80.00	47.00	9006220045500
0.1799		15	4.570	80.00	47.00	9006220045700

5xD



TiN coated



External Coolant



Straight Shank

Speeds & Feeds
information pg 446

Series 651

General Purpose

HSS, general purpose (Type N), jobber length, 118° point, Form A web thinned
>2.36mm dia., standard straight shank, RH helix

Cut / Shank Dia. = h8 tolerance range

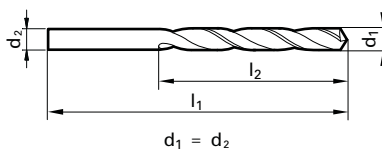

Application Materials:

- Universal Steels
- Cast Iron
- General Steels

Dec. inch	Diameter (d1)		l1 mm	l2 mm	EDP #	
	Fract. inch	Wire / letter mm				
0.0079		92	0.200	19.00	2.50	9006510002000
0.0098		87	0.250	19.00	3.00	9006510002500
0.0110		85	0.280	19.00	3.00	9006510002800
0.0118			0.300	19.00	3.00	9006510003000
0.0122		83	0.310	19.00	4.00	9006510003100
0.0130		81	0.330	19.00	4.00	9006510003300
0.0134		80	0.340	19.00	4.00	9006510003400
0.0142			0.360	19.00	4.00	9006510003600
0.0146		79	0.370	19.00	4.00	9006510003700
0.0150			0.380	19.00	4.00	9006510003800
0.0154			0.390	20.00	5.00	9006510003900
0.0157	1/64		0.400	20.00	5.00	9006510004000
0.0161		78	0.410	20.00	5.00	9006510004100
0.0165			0.420	20.00	5.00	9006510004200
0.0169			0.430	20.00	5.00	9006510004300
0.0173			0.440	20.00	5.00	9006510004400
0.0177			0.450	20.00	5.00	9006510004500
0.0181		77	0.460	20.00	5.00	9006510004600
0.0185			0.470	20.00	5.00	9006510004700
0.0189			0.480	20.00	5.00	9006510004800
0.0193			0.490	22.00	6.00	9006510004900
0.0197			0.500	22.00	6.00	9006510005000
0.0201		76	0.510	22.00	6.00	9006510005100
0.0205			0.520	22.00	6.00	9006510005200
0.0209		75	0.530	22.00	6.00	9006510005300
0.0213			0.540	24.00	7.00	9006510005400
0.0217			0.550	24.00	7.00	9006510005500
0.0224		74	0.570	24.00	7.00	9006510005700
0.0228			0.580	24.00	7.00	9006510005800
0.0232			0.590	24.00	7.00	9006510005900
0.0236			0.600	24.00	7.00	9006510006000
0.0240		73	0.610	26.00	8.00	9006510006100
0.0248			0.630	26.00	8.00	9006510006300
0.0252		72	0.640	26.00	8.00	9006510006400
0.0256			0.650	26.00	8.00	9006510006500
0.0260		71	0.660	26.00	8.00	9006510006600
0.0268			0.680	28.00	9.00	9006510006800
0.0272			0.690	28.00	9.00	9006510006900
0.0276			0.700	28.00	9.00	9006510007000
0.0280		70	0.710	28.00	9.00	9006510007100
0.0283			0.720	28.00	9.00	9006510007200
0.0291		69	0.740	28.00	9.00	9006510007400
0.0295			0.750	28.00	9.00	9006510007500
0.0303			0.770	30.00	10.00	9006510007700
0.0307			0.780	30.00	10.00	9006510007800
0.0311	1/32	68	0.790	30.00	10.00	9006510007900
0.0315			0.800	30.00	10.00	9006510008000
0.0319		67	0.810	30.00	10.00	9006510008100
0.0323			0.820	30.00	10.00	9006510008200
0.0327			0.830	30.00	10.00	9006510008300
0.0331		66	0.840	30.00	10.00	9006510008400
0.0335			0.850	30.00	10.00	9006510008500
0.0339			0.860	32.00	11.00	9006510008600
0.0346			0.880	32.00	11.00	9006510008800

Dec. inch	Diameter (d1)		l1 mm	l2 mm	EDP #	
	Fract. inch	Wire / letter mm				
0.0350		65	0.890	32.00	11.00	9006510008900
0.0354			0.900	32.00	11.00	9006510009000
0.0358		64	0.910	32.00	11.00	9006510009100
0.0362			0.920	32.00	11.00	9006510009200
0.0366			0.930	32.00	11.00	9006510009300
0.0370		63	0.940	32.00	11.00	9006510009400
0.0374			0.950	32.00	11.00	9006510009500
0.0378			0.960	34.00	12.00	9006510009600
0.0382		62	0.970	34.00	12.00	9006510009700
0.0386			0.980	34.00	12.00	9006510009800
0.0390		61	0.990	34.00	12.00	9006510009900
0.0394			1.000	34.00	12.00	9006510010000
0.0402		60	1.020	34.00	12.00	9006510010200
0.0406			1.030	34.00	12.00	9006510010300
0.0409		59	1.040	34.00	12.00	9006510010400
0.0413			1.050	34.00	12.00	9006510010500
0.0421		58	1.070	36.00	14.00	9006510010700
0.0425			1.080	36.00	14.00	9006510010800
0.0429		57	1.090	36.00	14.00	9006510010900
0.0433			1.100	36.00	14.00	9006510011000
0.0437			1.110	36.00	14.00	9006510011100
0.0441			1.120	36.00	14.00	9006510011200
0.0445			1.130	36.00	14.00	9006510011300
0.0449			1.140	36.00	14.00	9006510011400
0.0453			1.150	36.00	14.00	9006510011500
0.0457			1.160	36.00	14.00	9006510011600
0.0461			1.170	36.00	14.00	9006510011700
0.0465		56	1.180	36.00	14.00	9006510011800
0.0469	3/64		1.190	38.00	16.00	9006510011900
0.0472			1.200	38.00	16.00	9006510012000
0.0476			1.210	38.00	16.00	9006510012100
0.0480			1.220	38.00	16.00	9006510012200
0.0488			1.240	38.00	16.00	9006510012400
0.0492			1.250	38.00	16.00	9006510012500
0.0496			1.260	38.00	16.00	9006510012600
0.0500			1.270	38.00	16.00	9006510012700
0.0504			1.280	38.00	16.00	9006510012800
0.0512			1.300	38.00	16.00	9006510013000
0.0516			1.310	38.00	16.00	9006510013100
0.0520		55	1.320	38.00	16.00	9006510013200
0.0528			1.340	40.00	18.00	9006510013400
0.0531			1.350	40.00	18.00	9006510013500
0.0551		54	1.400	40.00	18.00	9006510014000
0.0559			1.420	40.00	18.00	9006510014200
0.0563			1.430	40.00	18.00	9006510014300
0.0571			1.450	40.00	18.00	9006510014500
0.0575			1.460	40.00	18.00	9006510014600
0.0579			1.470	40.00	18.00	9006510014700
0.0583			1.480	40.00	18.00	9006510014800
0.0591			1.500	40.00	18.00	9006510015000
0.0594		53	1.510	43.00	20.00	9006510015100
0.0598			1.520	43.00	20.00	9006510015200
0.0602			1.530	43.00	20.00	9006510015300
0.0606			1.540	43.00	20.00	9006510015400

Series 651

Speeds & Feeds information pg 446

Twist Drills

Dec. inch	Diameter (d1)			I1 mm	I2 mm	EDP #
	Fract. inch	Wire / letter	mm			
0.2209		2	5.610	93.00	57.00	9006510056100
0.2224			5.650	93.00	57.00	9006510056500
0.2244			5.700	93.00	57.00	9006510057000
0.2264			5.750	93.00	57.00	9006510057500
0.2280		1	5.790	93.00	57.00	9006510057900
0.2283			5.800	93.00	57.00	9006510058000
0.2323			5.900	93.00	57.00	9006510059000
0.2339		A	5.940	93.00	57.00	9006510059400
0.2343	15/64		5.950	93.00	57.00	9006510059500
0.2362			6.000	93.00	57.00	9006510060000
0.2378		B	6.040	101.00	63.00	9006510060400
0.2382			6.050	101.00	63.00	9006510060500
0.2402			6.100	101.00	63.00	9006510061000
0.2421		C	6.150	101.00	63.00	9006510061500
0.2441			6.200	101.00	63.00	9006510062000
0.2461		D	6.250	101.00	63.00	9006510062500
0.2480			6.300	101.00	63.00	9006510063000
0.2500	1/4	E	6.350	101.00	63.00	9006510063500
0.2520			6.400	101.00	63.00	9006510064000
0.2559			6.500	101.00	63.00	9006510065000
0.2571		F	6.530	101.00	63.00	9006510065300
0.2598			6.600	101.00	63.00	9006510066000
0.2610		G	6.630	101.00	63.00	9006510066300
0.2638			6.700	101.00	63.00	9006510067000
0.2657	17/64	H	6.750	109.00	69.00	9006510067500
0.2677			6.800	109.00	69.00	9006510068000
0.2697			6.850	109.00	69.00	9006510068500
0.2717		I	6.900	109.00	69.00	9006510069000
0.2756			7.000	109.00	69.00	9006510070000
0.2768		J	7.030	109.00	69.00	9006510070300
0.2795			7.100	109.00	69.00	9006510071000
0.2811	9/32	K	7.140	109.00	69.00	9006510071400
0.2835			7.200	109.00	69.00	9006510072000
0.2854			7.250	109.00	69.00	9006510072500
0.2874			7.300	109.00	69.00	9006510073000
0.2902		L	7.370	109.00	69.00	9006510073700
0.2913			7.400	109.00	69.00	9006510074000
0.2933			7.450	109.00	69.00	9006510074500
0.2949		M	7.490	109.00	69.00	9006510074900
0.2953			7.500	109.00	69.00	9006510075000
0.2969	19/64		7.540	117.00	75.00	9006510075400
0.2992			7.600	117.00	75.00	9006510076000
0.3020		N	7.670	117.00	75.00	9006510076700
0.3031			7.700	117.00	75.00	9006510077000
0.3051			7.750	117.00	75.00	9006510077500
0.3071			7.800	117.00	75.00	9006510078000
0.3110			7.900	117.00	75.00	9006510079000
0.3126	5/16		7.940	117.00	75.00	9006510079400
0.3150			8.000	117.00	75.00	9006510080000
0.3161		O	8.030	117.00	75.00	9006510080300
0.3189			8.100	117.00	75.00	9006510081000
0.3228		P	8.200	117.00	75.00	9006510082000
0.3248			8.250	117.00	75.00	9006510082500
0.3268			8.300	117.00	75.00	9006510083000
0.3280	21/64		8.330	117.00	75.00	9006510083300
0.3307			8.400	117.00	75.00	9006510084000
0.3319		Q	8.430	117.00	75.00	9006510084300
0.3346			8.500	117.00	75.00	9006510085000
0.3386			8.600	125.00	81.00	9006510086000
0.3390		R	8.610	125.00	81.00	9006510086100
0.3425			8.700	125.00	81.00	9006510087000
0.3437	11/32		8.730	125.00	81.00	9006510087300
0.3445			8.750	125.00	81.00	9006510087500
0.3465			8.800	125.00	81.00	9006510088000
0.3480		S	8.840	125.00	81.00	9006510088400
0.3484			8.850	125.00	81.00	9006510088500
0.3504			8.900	125.00	81.00	9006510089000
0.3543			9.000	125.00	81.00	9006510090000
0.3579		T	9.090	125.00	81.00	9006510090900
0.3583			9.100	125.00	81.00	9006510091000
0.3594	23/64		9.130	125.00	81.00	9006510091300

Dec. inch	Diameter (d1)			I1 mm	I2 mm	EDP #
	Fract. inch	Wire / letter	mm			
0.3622			9.200	125.00	81.00	9006510092000
0.3642			9.250	125.00	81.00	9006510092500
0.3661			9.300	125.00	81.00	9006510093000
0.3677		U	9.340	125.00	81.00	9006510093400
0.3701			9.400	125.00	81.00	9006510094000
0.3740			9.500	125.00	81.00	9006510095000
0.3748	3/8		9.520	133.00	87.00	9006510095200
0.3760			9.550	133.00	87.00	9006510095500
0.3772		V	9.580	133.00	87.00	9006510095800
0.3780			9.600	133.00	87.00	9006510096000
0.3819			9.700	133.00	87.00	9006510097000
0.3839			9.750	133.00	87.00	9006510097500
0.3858		W	9.800	133.00	87.00	9006510098000
0.3898			9.900	133.00	87.00	9006510099000
0.3906	25/64		9.920	133.00	87.00	9006510099200
0.3937			10.000	133.00	87.00	9006510100000
0.3961			10.060	133.00	87.00	9006510100600
0.3969		X	10.080	133.00	87.00	9006510100800
0.3976			10.100	133.00	87.00	9006510101000
0.4016			10.200	133.00	87.00	9006510102000
0.4035			10.250	133.00	87.00	9006510102500
0.4039		Y	10.260	133.00	87.00	9006510102600
0.4055			10.300	133.00	87.00	9006510103000
0.4063	13/32		10.320	133.00	87.00	9006510103200
0.4094			10.400	133.00	87.00	9006510104000
0.4130		Z	10.490	133.00	87.00	9006510104900
0.4134			10.500	133.00	87.00	9006510105000
0.4154			10.550	133.00	87.00	9006510105500
0.4173			10.600	133.00	87.00	9006510106000
0.4213			10.700	142.00	94.00	9006510107000
0.4220	27/64		10.720	142.00	94.00	9006510107200
0.4232			10.750	142.00	94.00	9006510107500
0.4252			10.800	142.00	94.00	9006510108000
0.4291			10.900	142.00	94.00	9006510109000
0.4331			11.000	142.00	94.00	9006510110000
0.4370			11.100	142.00	94.00	9006510111000
0.4374	7/16		11.110	142.00	94.00	9006510111100
0.4409			11.200	142.00	94.00	9006510112000
0.4429			11.250	142.00	94.00	9006510112500
0.4449			11.300	142.00	94.00	9006510113000
0.4488			11.400	142.00	94.00	9006510114000
0.4528			11.500	142.00	94.00	9006510115000
0.4531	29/64		11.510	142.00	94.00	9006510115100
0.4587			11.650	142.00	94.00	9006510116500
0.4606			11.700	142.00	94.00	9006510117000
0.4646			11.800	142.00	94.00	9006510118000
0.4689	15/32		11.910	151.00	101.00	9006510119100
0.4724			12.000	151.00	101.00	9006510120000
0.4764			12.100	151.00	101.00	9006510121000
0.4803			12.200	151.00	101.00	9006510122000
0.4843	31/64		12.300	151.00	101.00	9006510123000
0.4882			12.400	151.00	101.00	9006510124000
0.4921			12.500	151.00	101.00	9006510125000
0.4961			12.600	151.00	101.00	9006510126000
0.5000	1/2		12.700	151.00	101.00	9006510127000
0.5039			12.800	151.00	101.00	9006510128000
0.5079			12.900	151.00	101.00	9006510129000
0.5118			13.000	151.00	101.00	9006510130000
0.5157	33/64		13.100	151.00	101.00	9006510131000
0.5197			13.200	151.00	101.00	9006510132000
0.5217			13.250	160.00	108.00	9006510132500
0.5311	17/32		13.490	160.00	108.00	9006510134900
0.5315			13.500	160.00	108.00	9006510135000
0.5394			13.700	160.00	108.00	9006510137000
0.5433			13.800	160.00	108.00	9006510138000
0.5469	35/64		13.890	160.00	108.00	9006510138900
0.5472			13.900	160.00	108.00	9006510139000
0.5512			14.000	160.00	108.00	9006510140000
0.5591			14.200	169.00	114.00	9006510142000
0.5610			14.250	169.00	114.00	9006510142500
0.5626	9/16		14.290	169.00	114.00	9006510142900

Series 651

Speeds & Feeds information pg 446

Twist Drills

Dec. inch	Diameter (d1)		l1 mm	l2 mm	EDP #	
	Fract. inch	Wire / letter				
0.5709			14.500	169.00	114.00	9006510145000
0.5748			14.600	169.00	114.00	9006510146000
0.5780	37/64		14.680	169.00	114.00	9006510146800
0.5807			14.750	169.00	114.00	9006510147500
0.5827			14.800	169.00	114.00	9006510148000
0.5906			15.000	169.00	114.00	9006510150000
0.5937	19/32		15.080	178.00	120.00	9006510150800
0.6004			15.250	178.00	120.00	9006510152500
0.6094	39/64		15.480	178.00	120.00	9006510154800
0.6102			15.500	178.00	120.00	9006510155000
0.6201			15.750	178.00	120.00	9006510157500
0.6220			15.800	178.00	120.00	9006510158000
0.6248	5/8		15.870	178.00	120.00	9006510158700
0.6299			16.000	178.00	120.00	9006510160000

Dec. inch	Diameter (d1)		l1 mm	l2 mm	EDP #	
	Fract. inch	Wire / letter				
0.6594			16.750	184.00	125.00	9006510167500
0.6693			17.000	184.00	125.00	9006510170000
0.6890			17.500	191.00	130.00	9006510175000
0.7087			18.000	191.00	130.00	9006510180000
0.7283			18.500	198.00	135.00	9006510185000
0.7480			19.000	198.00	135.00	9006510190000

Alternative Drill Series:

- #205 HSS, GT100, 5xD, 118 pt, Bright/Steam Oxide > 2.36
- #5519, Cobalt, GU 500, 5xD, 130 pt., TIN
- #305 Cobalt, GP, 5xD, 118 pt, Bright/Steam Oxide > 2.36
- #530 PM Cobalt, GT500, 5xD, 130 pt, FIREX®

*Items listed in red are non-stocked items, and may take 2 - 6 weeks to receive

5xD

TiN coated



External Coolant

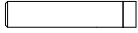

Straight Shank

Speeds & Feeds
information pg 447**Series 652****GT 100 Parabolic**HSS, GT 100, jobber length, 130° point, Form A web thinned all dia.,
standard straight shank, RH helix

Cut / Shank Dia. = h8 tolerance range

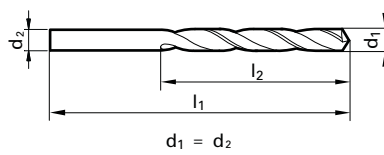

Application Materials:



General Steels



Aluminum & Alloys



Universal Steels

Dec. inch	Diameter (d1)		l1 mm	l2 mm	EDP #
	Fract. inch	Wire / letter			
0.0394			34.00	12.00	9006520010000
0.0402		60	34.00	12.00	9006520010200
0.0409		59	34.00	12.00	9006520010400
0.0421		58	36.00	14.00	9006520010700
0.0429		57	36.00	14.00	9006520010900
0.0433			36.00	14.00	9006520011000
0.0465		56	36.00	14.00	9006520011800
0.0469	3/64		38.00	16.00	9006520011900
0.0472			38.00	16.00	9006520012000
0.0480			38.00	16.00	9006520012200
0.0492			38.00	16.00	9006520012500
0.0512			38.00	16.00	9006520013000
0.0520		55	38.00	16.00	9006520013200
0.0531			40.00	18.00	9006520013500
0.0551		54	40.00	18.00	9006520014000
0.0571			40.00	18.00	9006520014500
0.0591			40.00	18.00	9006520015000
0.0594		53	43.00	20.00	9006520015100
0.0602			43.00	20.00	9006520015300
0.0610			43.00	20.00	9006520015500
0.0626	1/16		43.00	20.00	9006520015900
0.0630			43.00	20.00	9006520016000
0.0634		52	43.00	20.00	9006520016100
0.0650			43.00	20.00	9006520016500
0.0669		51	43.00	20.00	9006520017000
0.0677			46.00	22.00	9006520017200
0.0689			46.00	22.00	9006520017500
0.0701		50	46.00	22.00	9006520017800
0.0709			46.00	22.00	9006520018000
0.0728		49	46.00	22.00	9006520018500
0.0748			46.00	22.00	9006520019000
0.0760		48	49.00	24.00	9006520019300
0.0768			49.00	24.00	9006520019500
0.0780	5/64		49.00	24.00	9006520019800
0.0783		47	49.00	24.00	9006520019900
0.0787			49.00	24.00	9006520020000
0.0811		46	49.00	24.00	9006520020600
0.0819		45	49.00	24.00	9006520020800
0.0827			49.00	24.00	9006520021000
0.0846			53.00	27.00	9006520021500
0.0858		44	53.00	27.00	9006520021800
0.0866			53.00	27.00	9006520022000
0.0890		43	53.00	27.00	9006520022600
0.0906			53.00	27.00	9006520023000
0.0925			53.00	27.00	9006520023500
0.0933		42	57.00	30.00	9006520023700
0.0937	3/32		57.00	30.00	9006520023800
0.0945			57.00	30.00	9006520024000
0.0961		41	57.00	30.00	9006520024400
0.0965			57.00	30.00	9006520024500
0.0980		40	57.00	30.00	9006520024900
0.0984			57.00	30.00	9006520025000
0.0996		39	57.00	30.00	9006520025300
0.1004			57.00	30.00	9006520025500

Dec. inch	Diameter (d1)		l1 mm	l2 mm	EDP #
	Fract. inch	Wire / letter			
0.1016		38	57.00	30.00	9006520025800
0.1024			57.00	30.00	9006520026000
0.1039		37	57.00	30.00	9006520026400
0.1043			57.00	30.00	9006520026500
0.1063			61.00	33.00	9006520027000
0.1067		36	61.00	33.00	9006520027100
0.1083			61.00	33.00	9006520027500
0.1094	7/64		61.00	33.00	9006520027800
0.1098		35	61.00	33.00	9006520027900
0.1102			61.00	33.00	9006520028000
0.1110		34	61.00	33.00	9006520028200
0.1122			61.00	33.00	9006520028500
0.1130		33	61.00	33.00	9006520028700
0.1142			61.00	33.00	9006520029000
0.1161		32	61.00	33.00	9006520029500
0.1181			61.00	33.00	9006520030000
0.1201		31	65.00	36.00	9006520030500
0.1220			65.00	36.00	9006520031000
0.1248	1/8		65.00	36.00	9006520031700
0.1260			65.00	36.00	9006520032000
0.1280			65.00	36.00	9006520032500
0.1283		30	65.00	36.00	9006520032600
0.1299			65.00	36.00	9006520033000
0.1339			70.00	39.00	9006520034000
0.1358		29	70.00	39.00	9006520034500
0.1378			70.00	39.00	9006520035000
0.1406	9/64	28	70.00	39.00	9006520035700
0.1417			70.00	39.00	9006520036000
0.1441		27	70.00	39.00	9006520036600
0.1457			70.00	39.00	9006520037000
0.1469		26	70.00	39.00	9006520037300
0.1476			70.00	39.00	9006520037500
0.1496		25	75.00	43.00	9006520038000
0.1520		24	75.00	43.00	9006520038600
0.1535			75.00	43.00	9006520039000
0.1539		23	75.00	43.00	9006520039100
0.1563	5/32		75.00	43.00	9006520039700
0.1571		22	75.00	43.00	9006520039900
0.1575			75.00	43.00	9006520040000
0.1591		21	75.00	43.00	9006520040400
0.1594			75.00	43.00	9006520040500
0.1610		20	75.00	43.00	9006520040900
0.1614			75.00	43.00	9006520041000
0.1654			75.00	43.00	9006520042000
0.1661		19	75.00	43.00	9006520042200
0.1673			75.00	43.00	9006520042500
0.1693		18	80.00	47.00	9006520043000
0.1720	11/64		80.00	47.00	9006520043700
0.1728		17	80.00	47.00	9006520043900
0.1732			80.00	47.00	9006520044000
0.1752			80.00	47.00	9006520044500
0.1772		16	80.00	47.00	9006520045000
0.1799		15	80.00	47.00	9006520045700
0.1811			80.00	47.00	9006520046000

3xD



TiN coated



External Coolant



Straight Shank

Speeds & Feeds
information pg 447

Series 653

General Purpose

HSS, general purpose (Type N), stub length, 118° point, Form A web thinned >2.36mm dia., standard straight shank, RH helix

Cut / Shank Dia. = h8 tolerance range

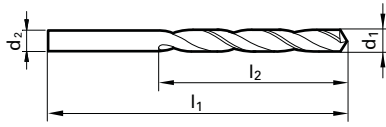

$$d_1 = d_2$$

Application Materials:

- Universal Steels
- Cast Iron
- General Steels

Dec. inch	Fract. inch	Wire / letter	Diameter (d1) mm	l1 mm	l2 mm	EDP #
0.0197			0.500	20.00	3.00	9006530005000
0.0236			0.600	21.00	3.50	9006530006000
0.0276			0.700	23.00	4.50	9006530007000
0.0295			0.750	23.00	4.50	9006530007500
0.0315			0.800	24.00	5.00	9006530008000
0.0354			0.900	25.00	5.50	9006530009000
0.0394			1.000	26.00	6.00	9006530010000
0.0402		60	1.020	26.00	6.00	9006530010200
0.0413			1.050	26.00	6.00	9006530010500
0.0421		58	1.070	28.00	7.00	9006530010700
0.0429		57	1.090	28.00	7.00	9006530010900
0.0433			1.100	28.00	7.00	9006530011000
0.0437			1.110	28.00	7.00	9006530011100
0.0453			1.150	28.00	7.00	9006530011500
0.0465		56	1.180	28.00	7.00	9006530011800
0.0469	3/64		1.190	28.00	7.00	9006530011900
0.0472			1.200	28.00	7.00	9006530012000
0.0492			1.250	28.00	7.00	9006530012500
0.0504			1.280	28.00	7.00	9006530012800
0.0512			1.300	28.00	7.00	9006530013000
0.0520		55	1.320	28.00	7.00	9006530013200
0.0531			1.350	32.00	9.00	9006530013500
0.0551		54	1.400	32.00	9.00	9006530014000
0.0571			1.450	32.00	9.00	9006530014500
0.0591			1.500	32.00	9.00	9006530015000
0.0594		53	1.510	34.00	10.00	9006530015100
0.0610			1.550	34.00	10.00	9006530015500
0.0626	1/16		1.590	34.00	10.00	9006530015900
0.0630			1.600	34.00	10.00	9006530016000
0.0634		52	1.610	34.00	10.00	9006530016100
0.0650			1.650	34.00	10.00	9006530016500
0.0669		51	1.700	34.00	10.00	9006530017000
0.0701		50	1.780	36.00	11.00	9006530017800
0.0709			1.800	36.00	11.00	9006530018000
0.0728		49	1.850	36.00	11.00	9006530018500
0.0748			1.900	36.00	11.00	9006530019000
0.0760		48	1.930	38.00	12.00	9006530019300
0.0768			1.950	38.00	12.00	9006530019500
0.0780	5/64		1.980	38.00	12.00	9006530019800
0.0783		47	1.990	38.00	12.00	9006530019900
0.0787			2.000	38.00	12.00	9006530020000
0.0811		46	2.060	38.00	12.00	9006530020600
0.0819		45	2.080	38.00	12.00	9006530020800
0.0827			2.100	38.00	12.00	9006530021000
0.0858		44	2.180	40.00	13.00	9006530021800
0.0866			2.200	40.00	13.00	9006530022000
0.0886			2.250	40.00	13.00	9006530022500
0.0890		43	2.260	40.00	13.00	9006530022600
0.0906			2.300	40.00	13.00	9006530023000
0.0925			2.350	40.00	13.00	9006530023500
0.0933		42	2.370	43.00	14.00	9006530023700
0.0937	3/32		2.380	43.00	14.00	9006530023800
0.0945			2.400	43.00	14.00	9006530024000
0.0961		41	2.440	43.00	14.00	9006530024400

Dec. inch	Fract. inch	Wire / letter	Diameter (d1) mm	l1 mm	l2 mm	EDP #
0.0965			2.450	43.00	14.00	9006530024500
0.0984			2.500	43.00	14.00	9006530025000
0.0996		39	2.530	43.00	14.00	9006530025300
0.1004			2.550	43.00	14.00	9006530025500
0.1016		38	2.580	43.00	14.00	9006530025800
0.1024			2.600	43.00	14.00	9006530026000
0.1039		37	2.640	43.00	14.00	9006530026400
0.1063			2.700	46.00	16.00	9006530027000
0.1067		36	2.710	46.00	16.00	9006530027100
0.1083			2.750	46.00	16.00	9006530027500
0.1094	7/64		2.780	46.00	16.00	9006530027800
0.1102			2.800	46.00	16.00	9006530028000
0.1130		33	2.870	46.00	16.00	9006530028700
0.1142			2.900	46.00	16.00	9006530029000
0.1161		32	2.950	46.00	16.00	9006530029500
0.1181			3.000	46.00	16.00	9006530030000
0.1201		31	3.050	49.00	18.00	9006530030500
0.1220			3.100	49.00	18.00	9006530031000
0.1248	1/8		3.170	49.00	18.00	9006530031700
0.1260			3.200	49.00	18.00	9006530032000
0.1280			3.250	49.00	18.00	9006530032500
0.1283		30	3.260	49.00	18.00	9006530032600
0.1299			3.300	49.00	18.00	9006530033000
0.1339			3.400	52.00	20.00	9006530034000
0.1358		29	3.450	52.00	20.00	9006530034500
0.1378			3.500	52.00	20.00	9006530035000
0.1406	9/64	28	3.570	52.00	20.00	9006530035700
0.1417			3.600	52.00	20.00	9006530036000
0.1437			3.650	52.00	20.00	9006530036500
0.1441		27	3.660	52.00	20.00	9006530036600
0.1457			3.700	52.00	20.00	9006530037000
0.1469		26	3.730	52.00	20.00	9006530037300
0.1476			3.750	52.00	20.00	9006530037500
0.1496		25	3.800	55.00	22.00	9006530038000
0.1535			3.900	55.00	22.00	9006530039000
0.1563	5/32		3.970	55.00	22.00	9006530039700
0.1571		22	3.990	55.00	22.00	9006530039900
0.1575			4.000	55.00	22.00	9006530040000
0.1591		21	4.040	55.00	22.00	9006530040400
0.1610		20	4.090	55.00	22.00	9006530040900
0.1614			4.100	55.00	22.00	9006530041000
0.1634			4.150	55.00	22.00	9006530041500
0.1654			4.200	55.00	22.00	9006530042000
0.1673			4.250	55.00	22.00	9006530042500
0.1693		18	4.300	58.00	24.00	9006530043000
0.1720	11/64		4.370	58.00	24.00	9006530043700
0.1732			4.400	58.00	24.00	9006530044000
0.1772		16	4.500	58.00	24.00	9006530045000
0.1799		15	4.570	58.00	24.00	9006530045700
0.1811			4.600	58.00	24.00	9006530046000
0.1819		14	4.620	58.00	24.00	9006530046200
0.1831			4.650	58.00	24.00	9006530046500
0.1850		13	4.700	58.00	24.00	9006530047000
0.1874	3/16		4.760	62.00	26.00	9006530047600

Series 653

Speeds & Feeds information pg 447

Twist Drills

Dec. inch	Diameter (d1)		I1 mm	I2 mm	EDP #	
	Fract. inch	Wire / letter				
0.6693			17.000	119.00	60.00	9006530170000
0.6874	11/16		17.460	123.00	62.00	9006530174600
0.6890			17.500	123.00	62.00	9006530175000
0.7031	45/64		17.860	123.00	62.00	9006530178600
0.7087			18.000	123.00	62.00	9006530180000
0.7185			18.250	127.00	64.00	9006530182500
0.7189	23/32		18.260	127.00	64.00	9006530182600
0.7283			18.500	127.00	64.00	9006530185000
0.7343	47/64		18.650	127.00	64.00	9006530186500
0.7480			19.000	127.00	64.00	9006530190000
0.7500	3/4		19.050	131.00	66.00	9006530190500
0.7677			19.500	131.00	66.00	9006530195000
0.7874			20.000	131.00	66.00	9006530200000
0.8071			20.500	136.00	68.00	9006530205000
0.8126	13/16		20.640	136.00	68.00	9006530206400
0.8268			21.000	136.00	68.00	9006530210000
0.8465			21.500	141.00	70.00	9006530215000
0.8661			22.000	141.00	70.00	9006530220000

Dec. inch	Diameter (d1)		I1 mm	I2 mm	EDP #	
	Fract. inch	Wire / letter				
0.8858			22.500	146.00	72.00	9006530225000
0.8906	57/64		22.620	146.00	72.00	9006530226200
0.9055			23.000	146.00	72.00	9006530230000
0.9220	59/64		23.420	146.00	72.00	9006530234200
0.9449			24.000	151.00	75.00	9006530240000
0.9646			24.500	151.00	75.00	9006530245000
0.9843	63/64		25.000	151.00	75.00	9006530250000
1.0000	1		25.400	156.00	78.00	9006530254000
1.1220			28.500	168.00	84.00	9006530285000

Alternative Drill Series:
#5524 Cobalt, GU500, 3xD, 118 pt, Bright
#223 HSS, GP, 3xD, 118 pt, Bright/Steam Oxide > 2.36
#730 Carbide, GP, 3xD, 118 pt, Bright
#2463 Carbide, GP, 3xD, 118 pt, FIREX®

Series 654

Speeds & Feeds information pg 448

Twist Drills

Dec. inch	Diameter (d1)		Shank size	l1 mm	l2 mm	EDP #
	Fract. inch	Wire / letter				
1.0000	1		MTS 3	286.00	165.00	9006540254000
1.0039			MTS 3	286.00	165.00	9006540255000
1.0236			MTS 3	286.00	165.00	9006540260000
1.0433			MTS 3	286.00	165.00	9006540265000
1.0626	1 1/16		MTS 3	291.00	170.00	9006540269900
1.0630			MTS 3	291.00	170.00	9006540270000
1.1024			MTS 3	291.00	170.00	9006540280000
1.1220			MTS 3	296.00	175.00	9006540285000
1.1248	1 1/8		MTS 3	296.00	175.00	9006540285700

Dec. inch	Diameter (d1)		Shank size	l1 mm	l2 mm	EDP #
	Fract. inch	Wire / letter				
1.1417			MTS 3	296.00	175.00	9006540290000
1.1614			MTS 3	296.00	175.00	9006540295000
1.1713			MTS 3	296.00	175.00	9006540297500
1.2008			MTS 3	301.00	180.00	9006540305000

Alternative Drill Series:

- #345 Cobalt, GP, 5xD, 118 pt, Oxide
- #661 Cobalt, GP, 5xD, 118 pt, TiN

5xD



TiN Coated



External Coolant

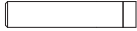

Straight Shank

Speeds & Feeds
information pg 448

Series 657

Type Ti

Cobalt, Type Ti, jobber length, self-centering 130° split point, web thinned >1.0mm dia., standard straight shank, RH helix

Cut / Shank Dia. = h8 tolerance range

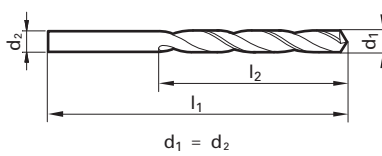

Application Materials:

- Universal Steels
- Stainless Steels
- Hardened Materials
- Ti & Ni Alloys

Twist Drills

Diameter (d1)		l1		l2		EDP #
Dec. inch	Fract. inch	mm	mm	mm	mm	
0.0197		0.500	22.00	6.00	9006570005000	
0.0209		0.530	22.00	6.00	9006570005300	
0.0236		0.600	24.00	7.00	9006570006000	
0.0256		0.650	26.00	8.00	9006570006500	
0.0276		0.700	28.00	9.00	9006570007000	
0.0295		0.750	28.00	9.00	9006570007500	
0.0315		0.800	30.00	10.00	9006570008000	
0.0335		0.850	30.00	10.00	9006570008500	
0.0346		0.880	32.00	11.00	9006570008800	
0.0354		0.900	32.00	11.00	9006570009000	
0.0362		0.920	32.00	11.00	9006570009200	
0.0370		0.940	32.00	11.00	9006570009400	
0.0374		0.950	32.00	11.00	9006570009500	
0.0394		1.000	34.00	12.00	9006570010000	
0.0409		1.040	34.00	12.00	9006570010400	
0.0413		1.050	34.00	12.00	9006570010500	
0.0433		1.100	36.00	14.00	9006570011000	
0.0453		1.150	36.00	14.00	9006570011500	
0.0465		1.180	36.00	14.00	9006570011800	
0.0469	3/64	1.190	38.00	16.00	9006570011900	
0.0472		1.200	38.00	16.00	9006570012000	
0.0476		1.210	38.00	16.00	9006570012100	
0.0492		1.250	38.00	16.00	9006570012500	
0.0512		1.300	38.00	16.00	9006570013000	
0.0520		1.320	38.00	16.00	9006570013200	
0.0531		1.350	40.00	18.00	9006570013500	
0.0547		1.390	40.00	18.00	9006570013900	
0.0551		1.400	40.00	18.00	9006570014000	
0.0571		1.450	40.00	18.00	9006570014500	
0.0591		1.500	40.00	18.00	9006570015000	
0.0594		1.510	43.00	20.00	9006570015100	
0.0610		1.550	43.00	20.00	9006570015500	
0.0626	1/16	1.590	43.00	20.00	9006570015900	
0.0630		1.600	43.00	20.00	9006570016000	
0.0634		1.610	43.00	20.00	9006570016100	
0.0650		1.650	43.00	20.00	9006570016500	
0.0669		1.700	43.00	20.00	9006570017000	
0.0689		1.750	46.00	22.00	9006570017500	
0.0701		1.780	46.00	22.00	9006570017800	
0.0709		1.800	46.00	22.00	9006570018000	
0.0728		1.850	46.00	22.00	9006570018500	
0.0748		1.900	46.00	22.00	9006570019000	
0.0768		1.950	49.00	24.00	9006570019500	
0.0780	5/64	1.980	49.00	24.00	9006570019800	
0.0787		2.000	49.00	24.00	9006570020000	
0.0807		2.050	49.00	24.00	9006570020500	
0.0827		2.100	49.00	24.00	9006570021000	
0.0846		2.150	53.00	27.00	9006570021500	
0.0866		2.200	53.00	27.00	9006570022000	
0.0890		2.260	53.00	27.00	9006570022600	
0.0906		2.300	53.00	27.00	9006570023000	
0.0925		2.350	53.00	27.00	9006570023500	
0.0937	3/32	2.380	57.00	30.00	9006570023800	
0.0945		2.400	57.00	30.00	9006570024000	
0.0961		2.440	57.00	30.00	9006570024400	

Diameter (d1)		l1		l2		EDP #
Dec. inch	Fract. inch	mm	mm	mm	mm	
0.0984		2.500	57.00	30.00	9006570025000	
0.0996		2.530	57.00	30.00	9006570025300	
0.1004		2.550	57.00	30.00	9006570025500	
0.1024		2.600	57.00	30.00	9006570026000	
0.1063		2.700	61.00	33.00	9006570027000	
0.1094	7/64	2.780	61.00	33.00	9006570027800	
0.1102		2.800	61.00	33.00	9006570028000	
0.1110		2.820	61.00	33.00	9006570028200	
0.1142		2.900	61.00	33.00	9006570029000	
0.1161		2.950	61.00	33.00	9006570029500	
0.1181		3.000	61.00	33.00	9006570030000	
0.1201		3.050	65.00	36.00	9006570030500	
0.1220		3.100	65.00	36.00	9006570031000	
0.1248	1/8	3.170	65.00	36.00	9006570031700	
0.1260		3.200	65.00	36.00	9006570032000	
0.1283		3.260	65.00	36.00	9006570032600	
0.1299		3.300	65.00	36.00	9006570033000	
0.1339		3.400	70.00	39.00	9006570034000	
0.1378		3.500	70.00	39.00	9006570035000	
0.1406	9/64	3.570	70.00	39.00	9006570035700	
0.1417		3.600	70.00	39.00	9006570036000	
0.1457		3.700	70.00	39.00	9006570037000	
0.1496		3.800	75.00	43.00	9006570038000	
0.1535		3.900	75.00	43.00	9006570039000	
0.1563	5/32	3.970	75.00	43.00	9006570039700	
0.1575		4.000	75.00	43.00	9006570040000	
0.1614		4.100	75.00	43.00	9006570041000	
0.1654		4.200	75.00	43.00	9006570042000	
0.1673		4.250	75.00	43.00	9006570042500	
0.1693		4.300	80.00	47.00	9006570043000	
0.1713		4.350	80.00	47.00	9006570043500	
0.1720	11/64	4.370	80.00	47.00	9006570043700	
0.1732		4.400	80.00	47.00	9006570044000	
0.1772		4.500	80.00	47.00	9006570045000	
0.1811		4.600	80.00	47.00	9006570046000	
0.1850		4.700	80.00	47.00	9006570047000	
0.1874	3/16	4.760	86.00	52.00	9006570047600	
0.1890		4.800	86.00	52.00	9006570048000	
0.1929		4.900	86.00	52.00	9006570049000	
0.1969		5.000	86.00	52.00	9006570050000	
0.2008		5.100	86.00	52.00	9006570051000	
0.2012		5.110	86.00	52.00	9006570051100	
0.2031	13/64	5.160	86.00	52.00	9006570051600	
0.2047		5.200	86.00	52.00	9006570052000	
0.2087		5.300	86.00	52.00	9006570053000	
0.2126		5.400	93.00	57.00	9006570054000	
0.2165		5.500	93.00	57.00	9006570055000	
0.2189	7/32	5.560	93.00	57.00	9006570055600	
0.2205		5.600	93.00	57.00	9006570056000	
0.2209		5.610	93.00	57.00	9006570056100	
0.2244		5.700	93.00	57.00	9006570057000	
0.2283		5.800	93.00	57.00	9006570058000	
0.2323		5.900	93.00	57.00	9006570059000	
0.2343	15/64	5.950	93.00	57.00	9006570059500	
0.2362		6.000	93.00	57.00	9006570060000	

*Items listed in red are non-stocked items, and may take 2 - 6 weeks to receive

Series 657

Speeds & Feeds information pg 448

Dec. inch	Diameter (d1)		I1 mm	I2 mm	EDP #	
	Fract. inch	Wire / letter				
0.2402			6.100	101.00	63.00	9006570061000
0.2441			6.200	101.00	63.00	9006570062000
0.2480			6.300	101.00	63.00	9006570063000
0.2500	1/4	E	6.350	101.00	63.00	9006570063500
0.2520			6.400	101.00	63.00	9006570064000
0.2559			6.500	101.00	63.00	9006570065000
0.2598			6.600	101.00	63.00	9006570066000
0.2638			6.700	101.00	63.00	9006570067000
0.2657	17/64	H	6.750	109.00	69.00	9006570067500
0.2677			6.800	109.00	69.00	9006570068000
0.2717		I	6.900	109.00	69.00	9006570069000
0.2756			7.000	109.00	69.00	9006570070000
0.2795			7.100	109.00	69.00	9006570071000
0.2811	9/32	K	7.140	109.00	69.00	9006570071400
0.2835			7.200	109.00	69.00	9006570072000
0.2874			7.300	109.00	69.00	9006570073000
0.2913			7.400	109.00	69.00	9006570074000
0.2953			7.500	109.00	69.00	9006570075000
0.2969	19/64		7.540	117.00	75.00	9006570075400
0.2992			7.600	117.00	75.00	9006570076000
0.3031			7.700	117.00	75.00	9006570077000
0.3071			7.800	117.00	75.00	9006570078000
0.3110			7.900	117.00	75.00	9006570079000
0.3126	5/16		7.940	117.00	75.00	9006570079400
0.3150			8.000	117.00	75.00	9006570080000
0.3189			8.100	117.00	75.00	9006570081000
0.3228		P	8.200	117.00	75.00	9006570082000
0.3268			8.300	117.00	75.00	9006570083000
0.3307			8.400	117.00	75.00	9006570084000
0.3346			8.500	117.00	75.00	9006570085000
0.3366			8.550	125.00	81.00	9006570085500
0.3386			8.600	125.00	81.00	9006570086000
0.3425			8.700	125.00	81.00	9006570087000
0.3437	11/32		8.730	125.00	81.00	9006570087300

Dec. inch	Diameter (d1)		I1 mm	I2 mm	EDP #	
	Fract. inch	Wire / letter				
0.3465			8.800	125.00	81.00	9006570088000
0.3504			8.900	125.00	81.00	9006570089000
0.3543			9.000	125.00	81.00	9006570090000
0.3583			9.100	125.00	81.00	9006570091000
0.3594	23/64		9.130	125.00	81.00	9006570091300
0.3622			9.200	125.00	81.00	9006570092000
0.3701			9.400	125.00	81.00	9006570094000
0.3740			9.500	125.00	81.00	9006570095000
0.3748	3/8		9.520	133.00	87.00	9006570095200
0.3780			9.600	133.00	87.00	9006570096000
0.3819			9.700	133.00	87.00	9006570097000
0.3858		W	9.800	133.00	87.00	9006570098000
0.3906	25/64		9.920	133.00	87.00	9006570099200
0.3937			10.000	133.00	87.00	9006570100000
0.4016			10.200	133.00	87.00	9006570102000
0.4063	13/32		10.320	133.00	87.00	9006570103200
0.4134			10.500	133.00	87.00	9006570105000
0.4252			10.800	142.00	94.00	9006570108000
0.4331			11.000	142.00	94.00	9006570110000
0.4374	7/16		11.110	142.00	94.00	9006570111100
0.4409			11.200	142.00	94.00	9006570112000
0.4528			11.500	142.00	94.00	9006570115000
0.4724			12.000	151.00	101.00	9006570120000
0.4921			12.500	151.00	101.00	9006570125000
0.5000	1/2		12.700	151.00	101.00	9006570127000
0.5118			13.000	151.00	101.00	9006570130000

Alternative Drill Series:

- #605 Cobalt, Ti, 5xD, 130 pt., Bright
- #2458, Cobalt, Ti, 5xD, 130 pt., FIREX®
- #530 PM cobalt, GT500, 5xD, 130 pt., FIREX®

5xD



TiN coated



External Coolant

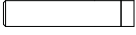

Straight Shank

Speeds & Feeds information pg 449

Series 658

GT 100 Parabolic

Cobalt, GT 100, jobber length, 130° point, Form A web thinned all dia., standard straight shank, RH helix

Cut / Shank Dia. = h8 tolerance range

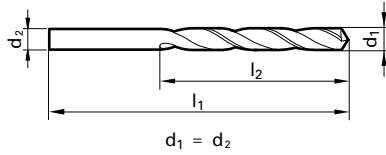

Application Materials:

- General Steels/Brass
- Aluminum & Alloys
- Universal Steels
- Stainless Steels
- Hardened Materials

Twist Drills

Dec. inch	Diameter (d1)			l1 mm	l2 mm	EDP #
	Fract. inch	Wire / letter	mm			
0.0394			1.000	34.00	12.00	9006580010000
0.0402		60	1.020	34.00	12.00	9006580010200
0.0413			1.050	34.00	12.00	9006580010500
0.0421		58	1.070	36.00	14.00	9006580010700
0.0433			1.100	36.00	14.00	9006580011000
0.0445			1.130	36.00	14.00	9006580011300
0.0453			1.150	36.00	14.00	9006580011500
0.0469		3/64	1.190	38.00	16.00	9006580011900
0.0472			1.200	38.00	16.00	9006580012000
0.0512			1.300	38.00	16.00	9006580013000
0.0520		55	1.320	38.00	16.00	9006580013200
0.0531			1.350	40.00	18.00	9006580013500
0.0551		54	1.400	40.00	18.00	9006580014000
0.0571			1.450	40.00	18.00	9006580014500
0.0591			1.500	40.00	18.00	9006580015000
0.0610			1.550	43.00	20.00	9006580015500
0.0626		1/16	1.590	43.00	20.00	9006580015900
0.0630			1.600	43.00	20.00	9006580016000
0.0634		52	1.610	43.00	20.00	9006580016100
0.0642			1.630	43.00	20.00	9006580016300
0.0650			1.650	43.00	20.00	9006580016500
0.0669		51	1.700	43.00	20.00	9006580017000
0.0701		50	1.780	46.00	22.00	9006580017800
0.0709			1.800	46.00	22.00	9006580018000
0.0728		49	1.850	46.00	22.00	9006580018500
0.0748			1.900	46.00	22.00	9006580019000
0.0760		48	1.930	49.00	24.00	9006580019300
0.0768			1.950	49.00	24.00	9006580019500
0.0780		5/64	1.980	49.00	24.00	9006580019800
0.0783		47	1.990	49.00	24.00	9006580019900
0.0787			2.000	49.00	24.00	9006580020000
0.0807			2.050	49.00	24.00	9006580020500
0.0811		46	2.060	49.00	24.00	9006580020600
0.0819		45	2.080	49.00	24.00	9006580020800
0.0827			2.100	49.00	24.00	9006580021000
0.0846			2.150	53.00	27.00	9006580021500
0.0858		44	2.180	53.00	27.00	9006580021800
0.0866			2.200	53.00	27.00	9006580022000
0.0890		43	2.260	53.00	27.00	9006580022600
0.0906			2.300	53.00	27.00	9006580023000
0.0925			2.350	53.00	27.00	9006580023500
0.0933		42	2.370	57.00	30.00	9006580023700
0.0937		3/32	2.380	57.00	30.00	9006580023800
0.0945			2.400	57.00	30.00	9006580024000
0.0961		41	2.440	57.00	30.00	9006580024400
0.0965			2.450	57.00	30.00	9006580024500
0.0980		40	2.490	57.00	30.00	9006580024900
0.0984			2.500	57.00	30.00	9006580025000
0.0996		39	2.530	57.00	30.00	9006580025300
0.1004			2.550	57.00	30.00	9006580025500
0.1016		38	2.580	57.00	30.00	9006580025800
0.1024			2.600	57.00	30.00	9006580026000
0.1039		37	2.640	57.00	30.00	9006580026400
0.1043			2.650	57.00	30.00	9006580026500

Dec. inch	Diameter (d1)			l1 mm	l2 mm	EDP #
	Fract. inch	Wire / letter	mm			
0.1063			2.700	61.00	33.00	9006580027000
0.1094		7/64	2.780	61.00	33.00	9006580027800
0.1098			2.790	61.00	33.00	9006580027900
0.1102			2.800	61.00	33.00	9006580028000
0.1110		34	2.820	61.00	33.00	9006580028200
0.1130		33	2.870	61.00	33.00	9006580028700
0.1142			2.900	61.00	33.00	9006580029000
0.1161		32	2.950	61.00	33.00	9006580029500
0.1181			3.000	61.00	33.00	9006580030000
0.1201		31	3.050	65.00	36.00	9006580030500
0.1220			3.100	65.00	36.00	9006580031000
0.1248		1/8	3.170	65.00	36.00	9006580031700
0.1260			3.200	65.00	36.00	9006580032000
0.1280			3.250	65.00	36.00	9006580032500
0.1283		30	3.260	65.00	36.00	9006580032600
0.1299			3.300	65.00	36.00	9006580033000
0.1339			3.400	70.00	39.00	9006580034000
0.1358		29	3.450	70.00	39.00	9006580034500
0.1378			3.500	70.00	39.00	9006580035000
0.1406		9/64	3.570	70.00	39.00	9006580035700
0.1417			3.600	70.00	39.00	9006580036000
0.1441		27	3.660	70.00	39.00	9006580036600
0.1457			3.700	70.00	39.00	9006580037000
0.1469		26	3.730	70.00	39.00	9006580037300
0.1476			3.750	70.00	39.00	9006580037500
0.1496		25	3.800	75.00	43.00	9006580038000
0.1520		24	3.860	75.00	43.00	9006580038600
0.1535			3.900	75.00	43.00	9006580039000
0.1563		5/32	3.970	75.00	43.00	9006580039700
0.1575			4.000	75.00	43.00	9006580040000
0.1591		21	4.040	75.00	43.00	9006580040400
0.1610		20	4.090	75.00	43.00	9006580040900
0.1614			4.100	75.00	43.00	9006580041000
0.1654			4.200	75.00	43.00	9006580042000
0.1661		19	4.220	75.00	43.00	9006580042200
0.1673			4.250	75.00	43.00	9006580042500
0.1693		18	4.300	80.00	47.00	9006580043000
0.1720		11/64	4.370	80.00	47.00	9006580043700
0.1732			4.400	80.00	47.00	9006580044000
0.1772		16	4.500	80.00	47.00	9006580045000
0.1799		15	4.570	80.00	47.00	9006580045700
0.1811			4.600	80.00	47.00	9006580046000
0.1850		13	4.700	80.00	47.00	9006580047000
0.1874		3/16	4.760	86.00	52.00	9006580047600
0.1890		12	4.800	86.00	52.00	9006580048000
0.1909		11	4.850	86.00	52.00	9006580048500
0.1929			4.900	86.00	52.00	9006580049000
0.1937		10	4.920	86.00	52.00	9006580049200
0.1961		9	4.980	86.00	52.00	9006580049800
0.1969			5.000	86.00	52.00	9006580050000
0.2008			5.100	86.00	52.00	9006580051000
0.2031		13/64	5.160	86.00	52.00	9006580051600
0.2047			5.200	86.00	52.00	9006580052000
0.2087			5.300	86.00	52.00	9006580053000

*Items listed in red are non-stocked items, and may take 2 - 6 weeks to receive

Series 658

Speeds & Feeds information pg 449

Diameter (d1)		Wire / letter	mm	l1 mm	l2 mm	EDP #
Dec. inch	Fract. inch					
0.2126			5.400	93.00	57.00	9006580054000
0.2165			5.500	93.00	57.00	9006580055000
0.2189	7/32		5.560	93.00	57.00	9006580055600
0.2205			5.600	93.00	57.00	9006580056000
0.2209		2	5.610	93.00	57.00	9006580056100
0.2244			5.700	93.00	57.00	9006580057000
0.2283			5.800	93.00	57.00	9006580058000
0.2323			5.900	93.00	57.00	9006580059000
0.2343	15/64		5.950	93.00	57.00	9006580059500
0.2362			6.000	93.00	57.00	9006580060000
0.2402			6.100	101.00	63.00	9006580061000
0.2421		C	6.150	101.00	63.00	9006580061500
0.2441			6.200	101.00	63.00	9006580062000
0.2480			6.300	101.00	63.00	9006580063000
0.2500	1/4	E	6.350	101.00	63.00	9006580063500
0.2520			6.400	101.00	63.00	9006580064000
0.2559			6.500	101.00	63.00	9006580065000
0.2571		F	6.530	101.00	63.00	9006580065300
0.2598			6.600	101.00	63.00	9006580066000
0.2638			6.700	101.00	63.00	9006580067000
0.2657	17/64	H	6.750	109.00	69.00	9006580067500
0.2677			6.800	109.00	69.00	9006580068000
0.2717		I	6.900	109.00	69.00	9006580069000
0.2756			7.000	109.00	69.00	9006580070000
0.2795			7.100	109.00	69.00	9006580071000
0.2811	9/32	K	7.140	109.00	69.00	9006580071400
0.2835			7.200	109.00	69.00	9006580072000
0.2874			7.300	109.00	69.00	9006580073000
0.2913			7.400	109.00	69.00	9006580074000
0.2953			7.500	109.00	69.00	9006580075000
0.2992			7.600	117.00	75.00	9006580076000
0.3031			7.700	117.00	75.00	9006580077000
0.3071			7.800	117.00	75.00	9006580078000
0.3110			7.900	117.00	75.00	9006580079000
0.3126	5/16		7.940	117.00	75.00	9006580079400
0.3150			8.000	117.00	75.00	9006580080000
0.3189			8.100	117.00	75.00	9006580081000
0.3228		P	8.200	117.00	75.00	9006580082000
0.3268			8.300	117.00	75.00	9006580083000
0.3307			8.400	117.00	75.00	9006580084000
0.3346			8.500	117.00	75.00	9006580085000
0.3386			8.600	125.00	81.00	9006580086000
0.3425			8.700	125.00	81.00	9006580087000

Diameter (d1)		Wire / letter	mm	l1 mm	l2 mm	EDP #
Dec. inch	Fract. inch					
0.3437	11/32		8.730	125.00	81.00	9006580087300
0.3445			8.750	125.00	81.00	9006580087500
0.3465			8.800	125.00	81.00	9006580088000
0.3504			8.900	125.00	81.00	9006580089000
0.3543			9.000	125.00	81.00	9006580090000
0.3594	23/64		9.130	125.00	81.00	9006580091300
0.3622			9.200	125.00	81.00	9006580092000
0.3661			9.300	125.00	81.00	9006580093000
0.3740			9.500	125.00	81.00	9006580095000
0.3748	3/8		9.520	133.00	87.00	9006580095200
0.3780			9.600	133.00	87.00	9006580096000
0.3858		W	9.800	133.00	87.00	9006580098000
0.3898			9.900	133.00	87.00	9006580099000
0.3906	25/64		9.920	133.00	87.00	9006580099200
0.3937			10.000	133.00	87.00	9006580100000
0.3976			10.100	133.00	87.00	9006580101000
0.4016			10.200	133.00	87.00	9006580102000
0.4055			10.300	133.00	87.00	9006580103000
0.4063	13/32		10.320	133.00	87.00	9006580103200
0.4134			10.500	133.00	87.00	9006580105000
0.4220	27/64		10.720	142.00	94.00	9006580107200
0.4252			10.800	142.00	94.00	9006580108000
0.4331			11.000	142.00	94.00	9006580110000
0.4374	7/16		11.110	142.00	94.00	9006580111100
0.4409			11.200	142.00	94.00	9006580112000
0.4528			11.500	142.00	94.00	9006580115000
0.4606			11.700	142.00	94.00	9006580117000
0.4689	15/32		11.910	151.00	101.00	9006580119100
0.4724			12.000	151.00	101.00	9006580120000
0.4921			12.500	151.00	101.00	9006580125000
0.5118			13.000	151.00	101.00	9006580130000

Alternative Drill Series:

- #549 HSS, GT100, 5xD, 130 pt, Bright/Nitrided lands > 2.36
- #652 HSS, GT100, 5xD, 130 pt, TiN
- #622 Cobalt, GT100, 5xD, 130 pt, Bright/Nitrided lands > 2.36
- #530 PM Cobalt, GT500, 5xD, 130 pt, FIREX®

3xD



TiN Coated



External Coolant

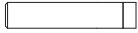

Straight Shank

Speeds & Feeds
information pg 449

Series 659

Heavy Duty

Cobalt, heavy duty (type GV120), stub length, 130° point, Form A
web thinned >2.36mm dia., standard straight shank, RH helix

Cut / Shank Dia. = h8 tolerance range

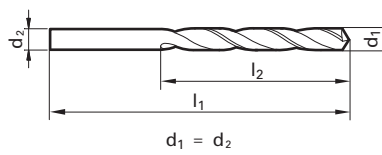

Application Materials:

- Universal Steels
- Stainless Steels
- Hardened Materials
- Ti & Ni Alloys

Twist Drills

Dec. inch	Diameter (d1)		l1 mm	l2 mm	EDP #
	Fract. inch	Wire / letter			
0.0197			20.00	3.00	9006590005000
0.0236			21.00	3.50	9006590006000
0.0256			22.00	4.00	9006590006500
0.0276			23.00	4.50	9006590007000
0.0291		69	23.00	4.50	9006590007400
0.0295			23.00	4.50	9006590007500
0.0311	1/32	68	24.00	5.00	9006590008000
0.0315			24.00	5.00	9006590008000
0.0335			24.00	5.00	9006590008500
0.0354			25.00	5.50	9006590009000
0.0374			25.00	5.50	9006590009500
0.0394			26.00	6.00	9006590010000
0.0402		60	26.00	6.00	9006590010200
0.0421		58	28.00	7.00	9006590010700
0.0429		57	28.00	7.00	9006590010900
0.0433			28.00	7.00	9006590011000
0.0453			28.00	7.00	9006590011500
0.0465		56	28.00	7.00	9006590011800
0.0469	3/64		28.00	7.00	9006590011900
0.0472			28.00	7.00	9006590012000
0.0492			28.00	7.00	9006590012500
0.0512			28.00	7.00	9006590013000
0.0520		55	28.00	7.00	9006590013200
0.0551		54	32.00	9.00	9006590014000
0.0571			32.00	9.00	9006590014500
0.0591			32.00	9.00	9006590015000
0.0594		53	34.00	10.00	9006590015100
0.0602			34.00	10.00	9006590015300
0.0618			34.00	10.00	9006590015700
0.0626	1/16		34.00	10.00	9006590015900
0.0630			34.00	10.00	9006590016000
0.0634		52	34.00	10.00	9006590016100
0.0669		51	34.00	10.00	9006590017000
0.0701		50	36.00	11.00	9006590017800
0.0709			36.00	11.00	9006590018000
0.0728		49	36.00	11.00	9006590018500
0.0748			36.00	11.00	9006590019000
0.0760		48	38.00	12.00	9006590019300
0.0776			38.00	12.00	9006590019700
0.0780	5/64		38.00	12.00	9006590019800
0.0783		47	38.00	12.00	9006590019900
0.0787			38.00	12.00	9006590020000
0.0819		45	38.00	12.00	9006590020800
0.0827			38.00	12.00	9006590021000
0.0858		44	40.00	13.00	9006590021800
0.0866			40.00	13.00	9006590022000
0.0886			40.00	13.00	9006590022500
0.0890		43	40.00	13.00	9006590022600
0.0906			40.00	13.00	9006590023000
0.0933		42	43.00	14.00	9006590023700
0.0937	3/32		43.00	14.00	9006590023800
0.0945			43.00	14.00	9006590024000
0.0961		41	43.00	14.00	9006590024400
0.0965			43.00	14.00	9006590024500

Dec. inch	Diameter (d1)		l1 mm	l2 mm	EDP #
	Fract. inch	Wire / letter			
0.0980		40	43.00	14.00	9006590024900
0.0984			43.00	14.00	9006590025000
0.0996		39	43.00	14.00	9006590025300
0.1004			43.00	14.00	9006590025500
0.1016		38	43.00	14.00	9006590025800
0.1024			43.00	14.00	9006590026000
0.1039		37	46.00	16.00	9006590026400
0.1063			46.00	16.00	9006590027000
0.1067		36	46.00	16.00	9006590027100
0.1094	7/64		46.00	16.00	9006590027800
0.1102			46.00	16.00	9006590028000
0.1110		34	46.00	16.00	9006590028200
0.1122			46.00	16.00	9006590028500
0.1142			46.00	16.00	9006590029000
0.1161		32	46.00	16.00	9006590029500
0.1181			46.00	16.00	9006590030000
0.1201		31	49.00	18.00	9006590030500
0.1220			49.00	18.00	9006590031000
0.1248	1/8		49.00	18.00	9006590031700
0.1260			49.00	18.00	9006590032000
0.1280			49.00	18.00	9006590032500
0.1283		30	49.00	18.00	9006590032600
0.1299			49.00	18.00	9006590033000
0.1339			52.00	20.00	9006590034000
0.1358		29	52.00	20.00	9006590034500
0.1378			52.00	20.00	9006590035000
0.1406	9/64	28	52.00	20.00	9006590035700
0.1417			52.00	20.00	9006590036000
0.1441		27	52.00	20.00	9006590036600
0.1457			52.00	20.00	9006590037000
0.1469		26	52.00	20.00	9006590037300
0.1496		25	55.00	22.00	9006590038000
0.1520		24	55.00	22.00	9006590038600
0.1535			55.00	22.00	9006590039000
0.1539		23	55.00	22.00	9006590039100
0.1563	5/32		55.00	22.00	9006590039700
0.1575			55.00	22.00	9006590040000
0.1591		21	55.00	22.00	9006590040400
0.1610		20	55.00	22.00	9006590040900
0.1614			55.00	22.00	9006590041000
0.1634			55.00	22.00	9006590041500
0.1654			55.00	22.00	9006590042000
0.1673			55.00	22.00	9006590042500
0.1693		18	58.00	24.00	9006590043000
0.1720	11/64		58.00	24.00	9006590043700
0.1728		17	58.00	24.00	9006590043900
0.1732			58.00	24.00	9006590044000
0.1772		16	58.00	24.00	9006590045000
0.1811			58.00	24.00	9006590046000
0.1819		14	58.00	24.00	9006590046200
0.1850		13	58.00	24.00	9006590047000
0.1874	3/16		62.00	26.00	9006590047600
0.1890		12	62.00	26.00	9006590048000
0.1909		11	62.00	26.00	9006590048500

*Items listed in red are non-stocked items, and may take 2 - 6 weeks to receive

Series 659

Speeds & Feeds information pg 449

Twist Drills

Dec. Inch	Diameter (d1)		I1 mm	I2 mm	EDP #	
	Fract. inch	Wire / letter				
0.1929			4.900	62.00	26.00	9006590049000
0.1937		10	4.920	62.00	26.00	9006590049200
0.1969			5.000	62.00	26.00	9006590050000
0.1992		8	5.060	62.00	26.00	9006590050600
0.2008			5.100	62.00	26.00	9006590051000
0.2031	13/64		5.160	62.00	26.00	9006590051600
0.2047			5.200	62.00	26.00	9006590052000
0.2055		5	5.220	62.00	26.00	9006590052200
0.2087			5.300	62.00	26.00	9006590053000
0.2091		4	5.310	66.00	28.00	9006590053100
0.2126			5.400	66.00	28.00	9006590054000
0.2165			5.500	66.00	28.00	9006590055000
0.2189	7/32		5.560	66.00	28.00	9006590055600
0.2205			5.600	66.00	28.00	9006590056000
0.2209		2	5.610	66.00	28.00	9006590056100
0.2244			5.700	66.00	28.00	9006590057000
0.2283			5.800	66.00	28.00	9006590058000
0.2323			5.900	66.00	28.00	9006590059000
0.2339		A	5.940	66.00	28.00	9006590059400
0.2362			6.000	66.00	28.00	9006590060000
0.2378		B	6.040	70.00	31.00	9006590060400
0.2402			6.100	70.00	31.00	9006590061000
0.2421		C	6.150	70.00	31.00	9006590061500
0.2441			6.200	70.00	31.00	9006590062000
0.2480			6.300	70.00	31.00	9006590063000
0.2500	1/4	E	6.350	70.00	31.00	9006590063500
0.2520			6.400	70.00	31.00	9006590064000
0.2559			6.500	70.00	31.00	9006590065000
0.2571		F	6.530	70.00	31.00	9006590065300
0.2598			6.600	70.00	31.00	9006590066000
0.2638			6.700	70.00	31.00	9006590067000
0.2657	17/64	H	6.750	74.00	34.00	9006590067500
0.2677			6.800	74.00	34.00	9006590068000
0.2717		I	6.900	74.00	34.00	9006590069000
0.2756			7.000	74.00	34.00	9006590070000
0.2795			7.100	74.00	34.00	9006590071000
0.2811	9/32	K	7.140	74.00	34.00	9006590071400
0.2835			7.200	74.00	34.00	9006590072000
0.2874			7.300	74.00	34.00	9006590073000
0.2902		L	7.370	74.00	34.00	9006590073700
0.2913			7.400	74.00	34.00	9006590074000
0.2953			7.500	74.00	34.00	9006590075000
0.2969	19/64		7.540	79.00	37.00	9006590075400
0.3031			7.700	79.00	37.00	9006590077000
0.3071			7.800	79.00	37.00	9006590078000
0.3126	5/16		7.940	79.00	37.00	9006590079400
0.3150			8.000	79.00	37.00	9006590080000
0.3189			8.100	79.00	37.00	9006590081000
0.3228		P	8.200	79.00	37.00	9006590082000
0.3268			8.300	79.00	37.00	9006590083000
0.3307			8.400	79.00	37.00	9006590084000

Dec. Inch	Diameter (d1)		I1 mm	I2 mm	EDP #	
	Fract. inch	Wire / letter				
0.3346			8.500	79.00	37.00	9006590085000
0.3386			8.600	84.00	40.00	9006590086000
0.3425			8.700	84.00	40.00	9006590087000
0.3437	11/32		8.730	84.00	40.00	9006590087300
0.3465			8.800	84.00	40.00	9006590088000
0.3480		S	8.840	84.00	40.00	9006590088400
0.3543			9.000	84.00	40.00	9006590090000
0.3583			9.100	84.00	40.00	9006590091000
0.3594	23/64		9.130	84.00	40.00	9006590091300
0.3622			9.200	84.00	40.00	9006590092000
0.3661			9.300	84.00	40.00	9006590093000
0.3740			9.500	84.00	40.00	9006590095000
0.3748	3/8		9.520	89.00	43.00	9006590095200
0.3780			9.600	89.00	43.00	9006590096000
0.3819			9.700	89.00	43.00	9006590097000
0.3858		W	9.800	89.00	43.00	9006590098000
0.3898			9.900	89.00	43.00	9006590099000
0.3906	25/64		9.920	89.00	43.00	9006590099200
0.3937			10.000	89.00	43.00	9006590100000
0.4016			10.200	89.00	43.00	9006590102000
0.4035			10.250	89.00	43.00	9006590102500
0.4063	13/32		10.320	89.00	43.00	9006590103200
0.4134			10.500	89.00	43.00	9006590105000
0.4220	27/64		10.720	95.00	47.00	9006590107200
0.4291			10.900	95.00	47.00	9006590109000
0.4331			11.000	95.00	47.00	9006590110000
0.4374	7/16		11.110	95.00	47.00	9006590111100
0.4528			11.500	95.00	47.00	9006590115000
0.4724			12.000	102.00	51.00	9006590120000
0.4764			12.100	102.00	51.00	9006590121000
0.4803			12.200	102.00	51.00	9006590122000
0.4843	31/64		12.300	102.00	51.00	9006590123000
0.4921			12.500	102.00	51.00	9006590125000
0.5000	1/2		12.700	102.00	51.00	9006590127000
0.5039			12.800	102.00	51.00	9006590128000
0.5118			13.000	102.00	51.00	9006590130000
0.5236			13.300	107.00	54.00	9006590133000
0.5311	17/32		13.490	107.00	54.00	9006590134900
0.5512			14.000	107.00	54.00	9006590140000
0.5626	9/16		14.290	111.00	56.00	9006590142900
0.5709			14.500	111.00	56.00	9006590145000
0.5906			15.000	111.00	56.00	9006590150000
0.6102			15.500	115.00	58.00	9006590155000

Alternative Drill Series:

- #329 Cobalt, GV120, 3xD, 130 pt., Bright/Steam Oxide > 2.36
- #524 Cobalt, GU500, 3xD, 118 pt., Bright
- #610, Cobalt, GP, 3xD, 130 pt., Bright

Micro



TiN coated



External Coolant



Reinforced Straight Shank

Speeds & Feeds
information pg 450

Series 660

Micro-Precision

Cobalt, Micro-Precision (Type N), 118° point, reinforced straight shank, RH helix

Shank Dia. = h8 tolerance range, Cut Dia. +0 / -0.004

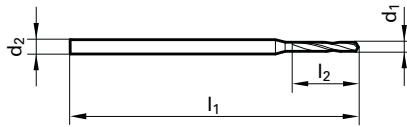

Application Materials:

- General Steels/ Brass
- Universal Steels
- Stainless Steels
- Hardened Materials
- Cast Iron
- Ti & Ni Alloys

Diameter (d1)		Shank dia.	l1 mm	l2 mm	EDP #
Dec. inch	Fract. inch / Wire / letter				
0.0050		1.000	25.00	0.80	9006600001280
0.0063	96	1.000	25.00	1.10	9006600001600
0.0067	95	1.000	25.00	1.10	9006600001700
0.0071	94	1.000	25.00	1.10	9006600001800
0.0075	93	1.000	25.00	1.10	9006600001900
0.0079	92	1.000	25.00	1.50	9006600002000
0.0083	91	1.000	25.00	1.50	9006600002100
0.0087	90	1.000	25.00	1.50	9006600002200
0.0091	89	1.000	25.00	1.50	9006600002300
0.0093		1.000	25.00	1.50	9006600002350
0.0094	88	1.000	25.00	1.50	9006600002400
0.0096		1.000	25.00	1.90	9006600002450
0.0098	87	1.000	25.00	1.90	9006600002500
0.0100		1.000	25.00	1.90	9006600002550
0.0102		1.000	25.00	1.90	9006600002600
0.0104		1.000	25.00	1.90	9006600002650
0.0106	86	1.000	25.00	1.90	9006600002700
0.0110	85	1.000	25.00	1.90	9006600002800
0.0114	84	1.000	25.00	1.90	9006600002900
0.0118		1.000	25.00	1.90	9006600003000
0.0120		1.000	25.00	2.40	9006600003050
0.0122	83	1.000	25.00	2.40	9006600003100
0.0126	82	1.000	25.00	2.40	9006600003200
0.0130	81	1.000	25.00	2.40	9006600003300
0.0134	80	1.000	25.00	2.40	9006600003400
0.0138		1.000	25.00	2.40	9006600003500
0.0142		1.000	25.00	2.40	9006600003600
0.0146	79	1.000	25.00	2.40	9006600003700
0.0150		1.000	25.00	2.40	9006600003800
0.0154		1.000	25.00	3.00	9006600003900
0.0157	1/64	1.000	25.00	3.00	9006600004000
0.0161	78	1.000	25.00	3.00	9006600004100
0.0165		1.000	25.00	3.00	9006600004200
0.0169		1.000	25.00	3.00	9006600004300
0.0173		1.000	25.00	3.00	9006600004400
0.0177		1.000	25.00	3.00	9006600004500
0.0181	77	1.000	25.00	3.00	9006600004600
0.0185		1.000	25.00	3.00	9006600004700
0.0189		1.000	25.00	3.00	9006600004800
0.0193		1.000	25.00	3.40	9006600004900
0.0197		1.000	25.00	3.40	9006600005000
0.0201	76	1.000	25.00	3.40	9006600005100
0.0205		1.000	25.00	3.40	9006600005200
0.0209	75	1.000	25.00	3.40	9006600005300
0.0213		1.000	25.00	3.90	9006600005400
0.0217		1.000	25.00	3.90	9006600005500
0.0220		1.000	25.00	3.90	9006600005600
0.0224	74	1.000	25.00	3.90	9006600005700
0.0228		1.000	25.00	3.90	9006600005800
0.0232		1.000	25.00	3.90	9006600005900
0.0236		1.000	25.00	3.90	9006600006000
0.0240	73	1.000	25.00	4.20	9006600006100
0.0244		1.000	25.00	4.20	9006600006200
0.0248		1.000	25.00	4.20	9006600006300
0.0252	72	1.000	25.00	4.20	9006600006400

Diameter (d1)		Shank dia.	l1 mm	l2 mm	EDP #		
Dec. inch	Fract. inch / Wire / letter						
0.0256		1.000	25.00	4.20	9006600006500		
0.0260	71	1.000	25.00	4.20	9006600006600		
0.0264		1.000	25.00	4.20	9006600006700		
0.0268		1.000	25.00	4.80	9006600006800		
0.0272		1.000	25.00	4.80	9006600006900		
0.0276		1.000	25.00	4.80	9006600007000		
0.0280	70	1.000	25.00	4.80	9006600007100		
0.0283		1.000	25.00	4.80	9006600007200		
0.0287		1.000	25.00	4.80	9006600007300		
0.0291	69	1.000	25.00	4.80	9006600007400		
0.0295		1.000	25.00	4.80	9006600007500		
0.0299		1.000	25.00	5.30	9006600007600		
0.0303		1.000	25.00	5.30	9006600007700		
0.0307		1.000	25.00	5.30	9006600007800		
0.0311	1/32	68	0.790	1.000	25.00	5.30	9006600007900
0.0315		1.500	25.00	5.30	9006600008000		
0.0319	67	0.810	1.500	25.00	5.30	9006600008100	
0.0323		1.500	25.00	5.30	9006600008200		
0.0327		1.500	25.00	5.30	9006600008300		
0.0331	66	0.840	1.500	25.00	5.30	9006600008400	
0.0335		1.500	25.00	5.30	9006600008500		
0.0339		1.500	25.00	6.00	9006600008600		
0.0343		1.500	25.00	6.00	9006600008700		
0.0346		1.500	25.00	6.00	9006600008800		
0.0354		1.500	25.00	6.00	9006600009000		
0.0358	64	0.910	1.500	25.00	6.00	9006600009100	
0.0370	63	0.940	1.500	25.00	6.00	9006600009400	
0.0374		1.500	25.00	6.00	9006600009500		
0.0382	62	0.970	1.500	25.00	6.80	9006600009700	
0.0386		1.500	25.00	6.80	9006600009800		
0.0394		1.000	1.500	25.00	6.80	9006600010000	
0.0402	60	1.020	1.500	25.00	6.80	9006600010200	
0.0409	59	1.040	1.500	25.00	6.80	9006600010400	
0.0413		1.500	25.00	6.80	9006600010500		
0.0421	58	1.070	1.500	25.00	7.60	9006600010700	
0.0425		1.080	1.500	25.00	7.60	9006600010800	
0.0433		1.100	1.500	25.00	7.60	9006600011000	
0.0453		1.150	1.500	25.00	7.60	9006600011500	
0.0465	56	1.180	1.500	25.00	7.60	9006600011800	
0.0469	3/64	1.190	1.500	25.00	8.50	9006600011900	
0.0472		1.200	1.500	25.00	8.50	9006600012000	
0.0492		1.250	1.500	25.00	8.50	9006600012500	
0.0512		1.300	1.500	25.00	8.50	9006600013000	
0.0531		1.350	1.500	25.00	9.50	9006600013500	
0.0547		1.390	1.500	25.00	9.50	9006600013900	
0.0551	54	1.400	1.500	25.00	9.50	9006600014000	
0.0559		1.420	1.500	25.00	9.50	9006600014200	
0.0571		1.450	1.500	25.00	9.50	9006600014500	
0.0591		1.500	2.000	30.00	9.50	9006600015000	
0.0709		1.800	2.000	30.00	11.80	9006600018000	

Alternative Drill Series:

- #301 Cobalt, Type N, 4xD, 118 pt, Bright
- #6400 Carbide, Type N, 4xD, 140 pt, Super-A

*Items listed in red are non-stocked items, and may take 2 - 6 weeks to receive

5xD

Series 664

Application Materials:



TiN coated



External Coolant







Straight Shank

Speeds & Feeds
information pg 450

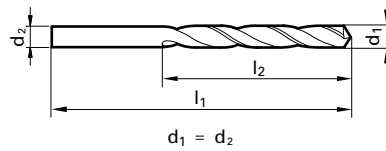
General Purpose, LH helix
HSS, general purpose (Type N), jobber length, 118° point, Form A
web thinned >2.36mm dia., standard straight shank, LH cut

Cut / Shank Dia. = h8 tolerance range



-  General Steels/Brass
-  Universal Steels
-  Cast Iron

Diameter (d1)		Wire / letter	mm	l1 mm	l2 mm	EDP #
Dec. inch	Fract. inch					
0.0157	1/64		0.400	20.00	5.00	9006640004000
0.0165			0.420	20.00	5.00	9006640004200
0.0169			0.430	20.00	5.00	9006640004300
0.0177			0.450	20.00	5.00	9006640004500
0.0236			0.600	24.00	7.00	9006640006000
0.0264			0.670	26.00	8.00	9006640006700
0.0295			0.750	28.00	9.00	9006640007500
0.0303			0.770	30.00	10.00	9006640007700
0.0315			0.800	30.00	10.00	9006640008000
0.0354			0.900	32.00	11.00	9006640009000
0.0366			0.930	32.00	11.00	9006640009300
0.0374			0.950	32.00	11.00	9006640009500
0.0382		62	0.970	34.00	12.00	9006640009700
0.0394			1.000	34.00	12.00	9006640010000
0.0413			1.050	34.00	12.00	9006640010500
0.0421		58	1.070	36.00	14.00	9006640010700
0.0429		57	1.090	36.00	14.00	9006640010900
0.0433			1.100	36.00	14.00	9006640011000
0.0453			1.150	36.00	14.00	9006640011500
0.0465		56	1.180	36.00	14.00	9006640011800
0.0469		3/64	1.190	38.00	16.00	9006640011900
0.0472			1.200	38.00	16.00	9006640012000
0.0492			1.250	38.00	16.00	9006640012500
0.0512			1.300	38.00	16.00	9006640013000
0.0520		55	1.320	38.00	16.00	9006640013200
0.0531			1.350	40.00	18.00	9006640013500
0.0551		54	1.400	40.00	18.00	9006640014000
0.0559			1.420	40.00	18.00	9006640014200
0.0571			1.450	40.00	18.00	9006640014500
0.0591			1.500	40.00	18.00	9006640015000
0.0610			1.550	43.00	20.00	9006640015500
0.0626		1/16	1.590	43.00	20.00	9006640015900
0.0630			1.600	43.00	20.00	9006640016000
0.0650			1.650	43.00	20.00	9006640016500
0.0669		51	1.700	43.00	20.00	9006640017000
0.0689			1.750	46.00	22.00	9006640017500
0.0709			1.800	46.00	22.00	9006640018000
0.0717			1.820	46.00	22.00	9006640018200
0.0728		49	1.850	46.00	22.00	9006640018500
0.0748			1.900	46.00	22.00	9006640019000
0.0787			2.000	49.00	24.00	9006640020000
0.0807			2.050	49.00	24.00	9006640020500
0.0827			2.100	49.00	24.00	9006640021000
0.0846			2.150	53.00	27.00	9006640021500
0.0866			2.200	53.00	27.00	9006640022000
0.0906			2.300	53.00	27.00	9006640023000
0.0937		3/32	2.380	57.00	30.00	9006640023800
0.0945			2.400	57.00	30.00	9006640024000
0.0965			2.450	57.00	30.00	9006640024500
0.0984			2.500	57.00	30.00	9006640025000
0.0996		39	2.530	57.00	30.00	9006640025300
0.1016		38	2.580	57.00	30.00	9006640025800
0.1024			2.600	57.00	30.00	9006640026000
0.1063			2.700	61.00	33.00	9006640027000
0.1067		36	2.710	61.00	33.00	9006640027100
0.1083			2.750	61.00	33.00	9006640027500

Diameter (d1)		Wire / letter	mm	l1 mm	l2 mm	EDP #
Dec. inch	Fract. inch					
0.1094	7/64		2.780	61.00	33.00	9006640027800
0.1102			2.800	61.00	33.00	9006640028000
0.1142			2.900	61.00	33.00	9006640029000
0.1161		32	2.950	61.00	33.00	9006640029500
0.1181			3.000	61.00	33.00	9006640030000
0.1201		31	3.050	65.00	36.00	9006640030500
0.1220			3.100	65.00	36.00	9006640031000
0.1248		1/8	3.170	65.00	36.00	9006640031700
0.1260			3.200	65.00	36.00	9006640032000
0.1299			3.300	65.00	36.00	9006640033000
0.1339			3.400	70.00	39.00	9006640034000
0.1358		29	3.450	70.00	39.00	9006640034500
0.1378			3.500	70.00	39.00	9006640035000
0.1406		9/64	3.570	70.00	39.00	9006640035700
0.1417			3.600	70.00	39.00	9006640036000
0.1457			3.700	70.00	39.00	9006640037000
0.1496		25	3.800	75.00	43.00	9006640038000
0.1535			3.900	75.00	43.00	9006640039000
0.1563		5/32	3.970	75.00	43.00	9006640039700
0.1575			4.000	75.00	43.00	9006640040000
0.1614			4.100	75.00	43.00	9006640041000
0.1654			4.200	75.00	43.00	9006640042000
0.1693		18	4.300	80.00	47.00	9006640043000
0.1720		11/64	4.370	80.00	47.00	9006640043700
0.1732			4.400	80.00	47.00	9006640044000
0.1772		16	4.500	80.00	47.00	9006640045000
0.1811			4.600	80.00	47.00	9006640046000
0.1850		13	4.700	80.00	47.00	9006640047000
0.1874		3/16	4.760	86.00	52.00	9006640047600
0.1890		12	4.800	86.00	52.00	9006640048000
0.1929			4.900	86.00	52.00	9006640049000
0.1969			5.000	86.00	52.00	9006640050000
0.1992		8	5.060	86.00	52.00	9006640050600
0.2008			5.100	86.00	52.00	9006640051000
0.2031		13/64	5.160	86.00	52.00	9006640051600
0.2047			5.200	86.00	52.00	9006640052000
0.2087			5.300	86.00	52.00	9006640053000
0.2126			5.400	93.00	57.00	9006640054000
0.2165			5.500	93.00	57.00	9006640055000
0.2189		7/32	5.560	93.00	57.00	9006640055600
0.2205			5.600	93.00	57.00	9006640056000
0.2244			5.700	93.00	57.00	9006640057000
0.2283			5.800	93.00	57.00	9006640058000
0.2323			5.900	93.00	57.00	9006640059000
0.2362			6.000	93.00	57.00	9006640060000
0.2402			6.100	101.00	63.00	9006640061000
0.2441			6.200	101.00	63.00	9006640062000
0.2480			6.300	101.00	63.00	9006640063000
0.2500		1/4	6.350	101.00	63.00	9006640063500
0.2559			6.500	101.00	63.00	9006640065000
0.2969		19/64	7.540	117.00	75.00	9006640075400
0.3071			7.800	117.00	75.00	9006640078000
0.3437		11/32	8.730	125.00	81.00	9006640087300
0.3594		23/64	9.130	125.00	81.00	9006640091300
0.4016			10.200	133.00	87.00	9006640102000

10xD



TiN coated



External Coolant



Straight Shank, DIN tang
>3mm dia.

Speeds & Feeds
information pg 451

Series 666

General Purpose

HSS, general purpose (Type N), bushing length, 118° point, Form A web thinned >2.36mm dia., straight shank (tang >3mm) shank, RH helix

Cut / Shank Dia. = h8 tolerance range

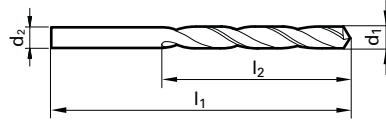

$$d_1 = d_2$$

Application Materials:

- General Steels/Brass
- Universal Steels
- Cast Iron

Twist Drills

Dec. inch	Diameter (d1)		mm	l1 mm	l2 mm	EDP #
	Fract. inch	Wire / letter				
0.0394			1.000	48.00	26.00	9006660010000
0.0433			1.100	50.00	28.00	9006660011000
0.0472			1.200	52.00	30.00	9006660012000
0.0512			1.300	52.00	30.00	9006660013000
0.0551		54	1.400	55.00	33.00	9006660014000
0.0591			1.500	55.00	33.00	9006660015000
0.0630			1.600	58.00	35.00	9006660016000
0.0669		51	1.700	58.00	35.00	9006660017000
0.0709			1.800	62.00	38.00	9006660018000
0.0748			1.900	62.00	38.00	9006660019000
0.0780		5/64	1.980	66.00	41.00	9006660019800
0.0787			2.000	66.00	41.00	9006660020000
0.0827			2.100	66.00	41.00	9006660021000
0.0866			2.200	70.00	44.00	9006660022000
0.0906			2.300	70.00	44.00	9006660023000
0.0945			2.400	74.00	47.00	9006660024000
0.0984			2.500	74.00	47.00	9006660025000
0.1024			2.600	74.00	47.00	9006660026000
0.1063			2.700	79.00	51.00	9006660027000
0.1102			2.800	79.00	51.00	9006660028000
0.1142			2.900	79.00	51.00	9006660029000
0.1181			3.000	79.00	51.00	9006660030000
0.1220			3.100	84.00	55.00	9006660031000
0.1260			3.200	84.00	55.00	9006660032000
0.1299			3.300	84.00	55.00	9006660033000
0.1339			3.400	91.00	60.00	9006660034000
0.1378			3.500	91.00	60.00	9006660035000
0.1406		9/64	3.570	91.00	60.00	9006660035700
0.1417			3.600	91.00	60.00	9006660036000
0.1457			3.700	91.00	60.00	9006660037000
0.1496		25	3.800	96.00	64.00	9006660038000
0.1535			3.900	96.00	64.00	9006660039000
0.1575			4.000	96.00	64.00	9006660040000
0.1614			4.100	96.00	64.00	9006660041000
0.1654			4.200	96.00	64.00	9006660042000
0.1693		18	4.300	102.00	69.00	9006660043000
0.1732			4.400	102.00	69.00	9006660044000
0.1772		16	4.500	102.00	69.00	9006660045000
0.1811			4.600	102.00	69.00	9006660046000

Dec. inch	Diameter (d1)		mm	l1 mm	l2 mm	EDP #
	Fract. inch	Wire / letter				
0.1890		12	4.800	108.00	74.00	9006660048000
0.1929			4.900	108.00	74.00	9006660049000
0.1969			5.000	108.00	74.00	9006660050000
0.2008			5.100	108.00	74.00	9006660051000
0.2047			5.200	108.00	74.00	9006660052000
0.2087			5.300	108.00	74.00	9006660053000
0.2126			5.400	116.00	80.00	9006660054000
0.2165			5.500	116.00	80.00	9006660055000
0.2205			5.600	116.00	80.00	9006660056000
0.2244			5.700	116.00	80.00	9006660057000
0.2283			5.800	116.00	80.00	9006660058000
0.2362			6.000	116.00	80.00	9006660060000
0.2402			6.100	124.00	86.00	9006660061000
0.2441			6.200	124.00	86.00	9006660062000
0.2480			6.300	124.00	86.00	9006660063000
0.2559			6.500	124.00	86.00	9006660065000
0.2598			6.600	124.00	86.00	9006660066000
0.2638			6.700	124.00	86.00	9006660067000
0.2677			6.800	133.00	93.00	9006660068000
0.2717		I	6.900	133.00	93.00	9006660069000
0.2756			7.000	133.00	93.00	9006660070000
0.2835			7.200	133.00	93.00	9006660072000
0.2874			7.300	133.00	93.00	9006660073000
0.2953			7.500	133.00	93.00	9006660075000
0.3031			7.700	142.00	100.00	9006660077000
0.3071			7.800	142.00	100.00	9006660078000
0.3110			7.900	142.00	100.00	9006660079000
0.3126		5/16	7.940	142.00	100.00	9006660079400
0.3150			8.000	142.00	100.00	9006660080000
0.3228		P	8.200	142.00	100.00	9006660082000
0.3307			8.400	142.00	100.00	9006660084000
0.3346			8.500	142.00	100.00	9006660085000
0.3543			9.000	151.00	107.00	9006660090000
0.4528			11.500	173.00	125.00	9006660115000

Alternative Drill Series:

#667 HSS, GP, 10xD, 118 pt, TiN

*Items listed in red are non-stocked items, and may take 2 - 6 weeks to receive

>10xD



TiN coated



External Coolant



Straight Shank

Speeds & Feeds
information pg 451

Series 667

General Purpose

HSS, general purpose (Type N), taper length, 118° point, Form A web thinned >2.36mm dia., standard straight shank, RH helix

Cut / Shank Dia. = h8 tolerance range

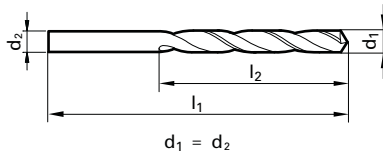

Application Materials:

- General Steels/Brass
- Universal Steels
- Cast Iron

Dec. inch	Diameter (d1)		l1 mm	l2 mm	EDP #
	Fract. inch	Wire / letter			
0.0197			32.00	12.00	9006670005000
0.0236			35.00	15.00	9006670006000
0.0256			38.00	18.00	9006670006500
0.0276			42.00	21.00	9006670007000
0.0295			42.00	21.00	9006670007500
0.0315			46.00	25.00	9006670008000
0.0335			46.00	25.00	9006670008500
0.0354			51.00	29.00	9006670009000
0.0374			51.00	29.00	9006670009500
0.0394			56.00	33.00	9006670010000
0.0413			56.00	33.00	9006670010500
0.0433			60.00	37.00	9006670011000
0.0453			60.00	37.00	9006670011500
0.0472			65.00	41.00	9006670012000
0.0492			65.00	41.00	9006670012500
0.0512			65.00	41.00	9006670013000
0.0531			70.00	45.00	9006670013500
0.0551		54	70.00	45.00	9006670014000
0.0571			70.00	45.00	9006670014500
0.0591			70.00	45.00	9006670015000
0.0610			76.00	50.00	9006670015500
0.0626	1/16		76.00	50.00	9006670015900
0.0630			76.00	50.00	9006670016000
0.0650			76.00	50.00	9006670016500
0.0669		51	76.00	50.00	9006670017000
0.0689			80.00	53.00	9006670017500
0.0709			80.00	53.00	9006670018000
0.0728		49	80.00	53.00	9006670018500
0.0748			80.00	53.00	9006670019000
0.0760		48	85.00	56.00	9006670019300
0.0768			85.00	56.00	9006670019500
0.0780	5/64		85.00	56.00	9006670019800
0.0787			85.00	56.00	9006670020000
0.0807			85.00	56.00	9006670020500
0.0827			85.00	56.00	9006670021000
0.0866			90.00	59.00	9006670022000
0.0886			90.00	59.00	9006670022500
0.0906			90.00	59.00	9006670023000
0.0925			90.00	59.00	9006670023500
0.0937	3/32		95.00	62.00	9006670023800
0.0945			95.00	62.00	9006670024000
0.0961		41	95.00	62.00	9006670024400
0.0965			95.00	62.00	9006670024500
0.0984			95.00	62.00	9006670025000
0.1004			95.00	62.00	9006670025500
0.1024			95.00	62.00	9006670026000
0.1043			95.00	62.00	9006670026500
0.1063			100.00	66.00	9006670027000
0.1083			100.00	66.00	9006670027500
0.1094	7/64		100.00	66.00	9006670027800
0.1102			100.00	66.00	9006670028000
0.1122			100.00	66.00	9006670028500
0.1142			100.00	66.00	9006670029000
0.1161		32	100.00	66.00	9006670029500

Dec. inch	Diameter (d1)		l1 mm	l2 mm	EDP #
	Fract. inch	Wire / letter			
0.1181			100.00	66.00	9006670030000
0.1201		31	106.00	69.00	9006670030500
0.1220			106.00	69.00	9006670031000
0.1240			106.00	69.00	9006670031500
0.1248	1/8		106.00	69.00	9006670031700
0.1260			106.00	69.00	9006670032000
0.1280			106.00	69.00	9006670032500
0.1299			106.00	69.00	9006670033000
0.1319			106.00	69.00	9006670033500
0.1339			112.00	73.00	9006670034000
0.1378			112.00	73.00	9006670035000
0.1398			112.00	73.00	9006670035500
0.1406	9/64	28	112.00	73.00	9006670035700
0.1417			112.00	73.00	9006670036000
0.1437			112.00	73.00	9006670036500
0.1457			112.00	73.00	9006670037000
0.1496		25	119.00	78.00	9006670038000
0.1516			119.00	78.00	9006670038500
0.1535			119.00	78.00	9006670039000
0.1555			119.00	78.00	9006670039500
0.1563	5/32		119.00	78.00	9006670039700
0.1575			119.00	78.00	9006670040000
0.1594			119.00	78.00	9006670040500
0.1614			119.00	78.00	9006670041000
0.1654			119.00	78.00	9006670042000
0.1673			119.00	78.00	9006670042500
0.1693		18	126.00	82.00	9006670043000
0.1720	11/64		126.00	82.00	9006670043700
0.1732			126.00	82.00	9006670044000
0.1772		16	126.00	82.00	9006670045000
0.1811			126.00	82.00	9006670046000
0.1850		13	126.00	82.00	9006670047000
0.1870			126.00	82.00	9006670047500
0.1874	3/16		132.00	87.00	9006670047600
0.1890		12	132.00	87.00	9006670048000
0.1909		11	132.00	87.00	9006670048500
0.1929			132.00	87.00	9006670049000
0.1937		10	132.00	87.00	9006670049200
0.1961		9	132.00	87.00	9006670049800
0.1969			132.00	87.00	9006670050000
0.2008			132.00	87.00	9006670051000
0.2031	13/64		132.00	87.00	9006670051600
0.2047			132.00	87.00	9006670052000
0.2067			132.00	87.00	9006670052500
0.2087			132.00	87.00	9006670053000
0.2126			139.00	91.00	9006670054000
0.2165			139.00	91.00	9006670055000
0.2189	7/32		139.00	91.00	9006670055600
0.2205			139.00	91.00	9006670056000
0.2209		2	139.00	91.00	9006670056100
0.2244			139.00	91.00	9006670057000
0.2280		1	139.00	91.00	9006670057900
0.2283			139.00	91.00	9006670058000
0.2323			139.00	91.00	9006670059000

Series 667

Speeds & Feeds information pg 451

Twist Drills

Diameter (d1)			I1 mm	I2 mm	EDP #	
Dec. inch	Fract. inch	Wire / letter				mm
0.2362			6.000	139.00	91.00	9006670060000
0.2402			6.100	148.00	97.00	9006670061000
0.2441			6.200	148.00	97.00	9006670062000
0.2461		D	6.250	148.00	97.00	9006670062500
0.2480			6.300	148.00	97.00	9006670063000
0.2500	1/4	E	6.350	148.00	97.00	9006670063500
0.2520			6.400	148.00	97.00	9006670064000
0.2559			6.500	148.00	97.00	9006670065000
0.2598			6.600	148.00	97.00	9006670066000
0.2638			6.700	148.00	97.00	9006670067000
0.2657	17/64	H	6.750	156.00	102.00	9006670067500
0.2677			6.800	156.00	102.00	9006670068000
0.2717		I	6.900	156.00	102.00	9006670069000
0.2756			7.000	156.00	102.00	9006670070000
0.2795			7.100	156.00	102.00	9006670071000
0.2811	9/32	K	7.140	156.00	102.00	9006670071400
0.2835			7.200	156.00	102.00	9006670072000
0.2874			7.300	156.00	102.00	9006670073000
0.2902		L	7.370	156.00	102.00	9006670073700
0.2913			7.400	156.00	102.00	9006670074000
0.2953			7.500	156.00	102.00	9006670075000
0.2969	19/64		7.540	165.00	109.00	9006670075400
0.3031			7.700	165.00	109.00	9006670077000
0.3071			7.800	165.00	109.00	9006670078000
0.3110			7.900	165.00	109.00	9006670079000
0.3126	5/16		7.940	165.00	109.00	9006670079400
0.3150			8.000	165.00	109.00	9006670080000
0.3189			8.100	165.00	109.00	9006670081000
0.3228		P	8.200	165.00	109.00	9006670082000
0.3268			8.300	165.00	109.00	9006670083000
0.3307			8.400	165.00	109.00	9006670084000
0.3346			8.500	165.00	109.00	9006670085000
0.3386			8.600	175.00	115.00	9006670086000
0.3425			8.700	175.00	115.00	9006670087000
0.3437	11/32		8.730	175.00	115.00	9006670087300
0.3465			8.800	175.00	115.00	9006670088000
0.3504			8.900	175.00	115.00	9006670089000
0.3543			9.000	175.00	115.00	9006670090000
0.3583			9.100	175.00	115.00	9006670091000
0.3594	23/64		9.130	175.00	115.00	9006670091300
0.3622			9.200	175.00	115.00	9006670092000
0.3661			9.300	175.00	115.00	9006670093000
0.3701			9.400	175.00	115.00	9006670094000
0.3740			9.500	175.00	115.00	9006670095000
0.3748	3/8		9.520	184.00	121.00	9006670095200
0.3780			9.600	184.00	121.00	9006670096000
0.3819			9.700	184.00	121.00	9006670097000
0.3858		W	9.800	184.00	121.00	9006670098000

Diameter (d1)			I1 mm	I2 mm	EDP #	
Dec. inch	Fract. inch	Wire / letter				mm
0.3898			9.900	184.00	121.00	9006670099000
0.3906	25/64		9.920	184.00	121.00	9006670099200
0.3937			10.000	184.00	121.00	9006670100000
0.4016			10.200	184.00	121.00	9006670102000
0.4063	13/32		10.320	184.00	121.00	9006670103200
0.4134			10.500	184.00	121.00	9006670105000
0.4173			10.600	184.00	121.00	9006670106000
0.4220	27/64		10.720	195.00	128.00	9006670107200
0.4252			10.800	195.00	128.00	9006670108000
0.4331			11.000	195.00	128.00	9006670110000
0.4374	7/16		11.110	195.00	128.00	9006670111100
0.4528			11.500	195.00	128.00	9006670115000
0.4531	29/64		11.510	195.00	128.00	9006670115100
0.4689	15/32		11.910	205.00	134.00	9006670119100
0.4724			12.000	205.00	134.00	9006670120000
0.4921			12.500	205.00	134.00	9006670125000
0.5000	1/2		12.700	205.00	134.00	9006670127000
0.5118			13.000	205.00	134.00	9006670130000
0.5311	17/32		13.490	214.00	140.00	9006670134900
0.5315			13.500	214.00	140.00	9006670135000
0.5433			13.800	214.00	140.00	9006670138000
0.5469	35/64		13.890	214.00	140.00	9006670138900
0.5512			14.000	214.00	140.00	9006670140000
0.5626	9/16		14.290	220.00	144.00	9006670142900
0.5709			14.500	220.00	144.00	9006670145000
0.5780	37/64		14.680	220.00	144.00	9006670146800
0.5807			14.750	220.00	144.00	9006670147500
0.5906			15.000	220.00	144.00	9006670150000
0.5937	19/32		15.080	227.00	149.00	9006670150800
0.6094	39/64		15.480	227.00	149.00	9006670154800
0.6102			15.500	227.00	149.00	9006670155000
0.6248	5/8		15.870	227.00	149.00	9006670158700
0.6299			16.000	227.00	149.00	9006670160000
0.6496			16.500	235.00	154.00	9006670165000
0.6563	21/32		16.670	235.00	154.00	9006670166700
0.6594			16.750	235.00	154.00	9006670167500
0.6693			17.000	235.00	154.00	9006670170000
0.6874	11/16		17.460	241.00	158.00	9006670174600
0.7087			18.000	241.00	158.00	9006670180000
0.7185			18.250	247.00	162.00	9006670182500

Alternative Drill Series:

- #217 HSS, GP, 10xD, 118 pt, Bright/Steam Oxide > 2.36
- #317 Cobalt, GP, 10xD, 118 pt, Oxide
- #617 Cobalt, Ti, 10xD, 130 pt, Bright/Steam Oxide > 2.36
- #669 Cobalt, Ti, 10xD, 130 pt, TiN

*Items listed in red are non-stocked items, and may take 2 - 6 weeks to receive

10xD**S**

TiN coated



External Coolant



Straight Shank

Speeds & Feeds
information pg 452**Series 668****GT 100 Parabolic**HSS, GT 100 deep hole, taper length, 130° point, Form A
web thinned all dia., standard straight shank, RH helix

Cut / Shank Dia. = h8 tolerance range

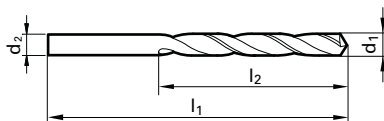
 $d_1 = d_2$

Application Materials:



General Steels/Brass



Aluminum & Alloys



Universal Steels

Dec. inch	Diameter (d1)		l1 mm	l2 mm	EDP #
	Fract. inch	Wire / letter			
0.0394			56.00	33.00	9006680010000
0.0429		57	60.00	37.00	9006680010900
0.0433			60.00	37.00	9006680011000
0.0465		56	60.00	37.00	9006680011800
0.0469		3/64	65.00	41.00	9006680011900
0.0472			65.00	41.00	9006680012000
0.0512			65.00	41.00	9006680013000
0.0520		55	65.00	41.00	9006680013200
0.0551		54	70.00	45.00	9006680014000
0.0591			70.00	45.00	9006680015000
0.0594		53	76.00	50.00	9006680015100
0.0626		1/16	76.00	50.00	9006680015900
0.0630			76.00	50.00	9006680016000
0.0650			76.00	50.00	9006680016500
0.0669		51	76.00	50.00	9006680017000
0.0709			80.00	53.00	9006680018000
0.0728		49	80.00	53.00	9006680018500
0.0748			80.00	53.00	9006680019000
0.0760		48	85.00	56.00	9006680019300
0.0768			85.00	56.00	9006680019500
0.0780		5/64	85.00	56.00	9006680019800
0.0783		47	85.00	56.00	9006680019900
0.0787			85.00	56.00	9006680020000
0.0811		46	85.00	56.00	9006680020600
0.0819		45	85.00	56.00	9006680020800
0.0827			85.00	56.00	9006680021000
0.0858		44	90.00	59.00	9006680021800
0.0866			90.00	59.00	9006680022000
0.0886			90.00	59.00	9006680022500
0.0890		43	90.00	59.00	9006680022600
0.0906			90.00	59.00	9006680023000
0.0937		3/32	95.00	62.00	9006680023800
0.0945			95.00	62.00	9006680024000
0.0980		40	95.00	62.00	9006680024900
0.0984			95.00	62.00	9006680025000
0.0996		39	95.00	62.00	9006680025300
0.1016		38	95.00	62.00	9006680025800
0.1024			95.00	62.00	9006680026000
0.1039		37	95.00	62.00	9006680026400
0.1063			100.00	66.00	9006680027000
0.1067		36	100.00	66.00	9006680027100
0.1094		7/64	100.00	66.00	9006680027800
0.1102			100.00	66.00	9006680028000
0.1110		34	100.00	66.00	9006680028200
0.1130		33	100.00	66.00	9006680028700
0.1142			100.00	66.00	9006680029000
0.1161		32	100.00	66.00	9006680029500
0.1181			100.00	66.00	9006680030000
0.1201		31	106.00	69.00	9006680030500
0.1220			106.00	69.00	9006680031000
0.1248		1/8	106.00	69.00	9006680031700
0.1260			106.00	69.00	9006680032000
0.1299			106.00	69.00	9006680033000
0.1339			112.00	73.00	9006680034000

Dec. inch	Diameter (d1)		l1 mm	l2 mm	EDP #
	Fract. inch	Wire / letter			
0.1358		29	112.00	73.00	9006680034500
0.1378			112.00	73.00	9006680035000
0.1406		9/64	112.00	73.00	9006680035700
0.1417			112.00	73.00	9006680036000
0.1457			112.00	73.00	9006680037000
0.1469		26	112.00	73.00	9006680037300
0.1496		25	119.00	78.00	9006680038000
0.1520		24	119.00	78.00	9006680038600
0.1524			119.00	78.00	9006680038700
0.1535			119.00	78.00	9006680039000
0.1563		5/32	119.00	78.00	9006680039700
0.1575			119.00	78.00	9006680040000
0.1591		21	119.00	78.00	9006680040400
0.1610		20	119.00	78.00	9006680040900
0.1614			119.00	78.00	9006680041000
0.1654			119.00	78.00	9006680042000
0.1661		19	119.00	78.00	9006680042200
0.1693		18	126.00	82.00	9006680043000
0.1720		11/64	126.00	82.00	9006680043700
0.1732			126.00	82.00	9006680044000
0.1772		16	126.00	82.00	9006680045000
0.1811			126.00	82.00	9006680046000
0.1850		13	126.00	82.00	9006680047000
0.1874		3/16	132.00	87.00	9006680047600
0.1890		12	132.00	87.00	9006680048000
0.1909		11	132.00	87.00	9006680048500
0.1929			132.00	87.00	9006680049000
0.1933			132.00	87.00	9006680049100
0.1937		10	132.00	87.00	9006680049200
0.1969			132.00	87.00	9006680050000
0.1992		8	132.00	87.00	9006680050600
0.2008			132.00	87.00	9006680051000
0.2031		13/64	132.00	87.00	9006680051600
0.2047			132.00	87.00	9006680052000
0.2087			132.00	87.00	9006680053000
0.2091		4	139.00	91.00	9006680053100
0.2126			139.00	91.00	9006680054000
0.2165			139.00	91.00	9006680055000
0.2189		7/32	139.00	91.00	9006680055600
0.2205			139.00	91.00	9006680056000
0.2244			139.00	91.00	9006680057000
0.2283			139.00	91.00	9006680058000
0.2323			139.00	91.00	9006680059000
0.2343		15/64	139.00	91.00	9006680059500
0.2362			139.00	91.00	9006680060000
0.2378		B	148.00	97.00	9006680060400
0.2402			148.00	97.00	9006680061000
0.2421		C	148.00	97.00	9006680061500
0.2441			148.00	97.00	9006680062000
0.2461		D	148.00	97.00	9006680062500
0.2480			148.00	97.00	9006680063000
0.2500		1/4	148.00	97.00	9006680063500
0.2520			148.00	97.00	9006680064000
0.2559			148.00	97.00	9006680065000

Series 668

Speeds & Feeds information pg 452

Twist Drills

Dec. inch	Diameter (d1)		mm	l1 mm	l2 mm	EDP #
	Fract. inch	Wire / letter				
0.2571		F	6.530	148.00	97.00	9006680065300
0.2598			6.600	148.00	97.00	9006680066000
0.2638			6.700	148.00	97.00	9006680067000
0.2657	17/64	H	6.750	156.00	102.00	9006680067500
0.2677			6.800	156.00	102.00	9006680068000
0.2717		I	6.900	156.00	102.00	9006680069000
0.2756			7.000	156.00	102.00	9006680070000
0.2795			7.100	156.00	102.00	9006680071000
0.2811	9/32	K	7.140	156.00	102.00	9006680071400
0.2835			7.200	156.00	102.00	9006680072000
0.2854			7.250	156.00	102.00	9006680072500
0.2874			7.300	156.00	102.00	9006680073000
0.2913			7.400	156.00	102.00	9006680074000
0.2953			7.500	156.00	102.00	9006680075000
0.2992			7.600	165.00	109.00	9006680076000
0.3031			7.700	165.00	109.00	9006680077000
0.3071			7.800	165.00	109.00	9006680078000
0.3110			7.900	165.00	109.00	9006680079000
0.3126	5/16		7.940	165.00	109.00	9006680079400
0.3150			8.000	165.00	109.00	9006680080000
0.3189			8.100	165.00	109.00	9006680081000
0.3228		P	8.200	165.00	109.00	9006680082000
0.3268			8.300	165.00	109.00	9006680083000
0.3307			8.400	165.00	109.00	9006680084000
0.3319		Q	8.430	165.00	109.00	9006680084300
0.3346			8.500	165.00	109.00	9006680085000
0.3386			8.600	175.00	115.00	9006680086000
0.3390		R	8.610	175.00	115.00	9006680086100
0.3425			8.700	175.00	115.00	9006680087000
0.3437	11/32		8.730	175.00	115.00	9006680087300
0.3465			8.800	175.00	115.00	9006680088000
0.3504			8.900	175.00	115.00	9006680089000
0.3543			9.000	175.00	115.00	9006680090000
0.3583			9.100	175.00	115.00	9006680091000
0.3594	23/64		9.130	175.00	115.00	9006680091300

Dec. inch	Diameter (d1)		mm	l1 mm	l2 mm	EDP #
	Fract. inch	Wire / letter				
0.3661			9.300	175.00	115.00	9006680093000
0.3677		U	9.340	175.00	115.00	9006680093400
0.3701			9.400	175.00	115.00	9006680094000
0.3740			9.500	175.00	115.00	9006680095000
0.3748	3/8		9.520	184.00	121.00	9006680095200
0.3780			9.600	184.00	121.00	9006680096000
0.3819			9.700	184.00	121.00	9006680097000
0.3858		W	9.800	184.00	121.00	9006680098000
0.3898			9.900	184.00	121.00	9006680099000
0.3906	25/64		9.920	184.00	121.00	9006680099200
0.3937			10.000	184.00	121.00	9006680100000
0.4016			10.200	184.00	121.00	9006680102000
0.4063	13/32		10.320	184.00	121.00	9006680103200
0.4134			10.500	184.00	121.00	9006680105000
0.4220	27/64		10.720	195.00	128.00	9006680107200
0.4331			11.000	195.00	128.00	9006680110000
0.4374	7/16		11.110	195.00	128.00	9006680111100
0.4528			11.500	195.00	128.00	9006680115000
0.4531	29/64		11.510	195.00	128.00	9006680115100
0.4689	15/32		11.910	205.00	134.00	9006680119100
0.4724			12.000	205.00	134.00	9006680120000
0.4843	31/64		12.300	205.00	134.00	9006680123000
0.4921			12.500	205.00	134.00	9006680125000
0.5000	1/2		12.700	205.00	134.00	9006680127000
0.5118			13.000	205.00	134.00	9006680130000
0.5157	33/64		13.100	205.00	134.00	9006680131000
0.5512			14.000	214.00	140.00	9006680140000

Alternative Drill Series:

- #535 HSS, GT100, 10xD, 130 pt, Bright/Nitrided lands > 2.36
- #336 Cobalt, GT100, 10xD, 130 pt, Bright/Nitrided lands > 2.36

*Items listed in red are non-stocked items, and may take 2 - 6 weeks to receive

10xD



TiN Coated



External Coolant

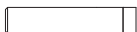

Straight Shank

Speeds & Feeds
information pg 452

Series 669

Type Ti

Cobalt, Type Ti, taper length, self-centering 130° split point,
web thinned all dia., standard straight shank, RH helix

Cut / Shank Dia. = h8 tolerance range

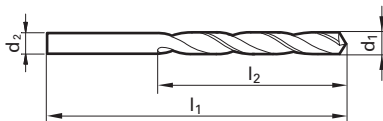
 $d_1 = d_2$

Application Materials:



Universal Steels



Stainless Steels



Hardened Materials



Ti & Ni Alloys

Dec. inch	Diameter (d1)		Wire / letter	l1 mm	l2 mm	EDP #
	Fract. inch	mm				
0.0394		1.000		56.00	33.00	9006690010000
0.0551		1.400	54	70.00	45.00	9006690014000
0.0591		1.500		70.00	45.00	9006690015000
0.0626	1/16	1.590		76.00	50.00	9006690015900
0.0630		1.600		76.00	50.00	9006690016000
0.0650		1.650		76.00	50.00	9006690016500
0.0669		1.700	51	76.00	50.00	9006690017000
0.0709		1.800		80.00	53.00	9006690018000
0.0748		1.900		80.00	53.00	9006690019000
0.0780	5/64	1.980		85.00	56.00	9006690019800
0.0787		2.000		85.00	56.00	9006690020000
0.0827		2.100		85.00	56.00	9006690021000
0.0866		2.200		90.00	59.00	9006690022000
0.0906		2.300		90.00	59.00	9006690023000
0.0937	3/32	2.380		95.00	62.00	9006690023800
0.0945		2.400		95.00	62.00	9006690024000
0.0984		2.500		95.00	62.00	9006690025000
0.1024		2.600		95.00	62.00	9006690026000
0.1063		2.700		100.00	66.00	9006690027000
0.1094	7/64	2.780		100.00	66.00	9006690027800
0.1102		2.800		100.00	66.00	9006690028000
0.1142		2.900		100.00	66.00	9006690029000
0.1181		3.000		100.00	66.00	9006690030000
0.1220		3.100		106.00	69.00	9006690031000
0.1248	1/8	3.170		106.00	69.00	9006690031700
0.1260		3.200		106.00	69.00	9006690032000
0.1280		3.250		106.00	69.00	9006690032500
0.1299		3.300		106.00	69.00	9006690033000
0.1339		3.400		112.00	73.00	9006690034000
0.1378		3.500		112.00	73.00	9006690035000
0.1406	9/64	3.570	28	112.00	73.00	9006690035700
0.1417		3.600		112.00	73.00	9006690036000
0.1457		3.700		112.00	73.00	9006690037000
0.1496		3.800	25	119.00	78.00	9006690038000
0.1535		3.900		119.00	78.00	9006690039000
0.1563	5/32	3.970		119.00	78.00	9006690039700
0.1575		4.000		119.00	78.00	9006690040000
0.1614		4.100		119.00	78.00	9006690041000
0.1654		4.200		119.00	78.00	9006690042000
0.1693		4.300	18	126.00	82.00	9006690043000
0.1732		4.400		126.00	82.00	9006690044000
0.1772		4.500	16	126.00	82.00	9006690045000
0.1850		4.700	13	126.00	82.00	9006690047000
0.1874	3/16	4.760		132.00	87.00	9006690047600
0.1890		4.800		132.00	87.00	9006690048000
0.1929		4.900	12	132.00	87.00	9006690049000
0.1969		5.000		132.00	87.00	9006690050000
0.2008		5.100		132.00	87.00	9006690051000
0.2031	13/64	5.160		132.00	87.00	9006690051600
0.2047		5.200		132.00	87.00	9006690052000

Dec. inch	Diameter (d1)		Wire / letter	l1 mm	l2 mm	EDP #
	Fract. inch	mm				
0.2087		5.300		132.00	87.00	9006690053000
0.2165		5.500		139.00	91.00	9006690055000
0.2189	7/32	5.560		139.00	91.00	9006690055600
0.2205		5.600		139.00	91.00	9006690056000
0.2244		5.700		139.00	91.00	9006690057000
0.2283		5.800		139.00	91.00	9006690058000
0.2323		5.900		139.00	91.00	9006690059000
0.2362		6.000		139.00	91.00	9006690060000
0.2402		6.100		148.00	97.00	9006690061000
0.2441		6.200		148.00	97.00	9006690062000
0.2480		6.300		148.00	97.00	9006690063000
0.2500	1/4	6.350	E	148.00	97.00	9006690063500
0.2520		6.400		148.00	97.00	9006690064000
0.2559		6.500		148.00	97.00	9006690065000
0.2598		6.600		148.00	97.00	9006690066000
0.2638		6.700		148.00	97.00	9006690067000
0.2657	17/64	6.750	H	156.00	102.00	9006690067500
0.2677		6.800		156.00	102.00	9006690068000
0.2717		6.900	I	156.00	102.00	9006690069000
0.2756		7.000		156.00	102.00	9006690070000
0.2795		7.100		156.00	102.00	9006690071000
0.2811	9/32	7.140	K	156.00	102.00	9006690071400
0.2874		7.300		156.00	102.00	9006690073000
0.2913		7.400		156.00	102.00	9006690074000
0.2953		7.500		156.00	102.00	9006690075000
0.2969	19/64	7.540		165.00	109.00	9006690075400
0.2992		7.600		165.00	109.00	9006690076000
0.3031		7.700		165.00	109.00	9006690077000
0.3071		7.800		165.00	109.00	9006690078000
0.3110		7.900		165.00	109.00	9006690079000
0.3126	5/16	7.940		165.00	109.00	9006690079400
0.3150		8.000		165.00	109.00	9006690080000
0.3228		8.200	P	165.00	109.00	9006690082000
0.3307		8.400		165.00	109.00	9006690084000
0.3346		8.500		165.00	109.00	9006690085000
0.3437	11/32	8.730		175.00	115.00	9006690087300
0.3543		9.000		175.00	115.00	9006690090000
0.3740		9.500		175.00	115.00	9006690095000
0.3748	3/8	9.520		184.00	121.00	9006690095200
0.3937		10.000		184.00	121.00	9006690100000

Alternative Drill Series:

#617 Cobalt, Ti, 10xD, 130 pt, Bright
 #336 Cobalt, GT100, 10xD, 130 pt, Bright/Nitrided lands > 2.36
 #535 HSS, GT100, 10xD, 130 pt, Bright/Nitrided lands > 2.36
 #668 HSS, GT100, 10xD, 130 pt, TiN

Extra Length #1



TiN coated



External Coolant



Straight Shank

Speeds & Feeds
information pg 453

Series 670

GT 100 Parabolic

HSS, GT 100 deep hole, extra length #1, 130° point, Form A web thinned all dia., standard straight shank, RH helix

Cut / Shank Dia. = h8 tolerance range

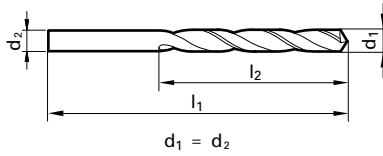

Application Materials:

- General Steels/Brass
- Aluminum & Alloys
- Universal Steels

Twist Drills

Dec. inch	Diameter (d1)		l1 mm	l2 mm	EDP #
	Fract. inch	Wire / letter			
0.0780	5/64		125.00	85.00	9006700019800
0.0787			125.00	85.00	9006700020000
0.0827			125.00	85.00	9006700021000
0.0866			135.00	90.00	9006700022000
0.0906			135.00	90.00	9006700023000
0.0937	3/32		150.00	100.00	9006700023800
0.0945			150.00	100.00	9006700024000
0.0984			150.00	100.00	9006700025000
0.1102			150.00	100.00	9006700028000
0.1161		32	150.00	100.00	9006700029500
0.1181			150.00	100.00	9006700030000
0.1220			155.00	105.00	9006700031000
0.1248	1/8		155.00	105.00	9006700031700
0.1260			155.00	105.00	9006700032000
0.1268			155.00	105.00	9006700032200
0.1299			155.00	105.00	9006700033000
0.1378			165.00	115.00	9006700035000
0.1406	9/64	28	165.00	115.00	9006700035700
0.1417			165.00	115.00	9006700036000
0.1496		25	175.00	120.00	9006700038000
0.1535			175.00	120.00	9006700039000
0.1539		23	175.00	120.00	9006700039100
0.1563	5/32		175.00	120.00	9006700039700
0.1575			175.00	120.00	9006700040000
0.1614			175.00	120.00	9006700041000
0.1654			175.00	120.00	9006700042000
0.1720	11/64		185.00	125.00	9006700043700
0.1772		16	185.00	125.00	9006700045000
0.1811			185.00	125.00	9006700046000
0.1874	3/16		195.00	135.00	9006700047600
0.1890		12	195.00	135.00	9006700048000
0.1969			195.00	135.00	9006700050000
0.2008			195.00	135.00	9006700051000
0.2031	13/64		195.00	135.00	9006700051600

Dec. inch	Diameter (d1)		l1 mm	l2 mm	EDP #
	Fract. inch	Wire / letter			
0.2047			195.00	135.00	9006700052000
0.2165			205.00	140.00	9006700055000
0.2189	7/32		205.00	140.00	9006700055600
0.2362			205.00	140.00	9006700060000
0.2402			215.00	150.00	9006700061000
0.2441			215.00	150.00	9006700062000
0.2500	1/4	E	215.00	150.00	9006700063500
0.2559			215.00	150.00	9006700065000
0.2638			215.00	150.00	9006700067000
0.2756			225.00	155.00	9006700070000
0.2811	9/32	K	225.00	155.00	9006700071400
0.2953			225.00	155.00	9006700075000
0.2969	19/64		240.00	165.00	9006700075400
0.3126	5/16		240.00	165.00	9006700079400
0.3150			240.00	165.00	9006700080000
0.3346			240.00	165.00	9006700085000
0.3386			250.00	175.00	9006700086000
0.3437	11/32		250.00	175.00	9006700087300
0.3465			250.00	175.00	9006700088000
0.3543			250.00	175.00	9006700090000
0.3740			250.00	175.00	9006700095000
0.3748	3/8		265.00	185.00	9006700095200
0.3906	25/64		265.00	185.00	9006700099200
0.3937			265.00	185.00	9006700100000
0.4331			280.00	195.00	9006700110000
0.4724			295.00	205.00	9006700120000
0.4921			295.00	205.00	9006700125000

Alternative Drill Series:

- #618 Cobalt, GT100, >10xD, 130 pt, Bright
- #502 HSS, GT100, >10xD, 130 pt, Bright
- #524 HSS, GT50, >10xD, 130 pt, Bright
- #235 HSS, GP, >10xD, 118 pt, Oxide

*Items listed in red are non-stocked items, and may take 2 - 6 weeks to receive

Extra Length

#2



TiN coated



External Coolant

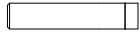

Straight Shank

Speeds & Feeds
information pg 453

Series 671

GT 100 Parabolic

HSS, GT 100 deep hole, extra length #2, 130° point, Form A
web thinned all dia., standard straight shank, RH helix

Cut / Shank Dia. = h8 tolerance range

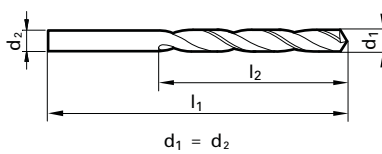

Application Materials:

-  General Steels/Brass
-  Aluminum & Alloys
-  Universal Steels

Dec. inch	Diameter (d1)			l1 mm	l2 mm	EDP #
	Fract. inch	Wire / letter	mm			
0.1181			3.000	190.00	130.00	9006710030000
0.1220			3.100	200.00	135.00	9006710031000
0.1248	1/8		3.170	200.00	135.00	9006710031700
0.1260			3.200	200.00	135.00	9006710032000
0.1339			3.400	210.00	145.00	9006710034000
0.1378			3.500	210.00	145.00	9006710035000
0.1406	9/64	28	3.570	210.00	145.00	9006710035700
0.1496		25	3.800	220.00	150.00	9006710038000
0.1563	5/32		3.970	220.00	150.00	9006710039700
0.1575			4.000	220.00	150.00	9006710040000
0.1610		20	4.090	220.00	150.00	9006710040900
0.1673			4.250	220.00	150.00	9006710042500
0.1720	11/64		4.370	235.00	160.00	9006710043700
0.1732			4.400	235.00	160.00	9006710044000
0.1772		16	4.500	235.00	160.00	9006710045000
0.1811			4.600	235.00	160.00	9006710046000
0.1874	3/16		4.760	245.00	170.00	9006710047600
0.1890		12	4.800	245.00	170.00	9006710048000
0.1969			5.000	245.00	170.00	9006710050000
0.2008			5.100	245.00	170.00	9006710051000

Dec. inch	Diameter (d1)			l1 mm	l2 mm	EDP #
	Fract. inch	Wire / letter	mm			
0.2087			5.300	245.00	170.00	9006710053000
0.2165			5.500	260.00	180.00	9006710055000
0.2189	7/32		5.560	260.00	180.00	9006710055600
0.2343	15/64		5.950	260.00	180.00	9006710059500
0.2362			6.000	260.00	180.00	9006710060000
0.2402			6.100	275.00	190.00	9006710061000
0.2500	1/4	E	6.350	275.00	190.00	9006710063500
0.2520			6.400	275.00	190.00	9006710064000
0.2559			6.500	275.00	190.00	9006710065000
0.2677			6.800	290.00	200.00	9006710068000
0.2756			7.000	290.00	200.00	9006710070000
0.2953			7.500	290.00	200.00	9006710075000
0.3126	5/16		7.940	305.00	210.00	9006710079400
0.3150			8.000	305.00	210.00	9006710080000

Alternative Drill Series:

- #503 HSS, GT100, >10xD, 130 pt, Bright
- #619 Cobalt, GT100, >10xD, 130 pt, Bright

3xD



Speeds & Feeds
information pg 454

Series 730

General Purpose

Carbide, general purpose (Type N), stub length, 118° faceted point, web thinned >2.0mm dia., standard straight shank, RH helix

Cut / Shank Dia. = h7 tolerance range

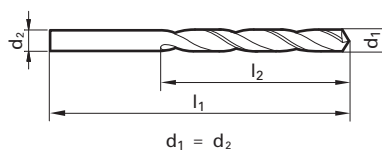

Application Materials:

- Universal Steels
- General Steels/Brass
- Cast Iron
- Aluminum & Alloys

Twist Drills



Diameter (d1)		Wire / letter	mm	l1 mm	l2 mm	EDP #
Dec. inch	Fract. inch					
0.0197			0.500	20.00	3.00	9007300005000
0.0236			0.600	21.00	3.50	9007300006000
0.0276			0.700	23.00	4.50	9007300007000
0.0315			0.800	24.00	5.00	9007300008000
0.0354			0.900	25.00	5.50	9007300009000
0.0394			1.000	26.00	6.00	9007300010000
0.0402		60	1.020	26.00	6.00	9007300010200
0.0409		59	1.040	26.00	6.00	9007300010400
0.0421		58	1.070	28.00	7.00	9007300010700
0.0429		57	1.090	28.00	7.00	9007300010900
0.0433			1.100	28.00	7.00	9007300011000
0.0465		56	1.180	28.00	7.00	9007300011800
0.0469	3/64		1.190	28.00	7.00	9007300011900
0.0472			1.200	28.00	7.00	9007300012000
0.0512			1.300	28.00	7.00	9007300013000
0.0520		55	1.320	30.00	8.00	9007300013200
0.0551		54	1.400	32.00	9.00	9007300014000
0.0591			1.500	32.00	9.00	9007300015000
0.0594		53	1.510	34.00	10.00	9007300015100
0.0626	1/16		1.590	34.00	10.00	9007300015900
0.0630			1.600	34.00	10.00	9007300016000
0.0634		52	1.610	34.00	10.00	9007300016100
0.0669		51	1.700	34.00	10.00	9007300017000
0.0701		50	1.780	36.00	11.00	9007300017800
0.0709			1.800	36.00	11.00	9007300018000
0.0728		49	1.850	36.00	11.00	9007300018500
0.0748			1.900	36.00	11.00	9007300019000
0.0760		48	1.930	38.00	12.00	9007300019300
0.0781	5/64		1.980	38.00	12.00	9007300019800
0.0783		47	1.990	38.00	12.00	9007300019900
0.0787			2.000	38.00	12.00	9007300020000
0.0811		46	2.060	38.00	12.00	9007300020600
0.0819		45	2.080	38.00	12.00	9007300020800
0.0827			2.100	38.00	12.00	9007300021000
0.0858		44	2.180	40.00	13.00	9007300021800
0.0866			2.200	40.00	13.00	9007300022000
0.0886			2.250	40.00	13.00	9007300022500
0.0890		43	2.260	40.00	13.00	9007300022600
0.0906			2.300	40.00	13.00	9007300023000
0.0933		42	2.370	43.00	14.00	9007300023700
0.0938	3/32		2.380	43.00	14.00	9007300023800
0.0945			2.400	43.00	14.00	9007300024000
0.0961		41	2.440	43.00	14.00	9007300024400
0.0980		40	2.490	43.00	14.00	9007300024900
0.0984			2.500	43.00	14.00	9007300025000
0.0996		39	2.530	43.00	14.00	9007300025300
0.1016		38	2.580	43.00	14.00	9007300025800
0.1024			2.600	43.00	14.00	9007300026000
0.1039		37	2.640	43.00	14.00	9007300026400
0.1063			2.700	46.00	16.00	9007300027000
0.1067		36	2.710	46.00	16.00	9007300027100
0.1094	7/64		2.780	46.00	16.00	9007300027800
0.1098		35	2.790	46.00	16.00	9007300027900
0.1102			2.800	46.00	16.00	9007300028000

Diameter (d1)		Wire / letter	mm	l1 mm	l2 mm	EDP #
Dec. inch	Fract. inch					
0.1110		34	2.820	46.00	16.00	9007300028200
0.1130		33	2.870	46.00	16.00	9007300028700
0.1142			2.900	46.00	16.00	9007300029000
0.1161		32	2.950	46.00	16.00	9007300029500
0.1181			3.000	46.00	16.00	9007300030000
0.1200			3.050	49.00	18.00	9007300030500
0.1220			3.100	49.00	18.00	9007300031000
0.1248	1/8		3.170	49.00	18.00	9007300031700
0.1260			3.200	49.00	18.00	9007300032000
0.1283		30	3.260	49.00	18.00	9007300032600
0.1299			3.300	49.00	18.00	9007300033000
0.1339			3.400	52.00	20.00	9007300034000
0.1360		29	3.450	52.00	20.00	9007300034500
0.1378			3.500	52.00	20.00	9007300035000
0.1406	9/64		3.570	52.00	20.00	9007300035700
0.1417			3.600	52.00	20.00	9007300036000
0.1441		27	3.660	52.00	20.00	9007300036600
0.1457			3.700	52.00	20.00	9007300037000
0.1469		26	3.730	52.00	20.00	9007300037300
0.1496		25	3.800	55.00	22.00	9007300038000
0.1520		24	3.860	55.00	22.00	9007300038600
0.1535			3.900	55.00	22.00	9007300039000
0.1539		23	3.910	55.00	22.00	9007300039100
0.1562	5/32		3.970	55.00	22.00	9007300039700
0.1571		22	3.990	55.00	22.00	9007300039900
0.1575			4.000	55.00	22.00	9007300040000
0.1591		21	4.040	55.00	22.00	9007300040400
0.1614			4.100	55.00	22.00	9007300041000
0.1654			4.200	55.00	22.00	9007300042000
0.1661		19	4.220	55.00	22.00	9007300042200
0.1693		18	4.300	58.00	24.00	9007300043000
0.1719	11/64		4.370	58.00	24.00	9007300043700
0.1730		17	4.390	58.00	24.00	9007300043900
0.1732			4.400	58.00	24.00	9007300044000
0.1772		16	4.500	58.00	24.00	9007300045000
0.1799		15	4.570	58.00	24.00	9007300045700
0.1811			4.600	58.00	24.00	9007300046000
0.1819		14	4.620	58.00	24.00	9007300046200
0.1850		13	4.700	58.00	24.00	9007300047000
0.1875	3/16		4.760	62.00	26.00	9007300047600
0.1890		12	4.800	62.00	26.00	9007300048000
0.1910		11	4.850	62.00	26.00	9007300048500
0.1929			4.900	62.00	26.00	9007300049000
0.1935		10	4.920	62.00	26.00	9007300049200
0.1961		9	4.980	62.00	26.00	9007300049800
0.1969			5.000	62.00	26.00	9007300050000
0.1992		8	5.060	62.00	26.00	9007300050600
0.2008			5.100	62.00	26.00	9007300051000
0.2012		7	5.110	62.00	26.00	9007300051100
0.2031	13/64		5.160	62.00	26.00	9007300051600
0.2039		6	5.180	62.00	26.00	9007300051800
0.2047			5.200	62.00	26.00	9007300052000
0.2055		5	5.220	62.00	26.00	9007300052200
0.2087			5.300	62.00	26.00	9007300053000

*Items listed in red are non-stocked items, and may take 2 - 6 weeks to receive

Series 730

Speeds & Feeds information pg 454

Dec. inch	Diameter (d1)		l1 mm	l2 mm	EDP #	
	Fract. inch	Wire / letter				
0.2091		4	5.310	66.00	28.00	9007300053100
0.2126			5.400	66.00	28.00	9007300054000
0.2130		3	5.410	66.00	28.00	9007300054100
0.2165			5.500	66.00	28.00	9007300055000
0.2188	7/32		5.560	66.00	28.00	9007300055600
0.2205			5.600	66.00	28.00	9007300056000
0.2205		2	5.610	66.00	28.00	9007300056200
0.2244			5.700	66.00	28.00	9007300057000
0.2280		1	5.790	66.00	28.00	9007300057900
0.2283			5.800	66.00	28.00	9007300058000
0.2323			5.900	66.00	28.00	9007300059000
0.2338			5.940	66.00	28.00	9007300059400
0.2344	15/64		5.950	66.00	28.00	9007300059500
0.2362			6.000	66.00	28.00	9007300060000
0.2377			6.040	70.00	31.00	9007300060400
0.2402			6.100	70.00	31.00	9007300061000
0.2421		C	6.150	70.00	31.00	9007300061500
0.2441			6.200	70.00	31.00	9007300062000
0.2461		D	6.250	70.00	31.00	9007300062500
0.2480			6.300	70.00	31.00	9007300063000
0.2500	1/4	E	6.350	70.00	31.00	9007300063500
0.2520			6.400	70.00	31.00	9007300064000
0.2559			6.500	70.00	31.00	9007300065000
0.2570		F	6.530	70.00	31.00	9007300065300
0.2598			6.600	70.00	31.00	9007300066000
0.2610		G	6.630	70.00	31.00	9007300066300
0.2638			6.700	74.00	34.00	9007300067000
0.2657	17/64	H	6.750	74.00	34.00	9007300067500
0.2677			6.800	74.00	34.00	9007300068000
0.2717		I	6.900	74.00	34.00	9007300069000
0.2756			7.000	74.00	34.00	9007300070000
0.2768		J	7.030	74.00	34.00	9007300070300
0.2795			7.100	74.00	34.00	9007300071000
0.2812	9/32	K	7.140	74.00	34.00	9007300071400
0.2835			7.200	74.00	34.00	9007300072000
0.2874			7.300	74.00	34.00	9007300073000
0.2902		L	7.370	74.00	34.00	9007300073700
0.2913			7.400	74.00	34.00	9007300074000
0.2949		M	7.490	74.00	34.00	9007300074900
0.2953			7.500	74.00	34.00	9007300075000
0.2969	19/64		7.540	79.00	37.00	9007300075400
0.2992			7.600	79.00	37.00	9007300076000
0.3019			7.670	79.00	37.00	9007300076700
0.3031			7.700	79.00	37.00	9007300077000
0.3071			7.800	79.00	37.00	9007300078000
0.3110			7.900	79.00	37.00	9007300079000
0.3126	5/16		7.940	79.00	37.00	9007300079400
0.3150			8.000	79.00	37.00	9007300080000
0.3161		O	8.030	79.00	37.00	9007300080300
0.3189			8.100	79.00	37.00	9007300081000
0.3228		P	8.200	79.00	37.00	9007300082000
0.3268			8.300	79.00	37.00	9007300083000
0.3281	21/64		8.330	79.00	37.00	9007300083300
0.3307			8.400	79.00	37.00	9007300084000
0.3319		Q	8.430	79.00	37.00	9007300084300

Dec. inch	Diameter (d1)		l1 mm	l2 mm	EDP #	
	Fract. inch	Wire / letter				
0.3346			8.500	79.00	37.00	9007300085000
0.3386			8.600	84.00	40.00	9007300086000
0.3390		R	8.610	84.00	40.00	9007300086100
0.3425			8.700	84.00	40.00	9007300087000
0.3438	11/32		8.730	84.00	40.00	9007300087300
0.3465			8.800	84.00	40.00	9007300088000
0.3480		S	8.840	84.00	40.00	9007300088400
0.3504			8.900	84.00	40.00	9007300089000
0.3543			9.000	84.00	40.00	9007300090000
0.3578			9.090	84.00	40.00	9007300090900
0.3583			9.100	84.00	40.00	9007300091000
0.3594	23/64		9.130	84.00	40.00	9007300091300
0.3622			9.200	84.00	40.00	9007300092000
0.3661			9.300	84.00	40.00	9007300093000
0.3677		U	9.340	84.00	40.00	9007300093400
0.3701			9.400	84.00	40.00	9007300094000
0.3740			9.500	84.00	40.00	9007300095000
0.3748	3/8		9.520	89.00	43.00	9007300095200
0.3772		V	9.580	89.00	43.00	9007300095800
0.3780			9.600	89.00	43.00	9007300096000
0.3819			9.700	89.00	43.00	9007300097000
0.3858		W	9.800	89.00	43.00	9007300098000
0.3898			9.900	89.00	43.00	9007300099000
0.3906	25/64		9.920	89.00	43.00	9007300099200
0.3937			10.000	89.00	43.00	9007300100000
0.3969		X	10.080	89.00	43.00	9007300100800
0.4016			10.200	89.00	43.00	9007300102000
0.4039		Y	10.260	89.00	43.00	9007300102600
0.4055			10.300	89.00	43.00	9007300103000
0.4063	13/32		10.320	89.00	43.00	9007300103200
0.4130		Z	10.490	89.00	43.00	9007300104900
0.4134			10.500	89.00	43.00	9007300105000
0.4220	27/64		10.720	95.00	47.00	9007300107200
0.4331			11.000	95.00	47.00	9007300110000
0.4375	7/16		11.110	95.00	47.00	9007300111100
0.4528			11.500	95.00	47.00	9007300115000
0.4531	29/64		11.510	95.00	47.00	9007300115100
0.4688	15/32		11.910	102.00	51.00	9007300119100
0.4724			12.000	102.00	51.00	9007300120000
0.4844	31/64		12.300	102.00	51.00	9007300123000
0.5000	1/2		12.700	102.00	51.00	9007300127000
0.5118			13.000	102.00	51.00	9007300130000
0.5311	17/32		13.490	107.00	54.00	9007300134900
0.5512			14.000	107.00	54.00	9007300140000
0.5626	9/16		14.290	111.00	56.00	9007300142900
0.5906			15.000	111.00	56.00	9007300150000
0.6248	5/8		15.870	115.00	58.00	9007300158700
0.6299			16.000	115.00	58.00	9007300160000

Alternative Drill Series:

- #2463 Carbide, GP, 3xD, 118 pt, FIREX®
- #5521 PM Cobalt, GT500, 3xD, 130 pt, TiN
- #515 PM Cobalt, GT500, 3xD, 130 pt, FIREX®
- #329 Cobalt, GV120, 3xD, 130 pt, Bright/Steam Oxide > 2.36

5xD

Series 732

Application Materials:

Twist Drills



Bright finish



External Coolant



Straight Shank

General Purpose

Carbide, general purpose (Type N), jobber length, 118° faceted point, web thinned >2.0mm dia., standard straight shank, RH helix

Cut / Shank Dia. = h7 tolerance range

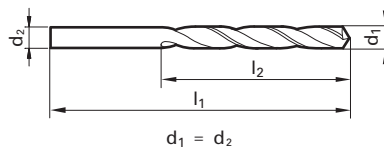

- Universal Steels
- General Steels/ Brass
- Cast Iron
- Aluminum & Alloys



Speeds & Feeds
information pg 454

Dec. inch	Diameter (d1)			l1 mm	l2 mm	EDP #
	Fract. inch	Wire / letter	mm			
0.0394			1.000	34.00	12.00	9007320010000
0.0402		60	1.020	34.00	12.00	9007320010200
0.0409		59	1.040	34.00	12.00	9007320010400
0.0421		58	1.070	36.00	14.00	9007320010700
0.0429		57	1.090	36.00	14.00	9007320010900
0.0433			1.100	36.00	14.00	9007320011000
0.0465		56	1.180	36.00	14.00	9007320011800
0.0469		3/64	1.190	38.00	16.00	9007320011900
0.0472			1.200	38.00	16.00	9007320012000
0.0512			1.300	38.00	16.00	9007320013000
0.0520		55	1.320	38.00	16.00	9007320013200
0.0551		54	1.400	40.00	18.00	9007320014000
0.0591			1.500	40.00	18.00	9007320015000
0.0594		53	1.510	40.00	18.00	9007320015100
0.0626		1/16	1.590	40.00	18.00	9007320015900
0.0630			1.600	43.00	20.00	9007320016000
0.0634		52	1.610	43.00	20.00	9007320016100
0.0669		51	1.700	43.00	20.00	9007320017000
0.0701		50	1.780	46.00	22.00	9007320017800
0.0709			1.800	46.00	22.00	9007320018000
0.0728		49	1.850	46.00	22.00	9007320018500
0.0748			1.900	46.00	22.00	9007320019000
0.0760		48	1.930	49.00	24.00	9007320019300
0.0780		5/64	1.980	49.00	24.00	9007320019800
0.0783			1.990	49.00	24.00	9007320019900
0.0787			2.000	49.00	24.00	9007320020000
0.0811		46	2.060	49.00	24.00	9007320020600
0.0819		45	2.080	49.00	24.00	9007320020800
0.0827			2.100	49.00	24.00	9007320021000
0.0858		44	2.180	53.00	27.00	9007320021800
0.0866			2.200	53.00	27.00	9007320022000
0.0890		43	2.260	53.00	27.00	9007320022600
0.0906			2.300	53.00	27.00	9007320023000
0.0933		42	2.370	57.00	30.00	9007320023700
0.0937		3/32	2.380	57.00	30.00	9007320023800
0.0945			2.400	57.00	30.00	9007320024000
0.0961		41	2.440	57.00	30.00	9007320024400
0.0980		40	2.490	57.00	30.00	9007320024900
0.0984			2.500	57.00	30.00	9007320025000
0.0996		39	2.530	57.00	30.00	9007320025300
0.1016		38	2.580	57.00	30.00	9007320025800
0.1024			2.600	57.00	30.00	9007320026000
0.1039		37	2.640	57.00	30.00	9007320026400
0.1063			2.700	61.00	33.00	9007320027000
0.1067		36	2.710	61.00	33.00	9007320027100
0.1094		7/64	2.780	61.00	33.00	9007320027800
0.1098		35	2.790	61.00	33.00	9007320027900
0.1102			2.800	61.00	33.00	9007320028000
0.1110		34	2.820	61.00	33.00	9007320028200
0.1130		33	2.870	61.00	33.00	9007320028700
0.1142			2.900	61.00	33.00	9007320029000
0.1161		32	2.950	61.00	33.00	9007320029500
0.1181			3.000	61.00	33.00	9007320030000
0.1201		31	3.050	65.00	36.00	9007320030500

Dec. inch	Diameter (d1)			l1 mm	l2 mm	EDP #
	Fract. inch	Wire / letter	mm			
0.1220			3.100	65.00	36.00	9007320031000
0.1248		1/8	3.170	65.00	36.00	9007320031700
0.1260			3.200	65.00	36.00	9007320032000
0.1283		30	3.260	65.00	36.00	9007320032600
0.1299			3.300	65.00	36.00	9007320033000
0.1339			3.400	70.00	39.00	9007320034000
0.1358		29	3.450	70.00	39.00	9007320034500
0.1378			3.500	70.00	39.00	9007320035000
0.1406		9/64	3.570	70.00	39.00	9007320035700
0.1417			3.600	70.00	39.00	9007320036000
0.1441		27	3.660	70.00	39.00	9007320036600
0.1457			3.700	70.00	39.00	9007320037000
0.1469		26	3.730	70.00	39.00	9007320037300
0.1496		25	3.800	75.00	43.00	9007320038000
0.1520		24	3.860	75.00	43.00	9007320038600
0.1535			3.900	75.00	43.00	9007320039000
0.1539		23	3.910	75.00	43.00	9007320039100
0.1562		5/32	3.970	75.00	43.00	9007320039700
0.1571			3.990	75.00	43.00	9007320039900
0.1575			4.000	75.00	43.00	9007320040000
0.1591		21	4.040	75.00	43.00	9007320040400
0.1610		20	4.090	75.00	43.00	9007320040900
0.1614			4.100	75.00	43.00	9007320041000
0.1654			4.200	75.00	43.00	9007320042000
0.1661		19	4.220	75.00	43.00	9007320042200
0.1693		18	4.300	80.00	47.00	9007320043000
0.1720		11/64	4.370	80.00	47.00	9007320043700
0.1728		17	4.390	80.00	47.00	9007320043900
0.1732			4.400	80.00	47.00	9007320044000
0.1772		16	4.500	80.00	47.00	9007320045000
0.1799		15	4.570	80.00	47.00	9007320045700
0.1811			4.600	80.00	47.00	9007320046000
0.1819		14	4.620	80.00	47.00	9007320046200
0.1850		13	4.700	80.00	47.00	9007320047000
0.1874		3/16	4.760	86.00	52.00	9007320047600
0.1890		12	4.800	86.00	52.00	9007320048000
0.1909		11	4.850	86.00	52.00	9007320048500
0.1929			4.900	86.00	52.00	9007320049000
0.1937		10	4.920	86.00	52.00	9007320049200
0.1961		9	4.980	86.00	52.00	9007320049800
0.1969			5.000	86.00	52.00	9007320050000
0.1992		8	5.060	86.00	52.00	9007320050600
0.2008			5.100	86.00	52.00	9007320051000
0.2012		7	5.110	86.00	52.00	9007320051100
0.2031		13/64	5.160	86.00	52.00	9007320051600
0.2039		6	5.180	86.00	52.00	9007320051800
0.2047			5.200	86.00	52.00	9007320052000
0.2055		5	5.220	86.00	52.00	9007320052200
0.2087			5.300	86.00	52.00	9007320053000
0.2091		4	5.310	93.00	57.00	9007320053100
0.2126			5.400	93.00	57.00	9007320054000
0.2130		3	5.410	93.00	57.00	9007320054100
0.2165			5.500	93.00	57.00	9007320055000
0.2189		7/32	5.560	93.00	57.00	9007320055600

*Items listed in red are non-stocked items, and may take 2 - 6 weeks to receive

Series 732

Speeds & Feeds information pg 454

Twist Drills

Diameter (d1)		Wire / letter	l1 mm	l2 mm	EDP #	
Dec. inch	Fract. inch					
0.2205			5.600	93.00	57.00	9007320056000
0.2209		2	5.610	93.00	57.00	9007320056100
0.2244			5.700	93.00	57.00	9007320057000
0.2280		1	5.790	93.00	57.00	9007320057900
0.2283			5.800	93.00	57.00	9007320058000
0.2323			5.900	93.00	57.00	9007320059000
0.2339		A	5.940	93.00	57.00	9007320059400
0.2343	15/64		5.950	93.00	57.00	9007320059500
0.2362			6.000	93.00	57.00	9007320060000
0.2378		B	6.040	101.00	63.00	9007320060400
0.2402			6.100	101.00	63.00	9007320061000
0.2421		C	6.150	101.00	63.00	9007320061500
0.2441			6.200	101.00	63.00	9007320062000
0.2461		D	6.250	101.00	63.00	9007320062500
0.2480			6.300	101.00	63.00	9007320063000
0.2500	1/4	E	6.350	101.00	63.00	9007320063500
0.2520			6.400	101.00	63.00	9007320064000
0.2559			6.500	101.00	63.00	9007320065000
0.2571		F	6.530	101.00	63.00	9007320065300
0.2598			6.600	101.00	63.00	9007320066000
0.2610		G	6.630	101.00	63.00	9007320066300
0.2638			6.700	101.00	63.00	9007320067000
0.2657	17/64	H	6.750	109.00	69.00	9007320067500
0.2677			6.800	109.00	69.00	9007320068000
0.2717		I	6.900	109.00	69.00	9007320069000
0.2756			7.000	109.00	69.00	9007320070000
0.2768		J	7.030	109.00	69.00	9007320070300
0.2795			7.100	109.00	69.00	9007320071000
0.2811	9/32	K	7.140	109.00	69.00	9007320071400
0.2835			7.200	109.00	69.00	9007320072000
0.2874			7.300	109.00	69.00	9007320073000
0.2902		L	7.370	109.00	69.00	9007320073700
0.2913			7.400	109.00	69.00	9007320074000
0.2949		M	7.490	109.00	69.00	9007320074900
0.2953			7.500	109.00	69.00	9007320075000
0.2969	19/64		7.540	117.00	75.00	9007320075400
0.2992			7.600	117.00	75.00	9007320076000
0.3020		N	7.670	117.00	75.00	9007320076700
0.3031			7.700	117.00	75.00	9007320077000
0.3071			7.800	117.00	75.00	9007320078000
0.3110			7.900	117.00	75.00	9007320079000
0.3126	5/16		7.940	117.00	75.00	9007320079400
0.3150			8.000	117.00	75.00	9007320080000
0.3161		O	8.030	117.00	75.00	9007320080300
0.3189			8.100	117.00	75.00	9007320081000
0.3228		P	8.200	117.00	75.00	9007320082000
0.3268			8.300	117.00	75.00	9007320083000
0.3280	21/64		8.330	117.00	75.00	9007320083300
0.3307			8.400	117.00	75.00	9007320084000
0.3319		Q	8.430	117.00	75.00	9007320084300

Diameter (d1)		Wire / letter	l1 mm	l2 mm	EDP #	
Dec. inch	Fract. inch					
0.3346			8.500	117.00	75.00	9007320085000
0.3386			8.600	125.00	81.00	9007320086000
0.3390		R	8.610	125.00	81.00	9007320086100
0.3425			8.700	125.00	81.00	9007320087000
0.3437	11/32		8.730	125.00	81.00	9007320087300
0.3465			8.800	125.00	81.00	9007320088000
0.3480		S	8.840	125.00	81.00	9007320088400
0.3504			8.900	125.00	81.00	9007320089000
0.3543			9.000	125.00	81.00	9007320090000
0.3579		T	9.090	125.00	81.00	9007320090900
0.3583			9.100	125.00	81.00	9007320091000
0.3594	23/64		9.130	125.00	81.00	9007320091300
0.3622			9.200	125.00	81.00	9007320092000
0.3661			9.300	125.00	81.00	9007320093000
0.3677		U	9.340	125.00	81.00	9007320093400
0.3701			9.400	125.00	81.00	9007320094000
0.3740			9.500	125.00	81.00	9007320095000
0.3748	3/8		9.520	133.00	87.00	9007320095200
0.3772		V	9.580	133.00	87.00	9007320095800
0.3780			9.600	133.00	87.00	9007320096000
0.3819			9.700	133.00	87.00	9007320097000
0.3858		W	9.800	133.00	87.00	9007320098000
0.3898			9.900	133.00	87.00	9007320099000
0.3906	25/64		9.920	133.00	87.00	9007320099200
0.3937			10.000	133.00	87.00	9007320100000
0.3969		X	10.080	133.00	87.00	9007320100800
0.4016			10.200	133.00	87.00	9007320102000
0.4039		Y	10.260	133.00	87.00	9007320102600
0.4055			10.300	133.00	87.00	9007320103000
0.4062	13/32		10.320	133.00	87.00	9007320103200
0.4130		Z	10.490	133.00	87.00	9007320104900
0.4134			10.500	133.00	87.00	9007320105000
0.4220	27/64		10.720	142.00	94.00	9007320107200
0.4331			11.000	142.00	94.00	9007320110000
0.4375	7/16		11.110	142.00	94.00	9007320111100
0.4528			11.500	142.00	94.00	9007320115000
0.4531	29/64		11.510	142.00	94.00	9007320115100
0.4688	15/32		11.910	151.00	101.00	9007320119100
0.4724			12.000	151.00	101.00	9007320120000
0.4843	31/64		12.300	151.00	101.00	9007320123000
0.5000	1/2		12.700	151.00	101.00	9007320127000

Alternative Drill Series:

- #2464 Carbide, GP, 118 pt, FIREX®
- #2601 Carbide, GT100, 130 pt, Bright
- #2602 Carbide, GT100, 130 pt, TiN

4xD

Series 768

Application Materials:



Bright finish



Aluminum & Alloys



Cast Iron

Twist Drills

RT 150 GG

Carbide, RT 150 GG straight flute high penetration, 4xD, 120° point, Special web thinned all dia., reinforced straight shank, RH cut



Coolant Through

Cut Dia. = m7 tolerance range, Shank Dia. = h6



$$t_{max} = l_2 - 1,5 \times d_1$$

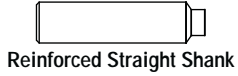
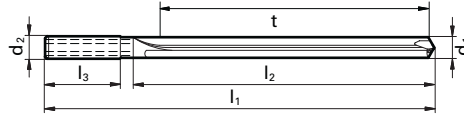

Reinforced Straight Shank

Speeds & Feeds information pg 455

Diameter (d1)		d2	l1	l2	EDP #
Dec. inch	Fract. inch Wire / letter				
0.1181		3.000	66.00	24.00	9007680030000
0.1220		3.100	66.00	24.00	9007680031000
0.1260		3.200	66.00	24.00	9007680032000
0.1299		3.300	66.00	24.00	9007680033000
0.1339		3.400	66.00	24.00	9007680034000
0.1378		3.500	66.00	24.00	9007680035000
0.1417		3.600	66.00	24.00	9007680036000
0.1457		3.700	66.00	24.00	9007680037000
0.1496	25	3.800	74.00	30.00	9007680038000
0.1535		3.900	74.00	30.00	9007680039000
0.1575		4.000	74.00	30.00	9007680040000
0.1614		4.100	74.00	30.00	9007680041000
0.1654		4.200	74.00	30.00	9007680042000
0.1693	18	4.300	74.00	30.00	9007680043000
0.1732		4.400	74.00	30.00	9007680044000
0.1772	16	4.500	74.00	30.00	9007680045000
0.1811		4.600	74.00	30.00	9007680046000
0.1850	13	4.700	74.00	30.00	9007680047000
0.1890	12	4.800	74.00	36.00	9007680048000
0.1929		4.900	74.00	36.00	9007680049000
0.1969		5.000	74.00	36.00	9007680050000
0.2008		5.100	74.00	36.00	9007680051000
0.2031	13/64	5.160	74.00	36.00	9007680051600
0.2047		5.200	74.00	36.00	9007680052000
0.2087		5.300	74.00	36.00	9007680053000
0.2126		5.400	74.00	36.00	9007680054000
0.2165		5.500	74.00	36.00	9007680055000
0.2189	7/32	5.560	74.00	36.00	9007680055600
0.2205		5.600	74.00	36.00	9007680056000
0.2244		5.700	74.00	36.00	9007680057000
0.2283		5.800	74.00	36.00	9007680058000
0.2323		5.900	74.00	36.00	9007680059000
0.2343	15/64	5.950	74.00	36.00	9007680059500
0.2362		6.000	74.00	36.00	9007680060000
0.2402		6.100	80.00	53.00	9007680061000
0.2441		6.200	80.00	53.00	9007680062000
0.2480		6.300	80.00	53.00	9007680063000
0.2500	1/4 E	6.350	80.00	53.00	9007680063500
0.2520		6.400	80.00	53.00	9007680064000
0.2559		6.500	80.00	53.00	9007680065000
0.2598		6.600	80.00	53.00	9007680066000
0.2638		6.700	80.00	53.00	9007680067000
0.2657	17/64 H	6.750	80.00	53.00	9007680067500
0.2677		6.800	80.00	53.00	9007680068000
0.2717	I	6.900	80.00	53.00	9007680069000
0.2756		7.000	80.00	53.00	9007680070000
0.2795		7.100	80.00	53.00	9007680071000
0.2811	9/32 K	7.140	80.00	53.00	9007680071400
0.2835		7.200	80.00	53.00	9007680072000
0.2874		7.300	80.00	53.00	9007680073000
0.2913		7.400	80.00	53.00	9007680074000
0.2953		7.500	80.00	53.00	9007680075000
0.2969	19/64	7.540	80.00	53.00	9007680075400
0.2992		7.600	80.00	53.00	9007680076000
0.3031		7.700	80.00	53.00	9007680077000
0.3071		7.800	80.00	53.00	9007680078000
0.3110		7.900	80.00	53.00	9007680079000

Diameter (d1)		d2	l1	l2	EDP #
Dec. inch	Fract. inch Wire / letter				
0.3126	5/16	7.940	91.00	53.00	9007680079400
0.3150		8.000	91.00	53.00	9007680080000
0.3189		8.100	103.00	61.00	9007680081000
0.3228	P	8.200	103.00	61.00	9007680082000
0.3268		8.300	103.00	61.00	9007680083000
0.3280	21/64	8.330	103.00	61.00	9007680083300
0.3307		8.400	103.00	61.00	9007680084000
0.3346		8.500	103.00	61.00	9007680085000
0.3386		8.600	103.00	61.00	9007680086000
0.3425		8.700	103.00	61.00	9007680087000
0.3437	11/32	8.730	103.00	61.00	9007680087300
0.3465		8.800	103.00	61.00	9007680088000
0.3504		8.900	103.00	61.00	9007680089000
0.3543		9.000	103.00	61.00	9007680090000
0.3583		9.100	103.00	61.00	9007680091000
0.3594	23/64	9.130	103.00	61.00	9007680091300
0.3622		9.200	103.00	61.00	9007680092000
0.3661		9.300	103.00	61.00	9007680093000
0.3701		9.400	103.00	61.00	9007680094000
0.3740		9.500	103.00	61.00	9007680095000
0.3748	3/8	9.520	103.00	61.00	9007680095200
0.3780		9.600	103.00	61.00	9007680096000
0.3819		9.700	103.00	61.00	9007680097000
0.3858	W	9.800	103.00	61.00	9007680098000
0.3898		9.900	103.00	61.00	9007680099000
0.3906	25/64	9.920	103.00	61.00	9007680099200
0.3937		10.000	103.00	61.00	9007680100000
0.4016		10.200	118.00	71.00	9007680102000
0.4063	13/32	10.320	118.00	71.00	9007680103200
0.4134		10.500	118.00	71.00	9007680105000
0.4220	27/64	10.720	118.00	71.00	9007680107200
0.4331		11.000	118.00	71.00	9007680110000
0.4374	7/16	11.110	118.00	71.00	9007680111100
0.4409		11.200	118.00	71.00	9007680112000
0.4528		11.500	118.00	71.00	9007680115000
0.4531	29/64	11.510	118.00	71.00	9007680115100
0.4689	15/32	11.910	118.00	71.00	9007680119100
0.4724		12.000	118.00	71.00	9007680120000
0.4843	31/64	12.300	124.00	74.00	9007680123000
0.4921		12.500	124.00	74.00	9007680125000
0.5000	1/2	12.700	124.00	74.00	9007680127000
0.5118		13.000	124.00	74.00	9007680130000
0.5315		13.500	124.00	74.00	9007680135000
0.5512		14.000	124.00	74.00	9007680140000
0.5709		14.500	133.00	83.00	9007680145000
0.5906		15.000	133.00	83.00	9007680150000
0.6102		15.500	133.00	83.00	9007680155000
0.6299		16.000	133.00	83.00	9007680160000
0.6496		16.500	143.00	93.00	9007680165000
0.6693		17.000	143.00	93.00	9007680170000
0.6890		17.500	143.00	93.00	9007680175000
0.7087		18.000	143.00	93.00	9007680180000
0.7283		18.500	153.00	101.00	9007680185000
0.7480		19.000	153.00	101.00	9007680190000
0.7677		19.500	153.00	101.00	9007680195000
0.7874		20.000	153.00	101.00	9007680200000

7xD



Bright finish

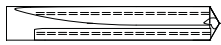

Coolant Through



Reinforced Straight Shank

Speeds & Feeds
information pg 455

Series 769

RT 150 GG

Carbide, RT 150 GG straight flute high penetration, 7xD, 120° point, Special web thinned all dia., reinforced straight shank, RH cut

Cut Dia. = m7 tolerance range, Shank Dia. = h6

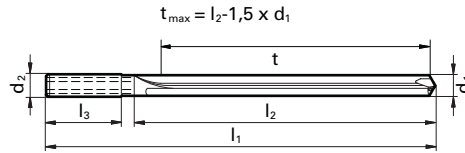

Application Materials:



Aluminum & Alloys



Cast Iron

Dec. inch	Diameter (d1)			d2 mm	l1 mm	l2 mm	EDP #
	Fract. inch	Wire / letter	mm				
0.1181			3.000	6.000	74.00	36.00	9007690030000
0.1220			3.100	6.000	74.00	36.00	9007690031000
0.1260			3.200	6.000	74.00	36.00	9007690032000
0.1299			3.300	6.000	74.00	36.00	9007690033000
0.1339			3.400	6.000	74.00	36.00	9007690034000
0.1378			3.500	6.000	74.00	36.00	9007690035000
0.1417			3.600	6.000	74.00	36.00	9007690036000
0.1457			3.700	6.000	74.00	36.00	9007690037000
0.1496		25	3.800	6.000	97.00	45.00	9007690038000
0.1535			3.900	6.000	97.00	45.00	9007690039000
0.1575			4.000	6.000	97.00	45.00	9007690040000
0.1614			4.100	6.000	97.00	45.00	9007690041000
0.1654			4.200	6.000	97.00	45.00	9007690042000
0.1693		18	4.300	6.000	97.00	45.00	9007690043000
0.1732			4.400	6.000	97.00	45.00	9007690044000
0.1772		16	4.500	6.000	97.00	45.00	9007690045000
0.1850		13	4.700	6.000	97.00	45.00	9007690047000
0.1890		12	4.800	6.000	97.00	57.00	9007690048000
0.1929			4.900	6.000	97.00	57.00	9007690049000
0.1969			5.000	6.000	97.00	57.00	9007690050000
0.2031	13/64		5.160	6.000	97.00	57.00	9007690051600
0.2165			5.500	6.000	97.00	57.00	9007690055000
0.2362			6.000	6.000	97.00	57.00	9007690060000
0.2500	1/4	E	6.350	8.000	116.00	76.00	9007690063500
0.2559			6.500	8.000	116.00	76.00	9007690065000
0.2677			6.800	8.000	116.00	76.00	9007690068000
0.2756			7.000	8.000	116.00	76.00	9007690070000
0.2811	9/32	K	7.140	8.000	116.00	76.00	9007690071400
0.2953			7.500	8.000	116.00	76.00	9007690075000
0.3071			7.800	8.000	116.00	76.00	9007690078000
0.3126	5/16		7.940	8.000	116.00	76.00	9007690079400
0.3150			8.000	8.000	116.00	76.00	9007690080000
0.3280	21/64		8.330	10.000	139.00	95.00	9007690083300
0.3346			8.500	10.000	139.00	95.00	9007690085000
0.3437	11/32		8.730	10.000	139.00	95.00	9007690087300
0.3543			9.000	10.000	139.00	95.00	9007690090000
0.3594	23/64		9.130	10.000	139.00	95.00	9007690091300

Dec. inch	Diameter (d1)			d2 mm	l1 mm	l2 mm	EDP #
	Fract. inch	Wire / letter	mm				
0.3740			9.500	10.000	139.00	95.00	9007690095000
0.3748	3/8		9.520	10.000	139.00	95.00	9007690095200
0.3937			10.000	10.000	139.00	95.00	9007690100000
0.4016			10.200	12.000	163.00	114.00	9007690102000
0.4063	13/32		10.320	12.000	163.00	114.00	9007690103200
0.4134			10.500	12.000	163.00	114.00	9007690105000
0.4220	27/64		10.720	12.000	163.00	114.00	9007690107200
0.4331			11.000	12.000	163.00	114.00	9007690110000
0.4374	7/16		11.110	12.000	163.00	114.00	9007690111100
0.4528			11.500	12.000	163.00	114.00	9007690115000
0.4531	29/64		11.510	12.000	163.00	114.00	9007690115100
0.4724			12.000	12.000	163.00	114.00	9007690120000
0.4843	31/64		12.300	14.000	182.00	133.00	9007690123000
0.4921			12.500	14.000	182.00	133.00	9007690125000
0.5000	1/2		12.700	14.000	182.00	133.00	9007690127000
0.5118			13.000	14.000	182.00	133.00	9007690130000
0.5315			13.500	14.000	182.00	133.00	9007690135000
0.5512			14.000	14.000	182.00	133.00	9007690140000
0.5709			14.500	16.000	204.00	152.00	9007690145000
0.5906			15.000	16.000	204.00	152.00	9007690150000
0.6102			15.500	16.000	204.00	152.00	9007690155000
0.6299			16.000	16.000	204.00	152.00	9007690160000
0.6496			16.500	18.000	223.00	171.00	9007690165000
0.6693			17.000	18.000	223.00	171.00	9007690170000
0.6890			17.500	18.000	223.00	171.00	9007690175000
0.7087			18.000	18.000	223.00	171.00	9007690180000
0.7283			18.500	20.000	244.00	190.00	9007690185000
0.7480			19.000	20.000	244.00	190.00	9007690190000
0.7677			19.500	20.000	244.00	190.00	9007690195000
0.7874			20.000	20.000	244.00	190.00	9007690200000

Alternative Drill Series:

#768 Carbide, RT150GG, 4xD, 120 pt, Bright
 #6069 Carbide, RT150GG, 4xD, 130 pt, Bright
 #5512 Carbide, RT100, 7xD, 140 pt, FIREX®

15xD

Series 773

Application Materials:



Bright finish



Aluminum & Alloys



Cast Iron

Twist Drills

RT 150 GN, Negative Helix

Carbide, RT 150 GG straight flute high penetration, 15xD, 120° point, special web thin, reinforced straight shank, LH helix, RH cut

Cut Dia. = m7 tolerance range, Shank Dia. = h6

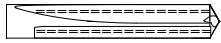

Coolant Through



Reinforced Straight Shank

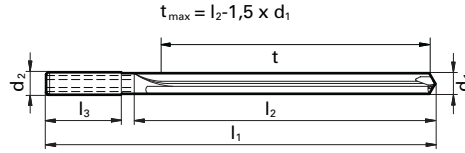

Speeds & Feeds information pg 456

Dec. inch	Diameter (d1)		mm	d2 mm	l1 mm	l2 mm	EDP #
	Fract. inch	Wire / letter					
0.1969			5.000	6.000	145.00	105.00	9007730050000
0.2362			6.000	6.000	145.00	105.00	9007730060000
0.3150			8.000	8.000	180.00	137.00	9007730080000
0.3543			9.000	10.000	217.00	170.00	9007730090000
0.3937			10.000	10.000	217.00	170.00	9007730100000
0.4331			11.000	12.000	258.00	205.00	9007730110000
0.4724			12.000	12.000	258.00	205.00	9007730120000
0.5512			14.000	14.000	290.00	236.00	9007730140000

Alternative Drill Series:

#5513 Carbide, RT150GG, 10xD, 120 pt, Bright

*Items listed in red are non-stocked items, and may take 2 - 6 weeks to receive

5xD

Bright finish



Coolant Through

Reinforced Straight Shank
w/Whistle NotchSpeeds & Feeds
information pg 458**Series 1131****GT 80 Parabolic**Cobalt, GT 80 IC, jobber length, 130° point, special web thinned
all dia., reinforced straight shank w/whistle notch, RH helix

Cut / Shank Dia. = h8 tolerance range

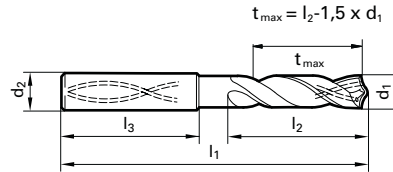

Application Materials:

- General Steels/Brass
- Universal Steels
- Cast Iron

Diameter (d1)		Wire / letter	d2 mm	l1 mm	l2 mm	EDP #	
Dec. inch	Fract. inch						
0.1969			5.000	6.000	82.00	44.00	9011310050000
0.2165			5.500	6.000	82.00	44.00	9011310055000
0.2362			6.000	6.000	82.00	44.00	9011310060000
0.2500	1/4	E	6.350	8.000	91.00	53.00	9011310063500
0.2559			6.500	8.000	91.00	53.00	9011310065000
0.2677			6.800	8.000	91.00	53.00	9011310068000
0.2756			7.000	8.000	91.00	53.00	9011310070000
0.2811	9/32	K	7.140	8.000	91.00	53.00	9011310071400
0.2953			7.500	8.000	91.00	53.00	9011310075000
0.3071			7.800	8.000	91.00	53.00	9011310078000
0.3126	5/16		7.940	8.000	91.00	53.00	9011310079400
0.3150			8.000	8.000	91.00	53.00	9011310080000
0.3346			8.500	10.000	103.00	61.00	9011310085000
0.3437	11/32		8.730	10.000	103.00	61.00	9011310087300
0.3543			9.000	10.000	103.00	61.00	9011310090000
0.3740			9.500	10.000	103.00	61.00	9011310095000
0.3748	3/8		9.520	10.000	103.00	61.00	9011310095200
0.3937			10.000	10.000	103.00	61.00	9011310100000
0.4016			10.200	12.000	118.00	71.00	9011310102000
0.4063	13/32		10.320	12.000	118.00	71.00	9011310103200
0.4134			10.500	12.000	118.00	71.00	9011310105000
0.4331			11.000	12.000	118.00	71.00	9011310110000
0.4374	7/16		11.110	12.000	118.00	71.00	9011310111100
0.4528			11.500	12.000	118.00	71.00	9011310115000
0.4689	15/32		11.910	12.000	118.00	71.00	9011310119100
0.4724			12.000	12.000	118.00	71.00	9011310120000

Diameter (d1)		Wire / letter	d2 mm	l1 mm	l2 mm	EDP #	
Dec. inch	Fract. inch						
0.4921			12.500	14.000	124.00	77.00	9011310125000
0.5000	1/2		12.700	14.000	124.00	77.00	9011310127000
0.5118			13.000	14.000	124.00	77.00	9011310130000
0.5311	17/32		13.490	14.000	124.00	77.00	9011310134900
0.5315			13.500	14.000	124.00	77.00	9011310135000
0.5512			14.000	14.000	124.00	77.00	9011310140000
0.5626	9/16		14.290	16.000	133.00	83.00	9011310142900
0.5709			14.500	16.000	133.00	83.00	9011310145000
0.5906			15.000	16.000	133.00	83.00	9011310150000
0.5937	19/32		15.080	16.000	133.00	83.00	9011310150800
0.6102			15.500	16.000	133.00	83.00	9011310155000
0.6248	5/8		15.870	16.000	133.00	83.00	9011310158700
0.6299			16.000	16.000	133.00	83.00	9011310160000
0.6496			16.500	18.000	143.00	93.00	9011310165000
0.6693			17.000	18.000	143.00	93.00	9011310170000
0.6890			17.500	18.000	143.00	93.00	9011310175000
0.7087			18.000	18.000	143.00	93.00	9011310180000
0.7283			18.500	20.000	153.00	101.00	9011310185000
0.7480			19.000	20.000	153.00	101.00	9011310190000
0.7677			19.500	20.000	153.00	101.00	9011310195000
0.7874			20.000	20.000	153.00	101.00	9011310200000

Alternative Drill Series:

#1132 Cobalt, GT80IC, 5xD, 130 pt, TiN

5xD



TiN coated



Coolant Through



Reinforced Straight Shank
w/Whistle Notch

Speeds & Feeds
information pg 458

Series 1132

GT 80 Parabolic

Cobalt, GT 80 IC, jobber length, 130° point, Special web thinned all dia., reinforced straight shank w/whistle notch, RH helix

Cut / Shank Dia. = h8 tolerance range

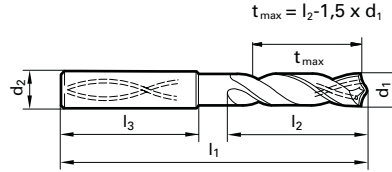

Application Materials:

- Hardened Materials
- Universal Steels
- Stainless Steels
- Cast Iron

Twist Drills

Diameter (d1)		Wire / letter	d2 mm	l1 mm	l2 mm	EDP #	
Dec. inch	Fract. inch						
0.1969			5.000	6.000	82.00	44.00	9011320050000
0.2165			5.500	6.000	82.00	44.00	9011320055000
0.2362			6.000	6.000	82.00	44.00	9011320060000
0.2500	1/4	E	6.350	8.000	91.00	53.00	9011320063500
0.2559			6.500	8.000	91.00	53.00	9011320065000
0.2677			6.800	8.000	91.00	53.00	9011320068000
0.2756			7.000	8.000	91.00	53.00	9011320070000
0.2811	9/32	K	7.140	8.000	91.00	53.00	9011320071400
0.2953			7.500	8.000	91.00	53.00	9011320075000
0.3071			7.800	8.000	91.00	53.00	9011320078000
0.3126	5/16		7.940	8.000	91.00	53.00	9011320079400
0.3150			8.000	8.000	91.00	53.00	9011320080000
0.3346			8.500	10.000	103.00	61.00	9011320085000
0.3437	11/32		8.730	10.000	103.00	61.00	9011320087300
0.3543			9.000	10.000	103.00	61.00	9011320090000
0.3740			9.500	10.000	103.00	61.00	9011320095000
0.3748	3/8		9.520	10.000	103.00	61.00	9011320095200
0.3937			10.000	10.000	103.00	61.00	9011320100000
0.4016			10.200	12.000	118.00	71.00	9011320102000
0.4063	13/32		10.320	12.000	118.00	71.00	9011320103200
0.4134			10.500	12.000	118.00	71.00	9011320105000
0.4331			11.000	12.000	118.00	71.00	9011320110000
0.4374	7/16		11.110	12.000	118.00	71.00	9011320111100
0.4528			11.500	12.000	118.00	71.00	9011320115000
0.4689	15/32		11.910	12.000	118.00	71.00	9011320119100
0.4724			12.000	12.000	118.00	71.00	9011320120000
0.4921			12.500	14.000	124.00	77.00	9011320125000

Diameter (d1)		Wire / letter	d2 mm	l1 mm	l2 mm	EDP #	
Dec. inch	Fract. inch						
0.5000	1/2		12.700	14.000	124.00	77.00	9011320127000
0.5118			13.000	14.000	124.00	77.00	9011320130000
0.5311	17/32		13.490	14.000	124.00	77.00	9011320134900
0.5315			13.500	14.000	124.00	77.00	9011320135000
0.5512			14.000	14.000	124.00	77.00	9011320140000
0.5626	9/16		14.290	16.000	133.00	83.00	9011320142900
0.5709			14.500	16.000	133.00	83.00	9011320145000
0.5906			15.000	16.000	133.00	83.00	9011320150000
0.5937	19/32		15.080	16.000	133.00	83.00	9011320150800
0.6102			15.500	16.000	133.00	83.00	9011320155000
0.6248	5/8		15.870	16.000	133.00	83.00	9011320158700
0.6299			16.000	16.000	133.00	83.00	9011320160000
0.6496			16.500	18.000	143.00	93.00	9011320165000
0.6693			17.000	18.000	143.00	93.00	9011320170000
0.6890			17.500	18.000	143.00	93.00	9011320175000
0.7087			18.000	18.000	143.00	93.00	9011320180000
0.7283			18.500	20.000	153.00	101.00	9011320185000
0.7480			19.000	20.000	153.00	101.00	9011320190000
0.7677			19.500	20.000	153.00	101.00	9011320195000
0.7874			20.000	20.000	153.00	101.00	9011320200000

Alternative Drill Series:

#1131 Cobalt, GT80IC, 5xD, 130 pt, Bright

*Items listed in red are non-stocked items, and may take 2 - 6 weeks to receive

Series 1183

Speeds & Feeds information pg 459

Diameter (d1)							
Dec. inch	Fract. inch	Wire / letter	mm	d2 mm	l1 mm	l2 mm	EDP #
0.4646			11.800	12.000	118.00	71.00	9011830118000
0.4685			11.900	12.000	118.00	71.00	9011830119000
0.4689	15/32		11.910	12.000	118.00	71.00	9011830119100
0.4724			12.000	12.000	118.00	71.00	9011830120000
0.4764			12.100	14.000	124.00	77.00	9011830121000
0.4803			12.200	14.000	124.00	77.00	9011830122000
0.4843	31/64		12.300	14.000	124.00	77.00	9011830123000
0.4882			12.400	14.000	124.00	77.00	9011830124000
0.4921			12.500	14.000	124.00	77.00	9011830125000
0.4961			12.600	14.000	124.00	77.00	9011830126000
0.5000	1/2		12.700	14.000	124.00	77.00	9011830127000
0.5039			12.800	14.000	124.00	77.00	9011830128000
0.5079			12.900	14.000	124.00	77.00	9011830129000
0.5118			13.000	14.000	124.00	77.00	9011830130000
0.5157	33/64		13.100	14.000	124.00	77.00	9011830131000
0.5197			13.200	14.000	124.00	77.00	9011830132000
0.5236			13.300	14.000	124.00	77.00	9011830133000
0.5276			13.400	14.000	124.00	77.00	9011830134000
0.5315			13.500	14.000	124.00	77.00	9011830135000
0.5354			13.600	14.000	124.00	77.00	9011830136000
0.5394			13.700	14.000	124.00	77.00	9011830137000
0.5433			13.800	14.000	124.00	77.00	9011830138000
0.5469	35/64		13.890	14.000	124.00	77.00	9011830138900
0.5472			13.900	14.000	124.00	77.00	9011830139000
0.5512			14.000	14.000	124.00	77.00	9011830140000
0.5551			14.100	16.000	133.00	83.00	9011830141000
0.5591			14.200	16.000	133.00	83.00	9011830142000
0.5626	9/16		14.290	16.000	133.00	83.00	9011830142900
0.5630			14.300	16.000	133.00	83.00	9011830143000
0.5669			14.400	16.000	133.00	83.00	9011830144000
0.5709			14.500	16.000	133.00	83.00	9011830145000
0.5748			14.600	16.000	133.00	83.00	9011830146000
0.5780	37/64		14.680	16.000	133.00	83.00	9011830146800
0.5787			14.700	16.000	133.00	83.00	9011830147000
0.5827			14.800	16.000	133.00	83.00	9011830148000
0.5866			14.900	16.000	133.00	83.00	9011830149000
0.5906			15.000	16.000	133.00	83.00	9011830150000
0.5945			15.100	16.000	133.00	83.00	9011830151000
0.5984			15.200	16.000	133.00	83.00	9011830152000
0.6024			15.300	16.000	133.00	83.00	9011830153000
0.6063			15.400	16.000	133.00	83.00	9011830154000
0.6094	39/64		15.480	16.000	133.00	83.00	9011830154800
0.6102			15.500	16.000	133.00	83.00	9011830155000
0.6142			15.600	16.000	133.00	83.00	9011830156000
0.6181			15.700	16.000	133.00	83.00	9011830157000
0.6220			15.800	16.000	133.00	83.00	9011830158000
0.6248	5/8		15.870	16.000	133.00	83.00	9011830158700
0.6260			15.900	16.000	133.00	83.00	9011830159000
0.6299			16.000	16.000	133.00	83.00	9011830160000
0.6339			16.100	18.000	143.00	93.00	9011830161000

Diameter (d1)							
Dec. inch	Fract. inch	Wire / letter	mm	d2 mm	l1 mm	l2 mm	EDP #
0.6378			16.200	18.000	143.00	93.00	9011830162000
0.6406	41/64		16.270	18.000	143.00	93.00	9011830162700
0.6417			16.300	18.000	143.00	93.00	9011830163000
0.6457			16.400	18.000	143.00	93.00	9011830164000
0.6496			16.500	18.000	143.00	93.00	9011830165000
0.6535			16.600	18.000	143.00	93.00	9011830166000
0.6575			16.700	18.000	143.00	93.00	9011830167000
0.6614			16.800	18.000	143.00	93.00	9011830168000
0.6654			16.900	18.000	143.00	93.00	9011830169000
0.6693			17.000	18.000	143.00	93.00	9011830170000
0.6720	43/64		17.070	18.000	143.00	93.00	9011830170700
0.6732			17.100	18.000	143.00	93.00	9011830171000
0.6772			17.200	18.000	143.00	93.00	9011830172000
0.6811			17.300	18.000	143.00	93.00	9011830173000
0.6850			17.400	18.000	143.00	93.00	9011830174000
0.6874	11/16		17.460	18.000	143.00	93.00	9011830174600
0.6890			17.500	18.000	143.00	93.00	9011830175000
0.6929			17.600	18.000	143.00	93.00	9011830176000
0.6969			17.700	18.000	143.00	93.00	9011830177000
0.7008			17.800	18.000	143.00	93.00	9011830178000
0.7031	45/64		17.860	18.000	143.00	93.00	9011830178600
0.7047			17.900	18.000	143.00	93.00	9011830179000
0.7087			18.000	18.000	143.00	93.00	9011830180000
0.7126			18.100	20.000	153.00	101.00	9011830181000
0.7165			18.200	20.000	153.00	101.00	9011830182000
0.7205			18.300	20.000	153.00	101.00	9011830183000
0.7244			18.400	20.000	153.00	101.00	9011830184000
0.7283			18.500	20.000	153.00	101.00	9011830185000
0.7323			18.600	20.000	153.00	101.00	9011830186000
0.7343	47/64		18.650	20.000	153.00	101.00	9011830186500
0.7362			18.700	20.000	153.00	101.00	9011830187000
0.7402			18.800	20.000	153.00	101.00	9011830188000
0.7441			18.900	20.000	153.00	101.00	9011830189000
0.7480			19.000	20.000	153.00	101.00	9011830190000
0.7500	3/4		19.050	20.000	153.00	101.00	9011830190500
0.7520			19.100	20.000	153.00	101.00	9011830191000
0.7559			19.200	20.000	153.00	101.00	9011830192000
0.7598			19.300	20.000	153.00	101.00	9011830193000
0.7657	49/64		19.450	20.000	153.00	101.00	9011830194500
0.7677			19.500	20.000	153.00	101.00	9011830195000
0.7717			19.600	20.000	153.00	101.00	9011830196000
0.7756			19.700	20.000	153.00	101.00	9011830197000
0.7795			19.800	20.000	153.00	101.00	9011830198000
0.7835			19.900	20.000	153.00	101.00	9011830199000
0.7874			20.000	20.000	153.00	101.00	9011830200000

Alternative Drill Series:

- #5511 Carbide, RT100, 5xD, 140 U pt, FIREX®
- #1662 Carbide, RT100, 5xD, 140 F pt, TIN

*Items listed in red are non-stocked items, and may take 2 - 6 weeks to receive

3xD



TiN coated



External Coolant

Reinforced Straight Shank
w/Whistle NotchSpeeds & Feeds
information pg 459

Series 1184

RT 100 U High Penetration

Carbide, RT 100 U high penetration, 3xD, self-centering 140° SU point,
reinforced straight shank with whistle notch, RH helix

Cut Dia. = m7 tolerance range, Shank Dia. = h6

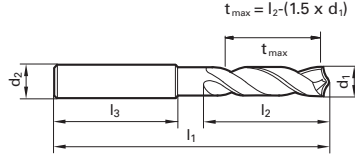

Application Materials:



Universal Steels



General Steels/Brass



Cast Iron

Diameter (d1)		Wire / letter	d2 mm	l1 mm	l2 mm	EDP #
Dec. inch	Fract. inch					
0.1181			3.000	6.000	62.00	9011840030000
0.1220			3.100	6.000	62.00	9011840031000
0.1248	1/8		3.170	6.000	62.00	9011840031700
0.1260			3.200	6.000	62.00	9011840032000
0.1299			3.300	6.000	62.00	9011840033000
0.1339			3.400	6.000	62.00	9011840034000
0.1378			3.500	6.000	62.00	9011840035000
0.1406	9/64	28	3.570	6.000	62.00	9011840035700
0.1417			3.600	6.000	62.00	9011840036000
0.1457			3.700	6.000	62.00	9011840037000
0.1496		25	3.800	6.000	66.00	9011840038000
0.1535			3.900	6.000	66.00	9011840039000
0.1563	5/32		3.970	6.000	66.00	9011840039700
0.1575			4.000	6.000	66.00	9011840040000
0.1614			4.100	6.000	66.00	9011840041000
0.1654			4.200	6.000	66.00	9011840042000
0.1693		18	4.300	6.000	66.00	9011840043000
0.1720	11/64		4.370	6.000	66.00	9011840043700
0.1732			4.400	6.000	66.00	9011840044000
0.1772		16	4.500	6.000	66.00	9011840045000
0.1811			4.600	6.000	66.00	9011840046000
0.1850		13	4.700	6.000	66.00	9011840047000
0.1874	3/16		4.760	6.000	66.00	9011840047600
0.1890		12	4.800	6.000	66.00	9011840048000
0.1929			4.900	6.000	66.00	9011840049000
0.1969			5.000	6.000	66.00	9011840050000
0.2008			5.100	6.000	66.00	9011840051000
0.2031	13/64		5.160	6.000	66.00	9011840051600
0.2047			5.200	6.000	66.00	9011840052000
0.2087			5.300	6.000	66.00	9011840053000
0.2126			5.400	6.000	66.00	9011840054000
0.2165			5.500	6.000	66.00	9011840055000
0.2189	7/32		5.560	6.000	66.00	9011840055600
0.2205			5.600	6.000	66.00	9011840056000
0.2244			5.700	6.000	66.00	9011840057000
0.2283			5.800	6.000	66.00	9011840058000
0.2323			5.900	6.000	66.00	9011840059000
0.2343	15/64		5.950	6.000	66.00	9011840059500
0.2362			6.000	6.000	66.00	9011840060000
0.2402			6.100	8.000	79.00	9011840061000
0.2441			6.200	8.000	79.00	9011840062000
0.2480			6.300	8.000	79.00	9011840063000
0.2500	1/4	E	6.350	8.000	79.00	9011840063500
0.2520			6.400	8.000	79.00	9011840064000
0.2559			6.500	8.000	79.00	9011840065000
0.2598			6.600	8.000	79.00	9011840066000
0.2638			6.700	8.000	79.00	9011840067000
0.2657	17/64	H	6.750	8.000	79.00	9011840067500
0.2677			6.800	8.000	79.00	9011840068000
0.2717		I	6.900	8.000	79.00	9011840069000
0.2756			7.000	8.000	79.00	9011840070000
0.2795			7.100	8.000	79.00	9011840071000
0.2811	9/32	K	7.140	8.000	79.00	9011840071400
0.2835			7.200	8.000	79.00	9011840072000

Diameter (d1)		Wire / letter	d2 mm	l1 mm	l2 mm	EDP #
Dec. inch	Fract. inch					
0.2874			7.300	8.000	79.00	9011840073000
0.2913			7.400	8.000	79.00	9011840074000
0.2953			7.500	8.000	79.00	9011840075000
0.2969	19/64		7.540	8.000	79.00	9011840075400
0.2992			7.600	8.000	79.00	9011840076000
0.3031			7.700	8.000	79.00	9011840077000
0.3071			7.800	8.000	79.00	9011840078000
0.3110			7.900	8.000	79.00	9011840079000
0.3126	5/16		7.940	8.000	79.00	9011840079400
0.3150			8.000	8.000	79.00	9011840080000
0.3189			8.100	10.000	89.00	9011840081000
0.3228		P	8.200	10.000	89.00	9011840082000
0.3268			8.300	10.000	89.00	9011840083000
0.3280	21/64		8.330	10.000	89.00	9011840083300
0.3307			8.400	10.000	89.00	9011840084000
0.3346			8.500	10.000	89.00	9011840085000
0.3386			8.600	10.000	89.00	9011840086000
0.3425			8.700	10.000	89.00	9011840087000
0.3437	11/32		8.730	10.000	89.00	9011840087300
0.3465			8.800	10.000	89.00	9011840088000
0.3504			8.900	10.000	89.00	9011840089000
0.3543			9.000	10.000	89.00	9011840090000
0.3583			9.100	10.000	89.00	9011840091000
0.3594	23/64		9.130	10.000	89.00	9011840091300
0.3622			9.200	10.000	89.00	9011840092000
0.3661			9.300	10.000	89.00	9011840093000
0.3701			9.400	10.000	89.00	9011840094000
0.3740			9.500	10.000	89.00	9011840095000
0.3748	3/8		9.520	10.000	89.00	9011840095200
0.3780			9.600	10.000	89.00	9011840096000
0.3819			9.700	10.000	89.00	9011840097000
0.3858		W	9.800	10.000	89.00	9011840098000
0.3898			9.900	10.000	89.00	9011840099000
0.3906	25/64		9.920	10.000	89.00	9011840099200
0.3937			10.000	10.000	89.00	9011840100000
0.3976			10.100	12.000	102.00	9011840101000
0.4016			10.200	12.000	102.00	9011840102000
0.4055			10.300	12.000	102.00	9011840103000
0.4063	13/32		10.320	12.000	102.00	9011840103200
0.4094			10.400	12.000	102.00	9011840104000
0.4134			10.500	12.000	102.00	9011840105000
0.4173			10.600	12.000	102.00	9011840106000
0.4213			10.700	12.000	102.00	9011840107000
0.4220	27/64		10.720	12.000	102.00	9011840107200
0.4252			10.800	12.000	102.00	9011840108000
0.4291			10.900	12.000	102.00	9011840109000
0.4331			11.000	12.000	102.00	9011840110000
0.4370			11.100	12.000	102.00	9011840111000
0.4374	7/16		11.110	12.000	102.00	9011840111100
0.4409			11.200	12.000	102.00	9011840112000
0.4449			11.300	12.000	102.00	9011840113000
0.4488			11.400	12.000	102.00	9011840114000
0.4528			11.500	12.000	102.00	9011840115000
0.4531	29/64		11.510	12.000	102.00	9011840115100

Series 1184

Speeds & Feeds information pg 459

Twist Drills

Dec. inch	Diameter (d1)		d2 mm	l1 mm	l2 mm	EDP #	
	Fract. inch	Wire / letter					
0.4567			11.600	12.000	102.00	55.00	9011840116000
0.4606			11.700	12.000	102.00	55.00	9011840117000
0.4646			11.800	12.000	102.00	55.00	9011840118000
0.4685			11.900	12.000	102.00	55.00	9011840119000
0.4689	15/32		11.910	12.000	102.00	55.00	9011840119100
0.4724			12.000	12.000	102.00	55.00	9011840120000
0.4764			12.100	14.000	107.00	60.00	9011840121000
0.4803			12.200	14.000	107.00	60.00	9011840122000
0.4843	31/64		12.300	14.000	107.00	60.00	9011840123000
0.4882			12.400	14.000	107.00	60.00	9011840124000
0.4921			12.500	14.000	107.00	60.00	9011840125000
0.4961			12.600	14.000	107.00	60.00	9011840126000
0.5000	1/2		12.700	14.000	107.00	60.00	9011840127000
0.5039			12.800	14.000	107.00	60.00	9011840128000
0.5118			13.000	14.000	107.00	60.00	9011840130000
0.5157	33/64		13.100	14.000	107.00	60.00	9011840131000
0.5197			13.200	14.000	107.00	60.00	9011840132000
0.5236			13.300	14.000	107.00	60.00	9011840133000
0.5315			13.500	14.000	107.00	60.00	9011840135000
0.5354			13.600	14.000	107.00	60.00	9011840136000
0.5394			13.700	14.000	107.00	60.00	9011840137000
0.5433			13.800	14.000	107.00	60.00	9011840138000
0.5469	35/64		13.890	14.000	107.00	60.00	9011840138900
0.5472			13.900	14.000	107.00	60.00	9011840139000
0.5512			14.000	14.000	107.00	60.00	9011840140000
0.5591			14.200	16.000	115.00	65.00	9011840142000
0.5626	9/16		14.290	16.000	115.00	65.00	9011840142900
0.5630			14.300	16.000	115.00	65.00	9011840143000
0.5669			14.400	16.000	115.00	65.00	9011840144000
0.5709			14.500	16.000	115.00	65.00	9011840145000
0.5748			14.600	16.000	115.00	65.00	9011840146000
0.5787			14.700	16.000	115.00	65.00	9011840147000
0.5827			14.800	16.000	115.00	65.00	9011840148000
0.5906			15.000	16.000	115.00	65.00	9011840150000
0.5945			15.100	16.000	115.00	65.00	9011840151000
0.5984			15.200	16.000	115.00	65.00	9011840152000
0.6063			15.400	16.000	115.00	65.00	9011840154000
0.6094	39/64		15.480	16.000	115.00	65.00	9011840154800

Dec. inch	Diameter (d1)		d2 mm	l1 mm	l2 mm	EDP #	
	Fract. inch	Wire / letter					
0.6102			15.500	16.000	115.00	65.00	9011840155000
0.6142			15.600	16.000	115.00	65.00	9011840156000
0.6181			15.700	16.000	115.00	65.00	9011840157000
0.6220			15.800	16.000	115.00	65.00	9011840158000
0.6248	5/8		15.870	16.000	115.00	65.00	9011840158700
0.6260			15.900	16.000	115.00	65.00	9011840159000
0.6299			16.000	16.000	115.00	65.00	9011840160000
0.6339			16.100	18.000	123.00	73.00	9011840161000
0.6378			16.200	18.000	123.00	73.00	9011840162000
0.6406	41/64		16.270	18.000	123.00	73.00	9011840162700
0.6417			16.300	18.000	123.00	73.00	9011840163000
0.6496			16.500	18.000	123.00	73.00	9011840165000
0.6614			16.800	18.000	123.00	73.00	9011840168000
0.6693			17.000	18.000	123.00	73.00	9011840170000
0.6811			17.300	18.000	123.00	73.00	9011840173000
0.6874	11/16		17.460	18.000	123.00	73.00	9011840174600
0.6890			17.500	18.000	123.00	73.00	9011840175000
0.6969			17.700	18.000	123.00	73.00	9011840177000
0.7008			17.800	18.000	123.00	73.00	9011840178000
0.7031	45/64		17.860	18.000	123.00	73.00	9011840178600
0.7087			18.000	18.000	123.00	73.00	9011840180000
0.7126			18.100	20.000	131.00	79.00	9011840181000
0.7205			18.300	20.000	131.00	79.00	9011840183000
0.7283			18.500	20.000	131.00	79.00	9011840185000
0.7343	47/64		18.650	20.000	131.00	79.00	9011840186500
0.7480			19.000	20.000	131.00	79.00	9011840190000
0.7500	3/4		19.050	20.000	131.00	79.00	9011840190500
0.7559			19.200	20.000	131.00	79.00	9011840192000
0.7677			19.500	20.000	131.00	79.00	9011840195000
0.7717			19.600	20.000	131.00	79.00	9011840196000
0.7795			19.800	20.000	131.00	79.00	9011840198000
0.7874			20.000	20.000	131.00	79.00	9011840200000

Alternative Drill Series:

- #1242 Carbide, RT100, 3xD, 140 U pt, TiN
- #5514 Carbide, RT100, 3xD, 140 U pt, FIREX®
- #1702 Carbide, RT100, 3xD, 140 F pt, TiN

*Items listed in red are non-stocked items, and may take 2 - 6 weeks to receive

5xD

TiCN coated



External Coolant



Straight Shank

Speeds & Feeds
information pg 460**Series 1221****GT 100 Parabolic**Cobalt, GT 100, jobber length, 130° point, Form A web thinned all dia.,
standard straight shank, RH helix

Cut / Shank Dia. = h8 tolerance range

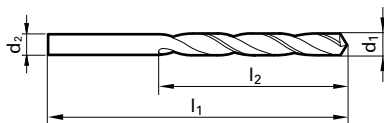

$$d_1 = d_2$$

Application Materials:



Universal Steels



Stainless Steels



Cast Iron

Dec. inch	Diameter (d1)			l1 mm	l2 mm	EDP #
	Fract. inch	Wire / letter	mm			
0.1181			3.000	61.00	33.00	9012210030000
0.1201		31	3.050	65.00	36.00	9012210030500
0.1220			3.100	65.00	36.00	9012210031000
0.1248	1/8		3.170	65.00	36.00	9012210031700
0.1260			3.200	65.00	36.00	9012210032000
0.1299			3.300	65.00	36.00	9012210033000
0.1339			3.400	70.00	39.00	9012210034000
0.1358		29	3.450	70.00	39.00	9012210034500
0.1378			3.500	70.00	39.00	9012210035000
0.1406	9/64	28	3.570	70.00	39.00	9012210035700
0.1417			3.600	70.00	39.00	9012210036000
0.1441		27	3.660	70.00	39.00	9012210036600
0.1457			3.700	70.00	39.00	9012210037000
0.1476			3.750	70.00	39.00	9012210037500
0.1496		25	3.800	75.00	43.00	9012210038000
0.1535			3.900	75.00	43.00	9012210039000
0.1563	5/32		3.970	75.00	43.00	9012210039700
0.1575			4.000	75.00	43.00	9012210040000
0.1587			4.030	75.00	43.00	9012210040300
0.1594			4.050	75.00	43.00	9012210040500
0.1614			4.100	75.00	43.00	9012210041000
0.1654			4.200	75.00	43.00	9012210042000
0.1693		18	4.300	80.00	47.00	9012210043000
0.1720	11/64		4.370	80.00	47.00	9012210043700
0.1732			4.400	80.00	47.00	9012210044000
0.1772		16	4.500	80.00	47.00	9012210045000
0.1811			4.600	80.00	47.00	9012210046000
0.1850		13	4.700	80.00	47.00	9012210047000
0.1874	3/16		4.760	86.00	52.00	9012210047600
0.1890		12	4.800	86.00	52.00	9012210048000
0.1929			4.900	86.00	52.00	9012210049000
0.1961		9	4.980	86.00	52.00	9012210049800
0.1969			5.000	86.00	52.00	9012210050000
0.2008			5.100	86.00	52.00	9012210051000
0.2047			5.200	86.00	52.00	9012210052000
0.2087			5.300	86.00	52.00	9012210053000
0.2126			5.400	93.00	57.00	9012210054000
0.2165			5.500	93.00	57.00	9012210055000
0.2189	7/32		5.560	93.00	57.00	9012210055600
0.2205			5.600	93.00	57.00	9012210056000
0.2244			5.700	93.00	57.00	9012210057000
0.2283			5.800	93.00	57.00	9012210058000
0.2323			5.900	93.00	57.00	9012210059000
0.2343	15/64		5.950	93.00	57.00	9012210059500
0.2362			6.000	93.00	57.00	9012210060000
0.2402			6.100	101.00	63.00	9012210061000
0.2441			6.200	101.00	63.00	9012210062000
0.2480			6.300	101.00	63.00	9012210063000
0.2500	1/4	E	6.350	101.00	63.00	9012210063500

Dec. inch	Diameter (d1)			l1 mm	l2 mm	EDP #
	Fract. inch	Wire / letter	mm			
0.2520			6.400	101.00	63.00	9012210064000
0.2559			6.500	101.00	63.00	9012210065000
0.2598			6.600	101.00	63.00	9012210066000
0.2638			6.700	101.00	63.00	9012210067000
0.2677			6.800	109.00	69.00	9012210068000
0.2717		I	6.900	109.00	69.00	9012210069000
0.2756			7.000	109.00	69.00	9012210070000
0.2795			7.100	109.00	69.00	9012210071000
0.2811	9/32	K	7.140	109.00	69.00	9012210071400
0.2835			7.200	109.00	69.00	9012210072000
0.2874			7.300	109.00	69.00	9012210073000
0.2913			7.400	109.00	69.00	9012210074000
0.2953			7.500	109.00	69.00	9012210075000
0.3031			7.700	117.00	75.00	9012210077000
0.3071			7.800	117.00	75.00	9012210078000
0.3110			7.900	117.00	75.00	9012210079000
0.3150			8.000	117.00	75.00	9012210080000
0.3189			8.100	117.00	75.00	9012210081000
0.3228		P	8.200	117.00	75.00	9012210082000
0.3307			8.400	117.00	75.00	9012210084000
0.3346			8.500	117.00	75.00	9012210085000
0.3386			8.600	125.00	81.00	9012210086000
0.3425			8.700	125.00	81.00	9012210087000
0.3465			8.800	125.00	81.00	9012210088000
0.3504			8.900	125.00	81.00	9012210089000
0.3543			9.000	125.00	81.00	9012210090000
0.3594	23/64		9.130	125.00	81.00	9012210091300
0.3740			9.500	125.00	81.00	9012210095000
0.3748	3/8		9.520	133.00	87.00	9012210095200
0.3898			9.900	133.00	87.00	9012210099000
0.3906	25/64		9.920	133.00	87.00	9012210099200
0.3937			10.000	133.00	87.00	9012210100000
0.4016			10.200	133.00	87.00	9012210102000
0.4134			10.500	133.00	87.00	9012210105000
0.4213			10.700	142.00	94.00	9012210107000
0.4220	27/64		10.720	142.00	94.00	9012210107200
0.4252			10.800	142.00	94.00	9012210108000
0.4331			11.000	142.00	94.00	9012210110000
0.4528			11.500	142.00	94.00	9012210115000
0.4689	15/32		11.910	151.00	101.00	9012210119100
0.4724			12.000	151.00	101.00	9012210120000

Alternative Drill Series:

#530 PM Cobalt, GT500, 5xD, 130 pt, FIREX®
 #622 Cobalt, GT100, 5xD, 130 pt, Bright/Nitrided lands > 2.36
 #549 HSS, GT100, 5xD, 130 pt, Bright/Nitrided lands > 2.36
 #652 HSS, GT100, 5xD, 130 pt, TiN

5xD

A

TiAlN coated



External Coolant



Straight Shank

Speeds & Feeds
information pg 460

Series 1223

GT 100 Parabolic

Cobalt, GT 100, jobber length, 130° point, Form A web thinned all dia., standard straight shank, RH helix

Cut / Shank Dia. = h8 tolerance range

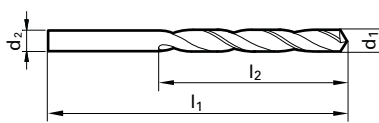

$d_1 = d_2$

Application Materials:

- Universal Steels
- Stainless Steels
- Hardened Materials
- Cast Iron

Twist Drills

Dec. Inch	Fract. Inch	Wire / letter	Diameter (d1) mm	l1 mm	l2 mm	EDP #
0.1181			3.000	61.00	33.00	9012230030000
0.1201		31	3.050	65.00	36.00	9012230030500
0.1220			3.100	65.00	36.00	9012230031000
0.1248	1/8		3.170	65.00	36.00	9012230031700
0.1260			3.200	65.00	36.00	9012230032000
0.1299			3.300	65.00	36.00	9012230033000
0.1339			3.400	70.00	39.00	9012230034000
0.1358		29	3.450	70.00	39.00	9012230034500
0.1378			3.500	70.00	39.00	9012230035000
0.1417			3.600	70.00	39.00	9012230036000
0.1457			3.700	70.00	39.00	9012230037000
0.1496		25	3.800	75.00	43.00	9012230038000
0.1535			3.900	75.00	43.00	9012230039000
0.1563	5/32		3.970	75.00	43.00	9012230039700
0.1575			4.000	75.00	43.00	9012230040000
0.1587			4.030	75.00	43.00	9012230040300
0.1591		21	4.040	75.00	43.00	9012230040400
0.1594			4.050	75.00	43.00	9012230040500
0.1614			4.100	75.00	43.00	9012230041000
0.1654			4.200	75.00	43.00	9012230042000
0.1693		18	4.300	80.00	47.00	9012230043000
0.1720	11/64		4.370	80.00	47.00	9012230043700
0.1732			4.400	80.00	47.00	9012230044000
0.1772		16	4.500	80.00	47.00	9012230045000
0.1811			4.600	80.00	47.00	9012230046000
0.1850		13	4.700	80.00	47.00	9012230047000
0.1874	3/16		4.760	86.00	52.00	9012230047600
0.1890		12	4.800	86.00	52.00	9012230048000
0.1929			4.900	86.00	52.00	9012230049000
0.1937		10	4.920	86.00	52.00	9012230049200
0.1961		9	4.980	86.00	52.00	9012230049800
0.1969			5.000	86.00	52.00	9012230050000
0.2008			5.100	86.00	52.00	9012230051000
0.2031	13/64		5.160	86.00	52.00	9012230051600
0.2047			5.200	86.00	52.00	9012230052000
0.2087			5.300	86.00	52.00	9012230053000
0.2126			5.400	93.00	57.00	9012230054000
0.2165			5.500	93.00	57.00	9012230055000
0.2189	7/32		5.560	93.00	57.00	9012230055600
0.2205			5.600	93.00	57.00	9012230056000
0.2244			5.700	93.00	57.00	9012230057000
0.2283			5.800	93.00	57.00	9012230058000
0.2323			5.900	93.00	57.00	9012230059000
0.2343	15/64		5.950	93.00	57.00	9012230059500
0.2362			6.000	93.00	57.00	9012230060000
0.2402			6.100	101.00	63.00	9012230061000
0.2441			6.200	101.00	63.00	9012230062000
0.2480			6.300	101.00	63.00	9012230063000
0.2500	1/4	E	6.350	101.00	63.00	9012230063500
0.2520			6.400	101.00	63.00	9012230064000
0.2559			6.500	101.00	63.00	9012230065000
0.2598			6.600	101.00	63.00	9012230066000
0.2638			6.700	101.00	63.00	9012230067000
0.2677			6.800	109.00	69.00	9012230068000
0.2717		I	6.900	109.00	69.00	9012230069000

Dec. Inch	Fract. Inch	Wire / letter	Diameter (d1) mm	l1 mm	l2 mm	EDP #
0.2756			7.000	109.00	69.00	9012230070000
0.2795			7.100	109.00	69.00	9012230071000
0.2811	9/32	K	7.140	109.00	69.00	9012230071400
0.2835			7.200	109.00	69.00	9012230072000
0.2874			7.300	109.00	69.00	9012230073000
0.2913			7.400	109.00	69.00	9012230074000
0.2953			7.500	109.00	69.00	9012230075000
0.2992			7.600	117.00	75.00	9012230076000
0.3071			7.800	117.00	75.00	9012230078000
0.3110			7.900	117.00	75.00	9012230079000
0.3126	5/16		7.940	117.00	75.00	9012230079400
0.3150			8.000	117.00	75.00	9012230080000
0.3189			8.100	117.00	75.00	9012230081000
0.3228		P	8.200	117.00	75.00	9012230082000
0.3268			8.300	117.00	75.00	9012230083000
0.3307			8.400	117.00	75.00	9012230084000
0.3346			8.500	117.00	75.00	9012230085000
0.3386			8.600	125.00	81.00	9012230086000
0.3425			8.700	125.00	81.00	9012230087000
0.3437	11/32		8.730	125.00	81.00	9012230087300
0.3465			8.800	125.00	81.00	9012230088000
0.3504			8.900	125.00	81.00	9012230089000
0.3543			9.000	125.00	81.00	9012230090000
0.3594	23/64		9.130	125.00	81.00	9012230091300
0.3622			9.200	125.00	81.00	9012230092000
0.3740			9.500	125.00	81.00	9012230095000
0.3748	3/8		9.520	133.00	87.00	9012230095200
0.3752			9.530	133.00	87.00	9012230095300
0.3858		W	9.800	133.00	87.00	9012230098000
0.3898			9.900	133.00	87.00	9012230099000
0.3906	25/64		9.920	133.00	87.00	9012230099200
0.3937			10.000	133.00	87.00	9012230100000
0.3976			10.100	133.00	87.00	9012230101000
0.4016			10.200	133.00	87.00	9012230102000
0.4055			10.300	133.00	87.00	9012230103000
0.4063	13/32		10.320	133.00	87.00	9012230103200
0.4134			10.500	133.00	87.00	9012230105000
0.4213			10.700	142.00	94.00	9012230107000
0.4220	27/64		10.720	142.00	94.00	9012230107200
0.4252			10.800	142.00	94.00	9012230108000
0.4331			11.000	142.00	94.00	9012230110000
0.4374	7/16		11.110	142.00	94.00	9012230111100
0.4409			11.200	142.00	94.00	9012230112000
0.4528			11.500	142.00	94.00	9012230115000
0.4606			11.700	142.00	94.00	9012230117000
0.4689	15/32		11.910	151.00	101.00	9012230119100
0.4724			12.000	151.00	101.00	9012230120000

Alternative Drill Series:
#530 PM Cobalt, GT500, 5xD, 130 pt, FIREX®
#622 Cobalt, GT100, 5xD, 130 pt, Bright/Nitrided lands > 2.36
#652 HSS, GT100, 5xD, 130 pt, TiN
#549 HSS, GT100, 5xD, 130 pt, Bright/Nitrided lands > 2.36

*Items listed in red are non-stocked items, and may take 2 - 6 weeks to receive

3xD



TiN coated



External Coolant



Straight Shank

Speeds & Feeds information pg 461

Series 1242

RT 100 U High Penetration

Carbide, RT 100 U high penetration, 3xD, self-centering 140° SU point, standard straight shank, RH helix

Cut Dia. = m7 tolerance range, Shank Dia. = h6

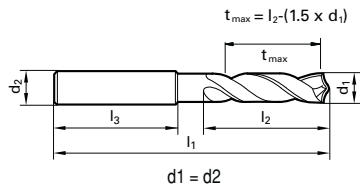

Application Materials:



Universal Steels



General Steels/Brass



Cast Iron

Dec. inch	Diameter (d1)			l1 mm	l2 mm	EDP #
	Fract. inch	Wire / letter	mm			
0.1181			3.000	46.00	16.00	9012420030000
0.1220			3.100	49.00	18.00	9012420031000
0.1248	1/8		3.170	49.00	18.00	9012420031700
0.1260			3.200	49.00	18.00	9012420032000
0.1299			3.300	49.00	18.00	9012420033000
0.1339			3.400	52.00	20.00	9012420034000
0.1378			3.500	52.00	20.00	9012420035000
0.1406	9/64	28	3.570	52.00	20.00	9012420035700
0.1417			3.600	52.00	20.00	9012420036000
0.1457			3.700	52.00	20.00	9012420037000
0.1496		25	3.800	55.00	22.00	9012420038000
0.1535			3.900	55.00	22.00	9012420039000
0.1563	5/32		3.970	55.00	22.00	9012420039700
0.1575			4.000	55.00	22.00	9012420040000
0.1614			4.100	55.00	22.00	9012420041000
0.1654			4.200	55.00	22.00	9012420042000
0.1693		18	4.300	58.00	24.00	9012420043000
0.1720	11/64		4.370	58.00	24.00	9012420043700
0.1732			4.400	58.00	24.00	9012420044000
0.1772		16	4.500	58.00	24.00	9012420045000
0.1811			4.600	58.00	24.00	9012420046000
0.1850		13	4.700	58.00	24.00	9012420047000
0.1874	3/16		4.760	62.00	26.00	9012420047600
0.1890		12	4.800	62.00	26.00	9012420048000
0.1929			4.900	62.00	26.00	9012420049000
0.1969			5.000	62.00	26.00	9012420050000
0.2008			5.100	62.00	26.00	9012420051000
0.2031	13/64		5.160	62.00	26.00	9012420051600
0.2047			5.200	62.00	26.00	9012420052000
0.2087			5.300	62.00	26.00	9012420053000
0.2126			5.400	66.00	28.00	9012420054000
0.2165			5.500	66.00	28.00	9012420055000
0.2189	7/32		5.560	66.00	28.00	9012420055600
0.2205			5.600	66.00	28.00	9012420056000
0.2244			5.700	66.00	28.00	9012420057000
0.2283			5.800	66.00	28.00	9012420058000
0.2323			5.900	66.00	28.00	9012420059000
0.2343	15/64		5.950	66.00	28.00	9012420059500
0.2362			6.000	66.00	28.00	9012420060000
0.2402			6.100	70.00	31.00	9012420061000
0.2441			6.200	70.00	31.00	9012420062000
0.2480			6.300	70.00	31.00	9012420063000
0.2500	1/4	E	6.350	70.00	31.00	9012420063500
0.2520			6.400	70.00	31.00	9012420064000
0.2559			6.500	70.00	31.00	9012420065000
0.2598			6.600	70.00	31.00	9012420066000
0.2638			6.700	70.00	31.00	9012420067000
0.2657	17/64	H	6.750	74.00	34.00	9012420067500
0.2677			6.800	74.00	34.00	9012420068000
0.2717		I	6.900	74.00	34.00	9012420069000
0.2756			7.000	74.00	34.00	9012420070000
0.2795			7.100	74.00	34.00	9012420071000

Dec. inch	Diameter (d1)			l1 mm	l2 mm	EDP #
	Fract. inch	Wire / letter	mm			
0.2811	9/32	K	7.140	74.00	34.00	9012420071400
0.2835			7.200	74.00	34.00	9012420072000
0.2874			7.300	74.00	34.00	9012420073000
0.2913			7.400	74.00	34.00	9012420074000
0.2953			7.500	74.00	34.00	9012420075000
0.2969	19/64		7.540	79.00	37.00	9012420075400
0.2992			7.600	79.00	37.00	9012420076000
0.3031			7.700	79.00	37.00	9012420077000
0.3071			7.800	79.00	37.00	9012420078000
0.3110			7.900	79.00	37.00	9012420079000
0.3126	5/16		7.940	79.00	37.00	9012420079400
0.3150			8.000	79.00	37.00	9012420080000
0.3189			8.100	79.00	37.00	9012420081000
0.3228		P	8.200	79.00	37.00	9012420082000
0.3268			8.300	79.00	37.00	9012420083000
0.3280	21/64		8.330	79.00	37.00	9012420083300
0.3307			8.400	79.00	37.00	9012420084000
0.3346			8.500	79.00	37.00	9012420085000
0.3386			8.600	84.00	40.00	9012420086000
0.3425			8.700	84.00	40.00	9012420087000
0.3437	11/32		8.730	84.00	40.00	9012420087300
0.3465			8.800	84.00	40.00	9012420088000
0.3504			8.900	84.00	40.00	9012420089000
0.3543			9.000	84.00	40.00	9012420090000
0.3583			9.100	84.00	40.00	9012420091000
0.3594	23/64		9.130	84.00	40.00	9012420091300
0.3622			9.200	84.00	40.00	9012420092000
0.3661			9.300	84.00	40.00	9012420093000
0.3701			9.400	84.00	40.00	9012420094000
0.3740			9.500	84.00	40.00	9012420095000
0.3748	3/8		9.520	89.00	43.00	9012420095200
0.3780			9.600	89.00	43.00	9012420096000
0.3819			9.700	89.00	43.00	9012420097000
0.3858		W	9.800	89.00	43.00	9012420098000
0.3898			9.900	89.00	43.00	9012420099000
0.3906	25/64		9.920	89.00	43.00	9012420099200
0.3937			10.000	89.00	43.00	9012420100000
0.3976			10.100	89.00	43.00	9012420101000
0.4016			10.200	89.00	43.00	9012420102000
0.4055			10.300	89.00	43.00	9012420103000
0.4063	13/32		10.320	89.00	43.00	9012420103200
0.4094			10.400	89.00	43.00	9012420104000
0.4134			10.500	89.00	43.00	9012420105000
0.4173			10.600	89.00	43.00	9012420106000
0.4213			10.700	95.00	47.00	9012420107000
0.4220	27/64		10.720	95.00	47.00	9012420107200
0.4252			10.800	95.00	47.00	9012420108000
0.4291			10.900	95.00	47.00	9012420109000
0.4331			11.000	95.00	47.00	9012420110000
0.4370			11.100	95.00	47.00	9012420111000
0.4374	7/16		11.110	95.00	47.00	9012420111100
0.4409			11.200	95.00	47.00	9012420112000

Series 1242

Speeds & Feeds information pg 461

Dec. inch	Diameter (d1)		I1 mm	I2 mm	EDP #	
	Fract. inch	Wire / letter				
0.4449			11.300	95.00	47.00	9012420113000
0.4488			11.400	95.00	47.00	9012420114000
0.4528			11.500	95.00	47.00	9012420115000
0.4531	29/64		11.510	95.00	47.00	9012420115100
0.4567			11.600	95.00	47.00	9012420116000
0.4606			11.700	95.00	47.00	9012420117000
0.4646			11.800	95.00	47.00	9012420118000
0.4685			11.900	102.00	51.00	9012420119000
0.4689	15/32		11.910	102.00	51.00	9012420119100
0.4724			12.000	102.00	51.00	9012420120000
0.4921			12.500	102.00	51.00	9012420125000
0.5000	1/2		12.700	102.00	51.00	9012420127000
0.5118			13.000	102.00	51.00	9012420130000
0.5315			13.500	107.00	54.00	9012420135000
0.5512			14.000	107.00	54.00	9012420140000
0.5709			14.500	111.00	56.00	9012420145000
0.5906			15.000	111.00	56.00	9012420150000
0.6102			15.500	115.00	58.00	9012420155000
0.6299			16.000	115.00	58.00	9012420160000

Alternative Drill Series:

- #1702 Carbide, RT100, 3xD, 140 F pt, TiN
- #1184 Carbide, RT100, 3xD, 140 U pt, TiN
- #5514 Carbide, RT100, 3xD, 140 U pt, FIREX®

*Items listed in red are non-stocked items, and may take 2 - 6 weeks to receive

5xD



TiN coated



External Coolant



Straight Shank

Speeds & Feeds
information pg 461

Series 1243

RT 100 U High Penetration

Carbide, RT 100 U high penetration, 5xD, self-centering
140° SU point, standard straight shank, RH helix

Cut Dia. = m7 tolerance range, Shank Dia. = h6

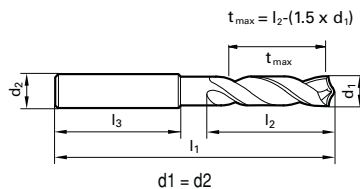

Application Materials:

- Universal Steels
- General Steels/Brass
- Cast Iron

Dec. inch	Fract. inch	Wire / letter	Diameter (d1) mm	l1 mm	l2 mm	EDP #
0.1969			5.000	73.00	34.00	9012430050000
0.2008			5.100	76.00	38.00	9012430051000
0.2031	13/64		5.160	76.00	38.00	9012430051600
0.2047			5.200	76.00	38.00	9012430052000
0.2087			5.300	76.00	38.00	9012430053000
0.2126			5.400	76.00	38.00	9012430054000
0.2165			5.500	76.00	38.00	9012430055000
0.2189	7/32		5.560	81.00	41.00	9012430055600
0.2205			5.600	81.00	41.00	9012430056000
0.2244			5.700	81.00	41.00	9012430057000
0.2283			5.800	81.00	41.00	9012430058000
0.2323			5.900	81.00	41.00	9012430059000
0.2343	15/64		5.950	81.00	41.00	9012430059500
0.2362			6.000	81.00	41.00	9012430060000
0.2402			6.100	81.00	41.00	9012430061000
0.2441			6.200	81.00	41.00	9012430062000
0.2480			6.300	81.00	41.00	9012430063000
0.2500	1/4	E	6.350	81.00	41.00	9012430063500
0.2520			6.400	81.00	41.00	9012430064000
0.2559			6.500	81.00	41.00	9012430065000
0.2598			6.600	83.00	43.00	9012430066000
0.2638			6.700	83.00	43.00	9012430067000
0.2657	17/64	H	6.750	83.00	43.00	9012430067500
0.2677			6.800	83.00	43.00	9012430068000
0.2717		I	6.900	83.00	43.00	9012430069000
0.2756			7.000	83.00	43.00	9012430070000
0.2795			7.100	87.00	45.00	9012430071000
0.2811	9/32	K	7.140	87.00	45.00	9012430071400
0.2835			7.200	87.00	45.00	9012430072000
0.2874			7.300	87.00	45.00	9012430073000
0.2913			7.400	87.00	45.00	9012430074000
0.2953			7.500	87.00	45.00	9012430075000
0.2969	19/64		7.540	90.00	48.00	9012430075400
0.2992			7.600	90.00	48.00	9012430076000
0.3031			7.700	90.00	48.00	9012430077000
0.3071			7.800	90.00	48.00	9012430078000
0.3110			7.900	90.00	48.00	9012430079000
0.3126	5/16		7.940	90.00	48.00	9012430079400
0.3150			8.000	90.00	48.00	9012430080000
0.3189			8.100	96.00	53.00	9012430081000
0.3228		P	8.200	96.00	53.00	9012430082000
0.3268			8.300	96.00	53.00	9012430083000
0.3280	21/64		8.330	96.00	53.00	9012430083300
0.3307			8.400	96.00	53.00	9012430084000
0.3346			8.500	96.00	53.00	9012430085000
0.3386			8.600	98.00	55.00	9012430086000
0.3425			8.700	98.00	55.00	9012430087000
0.3437	11/32		8.730	98.00	55.00	9012430087300
0.3465			8.800	98.00	55.00	9012430088000
0.3504			8.900	98.00	55.00	9012430089000
0.3543			9.000	98.00	55.00	9012430090000
0.3583			9.100	102.00	58.00	9012430091000

Dec. inch	Fract. inch	Wire / letter	Diameter (d1) mm	l1 mm	l2 mm	EDP #
0.3594	23/64		9.130	102.00	58.00	9012430091300
0.3622			9.200	102.00	58.00	9012430092000
0.3661			9.300	102.00	58.00	9012430093000
0.3701			9.400	102.00	58.00	9012430094000
0.3740			9.500	102.00	58.00	9012430095000
0.3748	3/8		9.520	105.00	60.00	9012430095200
0.3780			9.600	105.00	60.00	9012430096000
0.3819			9.700	105.00	60.00	9012430097000
0.3858		W	9.800	105.00	60.00	9012430098000
0.3898			9.900	105.00	60.00	9012430099000
0.3906	25/64		9.920	105.00	60.00	9012430099200
0.3937			10.000	105.00	60.00	9012430100000
0.3976			10.100	112.00	66.00	9012430101000
0.4016			10.200	112.00	66.00	9012430102000
0.4055			10.300	112.00	66.00	9012430103000
0.4063	13/32		10.320	112.00	66.00	9012430103200
0.4094			10.400	112.00	66.00	9012430104000
0.4134			10.500	112.00	66.00	9012430105000
0.4173			10.600	114.00	68.00	9012430106000
0.4213			10.700	114.00	68.00	9012430107000
0.4220	27/64		10.720	114.00	68.00	9012430107200
0.4252			10.800	114.00	68.00	9012430108000
0.4291			10.900	114.00	68.00	9012430109000
0.4331			11.000	114.00	68.00	9012430110000
0.4370			11.100	118.00	71.00	9012430111000
0.4374	7/16		11.110	118.00	71.00	9012430111100
0.4409			11.200	118.00	71.00	9012430112000
0.4449			11.300	118.00	71.00	9012430113000
0.4488			11.400	118.00	71.00	9012430114000
0.4528			11.500	118.00	71.00	9012430115000
0.4531	29/64		11.510	121.00	73.00	9012430115100
0.4567			11.600	121.00	73.00	9012430116000
0.4606			11.700	121.00	73.00	9012430117000
0.4646			11.800	121.00	73.00	9012430118000
0.4685			11.900	121.00	73.00	9012430119000
0.4689	15/32		11.910	121.00	73.00	9012430119100
0.4724			12.000	121.00	73.00	9012430120000
0.4921			12.500	135.00	76.00	9012430125000
0.5000	1/2		12.700	137.00	78.00	9012430127000
0.5118			13.000	137.00	78.00	9012430130000
0.5315			13.500	144.00	84.00	9012430135000
0.5512			14.000	147.00	86.00	9012430140000
0.5709			14.500	151.00	89.00	9012430145000
0.5906			15.000	153.00	91.00	9012430150000
0.6102			15.500	157.00	94.00	9012430155000
0.6299			16.000	160.00	96.00	9012430160000

Alternative Drill Series:

- #5515 Carbide, RT100, 5xD, 140 U pt, FIREX®
- #5511 Carbide, RT100, 5xD, 140 U pt, FIREX®
- #1183 Carbide, RT100, 5xD, 140 U pt, TiN

5xD



Speeds & Feeds
information pg 462

Series 1452

Three-Flute High Precision Carbide, GS 200 U three-flute high precision, 5xD, self-centering 150° point, standard straight shank, RH helix

Cut / Shank Dia. = h7 tolerance range

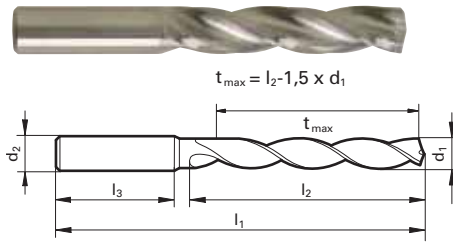

d1 = d2

Application Materials:

-  General Steels/Brass
-  Cast Iron
-  Aluminum & Alloys

Twist Drills



Dec. inch	Fract. inch	Wire / letter	Diameter (d1) mm	l1 mm	l2 mm	EDP #
0.1181			3.000	46.00	22.00	9014520030000
0.1201		31	3.050	46.00	22.00	9014520030500
0.1220			3.100	49.00	24.00	9014520031000
0.1248	1/8		3.170	49.00	24.00	9014520031700
0.1260			3.200	49.00	24.00	9014520032000
0.1299			3.300	49.00	24.00	9014520033000
0.1339			3.400	52.00	27.00	9014520034000
0.1358		29	3.450	52.00	27.00	9014520034500
0.1378			3.500	52.00	27.00	9014520035000
0.1406	9/64	28	3.570	52.00	27.00	9014520035700
0.1417			3.600	52.00	27.00	9014520036000
0.1457			3.700	52.00	27.00	9014520037000
0.1496		25	3.800	55.00	30.00	9014520038000
0.1535			3.900	55.00	30.00	9014520039000
0.1563	5/32		3.970	55.00	30.00	9014520039700
0.1575			4.000	55.00	30.00	9014520040000
0.1614			4.100	55.00	30.00	9014520041000
0.1654			4.200	55.00	30.00	9014520042000
0.1693		18	4.300	58.00	32.00	9014520043000
0.1720	11/64		4.370	58.00	32.00	9014520043700
0.1732			4.400	58.00	32.00	9014520044000
0.1772		16	4.500	58.00	32.00	9014520045000
0.1811			4.600	58.00	32.00	9014520046000
0.1850		13	4.700	58.00	32.00	9014520047000
0.1874	3/16		4.760	62.00	35.00	9014520047600
0.1890		12	4.800	62.00	35.00	9014520048000
0.1929			4.900	62.00	35.00	9014520049000
0.1969			5.000	62.00	35.00	9014520050000
0.2008			5.100	62.00	35.00	9014520051000
0.2031	13/64		5.160	62.00	35.00	9014520051600
0.2047			5.200	62.00	35.00	9014520052000
0.2087			5.300	62.00	35.00	9014520053000
0.2126			5.400	66.00	39.00	9014520054000
0.2165			5.500	66.00	39.00	9014520055000
0.2189	7/32		5.560	66.00	39.00	9014520055600
0.2205			5.600	66.00	39.00	9014520056000
0.2244			5.700	66.00	39.00	9014520057000
0.2283			5.800	66.00	39.00	9014520058000
0.2323			5.900	66.00	39.00	9014520059000
0.2343	15/64		5.950	66.00	39.00	9014520059500
0.2362			6.000	66.00	39.00	9014520060000
0.2402			6.100	70.00	42.00	9014520061000
0.2421		C	6.150	70.00	42.00	9014520061500
0.2441			6.200	70.00	42.00	9014520062000
0.2480			6.300	70.00	42.00	9014520063000
0.2500	1/4	E	6.350	70.00	42.00	9014520063500
0.2520			6.400	70.00	42.00	9014520064000
0.2559			6.500	70.00	42.00	9014520065000
0.2598			6.600	70.00	42.00	9014520066000
0.2638			6.700	70.00	42.00	9014520067000
0.2657	17/64	H	6.750	74.00	45.00	9014520067500
0.2677			6.800	74.00	45.00	9014520068000
0.2717		I	6.900	74.00	45.00	9014520069000
0.2756			7.000	74.00	45.00	9014520070000

Dec. inch	Fract. inch	Wire / letter	Diameter (d1) mm	l1 mm	l2 mm	EDP #
0.2795			7.100	74.00	45.00	9014520071000
0.2811	9/32	K	7.140	74.00	45.00	9014520071400
0.2835			7.200	74.00	45.00	9014520072000
0.2874			7.300	74.00	45.00	9014520073000
0.2913			7.400	74.00	45.00	9014520074000
0.2953			7.500	74.00	45.00	9014520075000
0.2969	19/64		7.540	79.00	48.00	9014520075400
0.2992			7.600	79.00	48.00	9014520076000
0.3031			7.700	79.00	48.00	9014520077000
0.3071			7.800	79.00	48.00	9014520078000
0.3110			7.900	79.00	48.00	9014520079000
0.3126	5/16		7.940	79.00	48.00	9014520079400
0.3150			8.000	79.00	48.00	9014520080000
0.3189			8.100	79.00	48.00	9014520081000
0.3228		P	8.200	79.00	48.00	9014520082000
0.3268			8.300	79.00	48.00	9014520083000
0.3280	21/64		8.330	79.00	48.00	9014520083300
0.3307			8.400	79.00	48.00	9014520084000
0.3319		Q	8.430	79.00	48.00	9014520084300
0.3346			8.500	79.00	48.00	9014520085000
0.3386			8.600	84.00	52.00	9014520086000
0.3425			8.700	84.00	52.00	9014520087000
0.3437	11/32		8.730	84.00	52.00	9014520087300
0.3465			8.800	84.00	52.00	9014520088000
0.3504			8.900	84.00	52.00	9014520089000
0.3543			9.000	84.00	52.00	9014520090000
0.3583			9.100	84.00	52.00	9014520091000
0.3594	23/64		9.130	84.00	52.00	9014520091300
0.3622			9.200	84.00	52.00	9014520092000
0.3661			9.300	84.00	52.00	9014520093000
0.3701			9.400	84.00	52.00	9014520094000
0.3740			9.500	84.00	52.00	9014520095000
0.3748	3/8		9.520	89.00	55.00	9014520095200
0.3780			9.600	89.00	55.00	9014520096000
0.3819			9.700	89.00	55.00	9014520097000
0.3858		W	9.800	89.00	55.00	9014520098000
0.3898			9.900	89.00	55.00	9014520099000
0.3906	25/64		9.920	89.00	55.00	9014520099200
0.3937			10.000	89.00	55.00	9014520100000
0.3976			10.100	89.00	55.00	9014520101000
0.4016			10.200	89.00	55.00	9014520102000
0.4055			10.300	89.00	55.00	9014520103000
0.4063	13/32		10.320	89.00	55.00	9014520103200
0.4094			10.400	89.00	55.00	9014520104000
0.4134			10.500	89.00	55.00	9014520105000
0.4173			10.600	89.00	55.00	9014520106000
0.4213			10.700	95.00	60.00	9014520107000
0.4220	27/64		10.720	95.00	60.00	9014520107200
0.4252			10.800	95.00	60.00	9014520108000
0.4291			10.900	95.00	60.00	9014520109000
0.4331			11.000	95.00	60.00	9014520110000
0.4370			11.100	95.00	60.00	9014520111000
0.4374	7/16		11.110	95.00	60.00	9014520111100
0.4409			11.200	95.00	60.00	9014520112000

*Items listed in red are non-stocked items, and may take 2 - 6 weeks to receive

Series 1452

Speeds & Feeds information pg 462

Dec. inch	Diameter (d1)		11 mm	12 mm	EDP #	
	Fract. inch	Wire / letter				
0.4449			11.300	95.00	60.00	9014520113000
0.4488			11.400	95.00	60.00	9014520114000
0.4528			11.500	95.00	60.00	9014520115000
0.4531	29/64		11.510	95.00	60.00	9014520115100
0.4567			11.600	95.00	60.00	9014520116000
0.4606			11.700	95.00	60.00	9014520117000
0.4646			11.800	95.00	60.00	9014520118000
0.4685			11.900	102.00	65.00	9014520119000
0.4689	15/32		11.910	102.00	65.00	9014520119100
0.4724			12.000	102.00	65.00	9014520120000
0.4764			12.100	102.00	65.00	9014520121000
0.4803			12.200	102.00	65.00	9014520122000
0.4843	31/64		12.300	102.00	65.00	9014520123000
0.4882			12.400	102.00	65.00	9014520124000
0.4921			12.500	102.00	65.00	9014520125000
0.4961			12.600	102.00	65.00	9014520126000
0.5000	1/2		12.700	102.00	65.00	9014520127000
0.5039			12.800	102.00	65.00	9014520128000
0.5079			12.900	102.00	65.00	9014520129000
0.5118			13.000	102.00	65.00	9014520130000
0.5157	33/64		13.100	102.00	65.00	9014520131000
0.5197			13.200	102.00	65.00	9014520132000
0.5236			13.300	107.00	66.00	9014520133000
0.5276			13.400	107.00	66.00	9014520134000
0.5315			13.500	107.00	66.00	9014520135000
0.5354			13.600	107.00	66.00	9014520136000
0.5394			13.700	107.00	66.00	9014520137000
0.5433			13.800	107.00	66.00	9014520138000
0.5472			13.900	107.00	66.00	9014520139000
0.5512			14.000	107.00	66.00	9014520140000
0.5551			14.100	111.00	70.00	9014520141000
0.5591			14.200	111.00	70.00	9014520142000
0.5626	9/16		14.290	111.00	70.00	9014520142900
0.5630			14.300	111.00	70.00	9014520143000
0.5669			14.400	111.00	70.00	9014520144000

Dec. inch	Diameter (d1)		11 mm	12 mm	EDP #	
	Fract. inch	Wire / letter				
0.5709			14.500	111.00	70.00	9014520145000
0.5748			14.600	111.00	70.00	9014520146000
0.5787			14.700	111.00	70.00	9014520147000
0.5827			14.800	111.00	70.00	9014520148000
0.5866			14.900	111.00	70.00	9014520149000
0.5906			15.000	111.00	70.00	9014520150000
0.5945			15.100	115.00	73.00	9014520151000
0.5984			15.200	115.00	73.00	9014520152000
0.6024			15.300	115.00	73.00	9014520153000
0.6063			15.400	115.00	73.00	9014520154000
0.6102			15.500	115.00	73.00	9014520155000
0.6142			15.600	115.00	73.00	9014520156000
0.6181			15.700	115.00	73.00	9014520157000
0.6220			15.800	115.00	73.00	9014520158000
0.6248	5/8		15.870	115.00	73.00	9014520158700
0.6260			15.900	115.00	73.00	9014520159000
0.6299			16.000	115.00	73.00	9014520160000
0.6406	41/64		16.270	115.00	73.00	9014520162700
0.6496			16.500	119.00	73.00	9014520165000
0.6563	21/32		16.670	119.00	73.00	9014520166700
0.6693			17.000	119.00	73.00	9014520170000
0.6874	11/16		17.460	123.00	76.00	9014520174600
0.6890			17.500	123.00	76.00	9014520175000
0.7087			18.000	123.00	76.00	9014520180000
0.7283			18.500	127.00	76.00	9014520185000
0.7480			19.000	127.00	76.00	9014520190000
0.7500	3/4		19.050	131.00	79.00	9014520190500
0.7677			19.500	131.00	79.00	9014520195000
0.7874			20.000	131.00	79.00	9014520200000

Alternative Drill Series:

#609 Carbide, GS200, 5xD, 150 U pt, TiN
 #5518 Carbide, GS200, 5xD, 150 G pt, Bright

5xD

Series 1662

Application Materials:



TiN coated



Coolant Through



Reinforced Straight Shank

RT 100 F High Penetration

Carbide, RT 100 F high penetration, 5xD, self-centering
140° SF point, reinforced straight shank, RH helix

Cut Dia. = m7 tolerance range, Shank Dia. = h6

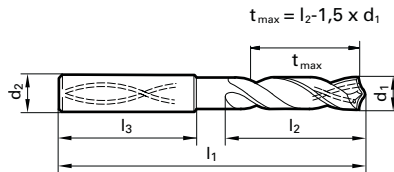

- General Steels/Brass
- Universal Steels
- Stainless Steels
- Cast Iron
- Aluminum & Alloys

Speeds & Feeds
information pg 462

Dec. inch	Fract. inch	Wire / letter	Diameter (d1) mm	d2 mm	l1 mm	l2 mm	EDP #
0.1181			3.000	6.000	66.00	28.00	9016620030000
0.1220			3.100	6.000	66.00	28.00	9016620031000
0.1248	1/8		3.170	6.000	66.00	28.00	9016620031700
0.1260			3.200	6.000	66.00	28.00	9016620032000
0.1299			3.300	6.000	66.00	28.00	9016620033000
0.1339			3.400	6.000	66.00	28.00	9016620034000
0.1378			3.500	6.000	66.00	28.00	9016620035000
0.1406	9/64		3.570	6.000	66.00	28.00	9016620035700
0.1417			3.600	6.000	66.00	28.00	9016620036000
0.1457			3.700	6.000	66.00	28.00	9016620037000
0.1496			3.800	6.000	74.00	36.00	9016620038000
0.1535			3.900	6.000	74.00	36.00	9016620039000
0.1563	5/32		3.970	6.000	74.00	36.00	9016620039700
0.1575			4.000	6.000	74.00	36.00	9016620040000
0.1614			4.100	6.000	74.00	36.00	9016620041000
0.1654			4.200	6.000	74.00	36.00	9016620042000
0.1693		18	4.300	6.000	74.00	36.00	9016620043000
0.1720	11/64		4.370	6.000	74.00	36.00	9016620043700
0.1732			4.400	6.000	74.00	36.00	9016620044000
0.1772		16	4.500	6.000	74.00	36.00	9016620045000
0.1811			4.600	6.000	74.00	36.00	9016620046000
0.1831			4.650	6.000	74.00	36.00	9016620046500
0.1850		13	4.700	6.000	74.00	36.00	9016620047000
0.1874	3/16		4.760	6.000	82.00	44.00	9016620047600
0.1890		12	4.800	6.000	82.00	44.00	9016620048000
0.1929			4.900	6.000	82.00	44.00	9016620049000
0.1969			5.000	6.000	82.00	44.00	9016620050000
0.2008			5.100	6.000	82.00	44.00	9016620051000
0.2031	13/64		5.160	6.000	82.00	44.00	9016620051600
0.2047			5.200	6.000	82.00	44.00	9016620052000
0.2087			5.300	6.000	82.00	44.00	9016620053000
0.2126			5.400	6.000	82.00	44.00	9016620054000
0.2165			5.500	6.000	82.00	44.00	9016620055000
0.2185			5.550	6.000	82.00	44.00	9016620055500
0.2189	7/32		5.560	6.000	82.00	44.00	9016620055600
0.2205			5.600	6.000	82.00	44.00	9016620056000
0.2224			5.650	6.000	82.00	44.00	9016620056500
0.2244			5.700	6.000	82.00	44.00	9016620057000
0.2283			5.800	6.000	82.00	44.00	9016620058000
0.2323			5.900	6.000	82.00	44.00	9016620059000
0.2343	15/64		5.950	6.000	82.00	44.00	9016620059500
0.2362			6.000	6.000	82.00	44.00	9016620060000
0.2402			6.100	8.000	91.00	53.00	9016620061000
0.2441			6.200	8.000	91.00	53.00	9016620062000
0.2480			6.300	8.000	91.00	53.00	9016620063000
0.2500	1/4	E	6.350	8.000	91.00	53.00	9016620063500
0.2520			6.400	8.000	91.00	53.00	9016620064000
0.2559			6.500	8.000	91.00	53.00	9016620065000
0.2598			6.600	8.000	91.00	53.00	9016620066000
0.2638			6.700	8.000	91.00	53.00	9016620067000
0.2657	17/64	H	6.750	8.000	91.00	53.00	9016620067500
0.2677			6.800	8.000	91.00	53.00	9016620068000
0.2717		I	6.900	8.000	91.00	53.00	9016620069000

Dec. inch	Fract. inch	Wire / letter	Diameter (d1) mm	d2 mm	l1 mm	l2 mm	EDP #
0.2756			7.000	8.000	91.00	53.00	9016620070000
0.2795			7.100	8.000	91.00	53.00	9016620071000
0.2811	9/32	K	7.140	8.000	91.00	53.00	9016620071400
0.2835			7.200	8.000	91.00	53.00	9016620072000
0.2874			7.300	8.000	91.00	53.00	9016620073000
0.2913			7.400	8.000	91.00	53.00	9016620074000
0.2953			7.500	8.000	91.00	53.00	9016620075000
0.2969	19/64		7.540	8.000	91.00	53.00	9016620075400
0.2992			7.600	8.000	91.00	53.00	9016620076000
0.3031			7.700	8.000	91.00	53.00	9016620077000
0.3071			7.800	8.000	91.00	53.00	9016620078000
0.3110			7.900	8.000	91.00	53.00	9016620079000
0.3126	5/16		7.940	8.000	91.00	53.00	9016620079400
0.3150			8.000	8.000	91.00	53.00	9016620080000
0.3189			8.100	10.000	103.00	61.00	9016620081000
0.3228		P	8.200	10.000	103.00	61.00	9016620082000
0.3268			8.300	10.000	103.00	61.00	9016620083000
0.3280	21/64		8.330	10.000	103.00	61.00	9016620083300
0.3307			8.400	10.000	103.00	61.00	9016620084000
0.3346			8.500	10.000	103.00	61.00	9016620085000
0.3386			8.600	10.000	103.00	61.00	9016620086000
0.3425			8.700	10.000	103.00	61.00	9016620087000
0.3437	11/32		8.730	10.000	103.00	61.00	9016620087300
0.3465			8.800	10.000	103.00	61.00	9016620088000
0.3504			8.900	10.000	103.00	61.00	9016620089000
0.3543			9.000	10.000	103.00	61.00	9016620090000
0.3583			9.100	10.000	103.00	61.00	9016620091000
0.3594	23/64		9.130	10.000	103.00	61.00	9016620091300
0.3622			9.200	10.000	103.00	61.00	9016620092000
0.3642			9.250	10.000	103.00	61.00	9016620092500
0.3661			9.300	10.000	103.00	61.00	9016620093000
0.3701			9.400	10.000	103.00	61.00	9016620094000
0.3740			9.500	10.000	103.00	61.00	9016620095000
0.3748	3/8		9.520	10.000	103.00	61.00	9016620095200
0.3780			9.600	10.000	103.00	61.00	9016620096000
0.3819			9.700	10.000	103.00	61.00	9016620097000
0.3858		W	9.800	10.000	103.00	61.00	9016620098000
0.3898			9.900	10.000	103.00	61.00	9016620099000
0.3906	25/64		9.920	10.000	103.00	61.00	9016620099200
0.3937			10.000	10.000	103.00	61.00	9016620100000
0.3976			10.100	12.000	118.00	71.00	9016620101000
0.4016			10.200	12.000	118.00	71.00	9016620102000
0.4063	13/32		10.320	12.000	118.00	71.00	9016620103200
0.4134			10.500	12.000	118.00	71.00	9016620105000
0.4213			10.700	12.000	118.00	71.00	9016620107000
0.4220	27/64		10.720	12.000	118.00	71.00	9016620107200
0.4252			10.800	12.000	118.00	71.00	9016620108000
0.4331			11.000	12.000	118.00	71.00	9016620110000
0.4370			11.100	12.000	118.00	71.00	9016620111000
0.4374	7/16		11.110	12.000	118.00	71.00	9016620111100
0.4409			11.200	12.000	118.00	71.00	9016620112000
0.4449			11.300	12.000	118.00	71.00	9016620113000
0.4488			11.400	12.000	118.00	71.00	9016620114000

*Items listed in red are non-stocked items, and may take 2 - 6 weeks to receive

Series 1662

Speeds & Feeds information pg 462

Twist Drills

Dec. inch	Diameter (d1)		d2 mm	l1 mm	l2 mm	EDP #	
	Fract. inch	Wire / letter					
0.4528			11.500	12.000	118.00	71.00	9016620115000
0.4531	29/64		11.510	12.000	118.00	71.00	9016620115100
0.4606			11.700	12.000	118.00	71.00	9016620117000
0.4646			11.800	12.000	118.00	71.00	9016620118000
0.4689	15/32		11.910	12.000	118.00	71.00	9016620119100
0.4724			12.000	12.000	118.00	71.00	9016620120000
0.4764			12.100	14.000	124.00	77.00	9016620121000
0.4803			12.200	14.000	124.00	77.00	9016620122000
0.4843	31/64		12.300	14.000	124.00	77.00	9016620123000
0.4921			12.500	14.000	124.00	77.00	9016620125000
0.5000	1/2		12.700	14.000	124.00	77.00	9016620127000
0.5039			12.800	14.000	124.00	77.00	9016620128000
0.5079			12.900	14.000	124.00	77.00	9016620129000
0.5118			13.000	14.000	124.00	77.00	9016620130000
0.5196			13.200	14.000	124.00	77.00	9016620132000
0.5236			13.300	14.000	124.00	77.00	9016620133000
0.5315			13.500	14.000	124.00	77.00	9016620135000
0.5433			13.800	14.000	124.00	77.00	9016620138000
0.5512			14.000	14.000	124.00	77.00	9016620140000
0.5551			14.100	16.000	133.00	83.00	9016620141000

Dec. inch	Diameter (d1)		d2 mm	l1 mm	l2 mm	EDP #	
	Fract. inch	Wire / letter					
0.5709			14.500	16.000	133.00	83.00	9016620145000
0.5748			14.600	16.000	133.00	83.00	9016620146000
0.5906			15.000	16.000	133.00	83.00	9016620150000
0.6024			15.300	16.000	133.00	83.00	9016620153000
0.6102			15.500	16.000	133.00	83.00	9016620155000
0.6220			15.800	16.000	133.00	83.00	9016620158000
0.6299			16.000	16.000	133.00	83.00	9016620160000
0.6496			16.500	18.000	143.00	93.00	9016620165000
0.6693			17.000	18.000	143.00	93.00	9016620170000
0.6890			17.500	18.000	143.00	93.00	9016620175000
0.7087			18.000	18.000	143.00	93.00	9016620180000
0.7480			19.000	20.000	143.00	93.00	9016620190000
0.7874			20.000	20.000	153.00	101.00	9016620200000

Alternative Drill Series:

- #5511 Carbide, RT100, 5xD, 140 U pt, FIREX®
- #2479 Carbide, RT100, 5xD, 140 U pt, nano-FIREX®
- #8511 Carbide, RT100VA, 5xD, 140 VA pt, nano-A

3xD



TiN coated



External Coolant



Straight Shank

Speeds & Feeds
information pg 463

Series 1702

RT 100 F High Penetration

Carbide, RT 100 F high penetration, 3xD, self-centering
140° SF point, standard straight shank, RH helix

Cut Dia. = m7 tolerance range, Shank Dia. = h6

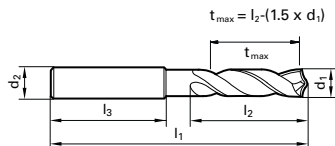

d1 = d2

Application Materials:

- General Steels/Brass
- Universal Steels
- Stainless Steels
- Cast Iron
- Aluminum & Alloys

Twist Drills

Diameter (d1)						
Dec. inch	Fract. inch	Wire / letter	mm	l1 mm	l2 mm	EDP #
0.1181			3.000	46.00	16.00	9017020030000
0.1220			3.100	49.00	18.00	9017020031000
0.1248	1/8		3.170	49.00	18.00	9017020031700
0.1260			3.200	49.00	18.00	9017020032000
0.1299			3.300	49.00	18.00	9017020033000
0.1339			3.400	52.00	20.00	9017020034000
0.1378			3.500	52.00	20.00	9017020035000
0.1406	9/64	28	3.570	52.00	20.00	9017020035700
0.1417			3.600	52.00	20.00	9017020036000
0.1457			3.700	52.00	20.00	9017020037000
0.1496		25	3.800	55.00	22.00	9017020038000
0.1535			3.900	55.00	22.00	9017020039000
0.1563	5/32		3.970	55.00	22.00	9017020039700
0.1575			4.000	55.00	22.00	9017020040000
0.1614			4.100	55.00	22.00	9017020041000
0.1654			4.200	55.00	22.00	9017020042000
0.1693		18	4.300	58.00	24.00	9017020043000
0.1720	11/64		4.370	58.00	24.00	9017020043700
0.1732			4.400	58.00	24.00	9017020044000
0.1772		16	4.500	58.00	24.00	9017020045000
0.1811			4.600	58.00	24.00	9017020046000
0.1850		13	4.700	58.00	24.00	9017020047000
0.1874	3/16		4.760	62.00	26.00	9017020047600
0.1890		12	4.800	62.00	26.00	9017020048000
0.1929			4.900	62.00	26.00	9017020049000
0.1969			5.000	62.00	26.00	9017020050000
0.2008			5.100	62.00	26.00	9017020051000
0.2031	13/64		5.160	62.00	26.00	9017020051600
0.2047			5.200	62.00	26.00	9017020052000
0.2087			5.300	62.00	26.00	9017020053000
0.2126			5.400	66.00	28.00	9017020054000
0.2165			5.500	66.00	28.00	9017020055000
0.2189	7/32		5.560	66.00	28.00	9017020055600
0.2205			5.600	66.00	28.00	9017020056000
0.2244			5.700	66.00	28.00	9017020057000
0.2283			5.800	66.00	28.00	9017020058000
0.2323			5.900	66.00	28.00	9017020059000
0.2343	15/64		5.950	66.00	28.00	9017020059500
0.2362			6.000	66.00	28.00	9017020060000
0.2402			6.100	70.00	31.00	9017020061000
0.2441			6.200	70.00	31.00	9017020062000
0.2480			6.300	70.00	31.00	9017020063000
0.2500	1/4	E	6.350	70.00	31.00	9017020063500
0.2520			6.400	70.00	31.00	9017020064000
0.2559			6.500	70.00	31.00	9017020065000
0.2598			6.600	70.00	31.00	9017020066000
0.2638			6.700	70.00	31.00	9017020067000
0.2657	17/64	H	6.750	74.00	34.00	9017020067500
0.2677			6.800	74.00	34.00	9017020068000
0.2717		I	6.900	74.00	34.00	9017020069000
0.2756			7.000	74.00	34.00	9017020070000
0.2795			7.100	74.00	34.00	9017020071000
0.2811	9/32	K	7.140	74.00	34.00	9017020071400
0.2835			7.200	74.00	34.00	9017020072000
0.2874			7.300	74.00	34.00	9017020073000
0.2913			7.400	74.00	34.00	9017020074000

Diameter (d1)						
Dec. inch	Fract. inch	Wire / letter	mm	l1 mm	l2 mm	EDP #
0.2953			7.500	74.00	34.00	9017020075000
0.2969	19/64		7.540	79.00	37.00	9017020075400
0.2992			7.600	79.00	37.00	9017020076000
0.3031			7.700	79.00	37.00	9017020077000
0.3071			7.800	79.00	37.00	9017020078000
0.3110			7.900	79.00	37.00	9017020079000
0.3126	5/16		7.940	79.00	37.00	9017020079400
0.3150			8.000	79.00	37.00	9017020080000
0.3189			8.100	79.00	37.00	9017020081000
0.3228		P	8.200	79.00	37.00	9017020082000
0.3268			8.300	79.00	37.00	9017020083000
0.3280	21/64		8.330	79.00	37.00	9017020083300
0.3307			8.400	79.00	37.00	9017020084000
0.3346			8.500	79.00	37.00	9017020085000
0.3386			8.600	84.00	40.00	9017020086000
0.3425			8.700	84.00	40.00	9017020087000
0.3437	11/32		8.730	84.00	40.00	9017020087300
0.3465			8.800	84.00	40.00	9017020088000
0.3504			8.900	84.00	40.00	9017020089000
0.3543			9.000	84.00	40.00	9017020090000
0.3583			9.100	84.00	40.00	9017020091000
0.3594	23/64		9.130	84.00	40.00	9017020091300
0.3622			9.200	84.00	40.00	9017020092000
0.3661			9.300	84.00	40.00	9017020093000
0.3701			9.400	84.00	40.00	9017020094000
0.3740			9.500	84.00	40.00	9017020095000
0.3748	3/8		9.520	89.00	43.00	9017020095200
0.3780			9.600	89.00	43.00	9017020096000
0.3819			9.700	89.00	43.00	9017020097000
0.3858		W	9.800	89.00	43.00	9017020098000
0.3898			9.900	89.00	43.00	9017020099000
0.3906	25/64		9.920	89.00	43.00	9017020099200
0.3937			10.000	89.00	43.00	9017020100000
0.4016			10.200	89.00	43.00	9017020102000
0.4055			10.300	89.00	43.00	9017020103000
0.4063	13/32		10.320	89.00	43.00	9017020103200
0.4134			10.500	89.00	43.00	9017020105000
0.4213			10.700	89.00	43.00	9017020107000
0.4220	27/64		10.720	95.00	47.00	9017020107200
0.4252			10.800	95.00	47.00	9017020108000
0.4331			11.000	95.00	47.00	9017020110000
0.4374	7/16		11.110	95.00	47.00	9017020111100
0.4528			11.500	95.00	47.00	9017020115000
0.4531	29/64		11.510	95.00	47.00	9017020115100
0.4646			11.800	102.00	51.00	9017020118000
0.4689	15/32		11.910	102.00	51.00	9017020119100
0.4724			12.000	102.00	51.00	9017020120000
0.4843	31/64		12.300	102.00	51.00	9017020123000
0.4921			12.500	102.00	51.00	9017020125000
0.5000	1/2		12.700	102.00	51.00	9017020127000
0.5118			13.000	102.00	51.00	9017020130000
0.5315			13.500	107.00	54.00	9017020135000
0.5512			14.000	107.00	54.00	9017020140000
0.5709			14.500	111.00	56.00	9017020145000
0.5906			15.000	111.00	56.00	9017020150000

5xD

Series 2458

Application Materials:

Twist Drills



FIREX® Coated



External Coolant



Straight Shank

Speeds & Feeds
information pg 463

Type Ti

Cobalt, Type Ti, jobber length, self-centering 130° split point, web thinned >1.0mm dia., standard straight shank, RH helix

Cut / Shank Dia. = h8 tolerance range

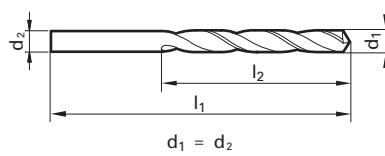

- Stainless Steels
- Hardened Materials
- Cast Iron
- Ti & Ni Alloys
- Universal Steels

Dec. inch	Diameter (d1)		l1 mm	l2 mm	EDP #
	Fract. inch	Wire / letter			
0.0157	1/64		20.00	5.00	9024580004000
0.0394			34.00	12.00	9024580010000
0.0433			36.00	14.00	9024580011000
0.0469	3/64		38.00	16.00	9024580011900
0.0472			38.00	16.00	9024580012000
0.0512			38.00	16.00	9024580013000
0.0551		54	40.00	18.00	9024580014000
0.0591			40.00	18.00	9024580015000
0.0598			43.00	20.00	9024580015200
0.0602			43.00	20.00	9024580015300
0.0626	1/16		43.00	20.00	9024580015900
0.0630			43.00	20.00	9024580016000
0.0650			43.00	20.00	9024580016500
0.0669		51	43.00	20.00	9024580017000
0.0709			46.00	22.00	9024580018000
0.0748			46.00	22.00	9024580019000
0.0780	5/64		49.00	24.00	9024580019800
0.0787			49.00	24.00	9024580020000
0.0807			49.00	24.00	9024580020500
0.0827			49.00	24.00	9024580021000
0.0866			53.00	27.00	9024580022000
0.0906			53.00	27.00	9024580023000
0.0933		42	57.00	30.00	9024580023700
0.0937	3/32		57.00	30.00	9024580023800
0.0945			57.00	30.00	9024580024000
0.0984			57.00	30.00	9024580025000
0.1024			57.00	30.00	9024580026000
0.1063			61.00	33.00	9024580027000
0.1083			61.00	33.00	9024580027500
0.1094	7/64		61.00	33.00	9024580027800
0.1102			61.00	33.00	9024580028000
0.1142			61.00	33.00	9024580029000
0.1181			61.00	33.00	9024580030000
0.1220			65.00	36.00	9024580031000
0.1248	1/8		65.00	36.00	9024580031700
0.1260			65.00	36.00	9024580032000
0.1280			65.00	36.00	9024580032500
0.1299			65.00	36.00	9024580033000
0.1339			70.00	39.00	9024580034000
0.1378			70.00	39.00	9024580035000
0.1406	9/64	28	70.00	39.00	9024580035700
0.1417			70.00	39.00	9024580036000
0.1457			70.00	39.00	9024580037000
0.1496		25	75.00	43.00	9024580038000
0.1535			75.00	43.00	9024580039000
0.1563	5/32		75.00	43.00	9024580039700
0.1575			75.00	43.00	9024580040000
0.1614			75.00	43.00	9024580041000
0.1634			75.00	43.00	9024580041500
0.1654			75.00	43.00	9024580042000
0.1661			75.00	43.00	9024580042200
0.1693		18	80.00	47.00	9024580043000
0.1720	11/64		80.00	47.00	9024580043700
0.1732			80.00	47.00	9024580044000

Dec. inch	Diameter (d1)		l1 mm	l2 mm	EDP #
	Fract. inch	Wire / letter			
0.1772		16	80.00	47.00	9024580045000
0.1811			80.00	47.00	9024580046000
0.1850		13	80.00	47.00	9024580047000
0.1874	3/16		86.00	52.00	9024580047600
0.1890		12	86.00	52.00	9024580048000
0.1929			86.00	52.00	9024580049000
0.1969			86.00	52.00	9024580050000
0.1988			86.00	52.00	9024580050500
0.2008			86.00	52.00	9024580051000
0.2031	13/64		86.00	52.00	9024580051600
0.2047			86.00	52.00	9024580052000
0.2087			86.00	52.00	9024580053000
0.2126			93.00	57.00	9024580054000
0.2165			93.00	57.00	9024580055000
0.2189	7/32		93.00	57.00	9024580055600
0.2205			93.00	57.00	9024580056000
0.2244			93.00	57.00	9024580057000
0.2283			93.00	57.00	9024580058000
0.2323			93.00	57.00	9024580059000
0.2343	15/64		93.00	57.00	9024580059500
0.2362			93.00	57.00	9024580060000
0.2402			101.00	63.00	9024580061000
0.2441			101.00	63.00	9024580062000
0.2480			101.00	63.00	9024580063000
0.2500	1/4	E	101.00	63.00	9024580063500
0.2520			101.00	63.00	9024580064000
0.2559			101.00	63.00	9024580065000
0.2598			101.00	63.00	9024580066000
0.2638			101.00	63.00	9024580067000
0.2657	17/64	H	109.00	69.00	9024580067500
0.2677			109.00	69.00	9024580068000
0.2717		I	109.00	69.00	9024580069000
0.2756			109.00	69.00	9024580070000
0.2795			109.00	69.00	9024580071000
0.2811	9/32	K	109.00	69.00	9024580071400
0.2835			109.00	69.00	9024580072000
0.2874			109.00	69.00	9024580073000
0.2913			109.00	69.00	9024580074000
0.2953			109.00	69.00	9024580075000
0.2969	19/64		117.00	75.00	9024580075400
0.2992			117.00	75.00	9024580076000
0.3031			117.00	75.00	9024580077000
0.3071			117.00	75.00	9024580078000
0.3110			117.00	75.00	9024580079000
0.3126	5/16		117.00	75.00	9024580079400
0.3150			117.00	75.00	9024580080000
0.3189			117.00	75.00	9024580081000
0.3228		P	117.00	75.00	9024580082000
0.3268			117.00	75.00	9024580083000
0.3280	21/64		117.00	75.00	9024580083300
0.3307			117.00	75.00	9024580084000
0.3346			117.00	75.00	9024580085000
0.3386			125.00	81.00	9024580086000
0.3425			125.00	81.00	9024580087000

Series 2458

Speeds & Feeds information pg 463

Dec. inch	Diameter (d1)		I1 mm	I2 mm	EDP #	
	Fract. inch	Wire / letter				
0.3437	11/32		8.730	125.00	81.00	9024580087300
0.3465			8.800	125.00	81.00	9024580088000
0.3504			8.900	125.00	81.00	9024580089000
0.3543			9.000	125.00	81.00	9024580090000
0.3583			9.100	125.00	81.00	9024580091000
0.3594	23/64		9.130	125.00	81.00	9024580091300
0.3622			9.200	125.00	81.00	9024580092000
0.3661			9.300	125.00	81.00	9024580093000
0.3701			9.400	125.00	81.00	9024580094000
0.3740			9.500	125.00	81.00	9024580095000
0.3748	3/8		9.520	133.00	87.00	9024580095200
0.3780			9.600	133.00	87.00	9024580096000
0.3819			9.700	133.00	87.00	9024580097000
0.3858		W	9.800	133.00	87.00	9024580098000
0.3898			9.900	133.00	87.00	9024580099000
0.3906	25/64		9.920	133.00	87.00	9024580099200
0.3937			10.000	133.00	87.00	9024580100000
0.3976			10.100	133.00	87.00	9024580101000
0.4016			10.200	133.00	87.00	9024580102000
0.4055			10.300	133.00	87.00	9024580103000
0.4063	13/32		10.320	133.00	87.00	9024580103200
0.4094			10.400	133.00	87.00	9024580104000
0.4134			10.500	133.00	87.00	9024580105000
0.4220	27/64		10.720	142.00	94.00	9024580107200

Dec. inch	Diameter (d1)		I1 mm	I2 mm	EDP #	
	Fract. inch	Wire / letter				
0.4252			10.800	142.00	94.00	9024580108000
0.4331			11.000	142.00	94.00	9024580110000
0.4374	7/16		11.110	142.00	94.00	9024580111100
0.5000			11.200	142.00	94.00	9024580112000
0.5000			11.500	142.00	94.00	9024580115000
0.4531	29/64		11.510	142.00	94.00	9024580115100
0.4689	15/32		11.910	151.00	101.00	9024580119100
0.4724			12.000	151.00	101.00	9024580120000
0.4843	31/64		12.300	151.00	101.00	9024580123000
0.4921			12.500	151.00	101.00	9024580125000
0.5000	1/2		12.700	151.00	101.00	9024580127000
0.5118			13.000	151.00	101.00	9024580130000
0.5157	33/64		13.100	151.00	101.00	9024580131000
0.5311	17/32		13.490	160.00	108.00	9024580134900
0.5512			14.000	160.00	108.00	9024580140000
0.5626	9/16		14.290	169.00	114.00	9024580142900
0.5709			14.500	169.00	114.00	9024580145000
0.5906			15.000	169.00	114.00	9024580150000

Alternative Drill Series:

- #530 PM Cobalt, GT500, 5xD, 130 pt, FIREX®
- #657 Cobalt, Ti, 5xD, 130 pt, TiN
- #605 Cobalt, Ti, 5xD, 130 pt, Bright

*Items listed in red are non-stocked items, and may take 2 - 6 weeks to receive

3xD



FIREX® Coated



External Coolant



Straight Shank

Speeds & Feeds
information pg 464

Series 2463

General Purpose

Carbide, general purpose (Type N), stub length,
118° faceted point, standard straight shank, RH helix

Cut / Shank Dia. = h7 tolerance range

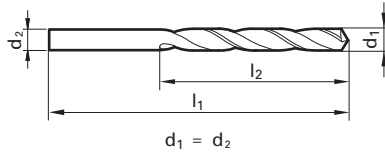

Application Materials:

- General Steels/Brass
- Universal Steels
- Cast Iron

Dec. Inch	Diameter (d1)		l1 mm	l2 mm	EDP #	
	Fract. Inch	Wire / letter				
0.0394			1.000	26.00	6.00	9024630010000
0.0402		60	1.020	26.00	6.00	9024630010200
0.0409		59	1.040	26.00	6.00	9024630010400
0.0421		58	1.070	28.00	7.00	9024630010700
0.0429		57	1.090	28.00	7.00	9024630010900
0.0433			1.100	28.00	7.00	9024630011000
0.0465		56	1.180	28.00	7.00	9024630011800
0.0469		3/64	1.190	30.00	8.00	9024630011900
0.0472			1.200	30.00	8.00	9024630012000
0.0512			1.300	30.00	8.00	9024630013000
0.0520		55	1.320	30.00	8.00	9024630013200
0.0551		54	1.400	32.00	9.00	9024630014000
0.0591			1.500	32.00	9.00	9024630015000
0.0594		53	1.510	34.00	10.00	9024630015100
0.0626		1/16	1.590	34.00	10.00	9024630015900
0.0630			1.600	34.00	10.00	9024630016000
0.0634		52	1.610	34.00	10.00	9024630016100
0.0669		51	1.700	34.00	10.00	9024630017000
0.0701		50	1.780	36.00	11.00	9024630017800
0.0709			1.800	36.00	11.00	9024630018000
0.0728		49	1.850	36.00	11.00	9024630018500
0.0748			1.900	36.00	11.00	9024630019000
0.0760		48	1.930	38.00	12.00	9024630019300
0.0780		5/64	1.980	38.00	12.00	9024630019800
0.0783		47	1.990	38.00	12.00	9024630019900
0.0787			2.000	38.00	12.00	9024630020000
0.0811		46	2.060	38.00	12.00	9024630020600
0.0819		45	2.080	38.00	12.00	9024630020800
0.0827			2.100	38.00	12.00	9024630021000
0.0858		44	2.180	40.00	13.00	9024630021800
0.0866			2.200	40.00	13.00	9024630022000
0.0885			2.250	40.00	13.00	9024630022500
0.0890		43	2.260	40.00	13.00	9024630022600
0.0906			2.300	40.00	13.00	9024630023000
0.0933		42	2.370	43.00	14.00	9024630023700
0.0937		3/32	2.380	43.00	14.00	9024630023800
0.0945			2.400	43.00	14.00	9024630024000
0.0961		41	2.440	43.00	14.00	9024630024400
0.0980		40	2.490	43.00	14.00	9024630024900
0.0984			2.500	43.00	14.00	9024630025000
0.0996		39	2.530	43.00	14.00	9024630025300
0.1016		38	2.580	43.00	14.00	9024630025800
0.1024			2.600	43.00	14.00	9024630026000
0.1039		37	2.640	43.00	14.00	9024630026400
0.1063			2.700	46.00	16.00	9024630027000
0.1067		36	2.710	46.00	16.00	9024630027100
0.1094		7/64	2.780	46.00	16.00	9024630027800
0.1098		35	2.790	46.00	16.00	9024630027900
0.1102			2.800	46.00	16.00	9024630028000
0.1110		34	2.820	46.00	16.00	9024630028200
0.1130		33	2.870	46.00	16.00	9024630028700
0.1142			2.900	46.00	16.00	9024630029000
0.1161		32	2.950	46.00	16.00	9024630029500
0.1181			3.000	46.00	16.00	9024630030000

Dec. Inch	Diameter (d1)		l1 mm	l2 mm	EDP #	
	Fract. Inch	Wire / letter				
0.1201		31	3.050	49.00	18.00	9024630030500
0.1220			3.100	49.00	18.00	9024630031000
0.1248		1/8	3.170	49.00	18.00	9024630031700
0.1260			3.200	49.00	18.00	9024630032000
0.1283		30	3.260	49.00	18.00	9024630032600
0.1299			3.300	49.00	18.00	9024630033000
0.1339			3.400	52.00	20.00	9024630034000
0.1358		29	3.450	52.00	20.00	9024630034500
0.1378			3.500	52.00	20.00	9024630035000
0.1406		9/64	3.570	52.00	20.00	9024630035700
0.1417			3.600	52.00	20.00	9024630036000
0.1441		27	3.660	52.00	20.00	9024630036600
0.1457			3.700	52.00	20.00	9024630037000
0.1469		26	3.730	52.00	20.00	9024630037300
0.1496		25	3.800	55.00	22.00	9024630038000
0.1520		24	3.860	55.00	22.00	9024630038600
0.1535			3.900	55.00	22.00	9024630039000
0.1539		23	3.910	55.00	22.00	9024630039100
0.1563		5/32	3.970	55.00	22.00	9024630039700
0.1571		22	3.990	55.00	22.00	9024630039900
0.1575			4.000	55.00	22.00	9024630040000
0.1591		21	4.040	55.00	22.00	9024630040400
0.1610		20	4.090	55.00	22.00	9024630040900
0.1614			4.100	55.00	22.00	9024630041000
0.1654			4.200	55.00	22.00	9024630042000
0.1661		19	4.220	55.00	22.00	9024630042200
0.1693		18	4.300	58.00	24.00	9024630043000
0.1720		11/64	4.370	58.00	24.00	9024630043700
0.1728		17	4.390	58.00	24.00	9024630043900
0.1732			4.400	58.00	24.00	9024630044000
0.1772		16	4.500	58.00	24.00	9024630045000
0.1799		15	4.570	58.00	24.00	9024630045700
0.1811			4.600	58.00	24.00	9024630046000
0.1819		14	4.620	58.00	24.00	9024630046200
0.1850		13	4.700	58.00	24.00	9024630047000
0.1874		3/16	4.760	62.00	26.00	9024630047600
0.1890		12	4.800	62.00	26.00	9024630048000
0.1909		11	4.850	62.00	26.00	9024630048500
0.1929			4.900	62.00	26.00	9024630049000
0.1937		10	4.920	62.00	26.00	9024630049200
0.1961		9	4.980	62.00	26.00	9024630049800
0.1969			5.000	62.00	26.00	9024630050000
0.1992		8	5.060	62.00	26.00	9024630050600
0.2008			5.100	62.00	26.00	9024630051000
0.2012		7	5.110	62.00	26.00	9024630051100
0.2031		13/64	5.160	62.00	26.00	9024630051600
0.2039		6	5.180	62.00	26.00	9024630051800
0.2047			5.200	62.00	26.00	9024630052000
0.2055		5	5.220	62.00	26.00	9024630052200
0.2087			5.300	62.00	26.00	9024630053000
0.2091		4	5.310	66.00	28.00	9024630053100
0.2126			5.400	66.00	28.00	9024630054000
0.2130		3	5.410	66.00	28.00	9024630054100
0.2165			5.500	66.00	28.00	9024630055000

Series 2463

Speeds & Feeds information pg 464

Twist Drills

Dec. inch	Diameter (d1)			I1 mm	I2 mm	EDP #	
	Fract. inch	Wire / letter	mm				
0.2189	7/32		5.560	66.00	28.00	9024630055600	
0.2205			5.600	66.00	28.00	9024630056000	
0.2209		2		5.610	66.00	28.00	9024630056100
0.2244			5.700	66.00	28.00	9024630057000	
0.2280	1		5.790	66.00	28.00	9024630057900	
0.2283			5.800	66.00	28.00	9024630058000	
0.2323	A		5.900	66.00	28.00	9024630059000	
0.2339			5.940	66.00	28.00	9024630059400	
0.2343		15/64		5.950	66.00	28.00	9024630059500
0.2362			6.000	66.00	28.00	9024630060000	
0.2378	B		6.040	70.00	31.00	9024630060400	
0.2402			6.100	70.00	31.00	9024630061000	
0.2421	C		6.150	70.00	31.00	9024630061500	
0.2441			6.200	70.00	31.00	9024630062000	
0.2461	D		6.250	70.00	31.00	9024630062500	
0.2480			6.300	70.00	31.00	9024630063000	
0.2500	1/4	E	6.350	70.00	31.00	9024630063500	
0.2520				6.400	70.00	31.00	9024630064000
0.2559	F		6.500	70.00	31.00	9024630065000	
0.2571			6.530	70.00	31.00	9024630065300	
0.2598	G		6.600	70.00	31.00	9024630066000	
0.2610			6.630	70.00	31.00	9024630066300	
0.2638	17/64	H	6.700	70.00	31.00	9024630067000	
0.2657				6.750	74.00	34.00	9024630067500
0.2677				6.800	74.00	34.00	9024630068000
0.2717	J		6.900	74.00	34.00	9024630069000	
0.2756			7.000	74.00	34.00	9024630070000	
0.2768	K		7.030	74.00	34.00	9024630070300	
0.2795			7.100	74.00	34.00	9024630071000	
0.2811	9/32		7.140	74.00	34.00	9024630071400	
0.2835			7.200	74.00	34.00	9024630072000	
0.2874	L		7.300	74.00	34.00	9024630073000	
0.2902			7.370	74.00	34.00	9024630073700	
0.2913	19/64		7.400	74.00	34.00	9024630074000	
0.2953			7.500	74.00	34.00	9024630075000	
0.2969	N		7.540	79.00	37.00	9024630075400	
0.2992			7.600	79.00	37.00	9024630076000	
0.3020	O		7.670	79.00	37.00	9024630076700	
0.3031			7.700	79.00	37.00	9024630077000	
0.3071	21/64		7.800	79.00	37.00	9024630078000	
0.3110			7.900	79.00	37.00	9024630079000	
0.3126	Q		7.940	79.00	37.00	9024630079400	
0.3150			8.000	79.00	37.00	9024630080000	
0.3161	R		8.030	79.00	37.00	9024630080300	
0.3189			8.100	79.00	37.00	9024630081000	
0.3228	2		8.200	79.00	37.00	9024630082000	
0.3268			8.300	79.00	37.00	9024630083000	
0.3280	1		8.330	79.00	37.00	9024630083300	
0.3307			8.400	79.00	37.00	9024630084000	
0.3319	3/8		8.430	79.00	37.00	9024630084300	
0.3346			8.500	79.00	37.00	9024630085000	
0.3386	1/2		8.600	84.00	40.00	9024630086000	
0.3390			8.610	84.00	40.00	9024630086100	

Dec. inch	Diameter (d1)			I1 mm	I2 mm	EDP #
	Fract. inch	Wire / letter	mm			
0.3425	11/32		8.700	84.00	40.00	9024630087000
0.3437			8.730	84.00	40.00	9024630087300
0.3465	S		8.800	84.00	40.00	9024630088000
0.3480			8.840	84.00	40.00	9024630088400
0.3504	T		8.900	84.00	40.00	9024630089000
0.3543			9.000	84.00	40.00	9024630090000
0.3579	23/64		9.090	84.00	40.00	9024630090900
0.3583			9.100	84.00	40.00	9024630091000
0.3594	U		9.130	84.00	40.00	9024630091300
0.3622			9.200	84.00	40.00	9024630092000
0.3661	V		9.300	84.00	40.00	9024630093000
0.3677			9.340	84.00	40.00	9024630093400
0.3701	3/8		9.400	84.00	40.00	9024630094000
0.3740			9.500	84.00	40.00	9024630095000
0.3748	W		9.520	89.00	43.00	9024630095200
0.3772			9.580	89.00	43.00	9024630095800
0.3780	25/64		9.600	89.00	43.00	9024630096000
0.3819			9.700	89.00	43.00	9024630097000
0.3858	X		9.800	89.00	43.00	9024630098000
0.3898			9.900	89.00	43.00	9024630099000
0.3906	10/32		9.920	89.00	43.00	9024630099200
0.3937			10.000	89.00	43.00	9024630100000
0.3969	Y		10.080	89.00	43.00	9024630100800
0.4016			10.200	89.00	43.00	9024630102000
0.4039	13/32		10.260	89.00	43.00	9024630102600
0.4055			10.300	89.00	43.00	9024630103000
0.4063	Z		10.320	89.00	43.00	9024630103200
0.4130			10.490	89.00	43.00	9024630104900
0.4134	27/64		10.500	89.00	43.00	9024630105000
0.4220			10.720	95.00	47.00	9024630107200
0.4331	7/16		11.000	95.00	47.00	9024630110000
0.4374			11.110	95.00	47.00	9024630111100
0.4528	29/64		11.500	95.00	47.00	9024630115000
0.4531			11.510	95.00	47.00	9024630115100
0.4689	15/32		11.910	102.00	51.00	9024630119100
0.4724			12.000	102.00	51.00	9024630120000
0.4843	1/2		12.300	102.00	51.00	9024630123000
0.5000			12.700	102.00	51.00	9024630127000
0.5118	17/32		13.000	102.00	51.00	9024630130000
0.5311			13.490	107.00	54.00	9024630134900
0.5512	9/16		14.000	107.00	54.00	9024630140000
0.5626			14.290	111.00	56.00	9024630142900
0.5906	3/4		15.000	111.00	56.00	9024630150000
0.6299			16.000	115.00	58.00	9024630160000

Alternative Drill Series:

- #730 Carbide, GP, 3xD, 118 pt, Bright
- #5521 PM Cobalt, GT500, 3xD, 130 pt, TiN
- #515 PM Cobalt, GT500, 3xD, 130 pt, FIREX®
- #659 Cobalt, GV120, 3xD, 130 pt, TiN

*Items listed in red are non-stocked items, and may take 2 - 6 weeks to receive

5xD

Twist Drills



FIREX® Coated



External Coolant

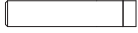

Straight Shank

Speeds & Feeds
Information pg 464

Series 2464

General Purpose

Carbide, general purpose (Type N), jobber length,
118° faceted point, standard straight shank, RH helix

Cut / Shank Dia. = h8 tolerance range

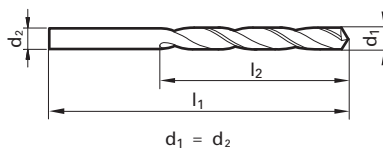

Application Materials:

- General Steels/Brass
- Universal Steels
- Cast Iron



Dec. inch	Diameter (d1)			l1 mm	l2 mm	EDP #
	Fract. inch	Wire / letter	mm			
0.0394			1.000	34.00	12.00	9024640010000
0.0402		60	1.020	34.00	12.00	9024640010200
0.0409		59	1.040	34.00	12.00	9024640010400
0.0421		58	1.070	36.00	14.00	9024640010700
0.0429		57	1.090	36.00	14.00	9024640010900
0.0433			1.100	36.00	14.00	9024640011000
0.0465		56	1.180	36.00	14.00	9024640011800
0.0469	3/64		1.190	36.00	14.00	9024640011900
0.0472			1.200	38.00	16.00	9024640012000
0.0512			1.300	38.00	16.00	9024640013000
0.0520		55	1.320	38.00	16.00	9024640013200
0.0551		54	1.400	40.00	18.00	9024640014000
0.0591			1.500	40.00	18.00	9024640015000
0.0594		53	1.510	43.00	20.00	9024640015100
0.0626	1/16		1.590	43.00	20.00	9024640015900
0.0630			1.600	43.00	20.00	9024640016000
0.0634		52	1.610	43.00	20.00	9024640016100
0.0669		51	1.700	43.00	20.00	9024640017000
0.0701		50	1.780	46.00	22.00	9024640017800
0.0709			1.800	46.00	22.00	9024640018000
0.0728		49	1.850	46.00	22.00	9024640018500
0.0748			1.900	46.00	22.00	9024640019000
0.0760		48	1.930	49.00	24.00	9024640019300
0.0780	5/64		1.980	49.00	24.00	9024640019800
0.0783		47	1.990	49.00	24.00	9024640019900
0.0787			2.000	49.00	24.00	9024640020000
0.0811		46	2.060	49.00	24.00	9024640020600
0.0819		45	2.080	49.00	24.00	9024640020800
0.0827			2.100	49.00	24.00	9024640021000
0.0858		44	2.180	53.00	27.00	9024640021800
0.0866			2.200	53.00	27.00	9024640022000
0.0890		43	2.260	53.00	27.00	9024640022600
0.0906			2.300	53.00	27.00	9024640023000
0.0933		42	2.370	57.00	30.00	9024640023700
0.0937	3/32		2.380	57.00	30.00	9024640023800
0.0945			2.400	57.00	30.00	9024640024000
0.0961		41	2.440	57.00	30.00	9024640024400
0.0980		40	2.490	57.00	30.00	9024640024900
0.0984			2.500	57.00	30.00	9024640025000
0.0996		39	2.530	57.00	30.00	9024640025300
0.1016		38	2.580	57.00	30.00	9024640025800
0.1024			2.600	57.00	30.00	9024640026000
0.1039		37	2.640	57.00	30.00	9024640026400
0.1063			2.700	61.00	33.00	9024640027000
0.1067		36	2.710	61.00	33.00	9024640027100
0.1094	7/64		2.780	61.00	33.00	9024640027800
0.1098		35	2.790	61.00	33.00	9024640027900
0.1102			2.800	61.00	33.00	9024640028000
0.1110		34	2.820	61.00	33.00	9024640028200
0.1130		33	2.870	61.00	33.00	9024640028700
0.1142			2.900	61.00	33.00	9024640029000
0.1161		32	2.950	61.00	33.00	9024640029500
0.1181			3.000	61.00	33.00	9024640030000
0.1201		31	3.050	65.00	36.00	9024640030500

Dec. inch	Diameter (d1)			l1 mm	l2 mm	EDP #
	Fract. inch	Wire / letter	mm			
0.1220			3.100	65.00	36.00	9024640031000
0.1248	1/8		3.170	65.00	36.00	9024640031700
0.1260			3.200	65.00	36.00	9024640032000
0.1283		30	3.260	65.00	36.00	9024640032600
0.1299			3.300	65.00	36.00	9024640033000
0.1339			3.400	70.00	39.00	9024640034000
0.1358		29	3.450	70.00	39.00	9024640034500
0.1378			3.500	70.00	39.00	9024640035000
0.1406	9/64	28	3.570	70.00	39.00	9024640035700
0.1417			3.600	70.00	39.00	9024640036000
0.1441		27	3.660	70.00	39.00	9024640036600
0.1457			3.700	70.00	39.00	9024640037000
0.1469		26	3.730	70.00	39.00	9024640037300
0.1496		25	3.800	75.00	43.00	9024640038000
0.1520		24	3.860	75.00	43.00	9024640038600
0.1535			3.900	75.00	43.00	9024640039000
0.1539		23	3.910	75.00	43.00	9024640039100
0.1563	5/32		3.970	75.00	43.00	9024640039700
0.1571		22	3.990	75.00	43.00	9024640039900
0.1575			4.000	75.00	43.00	9024640040000
0.1591		21	4.040	75.00	43.00	9024640040400
0.1610		20	4.090	75.00	43.00	9024640040900
0.1614			4.100	75.00	43.00	9024640041000
0.1654			4.200	75.00	43.00	9024640042000
0.1661		19	4.220	75.00	43.00	9024640042200
0.1693		18	4.300	80.00	47.00	9024640043000
0.1720	11/64		4.370	80.00	47.00	9024640043700
0.1728		17	4.390	80.00	47.00	9024640043900
0.1732			4.400	80.00	47.00	9024640044000
0.1772		16	4.500	80.00	47.00	9024640045000
0.1799		15	4.570	80.00	47.00	9024640045700
0.1811			4.600	80.00	47.00	9024640046000
0.1819		14	4.620	80.00	47.00	9024640046200
0.1850		13	4.700	80.00	47.00	9024640047000
0.1874	3/16		4.760	86.00	52.00	9024640047600
0.1890		12	4.800	86.00	52.00	9024640048000
0.1909		11	4.850	86.00	52.00	9024640048500
0.1929			4.900	86.00	52.00	9024640049000
0.1937		10	4.920	86.00	52.00	9024640049200
0.1961		9	4.980	86.00	52.00	9024640049800
0.1969			5.000	86.00	52.00	9024640050000
0.1992		8	5.060	86.00	52.00	9024640050600
0.2008			5.100	86.00	52.00	9024640051000
0.2012		7	5.110	86.00	52.00	9024640051100
0.2031	13/64		5.160	86.00	52.00	9024640051600
0.2039		6	5.180	86.00	52.00	9024640051800
0.2047			5.200	86.00	52.00	9024640052000
0.2055		5	5.220	86.00	52.00	9024640052200
0.2087			5.300	86.00	52.00	9024640053000
0.2091		4	5.310	93.00	57.00	9024640053100
0.2126			5.400	93.00	57.00	9024640054000
0.2130		3	5.410	93.00	57.00	9024640054100
0.2165			5.500	93.00	57.00	9024640055000
0.2189	7/32		5.560	93.00	57.00	9024640055600

Series 2464

Speeds & Feeds information pg 464

Twist Drills

Dec. inch	Diameter (d1)		l1 mm	l2 mm	EDP #	
	Fract. inch	Wire / letter				
0.2205			5.600	93.00	57.00	9024640056000
0.2209		2	5.610	93.00	57.00	9024640056100
0.2244			5.700	93.00	57.00	9024640057000
0.2280		1	5.790	93.00	57.00	9024640057900
0.2283			5.800	93.00	57.00	9024640058000
0.2323			5.900	93.00	57.00	9024640059000
0.2339		A	5.940	93.00	57.00	9024640059400
0.2343	15/64		5.950	93.00	57.00	9024640059500
0.2362			6.000	93.00	57.00	9024640060000
0.2378		B	6.040	101.00	63.00	9024640060400
0.2402			6.100	101.00	63.00	9024640061000
0.2421		C	6.150	101.00	63.00	9024640061500
0.2441			6.200	101.00	63.00	9024640062000
0.2461		D	6.250	101.00	63.00	9024640062500
0.2480			6.300	101.00	63.00	9024640063000
0.2500	1/4	E	6.350	101.00	63.00	9024640063500
0.2520			6.400	101.00	63.00	9024640064000
0.2559			6.500	101.00	63.00	9024640065000
0.2571		F	6.530	101.00	63.00	9024640065300
0.2598			6.600	101.00	63.00	9024640066000
0.2610		G	6.630	101.00	63.00	9024640066300
0.2638			6.700	101.00	63.00	9024640067000
0.2657	17/64	H	6.750	109.00	69.00	9024640067500
0.2677			6.800	109.00	69.00	9024640068000
0.2717		I	6.900	109.00	69.00	9024640069000
0.2756			7.000	109.00	69.00	9024640070000
0.2768		J	7.030	109.00	69.00	9024640070300
0.2795			7.100	109.00	69.00	9024640071000
0.2811	9/32	K	7.140	109.00	69.00	9024640071400
0.2835			7.200	109.00	69.00	9024640072000
0.2874			7.300	109.00	69.00	9024640073000
0.2902		L	7.370	109.00	69.00	9024640073700
0.2913			7.400	109.00	69.00	9024640074000
0.2949		M	7.490	109.00	69.00	9024640074900
0.2953			7.500	109.00	69.00	9024640075000
0.2969	19/64		7.540	117.00	75.00	9024640075400
0.2992			7.600	117.00	75.00	9024640076000
0.3020		N	7.670	117.00	75.00	9024640076700
0.3031			7.700	117.00	75.00	9024640077000
0.3071			7.800	117.00	75.00	9024640078000
0.3110			7.900	117.00	75.00	9024640079000
0.3126	5/16		7.940	117.00	75.00	9024640079400
0.3150			8.000	117.00	75.00	9024640080000
0.3161		O	8.030	117.00	75.00	9024640080300
0.3189			8.100	117.00	75.00	9024640081000
0.3228		P	8.200	117.00	75.00	9024640082000
0.3268			8.300	117.00	75.00	9024640083000
0.3280	21/64		8.330	117.00	75.00	9024640083300
0.3307			8.400	117.00	75.00	9024640084000
0.3319		Q	8.430	117.00	75.00	9024640084300

Dec. inch	Diameter (d1)		l1 mm	l2 mm	EDP #	
	Fract. inch	Wire / letter				
0.3346			8.500	117.00	75.00	9024640085000
0.3386			8.600	125.00	81.00	9024640086000
0.3390		R	8.610	125.00	81.00	9024640086100
0.3425			8.700	125.00	81.00	9024640087000
0.3437	11/32		8.730	125.00	81.00	9024640087300
0.3465			8.800	125.00	81.00	9024640088000
0.3480		S	8.840	125.00	81.00	9024640088400
0.3504			8.900	125.00	81.00	9024640089000
0.3543			9.000	125.00	81.00	9024640090000
0.3579		T	9.090	125.00	81.00	9024640090900
0.3583			9.100	125.00	81.00	9024640091000
0.3594	23/64		9.130	125.00	81.00	9024640091300
0.3622			9.200	125.00	81.00	9024640092000
0.3661			9.300	125.00	81.00	9024640093000
0.3677		U	9.340	125.00	81.00	9024640093400
0.3701			9.400	125.00	81.00	9024640094000
0.3740			9.500	125.00	81.00	9024640095000
0.3748	3/8		9.520	133.00	87.00	9024640095200
0.3772		V	9.580	133.00	87.00	9024640095800
0.3780			9.600	133.00	87.00	9024640096000
0.3819			9.700	133.00	87.00	9024640097000
0.3858		W	9.800	133.00	87.00	9024640098000
0.3898			9.900	133.00	87.00	9024640099000
0.3906	25/64		9.920	133.00	87.00	9024640099200
0.3937			10.000	133.00	87.00	9024640100000
0.3969		X	10.080	133.00	87.00	9024640100800
0.4016			10.200	133.00	87.00	9024640102000
0.4039		Y	10.260	133.00	87.00	9024640102600
0.4055			10.300	133.00	87.00	9024640103000
0.4063	13/32		10.320	133.00	87.00	9024640103200
0.4130		Z	10.490	133.00	87.00	9024640104900
0.4134			10.500	133.00	87.00	9024640105000
0.4220	27/64		10.720	142.00	94.00	9024640107200
0.4331			11.000	142.00	94.00	9024640110000
0.4374	7/16		11.110	142.00	94.00	9024640111100
0.4528			11.500	142.00	94.00	9024640115000
0.4531	29/64		11.510	142.00	94.00	9024640115100
0.4689	15/32		11.910	151.00	101.00	9024640119100
0.4724			12.000	151.00	101.00	9024640120000
0.4843	31/64		12.300	151.00	101.00	9024640123000
0.5000	1/2		12.700	151.00	101.00	9024640127000

Alternative Drill Series:

#732 Carbide, GP, 5xD, 118 pt, Bright
 #2602 Carbide, GT100, 5xD, 130 pt, TiN
 #5522 PM Cobalt, GT500, 5xD, 130 pt, TiN

*Items listed in red are non-stocked items, and may take 2 - 6 weeks to receive

3xD

N
nano-FIREX®
coated



Coolant Through



Reinforced Straight Shank

Speeds & Feeds
information pg 465

Series 2477

RT 100 X High Penetration

Carbide, RT 100 X high penetration, 3xD, self-centering
140° SU point, reinforced straight shank, RH helix

Cut Dia. = m7 tolerance range, Shank Dia. = h6

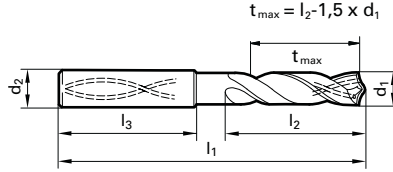

Application Materials:

- General Steels/Brass
- Universal Steels
- Stainless Steels
- Cast Iron

Diameter (d1)		d2	l1	l2	EDP #
Dec. inch	Fract. inch	mm	mm	mm	
0.1181		3.000	62.00	20.00	9024770030000
0.1220		3.100	62.00	20.00	9024770031000
0.1248	1/8	3.170	62.00	20.00	9024770031700
0.1260		3.200	62.00	20.00	9024770032000
0.1280		3.250	62.00	20.00	9024770032500
0.1299		3.300	62.00	20.00	9024770033000
0.1339		3.400	62.00	20.00	9024770034000
0.1378		3.500	62.00	20.00	9024770035000
0.1406	9/64	3.570	62.00	20.00	9024770035700
0.1417		3.600	62.00	20.00	9024770036000
0.1457		3.700	62.00	20.00	9024770037000
0.1496		3.800	66.00	24.00	9024770038000
0.1535		3.900	66.00	24.00	9024770039000
0.1563	5/32	3.970	66.00	24.00	9024770039700
0.1575		4.000	66.00	24.00	9024770040000
0.1591		4.040	66.00	24.00	9024770040400
0.1614		4.100	66.00	24.00	9024770041000
0.1654		4.200	66.00	24.00	9024770042000
0.1693		4.300	66.00	24.00	9024770043000
0.1720	11/64	4.370	66.00	24.00	9024770043700
0.1732		4.400	66.00	24.00	9024770044000
0.1772		4.500	66.00	24.00	9024770045000
0.1811		4.600	66.00	24.00	9024770046000
0.1831		4.650	66.00	24.00	9024770046500
0.1850		4.700	66.00	24.00	9024770047000
0.1874	3/16	4.760	66.00	28.00	9024770047600
0.1890		4.800	66.00	28.00	9024770048000
0.1929		4.900	66.00	28.00	9024770049000
0.1969		5.000	66.00	28.00	9024770050000
0.2008		5.100	66.00	28.00	9024770051000
0.2012		5.110	66.00	28.00	9024770051100
0.2031	13/64	5.160	66.00	28.00	9024770051600
0.2047		5.200	66.00	28.00	9024770052000
0.2087		5.300	66.00	28.00	9024770053000
0.2126		5.400	66.00	28.00	9024770054000
0.2130		5.410	66.00	28.00	9024770054100
0.2165		5.500	66.00	28.00	9024770055000
0.2185		5.550	66.00	28.00	9024770055500
0.2189	7/32	5.560	66.00	28.00	9024770055600
0.2205		5.600	66.00	28.00	9024770056000
0.2224		5.650	66.00	28.00	9024770056500
0.2244		5.700	66.00	28.00	9024770057000
0.2283		5.800	66.00	28.00	9024770058000
0.2323		5.900	66.00	28.00	9024770059000
0.2343	15/64	5.950	66.00	28.00	9024770059500
0.2362		6.000	66.00	28.00	9024770060000
0.2402		6.100	79.00	34.00	9024770061000
0.2441		6.200	79.00	34.00	9024770062000
0.2480		6.300	79.00	34.00	9024770063000
0.2500	1/4	6.350	79.00	34.00	9024770063500
0.2520		6.400	79.00	34.00	9024770064000
0.2559		6.500	79.00	34.00	9024770065000
0.2571		6.530	79.00	34.00	9024770065300
0.2598		6.600	79.00	34.00	9024770066000

Diameter (d1)		d2	l1	l2	EDP #
Dec. inch	Fract. inch	mm	mm	mm	
0.2638		6.700	79.00	34.00	9024770067000
0.2657	17/64	6.750	8.000	79.00	9024770067500
0.2677		6.800	8.000	79.00	9024770068000
0.2717		6.900	8.000	79.00	9024770069000
0.2756		7.000	8.000	79.00	9024770070000
0.2795		7.100	8.000	79.00	9024770071000
0.2811	9/32	7.140	8.000	79.00	9024770071400
0.2835		7.200	8.000	79.00	9024770072000
0.2874		7.300	8.000	79.00	9024770073000
0.2913		7.400	8.000	79.00	9024770074000
0.2953		7.500	8.000	79.00	9024770075000
0.2969	19/64	7.540	8.000	79.00	9024770075400
0.2972		7.550	8.000	79.00	9024770075500
0.2992		7.600	8.000	79.00	9024770076000
0.3031		7.700	8.000	79.00	9024770077000
0.3071		7.800	8.000	79.00	9024770078000
0.3110		7.900	8.000	79.00	9024770079000
0.3126	5/16	7.940	8.000	79.00	9024770079400
0.3150		8.000	8.000	79.00	9024770080000
0.3189		8.100	10.000	89.00	9024770081000
0.3228		8.200	10.000	89.00	9024770082000
0.3268		8.300	10.000	89.00	9024770083000
0.3280	21/64	8.330	10.000	89.00	9024770083300
0.3307		8.400	10.000	89.00	9024770084000
0.3346		8.500	10.000	89.00	9024770085000
0.3386		8.600	10.000	89.00	9024770086000
0.3425		8.700	10.000	89.00	9024770087000
0.3437	11/32	8.730	10.000	89.00	9024770087300
0.3465		8.800	10.000	89.00	9024770088000
0.3504		8.900	10.000	89.00	9024770089000
0.3543		9.000	10.000	89.00	9024770090000
0.3583		9.100	10.000	89.00	9024770091000
0.3594	23/64	9.130	10.000	89.00	9024770091300
0.3622		9.200	10.000	89.00	9024770092000
0.3642		9.250	10.000	89.00	9024770092500
0.3661		9.300	10.000	89.00	9024770093000
0.3677		9.340	10.000	89.00	9024770093400
0.3701		9.400	10.000	89.00	9024770094000
0.3740		9.500	10.000	89.00	9024770095000
0.3748	3/8	9.520	10.000	89.00	9024770095200
0.3759		9.550	10.000	89.00	9024770095500
0.3780		9.600	10.000	89.00	9024770096000
0.3819		9.700	10.000	89.00	9024770097000
0.3858		9.800	10.000	89.00	9024770098000
0.3898		9.900	10.000	89.00	9024770099000
0.3906	25/64	9.920	10.000	89.00	9024770099200
0.3937		10.000	10.000	89.00	9024770100000
0.3976		10.100	12.000	102.00	9024770101000
0.4016		10.200	12.000	102.00	9024770102000
0.4055		10.300	12.000	102.00	9024770103000
0.4063	13/32	10.320	12.000	102.00	9024770103200
0.4094		10.400	12.000	102.00	9024770104000
0.4134		10.500	12.000	102.00	9024770105000
0.4173		10.600	12.000	102.00	9024770106000

Series 2477

Speeds & Feeds information pg 465

Twist Drills

Diameter (d1)		Wire / letter	d2 mm	l1 mm	l2 mm	EDP #	
Dec. inch	Fract. inch						
0.4213			10.700	12.000	102.00	55.00	9024770107000
0.4220	27/64		10.720	12.000	102.00	55.00	9024770107200
0.4252			10.800	12.000	102.00	55.00	9024770108000
0.4291			10.900	12.000	102.00	55.00	9024770109000
0.4331			11.000	12.000	102.00	55.00	9024770110000
0.4370			11.100	12.000	102.00	55.00	9024770111000
0.4374	7/16		11.110	12.000	102.00	55.00	9024770111100
0.4409			11.200	12.000	102.00	55.00	9024770112000
0.4449			11.300	12.000	102.00	55.00	9024770113000
0.4488			11.400	12.000	102.00	55.00	9024770114000
0.4528			11.500	12.000	102.00	55.00	9024770115000
0.4531	29/64		11.510	12.000	102.00	55.00	9024770115100
0.4567			11.600	12.000	102.00	55.00	9024770116000
0.4606			11.700	12.000	102.00	55.00	9024770117000
0.4646			11.800	12.000	102.00	55.00	9024770118000
0.4685			11.900	12.000	102.00	55.00	9024770119000
0.4689	15/32		11.910	12.000	102.00	55.00	9024770119100
0.4724			12.000	12.000	102.00	55.00	9024770120000
0.4764			12.100	14.000	107.00	60.00	9024770121000
0.4803			12.200	14.000	107.00	60.00	9024770122000
0.4843	31/64		12.300	14.000	107.00	60.00	9024770123000
0.4882			12.400	14.000	107.00	60.00	9024770124000
0.4921			12.500	14.000	107.00	60.00	9024770125000
0.4961			12.600	14.000	107.00	60.00	9024770126000
0.5000	1/2		12.700	14.000	107.00	60.00	9024770127000
0.5039			12.800	14.000	107.00	60.00	9024770128000
0.5079			12.900	14.000	107.00	60.00	9024770129000
0.5118			13.000	14.000	107.00	60.00	9024770130000
0.5157			13.100	14.000	107.00	60.00	9024770131000
0.5197			13.200	14.000	107.00	60.00	9024770132000
0.5236			13.300	14.000	107.00	60.00	9024770133000
0.5276			13.400	14.000	107.00	60.00	9024770134000
0.5311	17/32		13.490	14.000	107.00	60.00	9024770134900
0.5315			13.500	14.000	107.00	60.00	9024770135000
0.5354			13.600	14.000	107.00	60.00	9024770136000
0.5394			13.700	14.000	107.00	60.00	9024770137000
0.5433			13.800	14.000	107.00	60.00	9024770138000
0.5469	35/64		13.890	14.000	107.00	60.00	9024770138900
0.5472			13.900	14.000	107.00	60.00	9024770139000
0.5512			14.000	14.000	107.00	60.00	9024770140000
0.5551			14.100	16.000	115.00	65.00	9024770141000
0.5591			14.200	16.000	115.00	65.00	9024770142000
0.5626	9/16		14.290	16.000	115.00	65.00	9024770142900
0.5630			14.300	16.000	115.00	65.00	9024770143000
0.5669			14.400	16.000	115.00	65.00	9024770144000

Diameter (d1)		Wire / letter	d2 mm	l1 mm	l2 mm	EDP #	
Dec. inch	Fract. inch						
0.5709			14.500	16.000	115.00	65.00	9024770145000
0.5748			14.600	16.000	115.00	65.00	9024770146000
0.5780	37/64		14.680	16.000	115.00	65.00	9024770146800
0.5787			14.700	16.000	115.00	65.00	9024770147000
0.5827			14.800	16.000	115.00	65.00	9024770148000
0.5866			14.900	16.000	115.00	65.00	9024770149000
0.5906			15.000	16.000	115.00	65.00	9024770150000
0.5937	19/32		15.080	16.000	115.00	65.00	9024770150800
0.5945			15.100	16.000	115.00	65.00	9024770151000
0.5984			15.200	16.000	115.00	65.00	9024770152000
0.6024			15.300	16.000	115.00	65.00	9024770153000
0.6094	39/64		15.480	16.000	115.00	65.00	9024770154800
0.6102			15.500	16.000	115.00	65.00	9024770155000
0.6142			15.600	16.000	115.00	65.00	9024770156000
0.6181			15.700	16.000	115.00	65.00	9024770157000
0.6220			15.800	16.000	115.00	65.00	9024770158000
0.6248			15.870	16.000	115.00	65.00	9024770158700
0.6260			15.900	16.000	115.00	65.00	9024770159000
0.6299			16.000	16.000	115.00	65.00	9024770160000
0.6378			16.200	18.000	123.00	73.00	9024770162000
0.6406	41/64		16.270	18.000	123.00	73.00	9024770162700
0.6496			16.500	18.000	123.00	73.00	9024770165000
0.6563	21/32		16.670	18.000	123.00	73.00	9024770166700
0.6654			16.900	18.000	123.00	73.00	9024770169000
0.6693			17.000	18.000	123.00	73.00	9024770170000
0.6720	43/64		17.070	18.000	123.00	73.00	9024770170700
0.6874	11/16		17.460	18.000	123.00	73.00	9024770174600
0.6890			17.500	18.000	131.00	79.00	9024770175000
0.7031	45/64		17.860	18.000	131.00	79.00	9024770178600
0.7087			18.000	18.000	131.00	79.00	9024770180000
0.7189	23/32		18.260	20.000	131.00	79.00	9024770182600
0.7283			18.500	20.000	131.00	79.00	9024770185000
0.7441			18.900	20.000	131.00	79.00	9024770189000
0.7480			19.000	20.000	131.00	79.00	9024770190000
0.7500	3/4		19.050	20.000	131.00	79.00	9024770190500
0.7579			19.250	20.000	131.00	79.00	9024770192500
0.7598			19.300	20.000	131.00	79.00	9024770193000
0.7656	49/64		19.446	20.000	131.00	79.00	9024770194460
0.7811	25/32		19.840	20.000	131.00	79.00	9024770198400
0.7874			20.000	20.000	131.00	79.00	9024770200000

Alternative Drill Series:

#5510 Carbide, RT100, 3xD, 140 U pt, FIREX®
#8510 Carbide, RT100VA, 3xD, 140 U pt, nano-TiAlN

*Items listed in red are non-stocked items, and may take 2 - 6 weeks to receive

Series 2479

Speeds & Feeds information pg 465

Twist Drills

Diameter (d1)			d2	l1	l2	EDP #	
Dec. Inch	Fract. Inch	Wire / letter	mm	mm	mm		
0.4220	27/64		10.720	12.000	118.00	71.00	9024790107200
0.4252			10.800	12.000	118.00	71.00	9024790108000
0.4291			10.900	12.000	118.00	71.00	9024790109000
0.4331			11.000	12.000	118.00	71.00	9024790110000
0.4370			11.100	12.000	118.00	71.00	9024790111000
0.4374	7/16		11.110	12.000	118.00	71.00	9024790111100
0.4409			11.200	12.000	118.00	71.00	9024790112000
0.4449			11.300	12.000	118.00	71.00	9024790113000
0.4488			11.400	12.000	118.00	71.00	9024790114000
0.4528			11.500	12.000	118.00	71.00	9024790115000
0.4531			11.510	12.000	118.00	71.00	9024790115100
0.4567			11.600	12.000	118.00	71.00	9024790116000
0.4606			11.700	12.000	118.00	71.00	9024790117000
0.4646			11.800	12.000	118.00	71.00	9024790118000
0.4685			11.900	12.000	118.00	71.00	9024790119000
0.4689	15/32		11.910	12.000	118.00	71.00	9024790119100
0.4724			12.000	12.000	118.00	71.00	9024790120000
0.4764			12.100	14.000	124.00	77.00	9024790121000
0.4803			12.200	14.000	124.00	77.00	9024790122000
0.4843	31/64		12.300	14.000	124.00	77.00	9024790123000
0.4882			12.400	14.000	124.00	77.00	9024790124000
0.4921			12.500	14.000	124.00	77.00	9024790125000
0.4961			12.600	14.000	124.00	77.00	9024790126000
0.5000	1/2		12.700	14.000	124.00	77.00	9024790127000
0.5039			12.800	14.000	124.00	77.00	9024790128000
0.5079			12.900	14.000	124.00	77.00	9024790129000
0.5118			13.000	14.000	124.00	77.00	9024790130000
0.5157			13.100	14.000	124.00	77.00	9024790131000
0.5197			13.200	14.000	124.00	77.00	9024790132000
0.5236			13.300	14.000	124.00	77.00	9024790133000
0.5276			13.400	14.000	124.00	77.00	9024790134000
0.5311	17/32		13.490	14.000	124.00	77.00	9024790134900
0.5315			13.500	14.000	124.00	77.00	9024790135000
0.5354			13.600	14.000	124.00	77.00	9024790136000
0.5394			13.700	14.000	124.00	77.00	9024790137000
0.5433			13.800	14.000	124.00	77.00	9024790138000
0.5469	35/64		13.890	14.000	124.00	77.00	9024790138900
0.5472			13.900	14.000	124.00	77.00	9024790139000
0.5512			14.000	14.000	124.00	77.00	9024790140000
0.5551			14.100	16.000	133.00	83.00	9024790141000
0.5591			14.200	16.000	133.00	83.00	9024790142000
0.5626	9/16		14.290	16.000	133.00	83.00	9024790142900
0.5669			14.400	16.000	133.00	83.00	9024790144000
0.5709			14.500	16.000	133.00	83.00	9024790145000
0.5748			14.600	16.000	133.00	83.00	9024790146000
0.5780	37/64		14.680	16.000	133.00	83.00	9024790146800

Diameter (d1)			d2	l1	l2	EDP #	
Dec. Inch	Fract. Inch	Wire / letter	mm	mm	mm		
0.5787			14.700	16.000	133.00	83.00	9024790147000
0.5827			14.800	16.000	133.00	83.00	9024790148000
0.5866			14.900	16.000	133.00	83.00	9024790149000
0.5906			15.000	16.000	133.00	83.00	9024790150000
0.5937	19/32		15.080	16.000	133.00	83.00	9024790150800
0.5945			15.100	16.000	133.00	83.00	9024790151000
0.5984			15.200	16.000	133.00	83.00	9024790152000
0.6024			15.300	16.000	133.00	83.00	9024790153000
0.6063			15.400	16.000	133.00	83.00	9024790154000
0.6094	39/64		15.480	16.000	133.00	83.00	9024790154800
0.6102			15.500	16.000	133.00	83.00	9024790155000
0.6142			15.600	16.000	133.00	83.00	9024790156000
0.6181			15.700	16.000	133.00	83.00	9024790157000
0.6220			15.800	16.000	133.00	83.00	9024790158000
0.6248	5/8		15.870	16.000	133.00	83.00	9024790158700
0.6260			15.900	16.000	133.00	83.00	9024790159000
0.6299			16.000	16.000	133.00	83.00	9024790160000
0.6406	41/64		16.270	18.000	143.00	93.00	9024790162700
0.6496			16.500	18.000	143.00	93.00	9024790165000
0.6563	21/32		16.670	18.000	143.00	93.00	9024790166700
0.6693			17.000	18.000	143.00	93.00	9024790170000
0.6720	43/64		17.070	18.000	143.00	93.00	9024790170700
0.6874	11/16		17.460	18.000	143.00	93.00	9024790174600
0.6890			17.500	18.000	143.00	93.00	9024790175000
0.7031	45/64		17.860	18.000	143.00	93.00	9024790178600
0.7087			18.000	18.000	143.00	93.00	9024790180000
0.7189	23/32		18.260	20.000	153.00	101.00	9024790182600
0.7283			18.500	20.000	153.00	101.00	9024790185000
0.7441			18.900	20.000	153.00	101.00	9024790189000
0.7480			19.000	20.000	153.00	101.00	9024790190000
0.7500	3/4		19.050	20.000	153.00	101.00	9024790190500
0.7579			19.250	20.000	153.00	101.00	9024790192500
0.7598			19.300	20.000	153.00	101.00	9024790193000
0.7656	49/64		19.446	20.000	153.00	101.00	9024790194460
0.7677			19.500	20.000	153.00	101.00	9024790195000
0.7811	25/32		19.840	20.000	153.00	101.00	9024790198400
0.7874			20.000	20.000	153.00	101.00	9024790200000

Alternative Drill Series:

- #5511 Carbide, RT100, 5xD, 140 U pt, FIREX®
- #8511 Carbide, RT100VA, 5xD, 140 U pt, nano-TiAlN
- #1662 Carbide, RT100, 5xD, 140 F pt, TiN

*Items listed in red are non-stocked items, and may take 2 - 6 weeks to receive

8xD



Bright Finish



External Coolant



Straight Shank

Speeds & Feeds
information pg 467

Series 2601

GT 100 Parabolic

Carbide, GT 100, jobber length, 130° point, Form A
web thinned all dia., standard straight shank, RH helix

Cut / Shank Dia. = h8 tolerance range

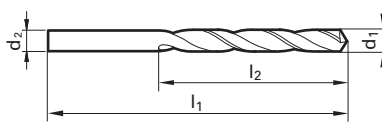

$$d_1 = d_2$$

Application Materials:



Aluminum & Alloys



Cast Iron

Diameter (d1)		Wire / letter	l1 mm	l2 mm	EDP #
Dec. inch	Fract. inch				
0.1248	1/8		69.85	41.28	9026010031700
0.1260			69.85	41.28	9026010032000
0.1283		30	69.85	41.28	9026010032600
0.1299			73.03	44.45	9026010033000
0.1339			73.03	44.45	9026010034000
0.1358		29	73.03	44.45	9026010034500
0.1378			73.03	44.45	9026010035000
0.1406	9/64	28	73.03	44.45	9026010035700
0.1441		27	76.20	47.63	9026010036600
0.1469		26	76.20	47.63	9026010037300
0.1496		25	76.20	47.63	9026010038000
0.1520		24	79.38	50.80	9026010038600
0.1539		23	79.38	50.80	9026010039100
0.1563	5/32		79.38	50.80	9026010039700
0.1571		22	79.38	50.80	9026010039900
0.1575			82.55	53.98	9026010040000
0.1591		21	82.55	53.98	9026010040400
0.1610		20	82.55	53.98	9026010040900
0.1661		19	82.55	53.98	9026010042200
0.1693		18	82.55	53.98	9026010043000
0.1720	11/64		82.55	53.98	9026010043700
0.1728		17	85.73	55.56	9026010043900
0.1772		16	85.73	55.56	9026010045000
0.1799		15	85.73	55.56	9026010045700
0.1819		14	85.73	55.56	9026010046200
0.1850		13	88.90	58.72	9026010047000
0.1874	3/16		88.90	58.72	9026010047600
0.1890		12	88.90	58.72	9026010048000
0.1909		11	88.90	58.72	9026010048500
0.1937		10	92.08	61.93	9026010049200
0.1961		9	92.08	61.93	9026010049800
0.1969			92.08	61.93	9026010050000
0.1992		8	92.08	61.93	9026010050600
0.2012		7	92.08	61.93	9026010051100
0.2031	13/64		92.08	61.93	9026010051600
0.2039		6	95.25	63.50	9026010051800
0.2055		5	95.25	63.50	9026010052200
0.2091		4	95.25	63.50	9026010053100
0.2130		3	95.25	63.50	9026010054100
0.2165			95.25	63.50	9026010055000
0.2189	7/32		95.25	63.50	9026010055600
0.2209		2	98.43	66.68	9026010056100
0.2280		1	98.43	66.68	9026010057900
0.2339		A	98.43	66.68	9026010059400
0.2343	15/64		98.43	66.68	9026010059500
0.2362			101.60	69.85	9026010060000
0.2378		B	101.60	69.85	9026010060400
0.2421		C	101.60	69.85	9026010061500
0.2461		D	101.60	69.85	9026010062500
0.2500	1/4	E	101.60	69.85	9026010063500
0.2559			104.78	73.03	9026010065000
0.2571		F	104.78	73.03	9026010065300
0.2610		G	104.78	73.03	9026010066300

Diameter (d1)		Wire / letter	l1 mm	l2 mm	EDP #
Dec. inch	Fract. inch				
0.2657	17/64	H	104.78	73.03	9026010067500
0.2717		I	104.78	73.03	9026010069000
0.2756			104.78	73.03	9026010070000
0.2768		J	104.78	73.03	9026010070300
0.2811	9/32	K	107.95	74.63	9026010071400
0.2902		L	107.95	74.63	9026010073700
0.2949		M	111.13	77.80	9026010074900
0.2953			111.13	77.80	9026010075000
0.2969	19/64		111.13	77.80	9026010075400
0.3020		N	111.13	77.80	9026010076700
0.3126	5/16		114.30	80.98	9026010079400
0.3150			114.30	80.98	9026010080000
0.3161		O	114.30	80.98	9026010080300
0.3228		P	117.48	84.15	9026010082000
0.3280	21/64		117.48	84.15	9026010083300
0.3319		Q	120.65	87.33	9026010084300
0.3346			120.65	87.33	9026010085000
0.3390		R	120.65	87.33	9026010086100
0.3437	11/32		120.65	87.33	9026010087300
0.3480		S	123.83	88.90	9026010088400
0.3543			123.83	88.90	9026010090000
0.3579		T	123.83	88.90	9026010090900
0.3594	23/64		123.83	88.90	9026010091300
0.3677		U	127.00	92.08	9026010093400
0.3740			127.00	92.08	9026010095000
0.3748	3/8		127.00	92.08	9026010095200
0.3772		V	127.00	92.08	9026010095800
0.3858		W	130.18	95.25	9026010098000
0.3906	25/64		130.18	95.25	9026010099200
0.3937			130.18	95.25	9026010100000
0.3969		X	130.18	95.25	9026010100800
0.4039		Y	133.35	98.43	9026010102600
0.4063	13/32		133.35	98.43	9026010103200
0.4130		Z	133.35	98.43	9026010104900
0.4134			133.35	98.43	9026010105000
0.4220	27/64		136.53	100.03	9026010107200
0.4331			139.70	103.20	9026010110000
0.4374	7/16		139.70	103.20	9026010111100
0.4528			142.88	106.36	9026010115000
0.4531	29/64		142.88	106.36	9026010115100
0.4689	15/32		146.05	109.55	9026010119100
0.4724			149.23	111.13	9026010120000
0.4843	31/64		149.23	111.13	9026010123000
0.4921			152.40	114.30	9026010125000
0.5000	1/2		152.40	114.30	9026010127000

Alternative Drill Series:

- #2464 Carbide, GP, 5xD, 118 pt, FIREX®
- #2602 Carbide, GT100, 5xD, 130 pt, TiN
- #732 Carbide, GP, 5xD, 118 pt, Bright
- #5522 PM Cobalt, GT500, 5xD, 130 pt, TiN

8xD



TiN coated



External Coolant



Straight Shank

Speeds & Feeds
information pg 468

Series 2602

GT 100 Parabolic

Carbide, GT 100, jobber length, 130° point, Form A
web thinned all dia., standard straight shank, RH helix

Cut / Shank Dia. = h8 tolerance range

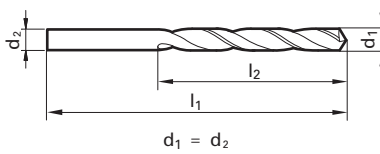

Application Materials:

- General Steels/Brass
- Aluminum & Alloys
- Cast Iron

Twist Drills

Dec. inch	Diameter (d1)		l1 mm	l2 mm	EDP #	
	Fract. inch	Wire / letter				
0.1248	1/8		3.170	69.85	41.28	9026020031700
0.1260			3.200	69.85	41.28	9026020032000
0.1283		30	3.260	69.85	41.28	9026020032600
0.1299			3.300	73.03	44.45	9026020033000
0.1339			3.400	73.03	44.45	9026020034000
0.1358		29	3.450	73.03	44.45	9026020034500
0.1378			3.500	73.03	44.45	9026020035000
0.1406	9/64	28	3.570	73.03	44.45	9026020035700
0.1441		27	3.660	76.20	47.63	9026020036600
0.1469		26	3.730	76.20	47.63	9026020037300
0.1496		25	3.800	76.20	47.63	9026020038000
0.1520		24	3.860	79.38	50.80	9026020038600
0.1539		23	3.910	79.38	50.80	9026020039100
0.1563	5/32		3.970	79.38	50.80	9026020039700
0.1571		22	3.990	79.38	50.80	9026020039900
0.1575			4.000	82.55	53.98	9026020040000
0.1591		21	4.040	82.55	53.98	9026020040400
0.1610		20	4.090	82.55	53.98	9026020040900
0.1661		19	4.220	82.55	53.98	9026020042200
0.1693		18	4.300	82.55	53.98	9026020043000
0.1720	11/64		4.370	82.55	53.98	9026020043700
0.1728		17	4.390	85.73	55.56	9026020043900
0.1772		16	4.500	85.73	55.56	9026020045000
0.1799		15	4.570	85.73	55.56	9026020045700
0.1819		14	4.620	85.73	55.56	9026020046200
0.1850		13	4.700	88.90	58.72	9026020047000
0.1874	3/16		4.760	88.90	58.72	9026020047600
0.1890		12	4.800	88.90	58.72	9026020048000
0.1909		11	4.850	88.90	58.72	9026020048500
0.1937		10	4.920	92.08	61.93	9026020049200
0.1961		9	4.980	92.08	61.93	9026020049800
0.1969			5.000	92.08	61.93	9026020050000
0.1992		8	5.060	92.08	61.93	9026020050600
0.2012		7	5.110	92.08	61.93	9026020051100
0.2031	13/64		5.160	92.08	61.93	9026020051600
0.2039		6	5.180	95.25	63.50	9026020051800
0.2055		5	5.220	95.25	63.50	9026020052200
0.2091		4	5.310	95.25	63.50	9026020053100
0.2130		3	5.410	95.25	63.50	9026020054100
0.2165			5.500	95.25	63.50	9026020055000
0.2189	7/32		5.560	95.25	63.50	9026020055600
0.2209		2	5.610	98.43	66.68	9026020056100
0.2280		1	5.790	98.43	66.68	9026020057900
0.2339		A	5.940	98.43	66.68	9026020059400
0.2343	15/64		5.950	98.43	66.68	9026020059500
0.2362			6.000	101.60	69.85	9026020060000
0.2378		B	6.040	101.60	69.85	9026020060400
0.2421		C	6.150	101.60	69.85	9026020061500
0.2461		D	6.250	101.60	69.85	9026020062500
0.2500	1/4	E	6.350	101.60	69.85	9026020063500
0.2559			6.500	104.78	73.03	9026020065000
0.2571		F	6.530	104.78	73.03	9026020065300
0.2610		G	6.630	104.78	73.03	9026020066300

Dec. inch	Diameter (d1)		l1 mm	l2 mm	EDP #	
	Fract. inch	Wire / letter				
0.2657	17/64	H	6.750	104.78	73.03	9026020067500
0.2717		I	6.900	104.78	73.03	9026020069000
0.2756			7.000	104.78	73.03	9026020070000
0.2768		J	7.030	104.78	73.03	9026020070300
0.2811	9/32	K	7.140	107.95	74.63	9026020071400
0.2902		L	7.370	107.95	74.63	9026020073700
0.2949		M	7.490	111.13	77.80	9026020074900
0.2953			7.500	111.13	77.80	9026020075000
0.2969	19/64		7.540	111.13	77.80	9026020075400
0.3020		N	7.670	111.13	77.80	9026020076700
0.3126	5/16		7.940	114.30	80.98	9026020079400
0.3150			8.000	114.30	80.98	9026020080000
0.3161		O	8.030	114.30	80.98	9026020080300
0.3228		P	8.200	117.48	84.15	9026020082000
0.3280	21/64		8.330	117.48	84.15	9026020083300
0.3319		Q	8.430	120.65	87.33	9026020084300
0.3346			8.500	120.65	87.33	9026020085000
0.3390		R	8.610	120.65	87.33	9026020086100
0.3437	11/32		8.730	120.65	87.33	9026020087300
0.3480		S	8.840	123.83	88.90	9026020088400
0.3543			9.000	123.83	88.90	9026020090000
0.3579		T	9.090	123.83	88.90	9026020090900
0.3594	23/64		9.130	123.83	88.90	9026020091300
0.3677		U	9.340	127.00	92.08	9026020093400
0.3740			9.500	127.00	92.08	9026020095000
0.3748	3/8		9.520	127.00	92.08	9026020095200
0.3772		V	9.580	127.00	92.08	9026020095800
0.3858		W	9.800	130.18	95.25	9026020098000
0.3906	25/64		9.920	130.18	95.25	9026020099200
0.3937			10.000	130.18	95.25	9026020100000
0.3969		X	10.080	130.18	95.25	9026020100800
0.4039		Y	10.260	133.35	98.43	9026020102600
0.4063	13/32		10.320	133.35	98.43	9026020103200
0.4130		Z	10.490	133.35	98.43	9026020104900
0.4134			10.500	133.35	98.43	9026020105000
0.4220	27/64		10.720	136.53	100.03	9026020107200
0.4331			11.000	139.70	103.20	9026020110000
0.4374	7/16		11.110	139.70	103.20	9026020111100
0.4528			11.500	142.88	106.36	9026020115000
0.4531	29/64		11.510	142.88	106.36	9026020115100
0.4689	15/32		11.910	146.05	109.55	9026020119100
0.4724			12.000	149.23	111.13	9026020120000
0.4843	31/64		12.300	149.23	111.13	9026020123000
0.4921			12.500	152.40	114.30	9026020125000
0.5000	1/2		12.700	152.40	114.30	9026020127000

Alternative Drill Series:

- #2601 Carbide, GT100, 5xD, 130 pt, Bright
- #732 Carbide, GP, 5xD, 118 pt, Bright
- #2464 Carbide, GP, 5xD, 118 pt, FIREX®
- #5522 PM Cobalt, GT500, 5xD, 130 pt, TIN

*Items listed in red are non-stocked items, and may take 2 - 6 weeks to receive

Micro drill (5xD)



TiAlN™ coated



External Coolant



Straight Shank

Speeds & Feeds
information pg 470

Series 3899

General Purpose

Carbide micro-precision drill, 4-facet point > 0.79 mm, reinforced straight shank

Cut Dia. = h7 tolerance range, Shank Dia. = h6

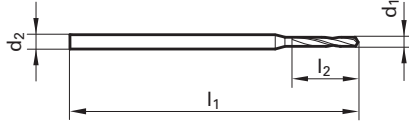

Application Materials:

- General Steels/Brass
- Universal Steels
- Stainless Steels
- Cast Iron

Diameter (d1)			mm	d2 mm	l1 mm	l2 mm	EDP #
Dec. inch	Fract. inch	Wire / letter					
0.0039			0.100	3.0	38.00	1.20	9038990001000
0.0043			0.110	3.0	38.00	1.20	9038990001100
0.0047			0.120	3.0	38.00	1.40	9038990001200
0.0051			0.130	3.0	38.00	1.40	9038990001300
0.0055			0.140	3.0	38.00	1.40	9038990001400
0.0059		97	0.150	3.0	38.00	2.00	9038990001500
0.0063		96	0.160	3.0	38.00	2.00	9038990001600
0.0067		95	0.170	3.0	38.00	2.00	9038990001700
0.0071		94	0.180	3.0	38.00	2.00	9038990001800
0.0075		93	0.190	3.0	38.00	2.00	9038990001900
0.0079		92	0.200	3.0	38.00	2.50	9038990002000
0.0083		91	0.210	3.0	38.00	2.50	9038990002100
0.0087		90	0.220	3.0	38.00	2.50	9038990002200
0.0091		89	0.230	3.0	38.00	2.50	9038990002300
0.0094		88	0.240	3.0	38.00	2.50	9038990002400
0.0098		87	0.250	3.0	38.00	3.00	9038990002500
0.0102			0.260	3.0	38.00	3.00	9038990002600
0.0106		86	0.270	3.0	38.00	3.00	9038990002700
0.0110		85	0.280	3.0	38.00	3.00	9038990002800
0.0114		84	0.290	3.0	38.00	3.00	9038990002900
0.0118			0.300	3.0	38.00	5.00	9038990003000
0.0122		83	0.310	3.0	38.00	5.00	9038990003100
0.0126		82	0.320	3.0	38.00	5.00	9038990003200
0.0130		81	0.330	3.0	38.00	5.00	9038990003300
0.0134		80	0.340	3.0	38.00	5.00	9038990003400
0.0138			0.350	3.0	38.00	6.00	9038990003500
0.0142			0.360	3.0	38.00	6.00	9038990003600
0.0146		79	0.370	3.0	38.00	6.00	9038990003700
0.0150			0.380	3.0	38.00	6.00	9038990003800
0.0154			0.390	3.0	38.00	6.00	9038990003900
0.0157		1/64	0.400	3.0	38.00	7.00	9038990004000
0.0161		78	0.410	3.0	38.00	7.00	9038990004100
0.0165			0.420	3.0	38.00	7.00	9038990004200
0.0169			0.430	3.0	38.00	7.00	9038990004300
0.0173			0.440	3.0	38.00	7.00	9038990004400
0.0177			0.450	3.0	38.00	7.00	9038990004500
0.0181		77	0.460	3.0	38.00	7.00	9038990004600
0.0185			0.470	3.0	38.00	7.00	9038990004700
0.0189			0.480	3.0	38.00	7.00	9038990004800
0.0193			0.490	3.0	38.00	7.00	9038990004900
0.0197			0.500	3.0	38.00	7.00	9038990005000
0.0201		76	0.510	3.0	38.00	7.00	9038990005100
0.0205			0.520	3.0	38.00	7.00	9038990005200
0.0209		75	0.530	3.0	38.00	7.00	9038990005300
0.0213			0.540	3.0	38.00	7.00	9038990005400
0.0217			0.550	3.0	38.00	7.00	9038990005500
0.0220			0.560	3.0	38.00	7.00	9038990005600
0.0224		74	0.570	3.0	38.00	7.00	9038990005700
0.0228			0.580	3.0	38.00	7.00	9038990005800
0.0232			0.590	3.0	38.00	7.00	9038990005900
0.0236			0.600	3.0	38.00	7.00	9038990006000
0.0240		73	0.610	3.0	38.00	7.00	9038990006100
0.0244			0.620	3.0	38.00	7.00	9038990006200
0.0248			0.630	3.0	38.00	7.00	9038990006300
0.0252		72	0.640	3.0	38.00	7.00	9038990006400

Diameter (d1)			mm	d2 mm	l1 mm	l2 mm	EDP #
Dec. inch	Fract. inch	Wire / letter					
0.0256			0.650	3.0	38.00	7.00	9038990006500
0.0260		71	0.660	3.0	38.00	7.00	9038990006600
0.0264			0.670	3.0	38.00	7.00	9038990006700
0.0268			0.680	3.0	38.00	7.00	9038990006800
0.0272			0.690	3.0	38.00	7.00	9038990006900
0.0276			0.700	3.0	38.00	8.00	9038990007000
0.0280		70	0.710	3.0	38.00	8.00	9038990007100
0.0283			0.720	3.0	38.00	8.00	9038990007200
0.0287			0.730	3.0	38.00	8.00	9038990007300
0.0291		69	0.740	3.0	38.00	8.00	9038990007400
0.0295			0.750	3.0	38.00	8.00	9038990007500
0.0299			0.760	3.0	38.00	8.00	9038990007600
0.0303			0.770	3.0	38.00	8.00	9038990007700
0.0307			0.780	3.0	38.00	8.00	9038990007800
0.0311		1/32	0.790	3.0	38.00	8.00	9038990007900
0.0315			0.800	3.0	38.00	10.00	9038990008000
0.0319		67	0.810	3.0	38.00	10.00	9038990008100
0.0323			0.820	3.0	38.00	10.00	9038990008200
0.0327			0.830	3.0	38.00	10.00	9038990008300
0.0331		66	0.840	3.0	38.00	10.00	9038990008400
0.0335			0.850	3.0	38.00	10.00	9038990008500
0.0339			0.860	3.0	38.00	10.00	9038990008600
0.0343			0.870	3.0	38.00	10.00	9038990008700
0.0346			0.880	3.0	38.00	10.00	9038990008800
0.0350		65	0.890	3.0	38.00	10.00	9038990008900
0.0354			0.900	3.0	38.00	10.00	9038990009000
0.0358		64	0.910	3.0	38.00	10.00	9038990009100
0.0362			0.920	3.0	38.00	10.00	9038990009200
0.0366			0.930	3.0	38.00	10.00	9038990009300
0.0370		63	0.940	3.0	38.00	10.00	9038990009400
0.0374			0.950	3.0	38.00	10.00	9038990009500
0.0378			0.960	3.0	38.00	10.00	9038990009600
0.0382		62	0.970	3.0	38.00	10.00	9038990009700
0.0386			0.980	3.0	38.00	10.00	9038990009800
0.0390		61	0.990	3.0	38.00	10.00	9038990009900
0.0394			1.000	3.0	38.00	10.00	9038990010000
0.0398			1.010	3.0	38.00	10.00	9038990010100
0.0402		60	1.020	3.0	38.00	10.00	9038990010200
0.0406			1.030	3.0	38.00	10.00	9038990010300
0.0409		59	1.040	3.0	38.00	10.00	9038990010400
0.0413			1.050	3.0	38.00	10.00	9038990010500
0.0417			1.060	3.0	38.00	10.00	9038990010600
0.0421		58	1.070	3.0	38.00	10.00	9038990010700
0.0425			1.080	3.0	38.00	10.00	9038990010800
0.0429		57	1.090	3.0	38.00	10.00	9038990010900
0.0433			1.100	3.0	38.00	10.00	9038990011000
0.0437			1.110	3.0	38.00	10.00	9038990011100
0.0441			1.120	3.0	38.00	10.00	9038990011200
0.0445			1.130	3.0	38.00	10.00	9038990011300
0.0449			1.140	3.0	38.00	10.00	9038990011400
0.0453			1.150	3.0	38.00	10.00	9038990011500
0.0457			1.160	3.0	38.00	10.00	9038990011600
0.0461			1.170	3.0	38.00	10.00	9038990011700
0.0465		56	1.180	3.0	38.00	10.00	9038990011800
0.0469		3/64	1.190	3.0	38.00	10.00	9038990011900

Series 3899

Speeds & Feeds information pg 470

Diameter (d1)				d2 mm	l1 mm	l2 mm	EDP #
Dec. inch	Fract. inch	Wire / letter	mm				
0.0472			1.200	3.0	38.00	10.00	9038990012000
0.0476			1.210	3.0	38.00	10.00	9038990012100
0.0480			1.220	3.0	38.00	10.00	9038990012200
0.0484			1.230	3.0	38.00	10.00	9038990012300
0.0488			1.240	3.0	38.00	10.00	9038990012400
0.0492			1.250	3.0	38.00	10.00	9038990012500
0.0496			1.260	3.0	38.00	10.00	9038990012600
0.0500			1.270	3.0	38.00	10.00	9038990012700
0.0504			1.280	3.0	38.00	10.00	9038990012800
0.0508			1.290	3.0	38.00	10.00	9038990012900
0.0512			1.300	3.0	38.00	10.00	9038990013000
0.0516			1.310	3.0	38.00	10.00	9038990013100
0.0520		55	1.320	3.0	38.00	10.00	9038990013200
0.0524			1.330	3.0	38.00	10.00	9038990013300
0.0528			1.340	3.0	38.00	10.00	9038990013400
0.0531			1.350	3.0	38.00	10.00	9038990013500
0.0535			1.360	3.0	38.00	10.00	9038990013600
0.0539			1.370	3.0	38.00	10.00	9038990013700
0.0543			1.380	3.0	38.00	10.00	9038990013800
0.0547			1.390	3.0	38.00	10.00	9038990013900
0.0551		54	1.400	3.0	38.00	10.00	9038990014000
0.0555			1.410	3.0	38.00	10.00	9038990014100
0.0559			1.420	3.0	38.00	10.00	9038990014200
0.0563			1.430	3.0	38.00	10.00	9038990014300
0.0567			1.440	3.0	38.00	10.00	9038990014400
0.0571			1.450	3.0	38.00	10.00	9038990014500
0.0575			1.460	3.0	38.00	10.00	9038990014600
0.0579			1.470	3.0	38.00	10.00	9038990014700
0.0583			1.480	3.0	38.00	10.00	9038990014800
0.0587			1.490	3.0	38.00	10.00	9038990014900
0.0591			1.500	3.0	38.00	10.00	9038990015000
0.0594			1.510	3.0	38.00	10.00	9038990015100
0.0598			1.520	3.0	38.00	10.00	9038990015200
0.0602			1.530	3.0	38.00	10.00	9038990015300
0.0606			1.540	3.0	38.00	10.00	9038990015400
0.0610			1.550	3.0	38.00	10.00	9038990015500
0.0614			1.560	3.0	38.00	10.00	9038990015600
0.0618			1.570	3.0	38.00	10.00	9038990015700
0.0622			1.580	3.0	38.00	10.00	9038990015800
0.0626	1/16		1.590	3.0	38.00	10.00	9038990015900
0.0630			1.600	3.0	38.00	12.00	9038990016000
0.0634		52	1.610	3.0	38.00	12.00	9038990016100
0.0638			1.620	3.0	38.00	12.00	9038990016200
0.0642			1.630	3.0	38.00	12.00	9038990016300
0.0646			1.640	3.0	38.00	12.00	9038990016400
0.0650			1.650	3.0	38.00	12.00	9038990016500
0.0654			1.660	3.0	38.00	12.00	9038990016600
0.0657			1.670	3.0	38.00	12.00	9038990016700
0.0661			1.680	3.0	38.00	12.00	9038990016800
0.0665			1.690	3.0	38.00	12.00	9038990016900
0.0669		51	1.700	3.0	38.00	12.00	9038990017000
0.0673			1.710	3.0	38.00	12.00	9038990017100
0.0677			1.720	3.0	38.00	12.00	9038990017200
0.0681			1.730	3.0	38.00	12.00	9038990017300
0.0685			1.740	3.0	38.00	12.00	9038990017400

Diameter (d1)				d2 mm	l1 mm	l2 mm	EDP #
Dec. inch	Fract. inch	Wire / letter	mm				
0.0689			1.750	3.0	38.00	12.00	9038990017500
0.0693			1.760	3.0	38.00	12.00	9038990017600
0.0697			1.770	3.0	38.00	12.00	9038990017700
0.0701			1.780	3.0	38.00	12.00	9038990017800
0.0705			1.790	3.0	38.00	12.00	9038990017900
0.0709			1.800	3.0	38.00	12.00	9038990018000
0.0713			1.810	3.0	38.00	12.00	9038990018100
0.0717			1.820	3.0	38.00	12.00	9038990018200
0.0720			1.830	3.0	38.00	12.00	9038990018300
0.0724			1.840	3.0	38.00	12.00	9038990018400
0.0728		49	1.850	3.0	38.00	12.00	9038990018500
0.0732			1.860	3.0	38.00	12.00	9038990018600
0.0736			1.870	3.0	38.00	12.00	9038990018700
0.0740			1.880	3.0	38.00	12.00	9038990018800
0.0744			1.890	3.0	38.00	12.00	9038990018900
0.0748			1.900	3.0	38.00	12.00	9038990019000
0.0752			1.910	3.0	38.00	12.00	9038990019100
0.0756			1.920	3.0	38.00	12.00	9038990019200
0.0760		48	1.930	3.0	38.00	12.00	9038990019300
0.0764			1.940	3.0	38.00	12.00	9038990019400
0.0768			1.950	3.0	38.00	12.00	9038990019500
0.0772			1.960	3.0	38.00	12.00	9038990019600
0.0776			1.970	3.0	38.00	12.00	9038990019700
0.0780	5/64		1.980	3.0	38.00	12.00	9038990019800
0.0783		47	1.990	3.0	38.00	12.00	9038990019900
0.0787			2.000	3.0	38.00	12.00	9038990020000
0.0807			2.050	3.0	38.00	12.00	9038990020500
0.0827			2.100	3.0	38.00	12.00	9038990021000
0.0846			2.150	3.0	38.00	12.00	9038990021500
0.0866			2.200	3.0	38.00	12.00	9038990022000
0.0886			2.250	3.0	38.00	12.00	9038990022500
0.0906			2.300	3.0	38.00	12.00	9038990023000
0.0925			2.350	3.0	38.00	12.00	9038990023500
0.0945			2.400	3.0	38.00	12.00	9038990024000
0.0965			2.450	3.0	38.00	12.00	9038990024500
0.0984			2.500	3.0	38.00	12.00	9038990025000
0.1004			2.550	3.0	38.00	12.00	9038990025500
0.1024			2.600	3.0	38.00	12.00	9038990026000
0.1043			2.650	3.0	38.00	12.00	9038990026500
0.1063			2.700	3.0	38.00	12.00	9038990027000
0.1083			2.750	3.0	38.00	12.00	9038990027500
0.1102			2.800	3.0	38.00	12.00	9038990028000
0.1122			2.850	3.0	38.00	12.00	9038990028500
0.1142			2.900	3.0	38.00	12.00	9038990029000
0.1161		32	2.950	3.0	38.00	12.00	9038990029500
0.1181			3.000	3.0	38.00	12.00	9038990030000

Alternative Drill Series:
 #6401 Carbide, 5xD, 135 pt., Super-A™

*Items listed in red are non-stocked items, and may take 2 - 6 weeks to receive

HT 800 W/P

Interchangeable Insert
Drilling System



HT 800 WP Interchangeable Insert Drills

The new HT 800 WP interchangeable drilling system from Guhring - High-performance, cost-efficient drilling for diameters from 11.00 to 25.5mm (29/64 to 1.0"). Features include:

- A Extended tool life**
Thanks to special micro-machined cutting edges and an application-oriented surface finish the interchangeable inserts of the HT 800 WP drilling system are especially wear resistant. The holders of the HT 800 WP drilling system also possess a very high wear resistance, due to the optimized holder substrate and nickel plated surface. Incremental holder sizes in steps of 0.5 mm also lead to less wear on the holder body.
- B Optimized chip flow**
Thanks to their flute cross section the holders of the HT 800 WP drilling system ensure optimal chip evacuation from the hole, even with deeper drilling depths.
- C Perfect coolant delivery**
Perfect coolant delivery to the cutting surface is ensured by coolant ducts with maximum cross section, exiting in the flutes. This aids in both reducing the heat at the cutting edge as well as facilitating maximum chip evacuation.
- D Highly accurate and rigid insert seat**
The accurate insert seat enables insert changes in the machine in only a few simple steps with a standard Torx screw driver. Thanks to the optimized material for the HT 800 WP holders insert seat wear is much lower than with conventional tooling, allowing for more frequent insert changes without having to replace the holder. The clamping screws with screw lock ensure a secure holding of the interchangeable insert in the holder even with machines subject to high levels of vibrations.

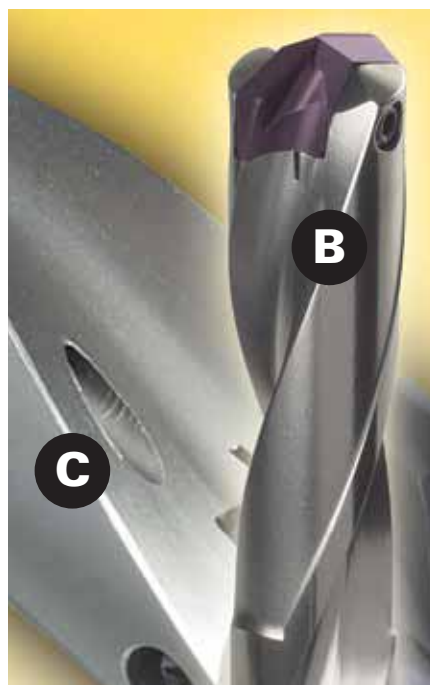

Rigid holders

The close stepped diameter jumps of 0.5 mm with the holder sizes reduce wear, plus, through the better guidance of the tool in the hole they also increase the rigidity of the HT 800 WP drilling system. This allows for longer tool life as well as improved workpiece surfaces. All holders are offered with a metric or fractional inch size option.



Overview

Countersink inserts

Series	7645	7632	7635
Surface finish	TiN coated	TiAlN coated	Bright finish
Type	CPGT ... R	CPGW ...	CPGT ... R
Applications	steels	cast iron	aluminum
			

Drill inserts

Series	4111	4112	4113	4114	4115
Surface finish	nano-A® coated	nano-FIREX® coated	FIREX® coated	Bright finish	nano-A® coated
Point geometry	2-facet	2-facet	2-facet	relieved cone	relieved cone
Point angle	145°	140°	140°	140°	140°
Tolerance	m7	h7	m7	h7	h7
Applications	Pilot drilling	steels	cast iron	aluminum	stainless steel
					

Drill holders

Series	4105	4106	4107	4108	4109	4110
Drilling depth	1xD w/countersink	1.5xD	3xD	5xD	7xD	10xD
						

*Items listed in red are non-stocked items, and may take 2 - 6 weeks to receive

HT 800 WP Interchangeable Insert Drills

Carbide inserts with material-specific attributes

Four distinct geometries are available with the HT 800 WP drilling system, and they are completely interchangeable with any style drill body. The unique locating post and set screw design assures quick and accurate tool changes. The high performance insert designs allow for maximum penetration rates that far exceed conventional spade drills or dual insert drill designs.

① Choose your diameter (metric or inch)

② Choose the appropriate insert for your workpiece material

③ Note the holder size for that insert diameter; select a holder (1.5xD to 10xD) from the holder pages.

①					②				③	
Dia	Dia	h	b	l4	Series 4115 nano-A	Series 4114 bright	Series 4113 FIREX®	Series 4112 nano-FIREX®	Drill Holder Size	Pilot Drill Holder Size
fract.	mm	mm	mm	mm	EDP No.	EDP No.	EDP No.	EDP No.		
	11.00 11.20	7.5	4.5	2.1	9041150110000 9041150112000	9041140110000 9041140112000	9041130110000 9041130112000	9041120110000 9041120112000	110	110
29/64	11.50 11.51 11.70 11.80	7.5	4.5	2.1 2.1 2.1 2.1	9041150115000 9041150115100 9041150117000 9041150118000	9041140115000 9041140115100 9041140117000 9041140118000	9041130115000 9041130115100 9041130117000 9041130118000	9041120115000 9041120115100 9041120117000 9041120118000	115	110
15/32	11.91			2.2	9041150119100	9041140119100	9041130119100	9041120119100		
	12.00 12.10 12.20 12.30	7.7	5.0	2.2 2.2 2.2 2.2	9041150120000 9041150121000 9041150122000 9041150123000	9041140120000 9041140121000 9041140122000 9041140123000	9041130120000 9041130121000 9041130122000 9041130123000	9041120120000 9041120121000 9041120122000 9041120123000	120	120
31/64	12.50 12.60 12.70 12.80 12.90	7.7	5.0	2.3 2.3 2.3 2.3 2.3	9041150125000 9041150126000 9041150127000 9041150128000 9041150129000	9041140125000 9041140126000 9041140127000 9041140128000 9041140129000	9041130125000 9041130126000 9041130127000 9041130128000 9041130129000	9041120125000 9041120126000 9041120127000 9041120128000 9041120129000	125	120
	13.00 13.10 13.49	8.5	5.5	2.4 2.4 2.4	9041150130000 9041150131000 9041150134900	9041140130000 9041140131000 9041140134900	9041130130000 9041130131000 9041130134900	9041120130000 9041120131000 9041120134900	130	130
33/64	13.50 13.60 13.70 13.80 13.89	8.5	5.5	2.4 2.4 2.4 2.5 2.5	9041150135000 9041150136000 9041150137000 9041150138000 9041150138900	9041140135000 9041140136000 9041140137000 9041140138000 9041140138900	9041130135000 9041130136000 9041130137000 9041130138000 9041130138900	9041120135000 9041120136000 9041120137000 9041120138000 9041120138900	135	130
35/64	14.00 14.10 14.29 14.40	9.6	6.0	2.5 2.5 2.6 2.6	9041150140000 9041150141000 9041150142900 9041150144000	9041140140000 9041140141000 9041140142900 9041140144000	9041130140000 9041130141000 9041130142900 9041130144000	9041120140000 9041120141000 9041120142900 9041120144000	140	140
	14.50 14.60 14.68 14.70 14.80	9.6	6.0	2.6 2.7 2.7 2.7 2.7	9041150145000 9041150146000 9041150146800 9041150147000 9041150148000	9041140145000 9041140146000 9041140146800 9041140147000 9041140148000	9041130145000 9041130146000 9041130146800 9041130147000 9041130148000	9041120145000 9041120146000 9041120146800 9041120147000 9041120148000	145	140
37/64	15.00 15.08 15.10 15.20 15.30 15.48	9.8	6.0	2.7 2.7 2.7 2.8 2.8 2.8	9041150150000 9041150150800 9041150151000 9041150152000 9041150153000 9041150154800	9041140150000 9041140150800 9041140151000 9041140152000 9041140153000 9041140154800	9041130150000 9041130150800 9041130151000 9041130152000 9041130153000 9041130154800	9041120150000 9041120150800 9041120151000 9041120152000 9041120153000 9041120154800	150	140
39/64	15.50 15.60 15.70 15.80 15.87	9.8	6.0	2.8 2.9 2.9 2.9 2.9	9041150155000 9041150156000 9041150157000 9041150158000 9041150158700	9041140155000 9041140156000 9041140157000 9041140158000 9041140158700	9041130155000 9041130156000 9041130157000 9041130158000 9041130158700	9041120155000 9041120156000 9041120157000 9041120158000 9041120158700	155	140
5/8	16.00 16.27	11.0	7.0	2.9 3.0	9041150160000 9041150162700	9041140160000 9041140162700	9041130160000 9041130162700	9041120160000 9041120162700	160	160
41/64										

Carbide Inserts for Drilling

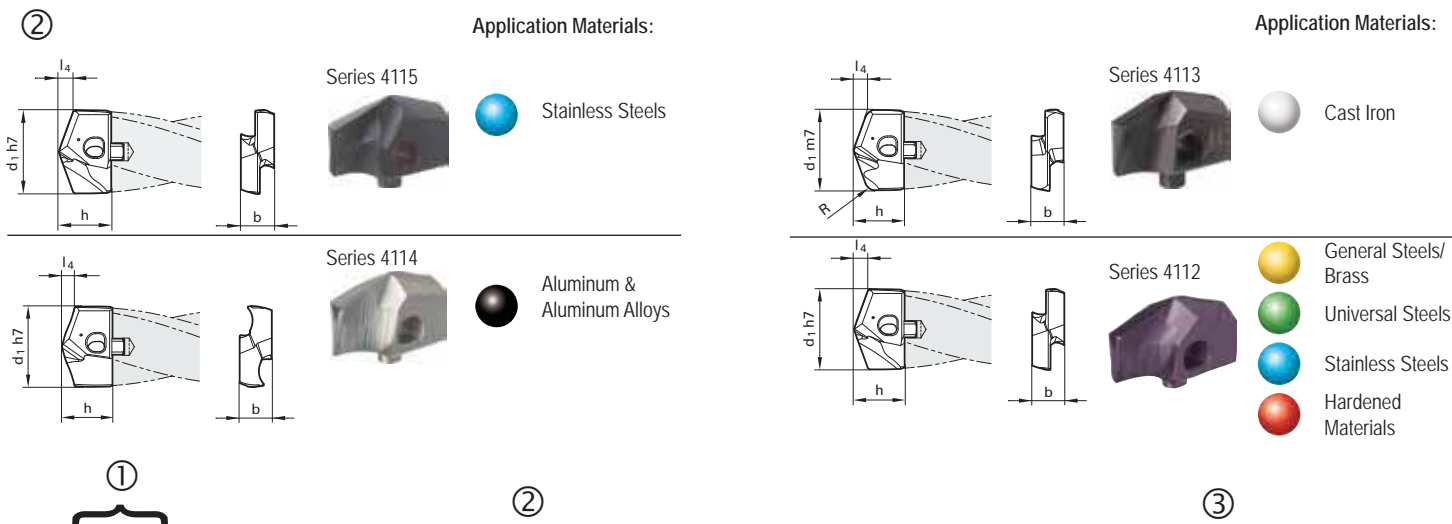

Dia fract.	Dia mm	h mm	b mm	l ₄ mm	Series 4115	Series 4114	Series 4113	Series 4112	Drill Holder Size	Pilot Drill Holder Size
					nano-A	bright	FIREX®	nano-FIREX®		
					EDP No.	EDP No.	EDP No.	EDP No.		
21/32	16.50	11.0	7.0	3.0	9041150165000	9041140165000	9041130165000	9041120165000	165	160
	16.67				9041150166700	9041140166700	9041130166700	9041120166700		
43/64	17.00	11.0	7.0	3.1	9041150170000	9041140170000	9041130170000	9041120170000	170	160
	17.07			3.1	9041150170700	9041140170700	9041130170700	9041120170700		
	17.46			3.1	9041150174600	9041140174600	9041130174600	9041120174600		
45/64	17.50	11.0	7.0	3.2	9041150175000	9041140175000	9041130175000	9041120175000	175	160
	17.60			3.2	9041150176000	9041140176000	9041130176000	9041120176000		
	17.86			3.3	9041150178600	9041140178600	9041130178600	9041120178600		
23/32	18.00	12.6	8.0	3.3	9041150180000	9041140180000	9041130180000	9041120180000	180	180
	18.26			3.3	9041150182600	9041140182600	9041130182600	9041120182600		
	18.50			12.6	8.0	3.4	9041150185000	9041140185000		
18.65		3.4	9041150186500			9041140186500	9041130186500	9041120186500		
3/4	19.00	12.6	8.0	3.5	9041150190000	9041140190000	9041130190000	9041120190000	190	180
	19.05			3.5	9041150190500	9041140190500	9041130190500	9041120190500		
	19.45			3.5	9041150194500	9041140194500	9041130194500	9041120194500		
25/32	19.50	12.6	8.0	3.5	9041150195000	9041140195000	9041130195000	9041120195000	195	180
	19.60			3.6	9041150196000	9041140196000	9041130196000	9041120196000		
	19.84			3.6	9041150198400	9041140198400	9041130198400	9041120198400		
51/64	20.00	13.9	9.0	3.6	9041150200000	9041140200000	9041130200000	9041120200000	200	200
	20.24			3.6	9041150202400	9041140202400	9041130202400	9041120202400		
	20.50			13.9	9.0	3.7	9041150205000	9041140205000		
20.64		3.8	9041150206400			9041140206400	9041130206400	9041120206400		
53/64	21.00	13.9	9.0	3.8	9041150210000	9041140210000	9041130210000	9041120210000	210	200
	21.03			3.8	9041150210300	9041140210300	9041130210300	9041120210300		
	21.10			3.9	9041150211000	9041140211000	9041130211000	9041120211000		
	21.43			3.9	9041150214300	9041140214300	9041130214300	9041120214300		
55/64	21.50	13.9	9.0	3.9	9041150215000	9041140215000	9041130215000	9041120215000	215	200
	21.83			4.0	9041150218300	9041140218300	9041130218300	9041120218300		
	22.00			15.3	10.0	4.0	9041150220000	9041140220000		
22.22		4.0	9041150222200			9041140222200	9041130222200	9041120222200		
57/64	22.50	15.3	10.0	4.1	9041150225000	9041140225000	9041130225000	9041120225000	225	220
	22.62			4.1	9041150226200	9041140226200	9041130226200	9041120226200		
	23.00			15.3	10.0	4.2	9041150230000	9041140230000		
23.02		4.2	9041150230200			9041140230200	9041130230200	9041120230200		
23.42		4.3	9041150234200			9041140234200	9041130234200	9041120234200		
15/16	23.50	15.3	10.0	4.3	9041150235000	9041140235000	9041130235000	9041120235000	235	220
	23.81			4.3	9041150238100	9041140238100	9041130238100	9041120238100		
	24.00			15.8	11.0	4.4	9041150240000	9041140240000		
24.10		4.4	9041150241000			9041140241000	9041130241000	9041120241000		
24.21		4.4	9041150242100			9041140242100	9041130242100	9041120242100		
31/32	24.50	15.8	11.0	4.5	9041150245000	9041140245000	9041130245000	9041120245000	245	240
	24.61			4.5	9041150246100	9041140246100	9041130246100	9041120246100		
	25.00			15.8	11.0	4.5	9041150250000	9041140250000		
25.40		4.6	9041150254000			9041140254000	9041130254000	9041120254000		
25.50		4.6	9041150255000			9041140255000	9041130255000	9041120255000		

*Items listed in red are non-stocked items, and may take 2 - 6 weeks to receive

HT 800 WP Interchangeable Insert Drills

Holders for drilling - 1.5 x D, 3 x D and 5 x D
 HSS, coolant fed, nickel treated

③ *11 dimensions listed include insert series 4112, 4113, 4114, and 4115 only. Pilot insert series 4111 has different h and l4 dimensions

Holder Size	d1 Insert Range mm	d2 mm	d2 in	d3 mm	l3 mm	Series 4106 (1.5xD)			Series 4107 (3xD)			Series 4108 (5xD)		
						EDP No.	l1* mm	l2 mm	EDP No.	l1* mm	l2 mm	EDP No.	l1* mm	l2 mm
110	11.00-11.49	12.00		10.70	45.00	9041060110000			9041070110000			9041080110000		
	11.00-11.49	12.70	1/2	10.70		9041060110050	84.00	19.30	9041070110050	101.00	36.60	9041080110050	124.00	59.60
115	11.50-11.99	12.00		11.20	45.00	9041060115000			9041070115000			9041080115000		
	11.50-11.99	12.70	1/2	11.20		9041060115050	85.00	20.10	9041070115050	103.00	38.10	9041080115050	127.00	62.10
120	12.00-12.49	12.00		11.70	45.00	9041060120000			9041070120000			9041080120000		
	12.00-12.49	12.70	1/2	11.70		9041060120050	87.00	21.00	9041070120050	106.00	39.70	9041080120050	131.00	64.70
125	12.50-12.99	14.00		12.20	45.00	9041060125000			9041070125000			9041080125000		
	12.50-12.99	15.875	5/8	12.20		9041060125050	89.00	21.90	9041070125050	108.00	41.30	9041080125050	134.00	67.30
130	13.00-13.49	14.00		12.70	45.00	9041060130000			9041070130000			9041080130000		
	13.00-13.49	15.875	5/8	12.70		9041060130050	90.00	22.60	9041070130050	110.00	42.90	9041080130050	137.00	69.90
135	13.50-13.99	14.00		13.20	45.00	9041060135000			9041070135000			9041080135000		
	13.50-13.99	15.875	5/8	13.20		9041060135050	92.00	23.60	9041070135050	113.00	44.60	9041080135050	141.00	72.60
140	14.00-14.49	14.00		13.70	45.00	9041060140000			9041070140000			9041080140000		
	14.00-14.49	15.875	5/8	13.70		9041060140050	93.00	24.50	9041070140050	115.00	46.20	9041080140050	144.00	75.20
145	14.50-14.99	16.00		14.20	48.00	9041060145000			9041070145000			9041080145000		
	14.50-14.99	15.875	5/8	14.20		9041060145050	98.00	25.30	9041070145050	120.00	47.80	9041080145050	150.00	77.80
150	15.00-15.49	16.00		14.70	48.00	9041060150000			9041070150000			9041080150000		
	15.00-15.49	15.875	5/8	14.70		9041060150050	100.00	26.10	9041070150050	123.00	49.30	9041080150050	154.00	80.30
155	15.50-15.99	16.00		15.20	48.00	9041060155000			9041070155000			9041080155000		
	15.50-15.99	15.875	5/8	15.20		9041060155050	101.00	27.00	9041070155050	125.00	50.90	9041080155050	157.00	82.90
160	16.00-16.49	16.00		15.70	48.00	9041060160000			9041070160000			9041080160000		
	16.00-16.49	15.875	5/8	15.70		9041060160050	102.00	27.80	9041070160050	127.00	52.90	9041080160050	160.00	85.90
165	16.50-16.99	18.00		16.20	48.00	9041060165000			9041070165000			9041080165000		
	16.50-16.99	19.05	3/4	16.20		9041060165050	105.00	28.70	9041070165050	130.00	54.10	9041080165050	164.00	88.10
170	17.00-17.49	18.00		16.70	48.00	9041060170000			9041070170000			9041080170000		
	17.00-17.49	19.05	3/4	16.70		9041060170050	106.00	29.60	9041070170050	132.00	55.80	9041080170050	167.00	90.80
175	17.50-17.99	18.00		17.20	48.00	9041060175000			9041070175000			9041080175000		
	17.50-17.99	19.05	3/4	17.20		9041060175050	107.00	30.40	9041070175050	134.00	57.40	9041080175050	170.00	93.40
180	18.00-18.49	18.00		17.70	48.00	9041060180000			9041070180000			9041080180000		
	18.00-18.49	19.05	3/4	17.70		9041060180050	109.00	31.20	9041070180050	137.00	58.90	9041080180050	174.00	95.90
185	18.50-18.99	20.00		18.20	50.00	9041060185000			9041070185000			9041080185000		
	18.50-18.99	19.05	3/4	18.20		9041060185050	113.00	32.10	9041070185050	141.00	60.50	9041080185050	179.00	98.50
190	19.00-19.49	20.00		18.70	50.00	9041060190000			9041070190000			9041080190000		
	19.00-19.49	19.05	3/4	18.70		9041060190050	114.00	32.90	9041070190050	143.00	62.10	9041080190050	182.00	101.10
195	19.50-19.99	20.00		19.20	50.00	9041060195000			9041070195000			9041080195000		
	19.50-19.99	19.05	3/4	19.20		9041060195050	116.00	33.70	9041070195050	146.00	63.70	9041080195050	186.00	103.70
200	20.00-20.49	20.00		19.70	50.00	9041060200000			9041070200000			9041080200000		
	20.00-20.49	19.05	3/4	19.70		9041060200050	117.00	34.60	9041070200050	148.00	65.30	9041080200050	189.00	106.30
205	20.50-20.99	25.00		20.20	56.00	9041060205000			9041070205000			9041080205000		
	20.50-20.99	25.40	1	20.20		9041060205050	128.00	35.50	9041070205050	159.00	67.00	9041080205050	201.00	109.00
210	21.00-21.49	25.00		20.70	56.00	9041060210000			9041070210000			9041080210000		
	21.00-21.49	25.40	1	20.70		9041060210050	129.00	36.40	9041070210050	161.00	68.60	9041080210050	204.00	111.60
215	21.50-21.99	25.00		21.20	56.00	9041060215000			9041070215000			9041080215000		
	21.50-21.99	25.40	1	21.20		9041060215050	130.00	37.20	9041070215050	163.00	70.10	9041080215050	207.00	114.10
220	22.00-22.49	25.00		21.70	56.00	9041060220000			9041070220000			9041080220000		
	22.00-22.49	25.40	1	21.70		9041060220050	131.00	38.00	9041070220050	165.00	71.70	9041080220050	210.00	116.70
225	22.50-22.99	25.00		22.20	56.00	9041060225000			9041070225000			9041080225000		
	22.50-22.99	25.40	1	22.20		9041060225050	134.00	38.90	9041070225050	168.00	73.30	9041080225050	214.00	119.30
230	23.00-23.49	25.00		22.70	56.00	9041060230000			9041070230000			9041080230000		
	23.00-23.49	25.40	1	22.70		9041060230050	135.00	39.80	9041070230050	170.00	74.90	9041080230050	217.00	121.90
235	23.50-23.99	25.00		23.20	56.00	9041060235000			9041070235000			9041080235000		
	23.50-23.99	25.40	1	23.20		9041060235050	137.00	40.60	9041070235050	173.00	76.50	9041080235050	221.00	124.50

Holders

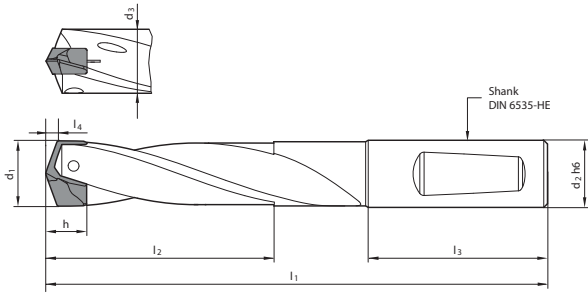

Twist Drills

③

Holder Size	d1 Insert Range mm	d2 mm	d2 in	d3 mm	l3 mm	Series 4106 (1.5xD)			Series 4107 (3xD)			Series 4108 (5xD)		
						EDP No.	l1* mm	l2 mm	EDP No.	l1* mm	l2 mm	EDP No.	l1* mm	l2 mm
240	24.00-24.49	25.00		23.70	56.00	9041060240000	138.00	41.50	9041070240000	175.00	78.10	9041080240000	224.00	127.10
	24.00-24.49	25.40	1	23.70		9041060240050			9041070240050			9041080240050		
245	24.50-24.99	25.00		24.20	56.00	9041060245000	140.00	42.30	9041070245000	177.00	79.70	9041080245000	227.00	129.70
	24.50-24.99	25.40	1	24.20		9041060245050			9041070245050			9041080245050		
250	25.00-25.49	25.00		24.70	56.00	9041060250000	142.00	43.20	9041070250000	180.00	81.30	9041080250000	231.00	132.30
	25.00-25.49	25.40	1	24.70		9041060250050			9041070250050			9041080250050		
255	25.50-25.99	32.00		25.20	60.00	9041060255000	148.00	44.00	9041070255000	187.00	82.90	9041080255000	239.00	134.90
	25.50-25.99	31.75	1 1/4	25.20		9041060255050			9041070255050			9041080255050		
260	26.00-26.49	32.00		25.70	60.00	9041060260000	151.00	44.30	9041070260000	191.00	84.00	9041080260000	244.00	137.00
	26.00-26.49	31.75	1 1/4	25.70		9041060260050			9041070260050			9041080260050		
265	26.50-26.99	32.00		26.20	60.00	9041060265000	153.00	45.10	9041070265000	193.00	86.10	9041080265000	247.00	140.00
	26.50-26.99	31.75	1 1/4	26.20		9041060265050			9041070265050			9041080265050		
270	27.00-27.49	32.00		26.70	60.00	9041060270000	155.00	46.00	9041070270000	196.00	87.20	9041080270000	251.00	142.00
	27.00-27.49	31.75	1 1/4	26.70		9041060270050			9041070270050			9041080270050		
275	27.50-27.99	32.00		27.20	60.00	9041060275000	156.00	46.80	9041070275000	198.00	88.90	9041080275000	254.00	144.80
	27.50-27.99	31.75	1 1/4	27.20		9041060275050			9041070275050			9041080275050		
280	28.00-28.49	32.00		27.70	60.00	9041060280000	157.00	47.70	9041070280000	200.00	90.50	9041080280000	257.00	147.40
	28.00-28.49	31.75	1 1/4	27.70		9041060280050			9041070280050			9041080280050		
285	28.50-28.99	32.00		28.20	60.00	9041060285000	159.00	48.50	9041070285000	202.00	92.50	9041080285000	260.00	150.40
	28.50-28.99	31.75	1 1/4	28.20		9041060285050			9041070285050			9041080285050		
290	29.00-29.49	32.00		28.70	60.00	9041060290000	161.00	49.40	9041070290000	205.00	94.60	9041080290000	264.00	153.50
	29.00-29.49	31.75	1 1/4	28.70		9041060290050			9041070290050			9041080290050		
295	29.50-29.99	32.00		29.20	60.00	9041060295000	162.00	50.20	9041070295000	207.00	95.10	9041080295000	267.00	155.10
	29.50-29.99	31.75	1 1/4	29.20		9041060295050			9041070295050			9041080295050		
300	30.00-30.49	32.00		29.70	60.00	9041060300000	164.00	50.90	9041070300000	210.00	96.70	9041080300000	271.00	157.60
	30.00-30.49	31.75	1 1/4	29.70		9041060300050			9041070300050			9041080300050		
305	30.50-30.99	32.00		30.20	60.00	9041060305000	166.00	51.70	9041070305000	212.00	98.30	9041080305000	274.00	160.20
	30.50-30.99	31.75	1 1/4	30.20		9041060305050			9041070305050			9041080305050		
310	31.00-31.49	32.00		30.70	60.00	9041060310000	167.00	52.60	9041070310000	214.00	99.80	9041080310000	277.00	162.80
	31.00-31.49	31.75	1 1/4	30.70		9041060310050			9041070310050			9041080310050		
315	31.50-31.99	32.00		31.20	60.00	9041060315000	168.00	53.40	9041070315000	216.00	101.40	9041080315000	280.00	165.40
	31.50-31.99	31.75	1 1/4	31.20		9041060315050			9041070315050			9041080315050		
320	32.00-32.99	32.00		31.70	60.00	9041060320000	172.00	55.10	9041070320000	221.00	104.60	9041080320000	287.00	170.60
	32.00-32.99	31.75	1 1/4	31.70		9041060320050			9041070320050			9041080320050		
330	33.00-33.99	32.00		32.70	60.00	9041060330000	175.00	56.80	9041070330000	226.00	107.80	9041080330000	294.00	175.80
	33.00-33.99	31.75	1 1/4	32.70		9041060330050			9041070330050			9041080330050		
340	34.00-34.99	32.00		33.70	60.00	9041060340050	178.00	58.50	9041070340050	230.00	111.00	9041080340050	300.00	181.00
	34.00-34.99	31.75	1 1/4	33.70		9041060340050			9041070340050			9041080340050		
350	35.00-35.99	32.00		34.70	60.00	9041060350000	181.00	60.20	9041070350000	235.00	114.20	9041080350000	307.00	186.20
	35.00-35.99	31.75	1 1/4	34.70		9041060350050			9041070350050			9041080350050		
360	36.00-36.99	32.00		35.70	60.00	9041060360000	184.00	61.80	9041070360000	240.00	117.30	9041080360000	314.00	191.30
	36.00-36.99	31.75	1 1/4	35.70		9041060360050			9041070360050			9041080360050		
370	37.00-37.99	32.00		36.70	60.00	9041060370000	188.00	63.50	9041070370000	245.00	120.50	9041080370000	321.00	196.50
	37.00-37.99	31.75	1 1/4	36.70		9041060370050			9041070370050			9041080370050		
380	38.00-38.99	32.00		37.70	60.00	9041060380000	191.00	65.20	9041070380000	249.00	123.70	9041080380000	327.00	201.70
	38.00-38.99	31.75	1 1/4	37.70		9041060380050			9041070380050			9041080380050		
390	39.00-40.00	32.00		38.70	60.00	9041060390000	194.00	66.90	9041070390000	254.00	126.90	9041080390000	334.00	206.90
	39.00-40.00	31.75	1 1/4	38.70		9041060390050			9041070390050			9041080390050		

*Items listed in red are non-stocked items, and may take 2 - 6 weeks to receive

HT 800 WP Interchangeable Insert Drills

Extra length holders for drilling - 7 x D and 10 x D
HSS, coolant fed, nickel treated

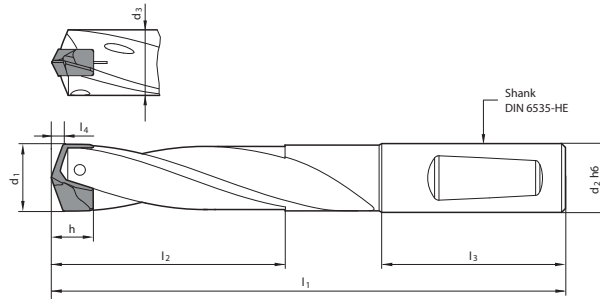

③ *l1 dimensions listed include insert series 4112, 4113, 4114, and 4115 only. Pilot insert series 4111 has different h and l4 dimensions

Holder Size	d1 Insert Range mm	d2 mm	d2 in	d3 mm	l3 mm	Series 4109 (7xD)			Series 4110 (10xD)		
						EDP No.	l1* mm	l2 mm	EDP No.	l1* mm	l2 mm
110	11.00-11.49	12.00		10.70		9041090110000	147.00	82.60	9041100110000	182.00	117.10
110	11.00-11.49	12.70	1/2	10.70		9041090110050			9041100110050		
115	11.50-11.99	12.00		11.20		9041090115000	151.00	86.10	9041100115000	187.00	122.10
115	11.50-11.99	12.70	1/2	11.20	45.00	9041090115050			9041100115050		
120	12.00-12.49	12.00		11.70		9041090120000	156.00	89.70	9041100120000	194.00	127.20
120	12.00-12.49	12.70	1/2	11.70	45.00	9041090120050			9041100120050		
125	12.50-12.99	14.00		12.20		9041090125000	160.00	93.30	9041100125000	199.00	132.30
125	12.50-12.99	15.875	5/8	12.20	45.00	9041090125050			9041100125050		
130	13.00-13.49	14.00		12.70		9041090130000	164.00	96.90	9041100130000	205.00	137.50
130	13.00-13.49	15.875	5/8	12.70	45.00	9041090130050			9041100130050		
135	13.50-13.99	14.00		13.20		9041090135000	169.00	100.60	9041100135000	211.00	142.50
135	13.50-13.99	15.875	5/8	13.20	45.00	9041090135050			9041100135050		
140	14.00-14.49	14.00		13.70		9041090140000	173.00	104.20	9041100140000	217.00	147.70
140	14.00-14.49	15.875	5/8	13.70	45.00	9041090140050			9041100140050		
145	14.50-14.99	16.00		14.20		9041090145000	180.00	107.80	9041100145000	225.00	152.80
145	14.50-14.99	15.875	5/8	14.20	48.00	9041090145050			9041100145050		
150	15.00-15.49	16.00		14.70		9041090150000	185.00	111.30	9041100150000	232.00	157.80
150	15.00-15.49	15.875	5/8	14.70	48.00	9041090150050			9041100150050		
155	15.50-15.99	16.00		15.20		9041090155000	189.00	114.90	9041100155000	237.00	162.90
155	15.50-15.99	15.875	5/8	15.20	48.00	9041090155050			9041100155050		
160	16.00-16.49	16.00		15.70		9041090160000	193.00	118.90	9041100160000	243.00	168.00
160	16.00-16.49	15.875	5/8	15.70	48.00	9041090160050			9041100160050		
165	16.50-16.99	18.00		16.20		9041090165000	198.00	122.10	9041100165000	249.00	173.10
165	16.50-16.99	19.05	3/4	16.20	48.00	9041090165050			9041100165050		
170	17.00-17.49	18.00		16.70		9041090170000	202.00	125.80	9041100170000	255.00	178.30
170	17.00-17.49	19.05	3/4	16.70	48.00	9041090170050			9041100170050		
175	17.50-17.99	18.00		17.20		9041090175000	206.00	129.40	9041100175000	260.00	183.50
175	17.50-17.99	19.05	3/4	17.20	48.00	9041090175050			9041100175050		
180	18.00-18.49	18.00		17.70		9041090180000	211.00	132.90	9041100180000	267.00	188.40
180	18.00-18.49	19.05	3/4	17.70	48.00	9041090180050			9041100180050		

Holders

For drilling depths over 5xD, we generally recommend spot drilling prior to finish drilling to depth. Drilling depths over 7xD will typically require use of a series 4105 pilot drill with a series 4111 (145°) insert.

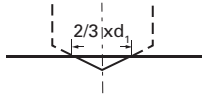

Spot drill for 7xD drilling depths

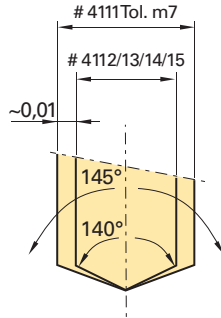

Pilot drill for 10xD drilling depths (see page 10-11)



③

Holder Size	d1 Insert Range mm	d2 mm	d2 in	d3 mm	l3 mm	Series 4109 (7xD)			Series 4110 (10xD)		
						EDP No.	l1* mm	l2 mm	EDP No.	l1* mm	l2 mm
185	18.50-18.99	20.00		18.20	50.00	9041090185000	217.00	136.50	9041100185000	274.00	193.50
185	18.50-18.99	19.05	3/4	18.20	50.00	9041090185050			9041100185050		
190	19.00-19.49	20.00		18.70	50.00	9041090190000	221.00	140.10	9041100190000	280.00	198.70
190	19.00-19.49	19.05	3/4	18.70	50.00	9041090190050			9041100190050		
195	19.50-19.99	20.00		19.20	50.00	9041090195000	226.00	143.70	9041100195000	286.00	203.70
195	19.50-19.99	19.05	3/4	19.20	50.00	9041090195050			9041100195050		
200	20.00-20.49	20.00		19.70	50.00	9041090200000	230.00	147.30	9041100200000	292.00	208.90
200	20.00-20.49	19.05	3/4	19.70	50.00	9041090200050			9041100200050		
205	20.50-20.99	25.00		20.20	56.00	9041090205000	243.00	151.00	9041100205000	306.00	214.00
205	20.50-20.99	25.40	1.0"	20.20	56.00	9041090205050			9041100205050		
210	21.00-21.49	25.00		20.70	56.00	9041090210000	247.00	154.60	9041100210000	312.00	219.10
210	21.00-21.49	25.40	1.0"	20.70	56.00	9041090210050			9041100210050		
215	21.50-21.99	25.00		21.20	56.00	9041090215000	251.00	158.10	9041100215000	317.00	224.20
215	21.50-21.99	25.40	1.0"	21.20	56.00	9041090215050			9041100215050		
220	22.00-22.49	25.00		21.70	56.00	9041090220000	255.00	161.70	9041100220000	323.00	229.30
220	22.00-22.49	25.40	1.0"	21.70	56.00	9041090220050			9041100220050		
225	22.50-22.99	25.00		22.20	56.00	9041090225000	260.00	165.30	9041100225000	329.00	234.40
225	22.50-22.99	25.40	1.0"	22.20	56.00	9041090225050			9041100225050		
230	23.00-23.49	25.00		22.70	56.00	9041090230000	264.00	168.90	9041100230000	335.00	239.50
230	23.00-23.49	25.40	1.0"	22.70	56.00	9041090230050			9041100230050		
235	23.50-23.99	25.00		23.20	56.00	9041090235000	269.00	172.50	9041100235000	341.00	244.60
235	23.50-23.99	25.40	1.0"	23.20	56.00	9041090235050			9041100235050		
240	24.00-24.49	25.00		23.70	56.00	9041090240000	273.00	176.10	9041100240000	347.00	249.70
240	24.00-24.49	25.40	1.0"	23.70	56.00	9041090240050			9041100240050		
245	24.50-24.99	25.00		24.20	56.00	9041090245000	277.00	179.70	9041100245000	352.00	254.80
245	24.50-24.99	25.40	1.0"	24.20	56.00	9041090245050			9041100245050		
250	25.00-25.49	25.00		24.70	56.00	9041090250000	282.00	183.30	9041100250000	359.00	259.90
250	25.00-25.49	25.40	1.0"	24.70	56.00	9041090250050			9041100250050		
255	25.50-25.99	32.00		25.20	60.00	9041090255000	291.00	186.90	9041100255000	369.00	265.00
255	25.50-25.99	31.75		25.20	60.00	9041090255050			9041100255050		

*Items listed in red are non-stocked items, and may take 2 - 6 weeks to receive

HT 800 WP Interchangeable Insert Drills

Drill inserts for pilot drilling - Series 4111 Carbide, nano-A™ coated 145° point angle, m7 tolerance on diameter

The Series 4105 is a pilot and chamfering tool specifically designed for pilot drilling 7xD and especially 10xD deep hole applications. The Series 4111 insert has a 145° point angle which is required for proper application of a pre-drill pilot operation. This pilot drilling insert is also interchangeable with all other HT 800 WP body series.

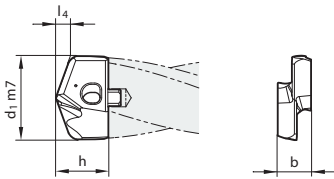

Series 4111

Dia fract.	Dia mm	h mm	b mm	l4 mm	Series 4111 nano-A insert EDP No.	Drill Holder Size
	11.00	6.9	4.5	1.5	9041110110000	110
	11.20	6.9	4.5	1.5	9041110112000	
29/64	11.50	6.9	4.5	1.5	9041110115000	115
	11.51	6.9	4.5	1.5	9041110115100	
	11.70	6.9	4.5	1.6	9041110117000	
	11.80	6.9	4.5	1.6	9041110118000	
15/32	11.91	6.9	4.5	1.6	9041110119100	120
	12.00	7.1	5.0	1.6	9041110120000	
	12.10	7.1	5.0	1.6	9041110121000	
	12.20	7.1	5.0	1.6	9041110122000	
31/64	12.30	7.1	5.0	1.6	9041110123000	
	12.50	7.1	5.0	1.7	9041110125000	
	12.60	7.1	5.0	1.7	9041110126000	
1/2	12.70	7.1	5.0	1.7	9041110127000	
	12.80	7.1	5.0	1.7	9041110128000	
	12.90	7.1	5.0	1.7	9041110129000	
33/64	13.00	7.9	5.5	1.7	9041110130000	130
	13.10	7.9	5.5	1.7	9041110131000	
	13.49	7.9	5.5	1.8	9041110134900	
	13.50	7.9	5.5	1.8	9041110135000	
	13.60	7.9	5.5	1.8	9041110136000	
	13.70	7.9	5.5	1.8	9041110137000	
	13.80	7.9	5.5	1.9	9041110138000	
35/64	13.89	7.9	5.5	1.9	9041110138900	
	14.00	9.1	6.0	1.9	9041110140000	140
9/16	14.10	9.1	6.0	1.9	9041110141000	
	14.29	9.1	6.0	1.9	9041110142900	
	14.40	9.1	6.0	1.9	9041110144000	
37/64	14.50	9.1	6.0	1.9	9041110145000	145
	14.60	9.1	6.0	2.0	9041110146000	
	14.68	9.1	6.0	2.0	9041110146800	
	14.70	9.1	6.0	2.0	9041110147000	
	14.80	9.1	6.0	2.0	9041110148000	
19/32	15.00	9.1	6.0	2.0	9041110150000	150
	15.08	9.1	6.0	2.0	9041110150800	
	15.10	9.1	6.0	2.0	9041110151000	
	15.20	9.1	6.0	2.0	9041110152000	
	15.30	9.1	6.0	2.1	9041110153000	
39/64	15.48	9.1	6.0	2.1	9041110154800	155
	15.50	9.1	6.0	2.1	9041110155000	
	15.60	9.1	6.0	2.1	9041110156000	
	15.70	9.1	6.0	2.1	9041110157000	
	15.80	9.1	6.0	2.1	9041110158000	
5/8	15.87	9.1	6.0	2.1	9041110158700	160
	16.00	10.2	7.0	2.1	9041110160000	
41/64	16.27	10.2	7.0	2.2	9041110162700	165
	16.50	10.2	7.0	2.2	9041110165000	
21/32	16.67	10.2	7.0	2.2	9041110166700	

Dia fract.	Dia mm	h mm	b mm	l4 mm	Series 4111 nano-A insert EDP No.	Drill Holder Size
	17.00	10.2	7.0	2.3	9041110170000	170
43/64	17.07	10.2	7.0	2.3	9041110170700	
11/16	17.46	10.2	7.0	2.3	9041110174600	
	17.50	10.2	7.0	2.3	9041110175000	175
	17.60	10.2	7.0	2.3	9041110176000	
45/64	17.86	10.2	7.0	2.4	9041110178600	180
	18.00	11.7	8.0	2.4	9041110180000	
23/32	18.26	11.7	8.0	2.4	9041110182600	185
	18.50	11.7	8.0	2.5	9041110185000	
47/64	18.65	11.7	8.0	2.5	9041110186500	190
	19.00	11.7	8.0	2.5	9041110190000	
3/4	19.05	11.7	8.0	2.5	9041110190500	195
	19.45	11.7	8.0	2.6	9041110194500	
	19.50	11.7	8.0	2.6	9041110195000	200
	19.60	11.7	8.0	2.6	9041110196000	
25/32	19.84	11.7	8.0	2.7	9041110198400	
	20.00	12.9	9.0	2.7	9041110200000	205
51/64	20.24	12.9	9.0	2.7	9041110202400	
	20.50	12.9	9.0	2.7	9041110205000	210
13/16	20.64	12.9	9.0	2.8	9041110206400	
	21.00	12.9	9.0	2.8	9041110210000	
53/64	21.03	12.9	9.0	2.8	9041110210300	215
	21.10	12.9	9.0	2.8	9041110211000	
	21.43	12.9	9.0	2.9	9041110214300	
27/32	21.50	13.9	9.0	3.9	9041110215000	220
	21.83	13.9	9.0	4.0	9041110218300	
7/8	22.00	14.3	10.0	3.0	9041110220000	225
	22.22	14.3	10.0	3.0	9041110222200	
57/64	22.50	14.3	10.0	3.0	9041110225000	230
	22.62	14.3	10.0	3.0	9041110226200	
	23.00	14.3	10.0	3.1	9041110230000	235
29/32	23.02	14.3	10.0	3.1	9041110230200	
	23.42	14.3	10.0	3.1	9041110234200	
15/16	23.50	14.3	10.0	3.1	9041110235000	240
	23.81	14.3	10.0	3.2	9041110238100	
	24.00	14.7	11.0	3.2	9041110240000	245
61/64	24.10	14.7	11.0	3.2	9041110241000	
	24.21	14.7	11.0	3.2	9041110242100	
31/32	24.50	14.7	11.0	3.3	9041110245000	250
	24.61	14.7	11.0	3.3	9041110246100	
1	25.00	14.7	11.0	3.4	9041110250000	255
	25.40	14.7	11.0	3.4	9041110254000	
	25.50	14.7	11.0	3.4	9041110255000	260
1 1/32	26.00	19.40	12.00	4.10	9041110260000	
	26.19	19.40	12.00	4.10	9041110261900	
1 3/64	26.50	19.40	12.00	4.10	9041110265000	265
	26.59	19.40	12.00	4.20	9041110265900	
	27.00	19.40	12.00	4.20	9041110270000	270

1 x D for Pilot Drilling and Countersinking

Holders for pilot drilling - Series 4105 HSS, coolant fed, nickel treated

Twist Drills

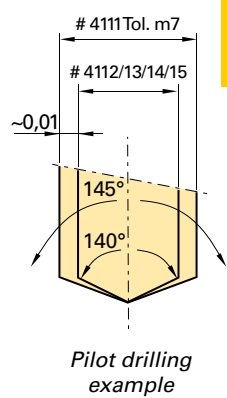
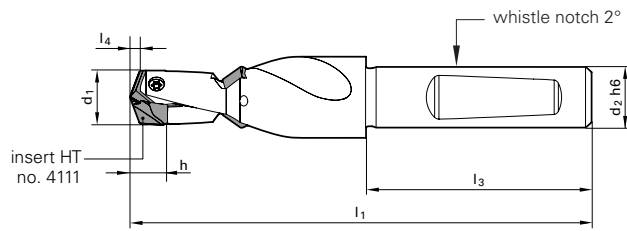
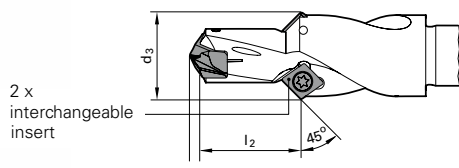

Holder Size	EDP No.	d1 Insert Range mm	d2 mm	d2 in	d3 mm	Series 4105 Holder (1xD w/countersink)		
						l1 mm	l2 mm	l3 mm
110	9041050110000	11.00-11.99	12.00		17.00	81.00	14.80	45.00
	9041050110050	11.00-11.99	12.70	1/2	17.00			
120	9041050120000	12.00-12.99	12.00		18.00	84.00	15.80	45.00
	9041050120050	12.00-12.99	12.70	1/2	18.00			
130	9041050130000	13.00-13.99	14.00		18.00	86.00	16.30	45.00
	9041050130050	13.00-13.99	15.875	5/8	18.00			
140	9041050140000	14.00-15.99	16.00		18.00	93.00	17.40	48.00
	9041050140050	14.00-15.99	15.875	5/8	18.00			
160	9041050160000	16.00-17.99	18.00		20.00	99.00	19.40	48.00
	9041050160050	16.00-17.99	19.05	3/4	20.00			
180	9041050180000	18.00-19.99	20.00		22.00	106.00	21.40	50.00
	9041050180050	18.00-19.99	19.05	3/4	22.00			
200	9041050200000	20.00-21.99	25.00		24.00	117.00	23.40	56.00
	9041050200050	20.00-21.99	25.40	1.0"	24.00			
220	9041050220000	22.00-23.99	25.00		26.00	122.00	25.40	56.00
	9041050220050	22.00-23.99	25.40	1.0"	26.00			
240	9041050240000	24.00-25.99	25.00		28.00	128.00	27.40	56.00
	9041050240050	24.00-25.99	25.40	1.0"	28.00			

Countersink inserts for pilot and countersink holes



Series 7645 for steels



Series 7632 for cast iron



Series 7635 for aluminum

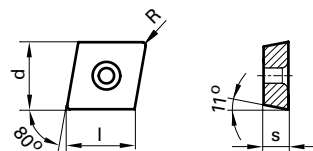

Type	d mm	s mm	R mm	l mm	Series 7645 TIN coated	Series 7632 TiAlN coated	Series 7635 Bright finish	Drill Holder Size
					EDP No.	EDP No.	EDP No.	
CPGT050204R	5.56	2.38	0.4	5.64	9076450520400		9076350520400	110-140
CPGT060204R	6.35	2.38	0.4	6.45	9076450620400		9076350620400	160-280
CPGW050204	5.56	2.38	0.4	5.60		9076320520400		110-140
CPGW060204	6.35	2.38	0.4	6.40		9076320620400		160-280

*Items listed in red are non-stocked items, and may take 2 - 6 weeks to receive

Inserts

Large Diameter

Carbide, self-centering 140° SF point, RH cut

Cut Dia. = h7 tolerance range

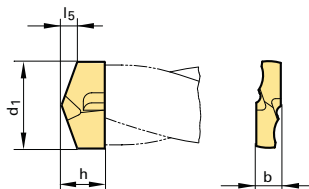

Speeds & Feeds
information pg 468-469

② Application Materials:

Series 2747



Aluminum & Alloys

Series 1047



General Steels/Brass



Universal Steels

Series 2485



General Steels/Brass



Universal Steels



Stainless Steels



Hardened Materials



Cast Iron



Ti & Ni Alloys

- ① Choose your diameter (metric or inch)
- ② Choose the appropriate insert for your workpiece material
- ③ Note the holder size for that insert diameter; select a holder (3xD, 5xD or 7xD) from the following page.

①								③
Dia	Dia	h	b	l5	Series 2747	Series 1047	Series 2485	Holder Size
fract.	mm	mm	mm	mm	(bright)	(TiN)	(FIREX®)	
41/64	16.000	8.00	4.50	2.9	9027470160000	9010470160000	9024850160000	0.1
	16.270	8.00	4.50	3.0	9027470162700	9010470162700	9024850162700	
	16.500	8.00	4.50	3.0	9027470165000	9010470165000	9024850165000	
21/32	16.670	8.00	4.50	3.0	9027470166700	9010470166700	9024850166700	0.1
	17.000	8.00	4.50	3.1	9027470170000	9010470170000	9024850170000	
43/64	17.070	8.00	4.50	3.1	9027470170700	9010470170700	9024850170700	0.2
	17.460	8.00	4.50	3.1	9027470174600	9010470174600	9024850174600	
11/16	17.500	8.00	5.00	3.2	9027470175000	9010470175000	9024850175000	0.2
	17.860	8.00	5.00	3.3	9027470178600	9010470178600	9024850178600	
	18.000	8.00	5.00	3.3	9027470180000	9010470180000	9024850180000	
23/32	18.260	8.00	5.00	3.3	9027470182600	9010470182600	9024850182600	1.1
	18.500	8.00	5.00	3.4	9027470185000	9010470185000	9024850185000	
47/64	18.650	8.00	5.00	3.4	9027470186500	9010470186500	9024850186500	1.1
	19.000	8.00	5.00	3.5	9027470190000	9010470190000	9024850190000	
	19.050	8.00	5.00	3.5	9027470190500	9010470190500	9024850190500	
3/4	19.250	8.00	5.00	3.5	9027470192500	9010470192500	9024850192500	1.2
	19.450	8.00	5.00	3.5	9027470194500	9010470194500	9024850194500	
49/64	19.500	8.00	5.00	3.5	9027470195000	9010470195000	9024850195000	1.2
	19.840	8.00	5.00	3.6	9027470198400	9010470198400	9024850198400	
	20.000	8.00	5.00	3.6	9027470200000	9010470200000	9024850200000	
51/64	20.240	8.80	5.50	3.6	9027470202400	9010470202400	9024850202400	2.1
	20.500	8.80	5.50	3.7	9027470205000	9010470205000	9024850205000	
13/16	20.640	8.80	5.50	3.8	9027470206400	9010470206400	9024850206400	2.1
	21.000	8.80	5.50	3.8	9027470210000	9010470210000	9024850210000	
	21.030	8.80	5.50	3.8	9027470210300	9010470210300	9024850210300	
53/64	21.430	8.80	5.50	3.9	9027470214300	9010470214300	9024850214300	2.2
	21.500	8.80	5.50	3.9	9027470215000	9010470215000	9024850215000	
55/64	21.830	8.80	5.50	4.0	9027470218300	9010470218300	9024850218300	2.2
	22.000	8.80	5.50	4.0	9027470220000	9010470220000	9024850220000	
	22.220	8.80	5.50	4.0	9027470222200	9010470222200	9024850222200	
7/8	22.500	8.80	5.50	4.1	9027470225000	9010470225000	9024850225000	

Inserts

Large Diameter

Carbide, self-centering 140° SF point, RH cut

Cut Dia. = h7 tolerance range

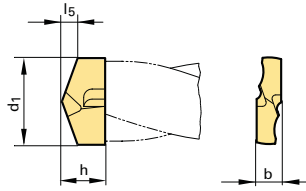

Speeds & Feeds
information pg 468-469



Dia fract.	Dia mm	h mm	b mm	l5 mm	Series	Series	Series	Holder Size		
					2747 (bright)	1047 (TiN)	2485 (FIREX®)			
57/64	22.620	10.00	6.30	4.1	9027470226200	9010470226200	9024850226200	3.1		
	23.000				9027470230000	9010470230000	9024850230000			
29/32	23.020	10.00	6.30	4.2	9027470230200	9010470230200	9024850230200			
59/64	23.420	10.00	6.30	4.3	9027470234200	9010470234200	9024850234200			
	23.500				9027470235000	9010470235000	9024850235000			
15/16	23.810	10.00	6.30	4.3	9027470238100	9010470238100	9024850238100			
	24.000				9027470240000	9010470240000	9024850240000			
61/64	24.210	10.00	6.30	4.4	9027470242100	9010470242100	9024850242100		3.2	
	24.500				9027470245000	9010470245000	9024850245000			
31/32	24.610	10.00	6.30	4.5	9027470246100	9010470246100	9024850246100			
63/64	25.000	10.00	6.30	4.5	9027470250000	9010470250000	9024850250000			
1	25.400	10.00	6.30	4.6	9027470254000	9010470254000	9024850254000			
	25.500				9027470255000	9010470255000	9024850255000			
26.000	11.60	7.30	4.7	4.7	9027470260000	9010470260000	9024850260000	4.1		
					26.500	9027470265000	9010470265000			9024850265000
					27.000	9027470270000	9010470270000			9024850270000
					27.500	9027470275000	9010470275000			9024850275000
28.000	11.60	7.30	5.1	5.1	9027470280000	9010470280000	9024850280000	4.2		
					28.500	9027470285000	9010470285000		9024850285000	
					29.000	9027470290000	9010470290000		9024850290000	
					29.500	9027470295000	9010470295000		9024850295000	
30.000	13.60	8.50	5.5	5.5	9027470300000	9010470300000	9024850300000	5.1		
					30.500	9027470305000	9010470305000		9024850305000	
					31.000	9027470310000	9010470310000		9024850310000	
					31.500	9027470315000	9010470315000		9024850315000	
32.000	13.60	8.50	5.8	5.8	9027470320000	9010470320000	9024850320000	5.2		
					32.500	9027470325000	9010470325000		9024850325000	
					33.000	9027470330000	9010470330000		9024850330000	
					33.500	9027470335000	9010470335000		9024850335000	
34.000	13.60	8.50	6.2	6.2	9027470340000	9010470340000	9024850340000	6.1		
					34.500	9027470345000	9010470345000		9024850345000	
					35.000	9027470350000	9010470350000		9024850350000	
					36.000	9027470360000	9010470360000		9024850360000	
37.000	16.00	10.00	6.7	6.7	9027470370000	9010470370000	9024850370000	6.2		
					37.500	9027470375000	9010470375000		9024850375000	
					38.000	9027470380000	9010470380000		9024850380000	
					39.000	9027470390000	9010470390000		9024850390000	
40.000	16.00	10.00	7.3	7.3	9027470400000	9010470400000	9024850400000			
					40.500	9027470405000	9010470405000	9024850405000		

*Items listed in red are non-stocked items, and may take 2 - 6 weeks to receive

RT 800 WP

Indexable Insert Drills

Bodies



Coolant Through

Reinforced Straight Shank w/
Whistle NotchSpeeds & Feeds
information pg 468-474Large Diameter
HSS, full-helix flute, nickel treated

Shank Dia. = h6 tolerance range

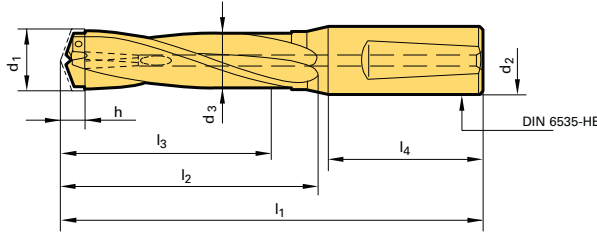

③

Holder Size	Insert Range mm	d1 mm	d2 mm	d2 in	d3 mm	l4 mm	Series 5242 (3xD)				Series 5243 (5xD)				Series 5248 (7xD)			
							l1 mm	l2 mm	l3 mm	EDP No.	l1 mm	l2 mm	l3 mm	EDP No.	l1 mm	l2 mm	l3 mm	EDP No.
0.1	16.00-17.00	15.70	20.00		15.7	50	130	76	54	9052420170000	166	112	90	9052430170000	202	148	126	9052480170000
	16.00-17.00	15.70		3/4	15.7	50				9052420170050				9052430170050				9052480170050
0.2	17.00-17.86	16.70	20.00		16.7	50	130	76	54	9052420179900	166	112	90	9052430179900	202	148	126	9052480179900
	17.00-17.86	16.70		3/4	16.7	50				9052420179950				9052430179950				9052480179950
1.1	18.00-19.05	17.70	20.00		17.7	50	138	84	60	9052420190000	178	124	100	9052430190000	218	164	140	9052480190000
	18.00-19.05	17.70		3/4	17.7	50				9052420190050				9052430190050				9052480190050
1.2	19.00-20.00	18.70	20.00		18.7	50	138	84	60	9052420200000	178	124	100	9052430200000	218	164	140	9052480200000
	19.00-20.00	18.70		3/4	18.7	50				9052420200050				9052430200050				9052480200050
2.1	20.24-21.03	19.70	25.00		19.7	56	153	93	66	9052420210000	197	137	110	9052430210000	241	181	154	9052480210000
	20.24-21.03	19.70		1.00	19.7	56				9052420210050				9052430210050				9052480210050
2.2	21.00-22.50	20.70	25.00		20.7	56	153	93	66	9052420225000	197	137	110	9052430225000	241	181	154	9052480225000
	21.00-22.50	20.70		1.00	20.7	56				9052420225050				9052430225050				9052480225050
3.1	22.62-24.00	22.20	25.00		22.2	56	161	101	72	9052420240000	209	149	120	9052430240000	257	197	168	9052480240000
	22.62-24.00	22.20		1.00	22.2	56				9052420240050				9052430240050				9052480240050
3.2	24.00-25.50	23.70	25.00		23.7	56	170	110	78	9052420255000	222	162	130	9052430255000	274	214	182	9052480255000
	24.00-25.50	23.70		1.00	23.7	56				9052420255050				9052430255050				9052480255050
4.1	26.00-27.50	25.20	32.00		25.2	60	182	118	84	9052420275000	238	174	140	9052430275000	294	230	196	9052480275000
	26.00-27.50	25.20		1 1/4	25.2	60				9052420275050				9052430275050				9052480275050
4.2	27.50-29.50	27.20	32.00		27.2	60	190	126	90	9052420295000	250	186	150	9052430295000	310	246	210	9052480295000
	27.50-29.50	27.20		1 1/4	27.2	60				9052420295050				9052430295050				9052480295050
5.1	30.00-32.00	29.20	32.00		29.2	60	198	134	96	9052420320000	262	198	160	9052430320000	326	262	224	9052480320000
	30.00-32.00	29.20		1 1/4	29.2	60				9052420320050				9052430320050				9052480320050
5.2	32.00-34.50	31.70	32.00		31.7	60	206	142	102	9052420345000	274	210	170	9052430345000	342	278	238	9052480345000
	32.00-34.50	31.70		1 1/4	31.7	60				9052420345050				9052430345050				9052480345050
6.1	35.00-37.50	34.00	32.00		34.0	60	218	154	114	9052420375000	292	228	190	9052430375000	366	302	266	9052480375000
	35.00-37.50	34.00		1 1/4	34.0	60				9052420375050				9052430375050				9052480375050
6.2	37.50-40.50	37.00	32.00		37.0	60	231	167	120	9052420405000	311	247	200	9052430405000	391	327	280	9052480405000
	37.50-40.50	37.00		1 1/4	37.0	60				9052420405050				9052430405050				9052480405050

Clamping screws for HT 800 inserts

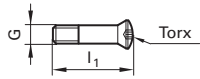

Series 4071

For holder size	Size	OAL	with Torx	EDP No.
110/115	M2.2	9.50	T7	9040710022000
120/125	M2.2	10.50	T7	9040710022010
130/135	M2.5	11.40	T8	9040710025000
140/145	M3	12.10	T9	9040710030000
150/155	M3	13.10	T9	9040710030010
160 - 175	M3.5	14.25	T10	9040710035000
180 - 195	M4	16.00	T15	9040710040000
200 - 215	M4.5	18.00	T15	9040710045000
220 - 235	M5	19.75	T20	9040710050000
240 - 255	M5	21.75	T20	9040710050010
260 - 295	M5	23.40	T20	9040710050030
300 - 315	M6	27.00	T25	9040710060000
320 - 350	M6	28.50	T25	9040710060010
360 - 390	M6	32.50	T25	9040710060020

Screw driver



Series 1612

For holder size	for Torx	EDP No.
Pilot holder 110 - 140	T6	9016120060000
Pilot holder 160 - 280	T7	9016120070000
110 - 125	T7	9016120070010
130/135	T8	9016120080010
140 - 155	T9	9016120090010
160 - 175	T10	9016120100010
Pilot holder 300 - 360	T15	9016120150000
180 - 215	T15	9016120150010
220-295	T20	9016120200010
300 - 390	T25	9016120250000

Clamping screws for chamfering inserts

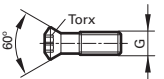







Series 6128

For holder size	Size	OAL	with Torx	EDP No.
110 - 140	M2.0	5.5	T6	9061280020000
160 - 240	M2.5	5.3	T7	9061280025000
300 - 360	M4.0	9.5	T15	9061280040000

Torx Bits





Series 4917

for Torx	Drive	l1 mm	EDP No.
T7	1/4" 	25	9049170070000
T8	1/4" 	25	9049170080000
T9	1/4" 	25	9049170090000
T10	1/4" 	25	9049170100000
T15	1/4" 	25	9049170150000
T20	1/4" 	25	9049170200000
T25	1/4" 	25	9049170250000

Torx driver



Series 4915

Type	Drive	l1 mm	Tightening torque (Ncm)	EDP No.
A	1/4" 	160.00	0.8 - 2	9049150020000
A	1/4" 	160.00	2 - 8	9049150080000
A	1/4" 	200.00	5 - 14	9049150140000

Torque values for clamping screws

Diameter range	11.0 - 12.99	13.0 - 13.99	14.0 - 15.99	16.0 - 17.99	18.0 - 19.99	20.0 - 21.99	22.0 - 25.99
Thread	M2.2	M2.5	M3	M3.5	M4	M4.5	M5
Torx size	T7	T8	T9	T10	T15	T15	T20
Tightening torque (Ncm)	80	100	170	270	400	580	810

*Items listed in red are non-stocked items, and may take 2 - 6 weeks to receive

7xD

Series 4044

Application Materials:

-  General Steels/Brass
-  Universal Steels
-  Stainless Steels
-  Cast Iron

N

nano-FIREX® coated

RT 100 X High Penetration

Carbide, RT 100 X high penetration, 7xD, self-centering
140° U point, double margin, reinforced straight shank, RH helix

Cut Dia. = m7 tolerance range, Shank Dia. = h6



Coolant Through

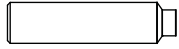

Reinforced Straight Shank

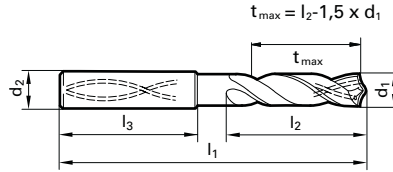

Speeds & Feeds
information pg 479

Diameter (d1)		Wire / letter	d2	l1	l2	EDP #	
Dec. inch	Fract. inch						
0.1181			3.00	6.00	70.00	30.00	9040440030000
0.1220			3.10	6.00	70.00	30.00	9040440031000
0.1248	1/8		3.17	6.00	70.00	30.00	9040440031700
0.1260			3.20	6.00	70.00	30.00	9040440032000
0.1280			3.25	6.00	70.00	30.00	9040440032500
0.1299			3.30	6.00	70.00	30.00	9040440033000
0.1339			3.40	6.00	75.00	37.50	9040440034000
0.1378			3.50	6.00	75.00	37.50	9040440035000
0.1406	9/64	28	3.57	6.00	75.00	37.50	9040440035700
0.1417			3.60	6.00	75.00	37.50	9040440036000
0.1457			3.70	6.00	75.00	37.50	9040440037000
0.1496		25	3.80	6.00	75.00	37.50	9040440038000
0.1535			3.90	6.00	75.00	37.50	9040440039000
0.1563	5/32		3.97	6.00	75.00	37.50	9040440039700
0.1575			4.00	6.00	75.00	37.50	9040440040000
0.1591		21	4.04	6.00	75.00	37.50	9040440040400
0.1614			4.10	6.00	75.00	37.50	9040440041000
0.1654			4.20	6.00	75.00	37.50	9040440042000
0.1693			4.30	6.00	85.00	45.00	9040440043000
0.1720	11/64		4.37	6.00	85.00	45.00	9040440043700
0.1732			4.40	6.00	85.00	45.00	9040440044000
0.1772			4.50	6.00	85.00	45.00	9040440045000
0.1811			4.60	6.00	85.00	45.00	9040440046000
0.1830			4.65	6.00	85.00	45.00	9040440046500
0.1850			4.70	6.00	85.00	45.00	9040440047000
0.1874	3/16		4.76	6.00	90.00	50.00	9040440047600
0.1890			4.80	6.00	90.00	50.00	9040440048000
0.1929			4.90	6.00	90.00	50.00	9040440049000
0.1969			5.00	6.00	90.00	50.00	9040440050000
0.2008			5.10	6.00	90.00	50.00	9040440051000
0.2012		7	5.11	6.00	90.00	50.00	9040440051100
0.2031	13/64		5.16	6.00	90.00	50.00	9040440051600
0.2047			5.20	6.00	90.00	50.00	9040440052000
0.2087			5.30	6.00	90.00	50.00	9040440053000
0.2126			5.40	6.00	90.00	50.00	9040440054000
0.2130		3	5.41	6.00	90.00	50.00	9040440054100
0.2165			5.50	6.00	97.00	57.00	9040440055000
0.2189	7/32		5.56	6.00	97.00	57.00	9040440055600
0.2205			5.60	6.00	97.00	57.00	9040440056000
0.2244			5.70	6.00	97.00	57.00	9040440057000
0.2283			5.80	6.00	97.00	57.00	9040440058000
0.2323			5.90	6.00	97.00	57.00	9040440059000
0.2343	15/64		5.95	6.00	97.00	57.00	9040440059500
0.2362			6.00	6.00	97.00	57.00	9040440060000
0.2402			6.10	6.00	97.00	57.00	9040440061000
0.2441			6.20	8.00	106.00	66.00	9040440062000
0.2480			6.30	8.00	106.00	66.00	9040440063000
0.2500	1/4	E	6.35	8.00	106.00	66.00	9040440063500
0.2520			6.40	8.00	106.00	66.00	9040440064000
0.2559			6.50	8.00	106.00	66.00	9040440065000
0.2571		F	6.53	8.00	106.00	66.00	9040440065300
0.2598			6.60	8.00	106.00	66.00	9040440066000
0.2638			6.70	8.00	106.00	66.00	9040440067000
0.2657	17/64	H	6.75	8.00	106.00	66.00	9040440067500

Diameter (d1)		Wire / letter	d2	l1	l2	EDP #	
Dec. inch	Fract. inch						
0.2677			6.80	8.00	106.00	66.00	9040440068000
0.2717		I	6.90	8.00	116.00	76.00	9040440069000
0.2756			7.00	8.00	116.00	76.00	9040440070000
0.2795			7.10	8.00	116.00	76.00	9040440071000
0.2811	9/32	K	7.14	8.00	116.00	76.00	9040440071400
0.2835			7.20	8.00	116.00	76.00	9040440072000
0.2874			7.30	8.00	116.00	76.00	9040440073000
0.2913			7.40	8.00	116.00	76.00	9040440074000
0.2953			7.50	8.00	116.00	76.00	9040440075000
0.2969	19/64		7.54	8.00	116.00	76.00	9040440075400
0.2992			7.60	8.00	116.00	76.00	9040440076000
0.3031			7.70	8.00	116.00	76.00	9040440077000
0.3071			7.80	8.00	116.00	76.00	9040440078000
0.3110			7.90	8.00	116.00	76.00	9040440079000
0.3126	5/16		7.94	8.00	116.00	76.00	9040440079400
0.3150			8.00	8.00	116.00	76.00	9040440080000
0.3189			8.10	10.00	131.00	87.00	9040440081000
0.3228		P	8.20	10.00	131.00	87.00	9040440082000
0.3268			8.30	10.00	131.00	87.00	9040440083000
0.3280	21/64		8.33	10.00	131.00	87.00	9040440083300
0.3307			8.40	10.00	131.00	87.00	9040440084000
0.3346			8.50	10.00	131.00	87.00	9040440085000
0.3386			8.60	10.00	131.00	87.00	9040440086000
0.3425			8.70	10.00	131.00	87.00	9040440087000
0.3437	11/32		8.73	10.00	131.00	87.00	9040440087300
0.3465			8.80	10.00	131.00	87.00	9040440088000
0.3504			8.90	10.00	131.00	87.00	9040440089000
0.3543			9.00	10.00	131.00	87.00	9040440090000
0.3583			9.10	10.00	139.00	95.00	9040440091000
0.3594	23/64		9.13	10.00	139.00	95.00	9040440091300
0.3622			9.20	10.00	139.00	95.00	9040440092000
0.3642			9.25	10.00	139.00	95.00	9040440092500
0.3661			9.30	10.00	139.00	95.00	9040440093000
0.3677		U	9.34	10.00	139.00	95.00	9040440093400
0.3701			9.40	10.00	139.00	95.00	9040440094000
0.3740			9.50	10.00	139.00	95.00	9040440095000
0.3748	3/8		9.52	10.00	139.00	95.00	9040440095200
0.3780			9.60	10.00	139.00	95.00	9040440096000
0.3819			9.70	10.00	139.00	95.00	9040440097000
0.3858		W	9.80	10.00	139.00	95.00	9040440098000
0.3898			9.90	10.00	139.00	95.00	9040440099000
0.3906	25/64		9.92	10.00	139.00	95.00	9040440099200
0.3937			10.00	10.00	139.00	95.00	9040440100000
0.3976			10.10	12.00	155.00	106.00	9040440101000
0.3937			10.20	12.00	155.00	106.00	9040440102000
0.4055			10.30	12.00	155.00	106.00	9040440103000
0.4063	13/32		10.32	12.00	155.00	106.00	9040440103200
0.4094			10.40	12.00	155.00	106.00	9040440104000
0.4134			10.50	12.00	155.00	106.00	9040440105000
0.4173			10.60	12.00	155.00	106.00	9040440106000
0.4213			10.70	12.00	155.00	106.00	9040440107000
0.4220	27/64		10.72	12.00	155.00	106.00	9040440107200
0.4252			10.80	12.00	155.00	106.00	9040440108000
0.4291			10.90	12.00	155.00	106.00	9040440109000

Series 4044

Speeds & Feeds information pg 479

Twist Drills

Diameter (d1)							
Dec. inch	Fract. inch	Wire / letter	mm	d2 mm	l1 mm	l2 mm	EDP #
0.4331			11.000	12.000	155.00	106.00	9040440110000
0.4370			11.100	12.000	155.00	106.00	9040440111000
0.4374	7/16		11.110	12.000	163.00	114.00	9040440111100
0.4409			11.200	12.000	163.00	114.00	9040440112000
0.4449			11.300	12.000	155.00	106.00	9040440113000
0.4488			11.400	12.000	155.00	106.00	9040440114000
0.4528			11.500	12.000	163.00	114.00	9040440115000
0.4531	29/64		11.510	12.000	155.00	106.00	9040440115100
0.4567			11.600	12.000	155.00	106.00	9040440116000
0.4606			11.700	12.000	155.00	106.00	9040440117000
0.4646			11.800	12.000	163.00	114.00	9040440118000
0.4685			11.900	12.000	163.00	114.00	9040440119000
0.4689	15/32		11.910	12.000	163.00	114.00	9040440119100
0.4724			12.000	12.000	163.00	114.00	9040440120000
0.4764			12.100	14.000	182.00	133.00	9040440121000
0.4803			12.200	14.000	182.00	133.00	9040440122000
0.4843	31/64		12.300	14.000	182.00	133.00	9040440123000
0.4921			12.500	14.000	182.00	133.00	9040440125000
0.5000	1/2		12.700	14.000	182.00	133.00	9040440127000
0.5118			13.000	14.000	182.00	133.00	9040440130000
0.5157			13.100	14.000	182.00	133.00	9040440131000
0.5311	17/32		13.490	14.000	182.00	133.00	9040440134900
0.5315			13.500	14.000	182.00	133.00	9040440135000
0.5469	35/64		13.890	14.000	182.00	133.00	9040440138900
0.5512			14.000	14.000	182.00	133.00	9040440140000
0.5551			14.100	16.000	204.00	152.00	9040440141000

Diameter (d1)							
Dec. inch	Fract. inch	Wire / letter	mm	d2 mm	l1 mm	l2 mm	EDP #
0.5591			14.200	16.000	204.00	152.00	9040440142000
0.5626	9/16		14.290	16.000	204.00	152.00	9040440142900
0.5709			14.500	16.000	204.00	152.00	9040440145000
0.5906			15.000	16.000	204.00	152.00	9040440150000
0.5945			15.100	16.000	204.00	152.00	9040440151000
0.6094	39/64		15.480	16.000	204.00	152.00	9040440154800
0.6102			15.500	16.000	204.00	152.00	9040440155000
0.6248	5/8		15.870	16.000	204.00	152.00	9040440158700
0.6299			16.000	16.000	204.00	152.00	9040440160000
0.6496			16.500	18.000	223.00	171.00	9040440165000
0.6654			16.900	18.000	223.00	171.00	9040440169000
0.6693			17.000	18.000	223.00	171.00	9040440170000
0.6890			17.500	18.000	223.00	171.00	9040440175000
0.7087			18.000	18.000	223.00	171.00	9040440180000
0.7283			18.500	20.000	244.00	190.00	9040440185000
0.7441			18.900	20.000	244.00	190.00	9040440189000
0.7480			19.000	20.000	244.00	190.00	9040440190000
0.7500	3/4		19.050	20.000	244.00	190.00	9040440190500
0.7677			19.500	20.000	244.00	190.00	9040440195000
0.7874			20.000	20.000	244.00	190.00	9040440200000

Alternative Drill Series:
 #5512 Carbide, RT100, 7xD, 140 U pt, FIREX®

*Items listed in red are non-stocked items, and may take 2 - 6 weeks to receive





EB 100

Single flute gun drill

Carbide flute, Type G point, standard driver, RH cut

Cut Dia. = h5 tolerance range, Shank Dia. = h6

Application Materials:

-  General Steels/Brass
-  Universal Steels
-  Cast Iron
-  Aluminum & Alloys



Bright Finish

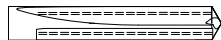

Coolant Through



Reinforced Straight Shank

Speeds & Feeds
information pg 480

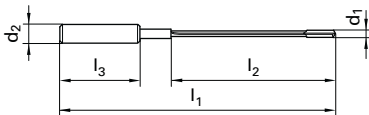

Series 5024 45mm flute length

Diameter (d1)			mm	d2 mm	l1 mm	l2 mm	EDP #
Dec. inch	Fract. inch	Wire / letter					
0.0472			1.200	4.000	90.00	45.00	9050240012000
0.0591			1.500	4.000	90.00	45.00	9050240015000
0.0630			1.600	4.000	90.00	45.00	9050240016000
0.0787			2.000	4.000	90.00	45.00	9050240020000
0.0984			2.500	10.000	100.00	45.00	9050240025000
0.1063			2.700	10.000	100.00	45.00	9050240027000
0.1181			3.000	10.000	100.00	45.00	9050240030000
0.1260			3.200	10.000	100.00	45.00	9050240032000

Series 5020 80mm flute length

Diameter (d1)			mm	d2 mm	l1 mm	l2 mm	EDP #
Dec. inch	Fract. inch	Wire / letter					
0.0472			1.200	4.000	125.00	80.00	9050200012000
0.0591			1.500	4.000	125.00	80.00	9050200015000
0.0630			1.600	4.000	125.00	80.00	9050200016000
0.0787			2.000	4.000	125.00	80.00	9050200020000
0.0984			2.500	10.000	135.00	80.00	9050200025000
0.1063			2.700	10.000	135.00	80.00	9050200027000
0.1181			3.000	10.000	135.00	80.00	9050200030000
0.1260			3.200	10.000	135.00	80.00	9050200032000
0.1378			3.500	10.000	135.00	80.00	9050200035000
0.1575			4.000	10.000	135.00	80.00	9050200040000
0.1654			4.200	10.000	135.00	80.00	9050200042000
0.1772		16	4.500	10.000	135.00	80.00	9050200045000
0.1969			5.000	10.000	135.00	80.00	9050200050000

Series 5026 120mm flute length

Diameter (d1)			mm	d2 mm	l1 mm	l2 mm	EDP #
Dec. inch	Fract. inch	Wire / letter					
0.0591			1.500	4.000	165.00	120.00	9050260015000
0.0630			1.600	4.000	165.00	120.00	9050260016000
0.0787			2.000	4.000	165.00	120.00	9050260020000
0.0984			2.500	10.000	175.00	120.00	9050260025000
0.1063			2.700	10.000	175.00	120.00	9050260027000
0.1181			3.000	10.000	175.00	120.00	9050260030000
0.1260			3.200	10.000	175.00	120.00	9050260032000
0.1378			3.500	10.000	175.00	120.00	9050260035000
0.1575			4.000	10.000	175.00	120.00	9050260040000
0.1654			4.200	10.000	175.00	120.00	9050260042000
0.1772		16	4.500	10.000	175.00	120.00	9050260045000
0.1969			5.000	10.000	175.00	120.00	9050260050000

Series 5021 160mm flute length

Diameter (d1)			mm	d2 mm	l1 mm	l2 mm	EDP #
Dec. inch	Fract. inch	Wire / letter					
0.0591			1.500	4.000	205.00	160.00	9050210015000
0.0630			1.600	4.000	205.00	160.00	9050210016000
0.0787			2.000	4.000	205.00	160.00	9050210020000
0.0984			2.500	10.000	215.00	160.00	9050210025000
0.1063			2.700	10.000	215.00	160.00	9050210027000
0.1181			3.000	10.000	215.00	160.00	9050210030000
0.1260			3.200	10.000	215.00	160.00	9050210032000
0.1378			3.500	10.000	215.00	160.00	9050210035000
0.1575			4.000	10.000	215.00	160.00	9050210040000
0.1654			4.200	10.000	215.00	160.00	9050210042000
0.1772		16	4.500	10.000	215.00	160.00	9050210045000
0.1969			5.000	10.000	215.00	160.00	9050210050000
0.2362			6.000	16.000	225.00	160.00	9050210060000
0.3150			8.000	16.000	225.00	160.00	9050210080000

EB 100 Standard point grinds

(special point grinds
on request)

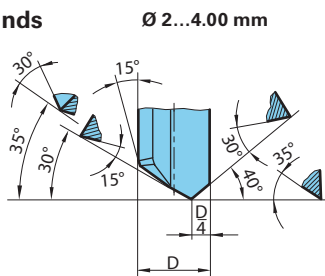

Ø 2...4.00 mm

Ø > 4.01...20 mm

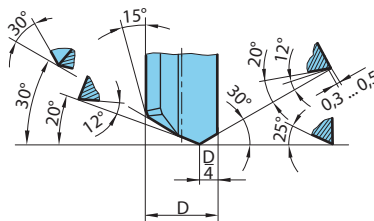

EB 100 Back taper ratio

(dimensions
in mm)

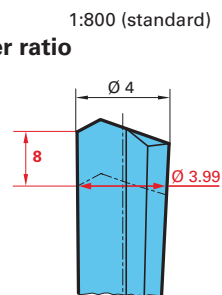

3xD



FIREX® coated



Coolant Through



Reinforced Straight Shank

Speeds & Feeds
information pg 481

Series 5510

RT 100 U High Penetration

Carbide, RT 100 U high penetration, 3xD, self-centering
140° SU point, reinforced straight shank, RH helix

Cut Dia. = m7 tolerance range, Shank Dia. = h6

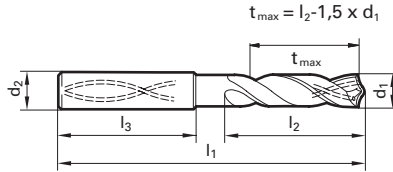

Application Materials:

- General Steels/Brass
- Universal Steels
- Stainless Steels
- Hardened Materials
- Cast Iron
- Ti & Ni Alloys

Twist Drills



Diameter (d1)			mm	d2 mm	l1 mm	l2 mm	EDP #
Dec. inch	Fract. inch	Wire / letter					
0.1181			3.000	6.000	62.00	20.00	9055100030000
0.1220			3.100	6.000	62.00	20.00	9055100031000
0.1248	1/8		3.170	6.000	62.00	20.00	9055100031700
0.1260			3.200	6.000	62.00	20.00	9055100032000
0.1280			3.250	6.000	62.00	20.00	9055100032500
0.1299			3.300	6.000	62.00	20.00	9055100033000
0.1339			3.400	6.000	62.00	20.00	9055100034000
0.1378			3.500	6.000	62.00	20.00	9055100035000
0.1406	9/64	28	3.570	6.000	62.00	20.00	9055100035700
0.1417			3.600	6.000	62.00	20.00	9055100036000
0.1457			3.700	6.000	62.00	20.00	9055100037000
0.1496		25	3.800	6.000	66.00	24.00	9055100038000
0.1535			3.900	6.000	66.00	24.00	9055100039000
0.1563	5/32		3.970	6.000	66.00	24.00	9055100039700
0.1575			4.000	6.000	66.00	24.00	9055100040000
0.1591		21	4.040	6.000	66.00	24.00	9055100040400
0.1614			4.100	6.000	66.00	24.00	9055100041000
0.1654			4.200	6.000	66.00	24.00	9055100042000
0.1693			4.300	6.000	66.00	24.00	9055100043000
0.1720	11/64		4.370	6.000	66.00	24.00	9055100043700
0.1732			4.400	6.000	66.00	24.00	9055100044000
0.1772		16	4.500	6.000	66.00	24.00	9055100045000
0.1811			4.600	6.000	66.00	24.00	9055100046000
0.1831			4.650	6.000	66.00	24.00	9055100046500
0.1850		13	4.700	6.000	66.00	28.00	9055100047000
0.1874	3/16		4.760	6.000	66.00	28.00	9055100047600
0.1890		12	4.800	6.000	66.00	28.00	9055100048000
0.1929			4.900	6.000	66.00	28.00	9055100049000
0.1969			5.000	6.000	66.00	28.00	9055100050000
0.2008			5.100	6.000	66.00	28.00	9055100051000
0.2012		7	5.110	6.000	66.00	28.00	9055100051100
0.2031	13/64		5.160	6.000	66.00	28.00	9055100051600
0.2047			5.200	6.000	66.00	28.00	9055100052000
0.2067			5.250	6.000	66.00	28.00	9055100052500
0.2087			5.300	6.000	66.00	28.00	9055100053000
0.2126			5.400	6.000	66.00	28.00	9055100054000
0.2130		3	5.410	6.000	66.00	28.00	9055100054100
0.2165			5.500	6.000	66.00	28.00	9055100055000
0.2185			5.550	6.000	66.00	28.00	9055100055500
0.2189	7/32		5.560	6.000	66.00	28.00	9055100055600
0.2205			5.600	6.000	66.00	28.00	9055100056000
0.2244			5.700	6.000	66.00	28.00	9055100057000
0.2283			5.800	6.000	66.00	28.00	9055100058000
0.2323			5.900	6.000	66.00	28.00	9055100059000
0.2343	15/64		5.950	6.000	66.00	28.00	9055100059500
0.2362			6.000	6.000	66.00	28.00	9055100060000
0.2402			6.100	8.000	79.00	34.00	9055100061000
0.2441			6.200	8.000	79.00	34.00	9055100062000
0.2480			6.300	8.000	79.00	34.00	9055100063000
0.2500	1/4	E	6.350	8.000	79.00	34.00	9055100063500

Diameter (d1)			mm	d2 mm	l1 mm	l2 mm	EDP #
Dec. inch	Fract. inch	Wire / letter					
0.2520			6.400	8.000	79.00	34.00	9055100064000
0.2559			6.500	8.000	79.00	34.00	9055100065000
0.2571		F	6.530	8.000	79.00	34.00	9055100065300
0.2598			6.600	8.000	79.00	34.00	9055100066000
0.2638			6.700	8.000	79.00	34.00	9055100067000
0.2657	17/64	H	6.750	8.000	79.00	34.00	9055100067500
0.2677			6.800	8.000	79.00	34.00	9055100068000
0.2717		I	6.900	8.000	79.00	34.00	9055100069000
0.2756			7.000	8.000	79.00	34.00	9055100070000
0.2795			7.100	8.000	79.00	41.00	9055100071000
0.2811	9/32	K	7.140	8.000	79.00	41.00	9055100071400
0.2835			7.200	8.000	79.00	41.00	9055100072000
0.2874			7.300	8.000	79.00	41.00	9055100073000
0.2913			7.400	8.000	79.00	41.00	9055100074000
0.2953			7.500	8.000	79.00	41.00	9055100075000
0.2969	19/64		7.540	8.000	79.00	41.00	9055100075400
0.2992			7.600	8.000	79.00	41.00	9055100076000
0.3031			7.700	8.000	79.00	41.00	9055100077000
0.3071			7.800	8.000	79.00	41.00	9055100078000
0.3110			7.900	8.000	79.00	41.00	9055100079000
0.3126	5/16		7.940	8.000	79.00	41.00	9055100079400
0.3150			8.000	8.000	79.00	41.00	9055100080000
0.3189			8.100	10.000	89.00	47.00	9055100081000
0.3228		P	8.200	10.000	89.00	47.00	9055100082000
0.3268			8.300	10.000	89.00	47.00	9055100083000
0.3280	21/64		8.330	10.000	89.00	47.00	9055100083300
0.3307			8.400	10.000	89.00	47.00	9055100084000
0.3346			8.500	10.000	89.00	47.00	9055100085000
0.3386			8.600	10.000	89.00	47.00	9055100086000
0.3425			8.700	10.000	89.00	47.00	9055100087000
0.3437	11/32		8.730	10.000	89.00	47.00	9055100087300
0.3465			8.800	10.000	89.00	47.00	9055100088000
0.3504			8.900	10.000	89.00	47.00	9055100089000
0.3543			9.000	10.000	89.00	47.00	9055100090000
0.3583			9.100	10.000	89.00	47.00	9055100091000
0.3594	23/64		9.130	10.000	89.00	47.00	9055100091300
0.3622			9.200	10.000	89.00	47.00	9055100092000
0.3642			9.250	10.000	89.00	47.00	9055100092500
0.3661			9.300	10.000	89.00	47.00	9055100093000
0.3677		U	9.340	10.000	89.00	47.00	9055100093400
0.3701			9.400	10.000	89.00	47.00	9055100094000
0.3740			9.500	10.000	89.00	47.00	9055100095000
0.3748	3/8		9.520	10.000	89.00	47.00	9055100095200
0.3780			9.600	10.000	89.00	47.00	9055100096000
0.3819			9.700	10.000	89.00	47.00	9055100097000
0.3858		W	9.800	10.000	89.00	47.00	9055100098000
0.3898			9.900	10.000	89.00	47.00	9055100099000
0.3906	25/64		9.920	10.000	89.00	47.00	9055100099200
0.3937			10.000	10.000	89.00	47.00	9055100100000
0.3976			10.100	12.000	102.00	55.00	9055100101000

*Items listed in red are non-stocked items, and may take 2 - 6 weeks to receive

Series 5510

Speeds & Feeds information pg 481

Dec. inch	Diameter (d1)		d2 mm	l1 mm	l2 mm	EDP #	
	Fract. inch	Wire / letter					
0.4016			10.200	12.000	102.00	55.00	9055100102000
0.4055			10.300	12.000	102.00	55.00	9055100103000
0.4063	13/32		10.320	12.000	102.00	55.00	9055100103200
0.4094			10.400	12.000	102.00	55.00	9055100104000
0.4134			10.500	12.000	102.00	55.00	9055100105000
0.4173			10.600	12.000	102.00	55.00	9055100106000
0.4213			10.700	12.000	102.00	55.00	9055100107000
0.4220	27/64		10.720	12.000	102.00	55.00	9055100107200
0.4252			10.800	12.000	102.00	55.00	9055100108000
0.4291			10.900	12.000	102.00	55.00	9055100109000
0.4331			11.000	12.000	102.00	55.00	9055100110000
0.4370			11.100	12.000	102.00	55.00	9055100111000
0.4374	7/16		11.110	12.000	102.00	55.00	9055100111100
0.4409			11.200	12.000	102.00	55.00	9055100112000
0.4449			11.300	12.000	102.00	55.00	9055100113000
0.4488			11.400	12.000	102.00	55.00	9055100114000
0.4528			11.500	12.000	102.00	55.00	9055100115000
0.4531	29/64		11.510	12.000	102.00	55.00	9055100115100
0.4567			11.600	12.000	102.00	55.00	9055100116000
0.4606			11.700	12.000	102.00	55.00	9055100117000
0.4645			11.800	12.000	102.00	55.00	9055100118000
0.4685			11.900	12.000	102.00	55.00	9055100119000
0.4689	15/32		11.910	12.000	102.00	55.00	9055100119100
0.4724			12.000	12.000	102.00	55.00	9055100120000
0.4764			12.100	14.000	107.00	60.00	9055100121000
0.4803			12.200	14.000	107.00	60.00	9055100122000
0.4843	31/64		12.300	14.000	107.00	60.00	9055100123000
0.4882			12.400	14.000	107.00	60.00	9055100124000
0.4921			12.500	14.000	107.00	60.00	9055100125000
0.4961			12.600	14.000	107.00	60.00	9055100126000
0.5000	1/2		12.700	14.000	107.00	60.00	9055100127000
0.5039			12.800	14.000	107.00	60.00	9055100128000
0.5079			12.900	14.000	107.00	60.00	9055100129000
0.5118			13.000	14.000	107.00	60.00	9055100130000
0.5157			13.100	14.000	107.00	60.00	9055100131000
0.5197			13.200	14.000	107.00	60.00	9055100132000
0.5236			13.300	14.000	107.00	60.00	9055100133000
0.5276			13.400	14.000	107.00	60.00	9055100134000
0.5311	17/32		13.490	14.000	107.00	60.00	9055100134900
0.5315			13.500	14.000	107.00	60.00	9055100135000
0.5354			13.600	14.000	107.00	60.00	9055100136000
0.5394			13.700	14.000	107.00	60.00	9055100137000
0.5433			13.800	14.000	107.00	60.00	9055100138000
0.5469	35/64		13.890	14.000	107.00	60.00	9055100138900
0.5472			13.900	14.000	107.00	60.00	9055100139000
0.5512			14.000	14.000	107.00	60.00	9055100140000
0.5551			14.100	16.000	115.00	65.00	9055100141000
0.5591			14.200	16.000	115.00	65.00	9055100142000
0.5626	9/16		14.290	16.000	115.00	65.00	9055100142900
0.5630			14.300	16.000	115.00	65.00	9055100143000

Dec. inch	Diameter (d1)		d2 mm	l1 mm	l2 mm	EDP #	
	Fract. inch	Wire / letter					
0.5669			14.400	16.000	115.00	65.00	9055100144000
0.5709			14.500	16.000	115.00	65.00	9055100145000
0.5748			14.600	16.000	115.00	65.00	9055100146000
0.5780	37/64		14.680	16.000	115.00	65.00	9055100146800
0.5787			14.700	16.000	115.00	65.00	9055100147000
0.5827			14.800	16.000	115.00	65.00	9055100148000
0.5866			14.900	16.000	115.00	65.00	9055100149000
0.5906			15.000	16.000	115.00	65.00	9055100150000
0.5937	19/32		15.080	16.000	115.00	65.00	9055100150800
0.5945			15.100	16.000	115.00	65.00	9055100151000
0.5984			15.200	16.000	115.00	65.00	9055100152000
0.6024			15.300	16.000	115.00	65.00	9055100153000
0.6063			15.400	16.000	115.00	65.00	9055100154000
0.6094	39/64		15.480	16.000	115.00	65.00	9055100154800
0.6102			15.500	16.000	115.00	65.00	9055100155000
0.6142			15.600	16.000	115.00	65.00	9055100156000
0.6181			15.700	16.000	115.00	65.00	9055100157000
0.6220			15.800	16.000	115.00	65.00	9055100158000
0.6248	5/8		15.870	16.000	115.00	65.00	9055100158700
0.6260			15.900	16.000	115.00	65.00	9055100159000
0.6299			16.000	16.000	115.00	65.00	9055100160000
0.6378			16.200	18.000	115.00	65.00	9055100162000
0.6406	41/64		16.270	18.000	115.00	65.00	9055100162700
0.6496			16.500	18.000	123.00	73.00	9055100165000
0.6563	21/32		16.670	18.000	123.00	73.00	9055100166700
0.6654			16.900	18.000	123.00	73.00	9055100169000
0.6693			17.000	18.000	123.00	73.00	9055100170000
0.6720	43/64		17.070	18.000	123.00	73.00	9055100170700
0.6874	11/16		17.460	18.000	123.00	73.00	9055100174600
0.6890			17.500	18.000	123.00	73.00	9055100175000
0.6929			17.600	18.000	123.00	73.00	9055100176000
0.6968			17.700	18.000	123.00	73.00	9055100177000
0.7031	45/64		17.860	18.000	123.00	73.00	9055100178600
0.7087			18.000	18.000	123.00	73.00	9055100180000
0.7189	23/32		18.260	20.000	131.00	79.00	9055100182600
0.7283			18.500	20.000	131.00	79.00	9055100185000
0.7441			18.900	20.000	131.00	79.00	9055100189000
0.7480			19.000	20.000	131.00	79.00	9055100190000
0.7500	3/4		19.050	20.000	131.00	79.00	9055100190500
0.7579			19.250	20.000	131.00	79.00	9055100192500
0.7656	49/64		19.446	20.000	131.00	79.00	9055100194460
0.7677			19.500	20.000	131.00	79.00	9055100195000
0.7811	25/32		19.840	20.000	131.00	79.00	9055100198400
0.7874			20.000	20.000	131.00	79.00	9055100200000

Alternative Drill Series:

#2477 Carbide, RT100U, 3xD, 140 U pt, nano-FIREX®

#8510 Carbide, RT100VA, 3xD, 140 VA pt, nano-A

5xD

Series 5511

RT 100 U High Penetration

Carbide, RT 100 U high penetration, 5xD, self-centering
140° SU point, reinforced straight shank, RH helix

Cut Dia. = m7 tolerance range, Shank Dia. = h6

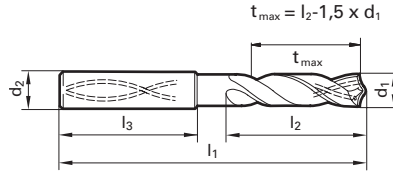

Application Materials:

- General Steels/Brass
- Universal Steels
- Stainless Steels
- Hardened Materials
- Cast Iron
- Ti & Ni Alloys

Twist Drills

F

FIREX® coated



Coolant Through

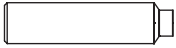

Reinforced Straight Shank

Speeds & Feeds
information pg 481



Diameter (d1)		Wire / letter	mm	d2 mm	l1 mm	l2 mm	EDP #
Dec. inch	Fract. inch						
0.1181			3.000	6.000	66.00	28.00	9055110030000
0.1220			3.100	6.000	66.00	28.00	9055110031000
0.1248	1/8		3.170	6.000	66.00	28.00	9055110031700
0.1260			3.200	6.000	66.00	28.00	9055110032000
0.1280			3.250	6.000	66.00	28.00	9055110032500
0.1299			3.300	6.000	66.00	28.00	9055110033000
0.1339			3.400	6.000	66.00	28.00	9055110034000
0.1378			3.500	6.000	66.00	28.00	9055110035000
0.1406	9/64	28	3.570	6.000	66.00	28.00	9055110035700
0.1417			3.600	6.000	66.00	28.00	9055110036000
0.1457			3.700	6.000	66.00	28.00	9055110037000
0.1496		25	3.800	6.000	74.00	36.00	9055110038000
0.1535			3.900	6.000	74.00	36.00	9055110039000
0.1563	5/32		3.970	6.000	74.00	36.00	9055110039700
0.1575			4.000	6.000	74.00	36.00	9055110040000
0.1591		21	4.040	6.000	74.00	36.00	9055110040400
0.1614			4.100	6.000	74.00	36.00	9055110041000
0.1654			4.200	6.000	74.00	36.00	9055110042000
0.1693		18	4.300	6.000	74.00	36.00	9055110043000
0.1720	11/64		4.370	6.000	74.00	36.00	9055110043700
0.1732			4.400	6.000	74.00	36.00	9055110044000
0.1772		16	4.500	6.000	74.00	36.00	9055110045000
0.1811			4.600	6.000	74.00	36.00	9055110046000
0.1831			4.650	6.000	74.00	36.00	9055110046500
0.1850		13	4.700	6.000	74.00	36.00	9055110047000
0.1874	3/16		4.760	6.000	82.00	44.00	9055110047600
0.1890		12	4.800	6.000	82.00	44.00	9055110048000
0.1929			4.900	6.000	82.00	44.00	9055110049000
0.1969			5.000	6.000	82.00	44.00	9055110050000
0.2008			5.100	6.000	82.00	44.00	9055110051000
0.2012		7	5.110	6.000	82.00	44.00	9055110051100
0.2031	13/64		5.160	6.000	82.00	44.00	9055110051600
0.2047			5.200	6.000	82.00	44.00	9055110052000
0.2067			5.250	6.000	82.00	44.00	9055110052500
0.2087			5.300	6.000	82.00	44.00	9055110053000
0.2126			5.400	6.000	82.00	44.00	9055110054000
0.2130		3	5.410	6.000	82.00	44.00	9055110054100
0.2165			5.500	6.000	82.00	44.00	9055110055000
0.2185			5.550	6.000	82.00	44.00	9055110055500
0.2189	7/32		5.560	6.000	82.00	44.00	9055110055600
0.2205			5.600	6.000	82.00	44.00	9055110056000
0.2244			5.700	6.000	82.00	44.00	9055110057000
0.2283			5.800	6.000	82.00	44.00	9055110058000
0.2323			5.900	6.000	82.00	44.00	9055110059000
0.2343	15/64		5.950	6.000	82.00	44.00	9055110059500
0.2362			6.000	6.000	82.00	44.00	9055110060000
0.2402			6.100	8.000	91.00	53.00	9055110061000
0.2441			6.200	8.000	91.00	53.00	9055110062000
0.2480			6.300	8.000	91.00	53.00	9055110063000
0.2500	1/4	E	6.350	8.000	91.00	53.00	9055110063500

Diameter (d1)		Wire / letter	mm	d2 mm	l1 mm	l2 mm	EDP #
Dec. inch	Fract. inch						
0.2520			6.400	8.000	91.00	53.00	9055110064000
0.2559			6.500	8.000	91.00	53.00	9055110065000
0.2571		F	6.530	8.000	91.00	53.00	9055110065300
0.2598			6.600	8.000	91.00	53.00	9055110066000
0.2638			6.700	8.000	91.00	53.00	9055110067000
0.2657	17/64	H	6.750	8.000	91.00	53.00	9055110067500
0.2677			6.800	8.000	91.00	53.00	9055110068000
0.2717		I	6.900	8.000	91.00	53.00	9055110069000
0.2756			7.000	8.000	91.00	53.00	9055110070000
0.2795			7.100	8.000	91.00	53.00	9055110071000
0.2811	9/32	K	7.140	8.000	91.00	53.00	9055110071400
0.2835			7.200	8.000	91.00	53.00	9055110072000
0.2874			7.300	8.000	91.00	53.00	9055110073000
0.2913			7.400	8.000	91.00	53.00	9055110074000
0.2953			7.500	8.000	91.00	53.00	9055110075000
0.2969	19/64		7.540	8.000	91.00	53.00	9055110075400
0.2992			7.600	8.000	91.00	53.00	9055110076000
0.3031			7.700	8.000	91.00	53.00	9055110077000
0.3071			7.800	8.000	91.00	53.00	9055110078000
0.3110			7.900	8.000	91.00	53.00	9055110079000
0.3126	5/16		7.940	8.000	91.00	53.00	9055110079400
0.3150			8.000	8.000	91.00	53.00	9055110080000
0.3189			8.100	10.000	103.00	61.00	9055110081000
0.3228		P	8.200	10.000	103.00	61.00	9055110082000
0.3268			8.300	10.000	103.00	61.00	9055110083000
0.3280	21/64		8.330	10.000	103.00	61.00	9055110083300
0.3307			8.400	10.000	103.00	61.00	9055110084000
0.3346			8.500	10.000	103.00	61.00	9055110085000
0.3386			8.600	10.000	103.00	61.00	9055110086000
0.3425			8.700	10.000	103.00	61.00	9055110087000
0.3437	11/32		8.730	10.000	103.00	61.00	9055110087300
0.3465			8.800	10.000	103.00	61.00	9055110088000
0.3504			8.900	10.000	103.00	61.00	9055110089000
0.3543			9.000	10.000	103.00	61.00	9055110090000
0.3583			9.100	10.000	103.00	61.00	9055110091000
0.3594	23/64		9.130	10.000	103.00	61.00	9055110091300
0.3622			9.200	10.000	103.00	61.00	9055110092000
0.3642			9.250	10.000	103.00	61.00	9055110092500
0.3661			9.300	10.000	103.00	61.00	9055110093000
0.3677		U	9.340	10.000	103.00	61.00	9055110093400
0.3701			9.400	10.000	103.00	61.00	9055110094000
0.3740			9.500	10.000	103.00	61.00	9055110095000
0.3748	3/8		9.520	10.000	103.00	61.00	9055110095200
0.3780			9.600	10.000	103.00	61.00	9055110096000
0.3819			9.700	10.000	103.00	61.00	9055110097000
0.3858		W	9.800	10.000	103.00	61.00	9055110098000
0.3898			9.900	10.000	103.00	61.00	9055110099000
0.3906	25/64		9.920	10.000	103.00	61.00	9055110099200
0.3937			10.000	10.000	103.00	61.00	9055110100000
0.3976			10.100	12.000	118.00	71.00	9055110101000

*Items listed in red are non-stocked items, and may take 2 - 6 weeks to receive

Series 5511

Speeds & Feeds information pg 481

Dec. inch	Diameter (d1)		d2 mm	l1 mm	l2 mm	EDP #	
	Fract. inch	Wire / letter					
0.4016			10.200	12.000	118.00	71.00	9055110102000
0.4055			10.300	12.000	118.00	71.00	9055110103000
0.4063	13/32		10.320	12.000	118.00	71.00	9055110103200
0.4094			10.400	12.000	118.00	71.00	9055110104000
0.4134			10.500	12.000	118.00	71.00	9055110105000
0.4173			10.600	12.000	118.00	71.00	9055110106000
0.4213			10.700	12.000	118.00	71.00	9055110107000
0.4220	27/64		10.720	12.000	118.00	71.00	9055110107200
0.4252			10.800	12.000	118.00	71.00	9055110108000
0.4291			10.900	12.000	118.00	71.00	9055110109000
0.4331			11.000	12.000	118.00	71.00	9055110110000
0.4370			11.100	12.000	118.00	71.00	9055110111000
0.4374	7/16		11.110	12.000	118.00	71.00	9055110111100
0.4409			11.200	12.000	118.00	71.00	9055110112000
0.4449			11.300	12.000	118.00	71.00	9055110113000
0.4488			11.400	12.000	118.00	71.00	9055110114000
0.4528			11.500	12.000	118.00	71.00	9055110115000
0.4531	29/64		11.510	12.000	118.00	71.00	9055110115100
0.4567			11.600	12.000	118.00	71.00	9055110116000
0.4606			11.700	12.000	118.00	71.00	9055110117000
0.4646			11.800	12.000	118.00	71.00	9055110118000
0.4685			11.900	12.000	118.00	71.00	9055110119000
0.4689	15/32		11.910	12.000	118.00	71.00	9055110119100
0.4724			12.000	12.000	118.00	71.00	9055110120000
0.4764			12.100	14.000	124.00	77.00	9055110121000
0.4803			12.200	14.000	124.00	77.00	9055110122000
0.4843	31/64		12.300	14.000	124.00	77.00	9055110123000
0.4882			12.400	14.000	124.00	77.00	9055110124000
0.4921			12.500	14.000	124.00	77.00	9055110125000
0.4961			12.600	14.000	124.00	77.00	9055110126000
0.5000	1/2		12.700	14.000	124.00	77.00	9055110127000
0.5039			12.800	14.000	124.00	77.00	9055110128000
0.5079			12.900	14.000	124.00	77.00	9055110129000
0.5118			13.000	14.000	124.00	77.00	9055110130000
0.5157			13.100	14.000	124.00	77.00	9055110131000
0.5197			13.200	14.000	124.00	77.00	9055110132000
0.5236			13.300	14.000	124.00	77.00	9055110133000
0.5276			13.400	14.000	124.00	77.00	9055110134000
0.5311	17/32		13.490	14.000	124.00	77.00	9055110134900
0.5315			13.500	14.000	124.00	77.00	9055110135000
0.5354			13.600	14.000	124.00	77.00	9055110136000
0.5394			13.700	14.000	124.00	77.00	9055110137000
0.5433			13.800	14.000	124.00	77.00	9055110138000
0.5469	35/64		13.890	14.000	124.00	77.00	9055110138900
0.5472			13.900	14.000	124.00	77.00	9055110139000
0.5512			14.000	14.000	124.00	77.00	9055110140000
0.5551			14.100	16.000	133.00	83.00	9055110141000
0.5591			14.200	16.000	133.00	83.00	9055110142000
0.5626	9/16		14.290	16.000	133.00	83.00	9055110142900
0.5630			14.300	16.000	133.00	83.00	9055110143000
0.5669			14.400	16.000	133.00	83.00	9055110144000
0.5709			14.500	16.000	133.00	83.00	9055110145000

Dec. inch	Diameter (d1)		d2 mm	l1 mm	l2 mm	EDP #	
	Fract. inch	Wire / letter					
0.5748			14.600	16.000	133.00	83.00	9055110146000
0.5780	37/64		14.680	16.000	133.00	83.00	9055110146800
0.5787			14.700	16.000	133.00	83.00	9055110147000
0.5827			14.800	16.000	133.00	83.00	9055110148000
0.5866			14.900	16.000	133.00	83.00	9055110149000
0.5906			15.000	16.000	133.00	83.00	9055110150000
0.5937	19/32		15.080	16.000	133.00	83.00	9055110150800
0.5945			15.100	16.000	133.00	83.00	9055110151000
0.5984			15.200	16.000	133.00	83.00	9055110152000
0.6024			15.300	16.000	133.00	83.00	9055110153000
0.6063			15.400	16.000	133.00	83.00	9055110154000
0.6094	39/64		15.480	16.000	133.00	83.00	9055110154800
0.6102			15.500	16.000	133.00	83.00	9055110155000
0.6142			15.600	16.000	133.00	83.00	9055110156000
0.6181			15.700	16.000	133.00	83.00	9055110157000
0.6220			15.800	16.000	133.00	83.00	9055110158000
0.6248	5/8		15.870	16.000	133.00	83.00	9055110158700
0.6260			15.900	16.000	133.00	83.00	9055110159000
0.6299			16.000	16.000	133.00	83.00	9055110160000
0.6331			16.080	18.000	143.00	93.00	9055110160800
0.6406	41/64		16.270	18.000	143.00	93.00	9055110162700
0.6496			16.500	18.000	143.00	93.00	9055110165000
0.6563	21/32		16.670	18.000	143.00	93.00	9055110166700
0.6575			16.700	18.000	143.00	93.00	9055110167000
0.6654			16.900	18.000	143.00	93.00	9055110169000
0.6693			17.000	18.000	143.00	93.00	9055110170000
0.6720	43/64		17.070	18.000	143.00	93.00	9055110170700
0.6874	11/16		17.460	18.000	143.00	93.00	9055110174600
0.6890			17.500	18.000	143.00	93.00	9055110175000
0.6969			17.700	18.000	143.00	93.00	9055110177000
0.7031	45/64		17.860	18.000	143.00	93.00	9055110178600
0.7087			18.000	18.000	143.00	93.00	9055110180000
0.7283			18.500	20.000	153.00	101.00	9055110185000
0.7362			18.700	20.000	153.00	101.00	9055110187000
0.7441			18.900	20.000	153.00	101.00	9055110189000
0.7480			19.000	20.000	153.00	101.00	9055110190000
0.7500	3/4		19.050	20.000	153.00	101.00	9055110190500
0.7543			19.160	20.000	153.00	101.00	9055110191600
0.7579			19.250	20.000	153.00	101.00	9055110192500
0.7598			19.300	20.000	153.00	101.00	9055110193000
0.7656	49/64		19.446	20.000	153.00	101.00	9055110194460
0.7677			19.500	20.000	153.00	101.00	9055110195000
0.7756			19.700	20.000	153.00	101.00	9055110197000
0.7811	25/32		19.840	20.000	153.00	101.00	9055110198400
0.7874			20.000	20.000	153.00	101.00	9055110200000

Alternative Drill Series:

- #2479 Carbide, RT100, 5xD, 140 U pt, nano-FIREX®
- #8511 Carbide, RT100VA, 5xD, 140 VA pt, nano-A
- #5611 Carbide, RT100, 5xD, 140 U pt, FIREX®
- #1662 Carbide, RT100, 5xD, 140 F pt, TiN

7xD

Series 5512

RT 100 U High Penetration

Carbide, RT 100 U high penetration, 7xD, self-centering
140° SU point, double margin, reinforced straight shank, RH helix

Cut Dia. = m7 tolerance range, Shank Dia. = h6

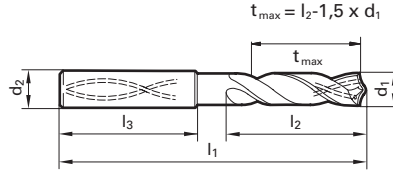

F

FIRES® coated



Coolant Through



Reinforced Straight Shank

Speeds & Feeds
information pg 482

Application Materials:

- General Steels/Brass
- Universal Steels
- Stainless Steels
- Hardened Materials
- Cast Iron
- Ti & Ni Alloys

Twist Drills



Diameter (d1)		Wire / letter	mm	d2 mm	l1 mm	l2 mm	EDP #
Dec. inch	Fract. inch						
0.1181			3.000	6.000	70.00	30.00	9055120030000
0.1220			3.100	6.000	70.00	30.00	9055120031000
0.1248	1/8		3.170	6.000	70.00	30.00	9055120031700
0.1260			3.200	6.000	70.00	30.00	9055120032000
0.1280			3.250	6.000	70.00	30.00	9055120032500
0.1299			3.300	6.000	70.00	30.00	9055120033000
0.1339			3.400	6.000	75.00	37.50	9055120034000
0.1378			3.500	6.000	75.00	37.50	9055120035000
0.1406	9/64	28	3.570	6.000	75.00	37.50	9055120035700
0.1417			3.600	6.000	75.00	37.50	9055120036000
0.1457			3.700	6.000	75.00	37.50	9055120037000
0.1496		25	3.800	6.000	75.00	37.50	9055120038000
0.1535			3.900	6.000	75.00	37.50	9055120039000
0.1563	5/32		3.970	6.000	75.00	37.50	9055120039700
0.1575			4.000	6.000	75.00	37.50	9055120040000
0.1591		21	4.040	6.000	75.00	37.50	9055120040400
0.1614			4.100	6.000	75.00	37.50	9055120041000
0.1654			4.200	6.000	75.00	37.50	9055120042000
0.1693			4.300	6.000	85.00	45.00	9055120043000
0.1720	11/64		4.370	6.000	85.00	45.00	9055120043700
0.1732			4.400	6.000	85.00	45.00	9055120044000
0.1772			4.500	6.000	85.00	45.00	9055120045000
0.1811			4.600	6.000	85.00	45.00	9055120046000
0.1830			4.650	6.000	85.00	45.00	9055120046500
0.1850			4.700	6.000	85.00	45.00	9055120047000
0.1874	3/16		4.760	6.000	90.00	50.00	9055120047600
0.1890			4.800	6.000	90.00	50.00	9055120048000
0.1929			4.900	6.000	90.00	50.00	9055120049000
0.1969			5.000	6.000	90.00	50.00	9055120050000
0.2008			5.100	6.000	90.00	50.00	9055120051000
0.2012		7	5.110	6.000	90.00	50.00	9055120051100
0.2031	13/64		5.160	6.000	90.00	50.00	9055120051600
0.2047			5.200	6.000	90.00	50.00	9055120052000
0.2067			5.250	6.000	90.00	50.00	9055120052500
0.2087			5.300	6.000	90.00	50.00	9055120053000
0.2126			5.400	6.000	90.00	50.00	9055120054000
0.2130		3	5.410	6.000	90.00	50.00	9055120054100
0.2165			5.500	6.000	97.00	57.00	9055120055000
0.2189	7/32		5.560	6.000	97.00	57.00	9055120055600
0.2205			5.600	6.000	97.00	57.00	9055120056000
0.2244			5.700	6.000	97.00	57.00	9055120057000
0.2283			5.800	6.000	97.00	57.00	9055120058000
0.2323			5.900	6.000	97.00	57.00	9055120059000
0.2343	15/64		5.950	6.000	97.00	57.00	9055120059500
0.2362			6.000	6.000	97.00	57.00	9055120060000
0.2402			6.100	8.000	106.00	66.00	9055120061000
0.2441			6.200	8.000	106.00	66.00	9055120062000
0.2480			6.300	8.000	106.00	66.00	9055120063000
0.2500	1/4	E	6.350	8.000	106.00	66.00	9055120063500
0.2520			6.400	8.000	106.00	66.00	9055120064000

Diameter (d1)		Wire / letter	mm	d2 mm	l1 mm	l2 mm	EDP #
Dec. inch	Fract. inch						
0.2559			6.500	8.000	106.00	66.00	9055120065000
0.2571		F	6.530	8.000	106.00	66.00	9055120065300
0.2598			6.600	8.000	106.00	66.00	9055120066000
0.2638			6.700	8.000	106.00	66.00	9055120067000
0.2657	17/64	H	6.750	8.000	106.00	66.00	9055120067500
0.2677			6.800	8.000	106.00	66.00	9055120068000
0.2717		I	6.900	8.000	116.00	76.00	9055120069000
0.2756			7.000	8.000	116.00	76.00	9055120070000
0.2795			7.100	8.000	116.00	76.00	9055120071000
0.2811	9/32	K	7.140	8.000	116.00	76.00	9055120071400
0.2835			7.200	8.000	116.00	76.00	9055120072000
0.2874			7.300	8.000	116.00	76.00	9055120073000
0.2913			7.400	8.000	116.00	76.00	9055120074000
0.2953			7.500	8.000	116.00	76.00	9055120075000
0.2969	19/64		7.540	8.000	116.00	76.00	9055120075400
0.2992			7.600	8.000	116.00	76.00	9055120076000
0.3031			7.700	8.000	116.00	76.00	9055120077000
0.3071			7.800	8.000	116.00	76.00	9055120078000
0.3110			7.900	8.000	116.00	76.00	9055120079000
0.3126	5/16		7.940	8.000	116.00	76.00	9055120079400
0.3150			8.000	8.000	116.00	76.00	9055120080000
0.3189			8.100	10.000	131.00	87.00	9055120081000
0.3228		P	8.200	10.000	131.00	87.00	9055120082000
0.3268			8.300	10.000	131.00	87.00	9055120083000
0.3280	21/64		8.330	10.000	131.00	87.00	9055120083300
0.3307			8.400	10.000	131.00	87.00	9055120084000
0.3346			8.500	10.000	131.00	87.00	9055120085000
0.3386			8.600	10.000	131.00	87.00	9055120086000
0.3425			8.700	10.000	131.00	87.00	9055120087000
0.3437	11/32		8.730	10.000	131.00	87.00	9055120087300
0.3465			8.800	10.000	131.00	87.00	9055120088000
0.3504			8.900	10.000	131.00	87.00	9055120089000
0.3543			9.000	10.000	131.00	87.00	9055120090000
0.3583			9.100	10.000	139.00	95.00	9055120091000
0.3594	23/64		9.130	10.000	139.00	95.00	9055120091300
0.3622			9.200	10.000	139.00	95.00	9055120092000
0.3642			9.250	10.000	139.00	95.00	9055120092500
0.3661			9.300	10.000	139.00	95.00	9055120093000
0.3677		U	9.340	10.000	139.00	95.00	9055120093400
0.3701			9.400	10.000	139.00	95.00	9055120094000
0.3740			9.500	10.000	139.00	95.00	9055120095000
0.3748	3/8		9.520	10.000	139.00	95.00	9055120095200
0.3780			9.600	10.000	139.00	95.00	9055120096000
0.3819			9.700	10.000	139.00	95.00	9055120097000
0.3858		W	9.800	10.000	139.00	95.00	9055120098000
0.3898			9.900	10.000	139.00	95.00	9055120099000
0.3906	25/64		9.920	10.000	139.00	95.00	9055120099200
0.3937			10.000	10.000	139.00	95.00	9055120100000
0.3976			10.100	12.000	155.00	106.00	9055120101000
0.3997			10.200	12.000	155.00	106.00	9055120102000

*Items listed in red are non-stocked items, and may take 2 - 6 weeks to receive

Series 5512

Speeds & Feeds information pg 482

Dec. inch	Diameter (d1)			d2 mm	l1 mm	l2 mm	EDP #
	Fract. inch	Wire / letter	mm				
0.4055			10.300	12.000	155.00	106.00	9055120103000
0.4063	13/32		10.320	12.000	155.00	106.00	9055120103200
0.4094			10.400	12.000	155.00	106.00	9055120104000
0.4134			10.500	12.000	155.00	106.00	9055120105000
0.4173			10.600	12.000	155.00	106.00	9055120106000
0.4213			10.700	12.000	155.00	106.00	9055120107000
0.4220	27/64		10.720	12.000	155.00	106.00	9055120107200
0.4252			10.800	12.000	155.00	106.00	9055120108000
0.4291			10.900	12.000	155.00	106.00	9055120109000
0.4331			11.000	12.000	155.00	106.00	9055120110000
0.4370			11.100	12.000	155.00	106.00	9055120111000
0.4374	7/16		11.110	12.000	163.00	114.00	9055120111100
0.4409			11.200	12.000	163.00	114.00	9055120112000
0.4449			11.300	12.000	155.00	114.00	9055120113000
0.4488			11.400	12.000	155.00	114.00	9055120114000
0.4528			11.500	12.000	163.00	114.00	9055120115000
0.4531	29/64		11.510	12.000	155.00	114.00	9055120115100
0.4567			11.600	12.000	155.00	114.00	9055120116000
0.4606			11.700	12.000	155.00	114.00	9055120117000
0.4646			11.800	12.000	163.00	114.00	9055120118000
0.4685			11.900	12.000	155.00	114.00	9055120119000
0.4689	15/32		11.910	12.000	163.00	114.00	9055120119100
0.4724			12.000	12.000	163.00	114.00	9055120120000
0.4764			12.100	14.000	182.00	133.00	9055120121000
0.4803			12.200	14.000	182.00	133.00	9055120122000
0.4843	31/64		12.300	14.000	182.00	133.00	9055120123000
0.4921			12.500	14.000	182.00	133.00	9055120125000
0.5000	1/2		12.700	14.000	182.00	133.00	9055120127000
0.5118			13.000	14.000	182.00	133.00	9055120130000
0.5157			13.100	14.000	182.00	133.00	9055120131000
0.5311	17/32		13.490	14.000	182.00	133.00	9055120134900
0.5315			13.500	14.000	182.00	133.00	9055120135000

Dec. inch	Diameter (d1)			d2 mm	l1 mm	l2 mm	EDP #
	Fract. inch	Wire / letter	mm				
0.5469	35/64		13.890	14.000	182.00	133.00	9055120138900
0.5512			14.000	14.000	182.00	133.00	9055120140000
0.5551			14.100	16.000	204.00	152.00	9055120141000
0.5591			14.200	16.000	204.00	152.00	9055120142000
0.5626	9/16		14.290	16.000	204.00	152.00	9055120142900
0.5709			14.500	16.000	204.00	152.00	9055120145000
0.5906			15.000	16.000	204.00	152.00	9055120150000
0.5945			15.100	16.000	204.00	152.00	9055120151000
0.6094	39/64		15.480	16.000	204.00	152.00	9055120154800
0.6102			15.500	16.000	204.00	152.00	9055120155000
0.6248	5/8		15.870	16.000	204.00	152.00	9055120158700
0.6299			16.000	16.000	204.00	152.00	9055120160000
0.6496			16.500	18.000	223.00	171.00	9055120165000
0.6563	21/32		16.670	18.000	223.00	171.00	9055120166700
0.6654			16.900	18.000	223.00	171.00	9055120169000
0.6693			17.000	18.000	223.00	171.00	9055120170000
0.6890			17.500	18.000	223.00	171.00	9055120175000
0.7087			18.000	18.000	223.00	171.00	9055120180000
0.7283			18.500	20.000	244.00	190.00	9055120185000
0.7441			18.900	20.000	244.00	190.00	9055120189000
0.7480			19.000	20.000	244.00	190.00	9055120190000
0.7500	3/4		19.050	20.000	244.00	190.00	9055120190500
0.7677			19.500	20.000	244.00	190.00	9055120195000
0.7874			20.000	20.000	244.00	190.00	9055120200000

Alternative Drill Series:
#5612 Carbide, RT100, 7xD, 140 U pt, FIREX®
#4044 Carbide, RT100U, 7xD, 140 X pt, nano-FIREX®

10xD



Bright finish

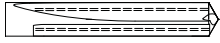

Coolant Through



Reinforced Straight Shank

Speeds & Feeds
information pg 482

Series 5513

RT 150 GG

Carbide, RT 150 GG straight flute high penetration, 10xD,
120° point, reinforced straight shank, RH cut

Cut Dia. = m7 tolerance range, Shank Dia. = h6

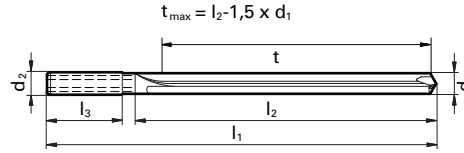

Application Materials:



Aluminum & Alloys



Cast Iron

Twist Drills

Dec. inch	Diameter (d1)			d2 mm	l1 mm	l2 mm	EDP #
	Fract. inch	Wire / letter	mm				
0.1181			3.000	6.000	91.00	42.00	9055130030000
0.1220			3.100	6.000	91.00	42.00	9055130031000
0.1248	1/8		3.170	6.000	91.00	42.00	9055130031700
0.1260			3.200	6.000	91.00	42.00	9055130032000
0.1280			3.250	6.000	91.00	42.00	9055130032500
0.1299			3.300	6.000	91.00	42.00	9055130033000
0.1339			3.400	6.000	91.00	48.00	9055130034000
0.1378			3.500	6.000	91.00	48.00	9055130035000
0.1406	9/64	28	3.570	6.000	91.00	48.00	9055130035700
0.1417			3.600	6.000	91.00	48.00	9055130036000
0.1457		25	3.700	6.000	121.00	77.00	9055130037000
0.1496		25	3.800	6.000	121.00	77.00	9055130038000
0.1535			3.900	6.000	121.00	77.00	9055130039000
0.1563	5/32		3.970	6.000	121.00	77.00	9055130039700
0.1575			4.000	6.000	121.00	77.00	9055130040000
0.1654			4.200	6.000	121.00	77.00	9055130042000
0.1772		16	4.500	6.000	121.00	77.00	9055130045000
0.1969			5.000	6.000	121.00	82.00	9055130050000
0.2165			5.500	6.000	121.00	82.00	9055130055000
0.2362			6.000	6.000	121.00	82.00	9055130060000
0.2500	1/4	E	6.350	8.000	146.00	106.00	9055130063500
0.2559			6.500	8.000	146.00	106.00	9055130065000
0.2677			6.800	8.000	146.00	106.00	9055130068000
0.2756			7.000	8.000	146.00	106.00	9055130070000
0.2953			7.500	8.000	146.00	106.00	9055130075000
0.3071			7.800	8.000	146.00	106.00	9055130078000

Dec. inch	Diameter (d1)			d2 mm	l1 mm	l2 mm	EDP #
	Fract. inch	Wire / letter	mm				
0.3150			8.000	8.000	146.00	106.00	9055130080000
0.3346			8.500	10.000	175.00	130.00	9055130085000
0.3543			9.000	10.000	175.00	130.00	9055130090000
0.3740			9.500	10.000	175.00	130.00	9055130095000
0.3748	3/8		9.520	10.000	175.00	130.00	9055130095200
0.3937			10.000	10.000	175.00	130.00	9055130100000
0.4016			10.200	12.000	209.00	159.00	9055130102000
0.4134			10.500	12.000	209.00	159.00	9055130105000
0.4331			11.000	12.000	209.00	159.00	9055130110000
0.4528			11.500	12.000	209.00	159.00	9055130115000
0.4724			12.000	12.000	209.00	159.00	9055130120000
0.4921			12.500	14.000	233.00	183.00	9055130125000
0.5000	1/2		12.700	14.000	233.00	183.00	9055130127000
0.5118			13.000	14.000	233.00	183.00	9055130130000
0.5315			13.500	14.000	233.00	183.00	9055130135000
0.5512			14.000	14.000	233.00	183.00	9055130140000
0.5709			14.500	16.000	260.00	207.00	9055130145000
0.5906			15.000	16.000	260.00	207.00	9055130150000
0.6102			15.500	16.000	260.00	207.00	9055130155000
0.6299			16.000	16.000	260.00	207.00	9055130160000

Alternative Drill Series:

#770 Carbide, RT150GG, 10xD, 120 pt, Bright
#6070 K20 Carb, RT150GG, 10xD, 130 pt, Bright

*Items listed in red are non-stocked items, and may take 2 - 6 weeks to receive

3xD

Series 5514

Application Materials:

Twist Drills



FIREX® coated



External Coolant



Reinforced Straight Shank

Speeds & Feeds
information pg 483

RT 100 U High Penetration

Carbide, RT 100 U high penetration, 3xD, self-centering
140° SU point, reinforced straight shank, RH helix

Cut Dia. = m7 tolerance range, Shank Dia. = h6

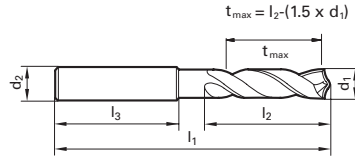

- General Steels/Brass
- Universal Steels
- Stainless Steels
- Hardened Materials
- Cast Iron
- Ti & Ni Alloys



Diameter (d1)		Wire / letter	mm	d2 mm	l1 mm	l2 mm	EDP #
Dec. inch	Fract. inch						
0.1181			3.000	6.000	62.00	20.00	9055140030000
0.1220			3.100	6.000	62.00	20.00	9055140031000
0.1248	1/8		3.170	6.000	62.00	20.00	9055140031700
0.1260			3.200	6.000	62.00	20.00	9055140032000
0.1280			3.250	6.000	62.00	20.00	9055140032500
0.1299			3.300	6.000	62.00	20.00	9055140033000
0.1339			3.400	6.000	62.00	20.00	9055140034000
0.1378			3.500	6.000	62.00	20.00	9055140035000
0.1406	9/64	28	3.570	6.000	62.00	20.00	9055140035700
0.1417			3.600	6.000	62.00	20.00	9055140036000
0.1457			3.700	6.000	62.00	20.00	9055140037000
0.1496		25	3.800	6.000	66.00	24.00	9055140038000
0.1535			3.900	6.000	66.00	24.00	9055140039000
0.1563	5/32		3.970	6.000	66.00	24.00	9055140039700
0.1575			4.000	6.000	66.00	24.00	9055140040000
0.1591		21	4.040	6.000	66.00	24.00	9055140040400
0.1614			4.100	6.000	66.00	24.00	9055140041000
0.1654			4.200	6.000	66.00	24.00	9055140042000
0.1693		18	4.300	6.000	66.00	24.00	9055140043000
0.1720	11/64		4.370	6.000	66.00	24.00	9055140043700
0.1732			4.400	6.000	66.00	24.00	9055140044000
0.1772		16	4.500	6.000	66.00	24.00	9055140045000
0.1811			4.600	6.000	66.00	24.00	9055140046000
0.1831			4.650	6.000	66.00	24.00	9055140046500
0.1850		13	4.700	6.000	66.00	24.00	9055140047000
0.1874	3/16		4.760	6.000	66.00	28.00	9055140047600
0.1890		12	4.800	6.000	66.00	28.00	9055140048000
0.1929			4.900	6.000	66.00	28.00	9055140049000
0.1969			5.000	6.000	66.00	28.00	9055140050000
0.2008			5.100	6.000	66.00	28.00	9055140051000
0.2012		7	5.110	6.000	66.00	28.00	9055140051100
0.2031	13/64		5.160	6.000	66.00	28.00	9055140051600
0.2047			5.200	6.000	66.00	28.00	9055140052000
0.2067			5.250	6.000	66.00	28.00	9055140052500
0.2087			5.300	6.000	66.00	28.00	9055140053000
0.2126			5.400	6.000	66.00	28.00	9055140054000
0.2130		3	5.410	6.000	66.00	28.00	9055140054100
0.2165			5.500	6.000	66.00	28.00	9055140055000
0.2185			5.550	6.000	66.00	28.00	9055140055500
0.2189	7/32		5.560	6.000	66.00	28.00	9055140055600
0.2205			5.600	6.000	66.00	28.00	9055140056000
0.2244			5.700	6.000	66.00	28.00	9055140057000
0.2283			5.800	6.000	66.00	28.00	9055140058000
0.2323			5.900	6.000	66.00	28.00	9055140059000
0.2343	15/64		5.950	6.000	66.00	28.00	9055140059500
0.2362			6.000	6.000	66.00	28.00	9055140060000
0.2402			6.100	8.000	79.00	34.00	9055140061000
0.2441			6.200	8.000	79.00	34.00	9055140062000
0.2480			6.300	8.000	79.00	34.00	9055140063000
0.2500	1/4	E	6.350	8.000	79.00	34.00	9055140063500

Diameter (d1)		Wire / letter	mm	d2 mm	l1 mm	l2 mm	EDP #
Dec. inch	Fract. inch						
0.2520			6.400	8.000	79.00	34.00	9055140064000
0.2559			6.500	8.000	79.00	34.00	9055140065000
0.2571		F	6.530	8.000	79.00	34.00	9055140065300
0.2598			6.600	8.000	79.00	34.00	9055140066000
0.2638			6.700	8.000	79.00	34.00	9055140067000
0.2657	17/64	H	6.750	8.000	79.00	34.00	9055140067500
0.2677			6.800	8.000	79.00	34.00	9055140068000
0.2717		I	6.900	8.000	79.00	34.00	9055140069000
0.2756			7.000	8.000	79.00	34.00	9055140070000
0.2795			7.100	8.000	79.00	34.00	9055140071000
0.2811	9/32	K	7.140	8.000	79.00	41.00	9055140071400
0.2835			7.200	8.000	79.00	41.00	9055140072000
0.2874			7.300	8.000	79.00	41.00	9055140073000
0.2913			7.400	8.000	79.00	41.00	9055140074000
0.2953			7.500	8.000	79.00	41.00	9055140075000
0.2969	19/64		7.540	8.000	79.00	41.00	9055140075400
0.2992			7.600	8.000	79.00	41.00	9055140076000
0.3031			7.700	8.000	79.00	41.00	9055140077000
0.3071			7.800	8.000	79.00	41.00	9055140078000
0.3110			7.900	8.000	79.00	41.00	9055140079000
0.3126	5/16		7.940	8.000	79.00	41.00	9055140079400
0.3150			8.000	8.000	79.00	41.00	9055140080000
0.3189			8.100	10.000	89.00	47.00	9055140081000
0.3228		P	8.200	10.000	89.00	47.00	9055140082000
0.3268			8.300	10.000	89.00	47.00	9055140083000
0.3280	21/64		8.330	10.000	89.00	47.00	9055140083300
0.3307			8.400	10.000	89.00	47.00	9055140084000
0.3346			8.500	10.000	89.00	47.00	9055140085000
0.3386			8.600	10.000	89.00	47.00	9055140086000
0.3425			8.700	10.000	89.00	47.00	9055140087000
0.3437	11/32		8.730	10.000	89.00	47.00	9055140087300
0.3465			8.800	10.000	89.00	47.00	9055140088000
0.3504			8.900	10.000	89.00	47.00	9055140089000
0.3543			9.000	10.000	89.00	47.00	9055140090000
0.3583			9.100	10.000	89.00	47.00	9055140091000
0.3594	23/64		9.130	10.000	89.00	47.00	9055140091300
0.3622			9.200	10.000	89.00	47.00	9055140092000
0.3642			9.250	10.000	89.00	47.00	9055140092500
0.3661			9.300	10.000	89.00	47.00	9055140093000
0.3677		U	9.340	10.000	89.00	47.00	9055140093400
0.3701			9.400	10.000	89.00	47.00	9055140094000
0.3740			9.500	10.000	89.00	47.00	9055140095000
0.3748	3/8		9.520	10.000	89.00	47.00	9055140095200
0.3780			9.600	10.000	89.00	47.00	9055140096000
0.3819			9.700	10.000	89.00	47.00	9055140097000
0.3858		W	9.800	10.000	89.00	47.00	9055140098000
0.3898			9.900	10.000	89.00	47.00	9055140099000
0.3906	25/64		9.920	10.000	89.00	47.00	9055140099200
0.3937			10.000	10.000	89.00	47.00	9055140100000
0.3976			10.100	12.000	102.00	55.00	9055140101000

Series 5514

Speeds & Feeds information pg 483

Diameter (d1)		d2 mm	l1 mm	l2 mm	EDP #	
Dec. inch	Fract. inch					
0.4016		10.200	12.000	102.00	55.00	9055140102000
0.4055		10.300	12.000	102.00	55.00	9055140103000
0.4063	13/32	10.320	12.000	102.00	55.00	9055140103200
0.4094		10.400	12.000	102.00	55.00	9055140104000
0.4134		10.500	12.000	102.00	55.00	9055140105000
0.4173		10.600	12.000	102.00	55.00	9055140106000
0.4213		10.700	12.000	102.00	55.00	9055140107000
0.4220	27/64	10.720	12.000	102.00	55.00	9055140107200
0.4252		10.800	12.000	102.00	55.00	9055140108000
0.4291		10.900	12.000	102.00	55.00	9055140109000
0.4331		11.000	12.000	102.00	55.00	9055140110000
0.4370		11.100	12.000	102.00	55.00	9055140111000
0.4374	7/16	11.110	12.000	102.00	55.00	9055140111100
0.4409		11.200	12.000	102.00	55.00	9055140112000
0.4449		11.300	12.000	102.00	55.00	9055140113000
0.4488		11.400	12.000	102.00	55.00	9055140114000
0.4528		11.500	12.000	102.00	55.00	9055140115000
0.4531	29/64	11.510	12.000	102.00	55.00	9055140115100
0.4567		11.600	12.000	102.00	55.00	9055140116000
0.4606		11.700	12.000	102.00	55.00	9055140117000
0.4646		11.800	12.000	102.00	55.00	9055140118000
0.4685		11.900	12.000	102.00	55.00	9055140119000
0.4689	15/32	11.910	12.000	102.00	55.00	9055140119100
0.4724		12.000	12.000	102.00	55.00	9055140120000
0.4764		12.100	14.000	107.00	60.00	9055140121000
0.4803		12.200	14.000	107.00	60.00	9055140122000
0.4843	31/64	12.300	14.000	107.00	60.00	9055140123000
0.4882		12.400	14.000	107.00	60.00	9055140124000
0.4921		12.500	14.000	107.00	60.00	9055140125000
0.4961		12.600	14.000	107.00	60.00	9055140126000
0.5000	1/2	12.700	14.000	107.00	60.00	9055140127000
0.5039		12.800	14.000	107.00	60.00	9055140128000
0.5079		12.900	14.000	107.00	60.00	9055140129000
0.5118		13.000	14.000	107.00	60.00	9055140130000
0.5157	33/64	13.100	14.000	107.00	60.00	9055140131000
0.5197		13.200	14.000	107.00	60.00	9055140132000
0.5236		13.300	14.000	107.00	60.00	9055140133000
0.5276		13.400	14.000	107.00	60.00	9055140134000
0.5311	17/32	13.490	14.000	107.00	60.00	9055140134900
0.5315		13.500	14.000	107.00	60.00	9055140135000
0.5354		13.600	14.000	107.00	60.00	9055140136000
0.5394		13.700	14.000	107.00	60.00	9055140137000
0.5433		13.800	14.000	107.00	60.00	9055140138000
0.5469	35/64	13.890	14.000	107.00	60.00	9055140138900
0.5472		13.900	14.000	107.00	60.00	9055140139000
0.5512		14.000	14.000	107.00	60.00	9055140140000
0.5551		14.100	16.000	115.00	65.00	9055140141000

Diameter (d1)		d2 mm	l1 mm	l2 mm	EDP #	
Dec. inch	Fract. inch					
0.5591		14.200	16.000	115.00	65.00	9055140142000
0.5626	9/16	14.290	16.000	107.00	60.00	9055140142900
0.5630		14.300	16.000	115.00	65.00	9055140143000
0.5669		14.400	16.000	115.00	65.00	9055140144000
0.5709		14.500	16.000	115.00	65.00	9055140145000
0.5748		14.600	16.000	115.00	65.00	9055140146000
0.5780	37/64	14.680	16.000	115.00	65.00	9055140146800
0.5787		14.700	16.000	115.00	65.00	9055140147000
0.5827		14.800	16.000	115.00	65.00	9055140148000
0.5866		14.900	16.000	115.00	65.00	9055140149000
0.5906		15.000	16.000	115.00	65.00	9055140150000
0.5937	19/32	15.080	16.000	115.00	65.00	9055140150800
0.5945		15.100	16.000	115.00	65.00	9055140151000
0.5984		15.200	16.000	115.00	65.00	9055140152000
0.6024		15.300	16.000	115.00	65.00	9055140153000
0.6063		15.400	16.000	115.00	65.00	9055140154000
0.6094	39/64	15.480	16.000	115.00	65.00	9055140154800
0.6102		15.500	16.000	115.00	65.00	9055140155000
0.6142		15.600	16.000	115.00	65.00	9055140156000
0.6181		15.700	16.000	115.00	65.00	9055140157000
0.6220		15.800	16.000	115.00	65.00	9055140158000
0.6248	5/8	15.870	16.000	115.00	65.00	9055140158700
0.6260		15.900	16.000	115.00	65.00	9055140159000
0.6299		16.000	16.000	115.00	65.00	9055140160000
0.6406	41/64	16.270	18.000	123.00	73.00	9055140162700
0.6496		16.500	18.000	123.00	73.00	9055140165000
0.6563	21/32	16.670	18.000	123.00	73.00	9055140166700
0.6693		17.000	18.000	123.00	73.00	9055140170000
0.6720	43/64	17.070	18.000	123.00	73.00	9055140170700
0.6874	11/16	17.460	18.000	123.00	73.00	9055140174600
0.6890		17.500	18.000	123.00	73.00	9055140175000
0.7031	45/64	17.860	18.000	123.00	73.00	9055140178600
0.7087		18.000	18.000	123.00	73.00	9055140180000
0.7189	23/32	18.260	20.000	131.00	79.00	9055140182600
0.7283		18.500	20.000	131.00	79.00	9055140185000
0.7480		19.000	20.000	131.00	79.00	9055140190000
0.7500	3/4	19.050	20.000	131.00	79.00	9055140190500
0.7579		19.250	20.000	131.00	79.00	9055140192500
0.7656	49/64	19.446	20.000	131.00	79.00	9055140194460
0.7677		19.500	20.000	131.00	79.00	9055140195000
0.7811	25/32	19.840	20.000	131.00	79.00	9055140198400
0.7874		20.000	20.000	131.00	79.00	9055140200000

Alternative Drill Series:

- #1242 Carbide, RT100, 3xD, 140 U pt, TiN
- #1702 Carbide, RT100, 3xD, 140 F pt, TiN

*Items listed in red are non-stocked items, and may take 2 - 6 weeks to receive

5xD

Series 5515

Application Materials:



FIRESX® coated



External Coolant

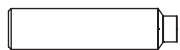

Reinforced Straight Shank

Speeds & Feeds
information pg 483

RT 100 U High Penetration

Carbide, RT 100 U high penetration, 5xD, self-centering
140° SU point, reinforced straight shank, RH helix

Cut Dia. = m7 tolerance range, Shank Dia. = h6

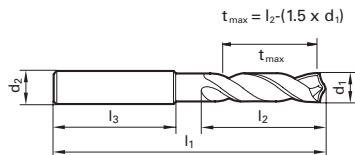

- General Steels/Brass
- Universal Steels
- Stainless Steels
- Hardened Materials
- Cast Iron
- Ti & Ni Alloys



Dec. inch	Diameter (d1)		d2 mm	l1 mm	l2 mm	EDP #	
	Fract. inch	Wire / letter					
0.1181			3.000	6.000	66.00	28.00	9055150030000
0.1220			3.100	6.000	66.00	28.00	9055150031000
0.1248	1/8		3.170	6.000	66.00	28.00	9055150031700
0.1260			3.200	6.000	66.00	28.00	9055150032000
0.1280			3.250	6.000	66.00	28.00	9055150032500
0.1299			3.300	6.000	66.00	28.00	9055150033000
0.1339			3.400	6.000	66.00	28.00	9055150034000
0.1378			3.500	6.000	66.00	28.00	9055150035000
0.1406	9/64	28	3.570	6.000	66.00	28.00	9055150035700
0.1417			3.600	6.000	66.00	28.00	9055150036000
0.1457			3.700	6.000	66.00	28.00	9055150037000
0.1496		25	3.800	6.000	74.00	36.00	9055150038000
0.1535			3.900	6.000	74.00	36.00	9055150039000
0.1563	5/32		3.970	6.000	74.00	36.00	9055150039700
0.1575			4.000	6.000	74.00	36.00	9055150040000
0.1614			4.100	6.000	74.00	36.00	9055150041000
0.1654			4.200	6.000	74.00	36.00	9055150042000
0.1693			4.300	6.000	74.00	36.00	9055150043000
0.1720	11/64		4.370	6.000	74.00	36.00	9055150043700
0.1732			4.400	6.000	74.00	36.00	9055150044000
0.1772		16	4.500	6.000	74.00	36.00	9055150045000
0.1811			4.600	6.000	74.00	36.00	9055150046000
0.1831			4.650	6.000	74.01	36.01	9055150046500
0.1850			4.700	6.000	74.00	36.00	9055150047000
0.1874	3/16		4.760	6.000	82.00	44.00	9055150047600
0.1890		12	4.800	6.000	82.00	44.00	9055150048000
0.1929			4.900	6.000	82.00	44.00	9055150049000
0.1969			5.000	6.000	82.00	44.00	9055150050000
0.2008			5.100	6.000	82.00	44.00	9055150051000
0.2031	13/64		5.160	6.000	82.00	44.00	9055150051600
0.2047			5.200	6.000	82.00	44.00	9055150052000
0.2067			5.250	6.000	82.00	44.00	9055150052500
0.2087			5.300	6.000	82.00	44.00	9055150053000
0.2126			5.400	6.000	82.00	44.00	9055150054000
0.2165			5.500	6.000	82.00	44.00	9055150055000
0.2185			5.550	6.000	82.00	44.00	9055150055500
0.2189	7/32		5.560	6.000	82.00	44.00	9055150055600
0.2205			5.600	6.000	82.00	44.00	9055150056000
0.2244			5.700	6.000	82.00	44.00	9055150057000
0.2283			5.800	6.000	82.00	44.00	9055150058000
0.2323			5.900	6.000	82.00	44.00	9055150059000
0.2343	15/64		5.950	6.000	82.00	44.00	9055150059500
0.2362			6.000	6.000	82.00	44.00	9055150060000
0.2402			6.100	8.000	91.00	53.00	9055150061000
0.2441			6.200	8.000	91.00	53.00	9055150062000
0.2480			6.300	8.000	91.00	53.00	9055150063000
0.2500	1/4	E	6.350	8.000	91.00	53.00	9055150063500
0.2520			6.400	8.000	91.00	53.00	9055150064000

Dec. inch	Diameter (d1)		d2 mm	l1 mm	l2 mm	EDP #	
	Fract. inch	Wire / letter					
0.2559			6.500	8.000	91.00	53.00	9055150065000
0.2598			6.600	8.000	91.00	53.00	9055150066000
0.2638			6.700	8.000	91.00	53.00	9055150067000
0.2657	17/64	H	6.750	8.000	91.00	53.00	9055150067500
0.2677			6.800	8.000	91.00	53.00	9055150068000
0.2717		I	6.900	8.000	91.00	53.00	9055150069000
0.2756			7.000	8.000	91.00	53.00	9055150070000
0.2795			7.100	8.000	91.00	53.00	9055150071000
0.2811	9/32	K	7.140	8.000	91.00	53.00	9055150071400
0.2835			7.200	8.000	91.00	53.00	9055150072000
0.2874			7.300	8.000	91.00	53.00	9055150073000
0.2913			7.400	8.000	91.00	53.00	9055150074000
0.2953			7.500	8.000	91.00	53.00	9055150075000
0.2969	19/64		7.540	8.000	91.00	53.00	9055150075400
0.2992			7.600	8.000	91.00	53.00	9055150076000
0.3031			7.700	8.000	91.00	53.00	9055150077000
0.3071			7.800	8.000	91.00	53.00	9055150078000
0.3110			7.900	8.000	91.00	53.00	9055150079000
0.3126	5/16		7.940	8.000	91.00	53.00	9055150079400
0.3150			8.000	8.000	91.00	53.00	9055150080000
0.3189			8.100	10.000	103.00	61.00	9055150081000
0.3228		P	8.200	10.000	103.00	61.00	9055150082000
0.3268			8.300	10.000	103.00	61.00	9055150083000
0.3280	21/64		8.330	10.000	103.00	61.00	9055150083300
0.3307			8.400	10.000	103.00	61.00	9055150084000
0.3346			8.500	10.000	103.00	61.00	9055150085000
0.3386			8.600	10.000	103.00	61.00	9055150086000
0.3425			8.700	10.000	103.00	61.00	9055150087000
0.3437	11/32		8.730	10.000	103.00	61.00	9055150087300
0.3465			8.800	10.000	103.00	61.00	9055150088000
0.3504			8.900	10.000	103.00	61.00	9055150089000
0.3543			9.000	10.000	103.00	61.00	9055150090000
0.3583			9.100	10.000	103.00	61.00	9055150091000
0.3594	23/64		9.130	10.000	103.00	61.00	9055150091300
0.3622			9.200	10.000	103.00	61.00	9055150092000
0.3642			9.250	10.000	103.00	61.00	9055150092500
0.3661			9.300	10.000	103.00	61.00	9055150093000
0.3701			9.400	10.000	103.00	61.00	9055150094000
0.3740			9.500	10.000	103.00	61.00	9055150095000
0.3748	3/8		9.520	10.000	103.00	61.00	9055150095200
0.3780			9.600	10.000	103.00	61.00	9055150096000
0.3819			9.700	10.000	103.00	61.00	9055150097000
0.3858		W	9.800	10.000	103.00	61.00	9055150098000
0.3898			9.900	10.000	103.00	61.00	9055150099000
0.3906	25/64		9.920	10.000	103.00	61.00	9055150099200
0.3937			10.000	10.000	103.00	61.00	9055150100000
0.3976			10.100	12.000	118.00	71.00	9055150101000
0.4016			10.200	12.000	118.00	71.00	9055150102000

Series 5515

Speeds & Feeds information pg 483

Diameter (d1)							
Dec. inch	Fract. inch	Wire / letter	mm	d2 mm	l1 mm	l2 mm	EDP #
0.4055			10.300	12.000	118.00	71.00	9055150103000
0.4063	13/32		10.320	12.000	118.00	71.00	9055150103200
0.4094			10.400	12.000	118.00	71.00	9055150104000
0.4134			10.500	12.000	118.00	71.00	9055150105000
0.4173			10.600	12.000	118.00	71.00	9055150106000
0.4213			10.700	12.000	118.00	71.00	9055150107000
0.4220	27/64		10.720	12.000	118.00	71.00	9055150107200
0.4252			10.800	12.000	118.00	71.00	9055150108000
0.4291			10.900	12.000	118.00	71.00	9055150109000
0.4331			11.000	12.000	118.00	71.00	9055150110000
0.4370			11.100	12.000	118.00	71.00	9055150111000
0.4374	7/16		11.110	12.000	118.00	71.00	9055150111100
0.4409			11.200	12.000	118.00	71.00	9055150112000
0.4449			11.300	12.000	118.00	71.00	9055150113000
0.4488			11.400	12.000	118.00	71.00	9055150114000
0.4528			11.500	12.000	118.00	71.00	9055150115000
0.4567			11.600	12.000	118.00	71.00	9055150116000
0.4606			11.700	12.000	118.00	71.00	9055150117000
0.4646			11.800	12.000	118.00	71.00	9055150118000
0.4685			11.900	12.000	118.00	71.00	9055150119000
0.4689	15/32		11.910	12.000	118.00	71.00	9055150119100
0.4724			12.000	12.000	118.00	71.00	9055150120000
0.4764			12.100	14.000	124.00	77.00	9055150121000
0.4803			12.200	14.000	124.00	77.00	9055150122000
0.4843	31/64		12.300	14.000	124.00	77.00	9055150123000
0.4882			12.400	14.000	124.00	77.00	9055150124000
0.4921			12.500	14.000	124.00	77.00	9055150125000
0.4961			12.600	14.000	124.00	77.00	9055150126000
0.5000	1/2		12.700	14.000	124.00	77.00	9055150127000
0.5118			13.000	14.000	124.00	77.00	9055150130000
0.5157	33/64		13.100	14.000	124.00	77.00	9055150131000
0.5197			13.200	14.000	124.00	77.00	9055150132000
0.5236			13.300	14.000	124.00	77.00	9055150133000
0.5315			13.500	14.000	124.00	77.00	9055150135000

Diameter (d1)							
Dec. inch	Fract. inch	Wire / letter	mm	d2 mm	l1 mm	l2 mm	EDP #
0.5394			13.700	14.000	124.00	77.00	9055150137000
0.5433			13.800	14.000	124.00	77.00	9055150138000
0.5512			14.000	14.000	124.00	77.00	9055150140000
0.5551			14.100	16.000	133.00	83.00	9055150141000
0.5591			14.200	16.000	133.00	83.00	9055150142000
0.5626	9/16		14.290	16.000	133.00	83.00	9055150142900
0.5630			14.300	16.000	133.00	83.00	9055150143000
0.5669			14.400	16.000	133.00	83.00	9055150144000
0.5709			14.500	16.000	133.00	83.00	9055150145000
0.5787			14.700	16.000	133.00	83.00	9055150147000
0.5906			15.000	16.000	133.00	83.00	9055150150000
0.5945			15.100	16.000	133.00	83.00	9055150151000
0.5984			15.200	16.000	133.00	83.00	9055150152000
0.6102			15.500	16.000	133.00	83.00	9055150155000
0.6142			15.600	16.000	133.00	83.00	9055150156000
0.6181			15.700	16.000	133.00	83.00	9055150157000
0.6220			15.800	16.000	133.00	83.00	9055150158000
0.6248	5/8		15.870	16.000	133.00	83.00	9055150158700
0.6299			16.000	16.000	133.00	83.00	9055150160000
0.6496			16.500	18.000	143.00	93.00	9055150165000
0.6693			17.000	18.000	143.00	93.00	9055150170000
0.6890			17.500	18.000	143.00	93.00	9055150175000
0.7087			18.000	18.000	143.00	93.00	9055150180000
0.7283			18.500	20.000	153.00	101.00	9055150185000
0.7480			19.000	20.000	153.00	101.00	9055150190000
0.7677			19.500	20.000	153.00	101.00	9055150195000
0.7874			20.000	20.000	153.00	101.00	9055150200000

Alternative Drill Series:
#1243 Carbide, RT100, 5xD, 140 U pt, TiN
#1662 Carbide, RT100, 5xD, 140 F pt, TiN
#5511 Carbide, RT100, 5xD, 140 U pt, FIREX®

*Items listed in red are non-stocked items, and may take 2 - 6 weeks to receive

5xD



Bright Finish



External Coolant



Reinforced Straight Shank

Speeds & Feeds
information pg 484

Series 5518

Three-Flute High Precision

Carbide, GS 200 G three-flute high precision, 5xD, self-centering 130° point, reinforced straight shank, RH helix

Cut Dia. = m7 tolerance range, Shank Dia. = h6

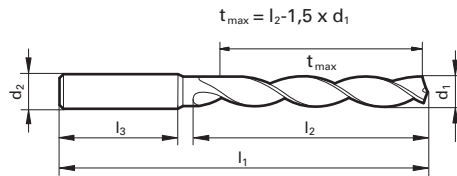

Application Materials:

- General Steels/Brass
- Cast Iron
- Aluminum & Alloys



Diameter (d1)		Wire / letter	d2 mm	l1 mm	l2 mm	EDP #
Dec. inch	Fract. inch					
0.1181			3.000	66.00	28.00	9055180030000
0.1220			3.100	66.00	28.00	9055180031000
0.1260			3.200	66.00	28.00	9055180032000
0.1299			3.300	66.00	28.00	9055180033000
0.1378			3.500	66.00	28.00	9055180035000
0.1457			3.700	66.00	28.00	9055180037000
0.1496		25	3.800	74.00	36.00	9055180038000
0.1575			4.000	74.00	36.00	9055180040000
0.1614			4.100	74.00	36.00	9055180041000
0.1654			4.200	74.00	36.00	9055180042000
0.1772		16	4.500	74.00	36.00	9055180045000
0.1890		12	4.800	74.00	36.00	9055180048000
0.1969			5.000	82.00	44.00	9055180050000
0.2008			5.100	82.00	44.00	9055180051000
0.2047			5.200	82.00	44.00	9055180052000
0.2087			5.300	82.00	44.00	9055180053000
0.2165			5.500	82.00	44.00	9055180055000
0.2283			5.800	82.00	44.00	9055180058000
0.2362			6.000	82.00	44.00	9055180060000
0.2402			6.100	91.00	53.00	9055180061000
0.2441			6.200	91.00	53.00	9055180062000
0.2520			6.400	91.00	53.00	9055180064000
0.2559			6.500	91.00	53.00	9055180065000
0.2638			6.700	91.00	53.00	9055180067000
0.2677			6.800	91.00	53.00	9055180068000
0.2717			6.900	91.00	53.00	9055180069000
0.2756			7.000	91.00	53.00	9055180070000
0.2795			7.100	91.00	53.00	9055180071000
0.2913			7.400	91.00	53.00	9055180074000
0.2953			7.500	91.00	53.00	9055180075000
0.3071			7.800	91.00	53.00	9055180078000
0.3150			8.000	91.00	53.00	9055180080000
0.3189			8.100	103.00	61.00	9055180081000
0.3228		P	8.200	103.00	61.00	9055180082000
0.3307			8.400	103.00	61.00	9055180084000
0.3346			8.500	103.00	61.00	9055180085000
0.3386			8.600	103.00	61.00	9055180086000
0.3425			8.700	103.00	61.00	9055180087000

Diameter (d1)		Wire / letter	d2 mm	l1 mm	l2 mm	EDP #
Dec. inch	Fract. inch					
0.3465			8.800	103.00	61.00	9055180088000
0.3543			9.000	103.00	61.00	9055180090000
0.3583			9.100	103.00	61.00	9055180091000
0.3740			9.500	103.00	61.00	9055180095000
0.3858		W	9.800	103.00	61.00	9055180098000
0.3937			10.000	103.00	61.00	9055180100000
0.3976			10.100	118.00	71.00	9055180101000
0.4016			10.200	118.00	71.00	9055180102000
0.4055			10.300	118.00	71.00	9055180103000
0.4134			10.500	118.00	71.00	9055180105000
0.4331			11.000	118.00	71.00	9055180110000
0.4409			11.200	118.00	71.00	9055180112000
0.4528			11.500	118.00	71.00	9055180115000
0.4646			11.800	118.00	71.00	9055180118000
0.4724			12.000	118.00	71.00	9055180120000
0.4764			12.100	124.00	77.00	9055180121000
0.4921			12.500	124.00	77.00	9055180125000
0.5118			13.000	124.00	77.00	9055180130000
0.5315			13.500	124.00	77.00	9055180135000
0.5512			14.000	124.00	77.00	9055180140000
0.5709			14.500	133.00	83.00	9055180145000
0.5906			15.000	133.00	83.00	9055180150000
0.6102			15.500	133.00	83.00	9055180155000
0.6299			16.000	133.00	83.00	9055180160000
0.6496			16.500	143.00	93.00	9055180165000
0.6693			17.000	143.00	93.00	9055180170000
0.6890			17.500	143.00	93.00	9055180175000
0.7087			18.000	143.00	93.00	9055180180000
0.7283			18.500	153.00	101.00	9055180185000
0.7480			19.000	153.00	101.00	9055180190000
0.7677			19.500	153.00	101.00	9055180195000
0.7874			20.000	153.00	101.00	9055180200000

Alternative Drill Series:

- #609 Carbide, GS200, 5xD, 150 U pt, TiN
- #1452 Carbide, GS200, 5xD, 150 U pt, Bright

5xD



TiN coated



External Coolant



Straight Shank

Speeds & Feeds
information pg 484

Series 5519

GU 500 DZ High-Performance

Cobalt, GU 500 DZ universal, jobber length, 118° 4-facet split point, standard straight shank, RH helix

Cut/Shank Dia. = h8 tolerance range

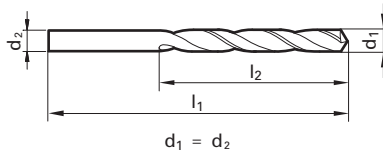

Application Materials:

- General Steels/Brass
- Universal Steels
- Stainless Steels
- Hardened Materials
- Cast Iron



Twist Drills

Dec. inch	Diameter (d1)		l1 mm	l2 mm	EDP #
	Fract. inch	Wire / letter			
0.0394			34.00	12.00	9055190010000
0.0402		60	34.00	12.00	9055190010200
0.0409		59	34.00	12.00	9055190010400
0.0421		58	36.00	14.00	9055190010700
0.0429		57	36.00	14.00	9055190010900
0.0433			36.00	14.00	9055190011000
0.0465		56	36.00	14.00	9055190011800
0.0469	3/64		38.00	16.00	9055190011900
0.0472			38.00	16.00	9055190012000
0.0512			38.00	16.00	9055190013000
0.0520		55	38.00	16.00	9055190013200
0.0551		54	40.00	18.00	9055190014000
0.0591			40.00	18.00	9055190015000
0.0594		53	43.00	20.00	9055190015100
0.0626	1/16		43.00	20.00	9055190015900
0.0630			43.00	20.00	9055190016000
0.0634		52	43.00	20.00	9055190016100
0.0669		51	43.00	20.00	9055190017000
0.0701		50	46.00	22.00	9055190017800
0.0709			46.00	22.00	9055190018000
0.0728		49	46.00	22.00	9055190018500
0.0748			46.00	22.00	9055190019000
0.0760		48	49.00	24.00	9055190019300
0.0780	5/64		49.00	24.00	9055190019800
0.0783		47	49.00	24.00	9055190019900
0.0787			49.00	24.00	9055190020000
0.0811		46	49.00	24.00	9055190020600
0.0819		45	49.00	24.00	9055190020800
0.0827			49.00	24.00	9055190021000
0.0858		44	53.00	27.00	9055190021800
0.0866			53.00	27.00	9055190022000
0.0890		43	53.00	27.00	9055190022600
0.0906			53.00	27.00	9055190023000
0.0933		42	57.00	30.00	9055190023700
0.0937	3/32		57.00	30.00	9055190023800
0.0945			57.00	30.00	9055190024000
0.0961		41	57.00	30.00	9055190024400
0.0980		40	57.00	30.00	9055190024900
0.0984			57.00	30.00	9055190025000
0.0996		39	57.00	30.00	9055190025300
0.1016		38	57.00	30.00	9055190025800
0.1024			57.00	30.00	9055190026000
0.1039		37	57.00	30.00	9055190026400
0.1063			61.00	33.00	9055190027000
0.1067		36	61.00	33.00	9055190027100
0.1094	7/64		61.00	33.00	9055190027800
0.1098		35	61.00	33.00	9055190027900
0.1102			61.00	33.00	9055190028000
0.1110		34	61.00	33.00	9055190028200
0.1130		33	61.00	33.00	9055190028700
0.1142			61.00	33.00	9055190029000
0.1161		32	61.00	33.00	9055190029500
0.1181			61.00	33.00	9055190030000
0.1201		31	65.00	36.00	9055190030500

Dec. inch	Diameter (d1)		l1 mm	l2 mm	EDP #
	Fract. inch	Wire / letter			
0.1220			65.00	36.00	9055190031000
0.1248		1/8	65.00	36.00	9055190031700
0.1260			65.00	36.00	9055190032000
0.1283		30	65.00	36.00	9055190032600
0.1299			65.00	36.00	9055190033000
0.1339			70.00	39.00	9055190034000
0.1358		29	70.00	39.00	9055190034500
0.1378			70.00	39.00	9055190035000
0.1406	9/64		70.00	39.00	9055190035700
0.1417			70.00	39.00	9055190036000
0.1441		27	70.00	39.00	9055190036600
0.1457			70.00	39.00	9055190037000
0.1469		26	70.00	39.00	9055190037300
0.1496		25	75.00	43.00	9055190038000
0.1520		24	75.00	43.00	9055190038600
0.1535			75.00	43.00	9055190039000
0.1539		23	75.00	43.00	9055190039100
0.1563	5/32		75.00	43.00	9055190039700
0.1571		22	75.00	43.00	9055190039900
0.1575			75.00	43.00	9055190040000
0.1591		21	75.00	43.00	9055190040400
0.1610		20	75.00	43.00	9055190040900
0.1614			75.00	43.00	9055190041000
0.1654			75.00	43.00	9055190042000
0.1661		19	75.00	43.00	9055190042200
0.1693		18	80.00	47.00	9055190043000
0.1720	11/64		80.00	47.00	9055190043700
0.1728		17	80.00	47.00	9055190043900
0.1732			80.00	47.00	9055190044000
0.1772		16	80.00	47.00	9055190045000
0.1799		15	80.00	47.00	9055190045700
0.1811			80.00	47.00	9055190046000
0.1819		14	80.00	47.00	9055190046200
0.1850		13	80.00	47.00	9055190047000
0.1874	3/16		86.00	52.00	9055190047600
0.1890		12	86.00	52.00	9055190048000
0.1909		11	86.00	52.00	9055190048500
0.1929			86.00	52.00	9055190049000
0.1937		10	86.00	52.00	9055190049200
0.1961		9	86.00	52.00	9055190049800
0.1969			86.00	52.00	9055190050000
0.1992		8	86.00	52.00	9055190050600
0.2008			86.00	52.00	9055190051000
0.2012		7	86.00	52.00	9055190051100
0.2031	13/64		86.00	52.00	9055190051600
0.2039		6	86.00	52.00	9055190051800
0.2047			86.00	52.00	9055190052000
0.2055		5	86.00	52.00	9055190052200
0.2087			86.00	52.00	9055190053000
0.2091		4	93.00	57.00	9055190053100
0.2126			93.00	57.00	9055190054000
0.2130		3	93.00	57.00	9055190054100
0.2165			93.00	57.00	9055190055000
0.2189	7/32		93.00	57.00	9055190055600

*Items listed in red are non-stocked items, and may take 2 - 6 weeks to receive

Series 5519

Speeds & Feeds information pg 484

Twist Drills

Dec. Inch	Diameter (d1)		l1 mm	l2 mm	EDP #	
	Fract. Inch	Wire / letter				
0.2205			5.600	93.00	57.00	9055190056000
0.2209		2	5.610	93.00	57.00	9055190056100
0.2244			5.700	93.00	57.00	9055190057000
0.2280		1	5.790	93.00	57.00	9055190057900
0.2283			5.800	93.00	57.00	9055190058000
0.2323			5.900	93.00	57.00	9055190059000
0.2339		A	5.940	93.00	57.00	9055190059400
0.2343	15/64		5.950	93.00	57.00	9055190059500
0.2362			6.000	93.00	57.00	9055190060000
0.2378		B	6.040	101.00	63.00	9055190060400
0.2402			6.100	101.00	63.00	9055190061000
0.2421		C	6.150	101.00	63.00	9055190061500
0.2441			6.200	101.00	63.00	9055190062000
0.2461		D	6.250	101.00	63.00	9055190062500
0.2480			6.300	101.00	63.00	9055190063000
0.2500	1/4	E	6.350	101.00	63.00	9055190063500
0.2520			6.400	101.00	63.00	9055190064000
0.2559			6.500	101.00	63.00	9055190065000
0.2571		F	6.530	101.00	63.00	9055190065300
0.2598			6.600	101.00	63.00	9055190066000
0.2610		G	6.630	101.00	63.00	9055190066300
0.2638			6.700	101.00	63.00	9055190067000
0.2657	17/64		6.750	109.00	69.00	9055190067500
0.2677			6.800	109.00	69.00	9055190068000
0.2717		I	6.900	109.00	69.00	9055190069000
0.2756			7.000	109.00	69.00	9055190070000
0.2768		J	7.030	109.00	69.00	9055190070300
0.2795			7.100	109.00	69.00	9055190071000
0.2811	9/32	K	7.140	109.00	69.00	9055190071400
0.2835			7.200	109.00	69.00	9055190072000
0.2874			7.300	109.00	69.00	9055190073000
0.2902		L	7.370	109.00	69.00	9055190073700
0.2913			7.400	109.00	69.00	9055190074000
0.2949		M	7.490	109.00	69.00	9055190074900
0.2953			7.500	109.00	69.00	9055190075000
0.2969	19/64		7.540	117.00	75.00	9055190075400
0.2992			7.600	117.00	75.00	9055190076000
0.3020		N	7.670	117.00	75.00	9055190076700
0.3031			7.700	117.00	75.00	9055190077000
0.3071			7.800	117.00	75.00	9055190078000
0.3110			7.900	117.00	75.00	9055190079000
0.3126	5/16		7.940	117.00	75.00	9055190079400
0.3150			8.000	117.00	75.00	9055190080000
0.3161		O	8.030	117.00	75.00	9055190080300
0.3189			8.100	117.00	75.00	9055190081000
0.3228		P	8.200	117.00	75.00	9055190082000
0.3268			8.300	117.00	75.00	9055190083000
0.3280	21/64		8.330	117.00	75.00	9055190083300
0.3307			8.400	117.00	75.00	9055190084000
0.3319		Q	8.430	117.00	75.00	9055190084300
0.3346			8.500	117.00	75.00	9055190085000
0.3386			8.600	125.00	81.00	9055190086000
0.3390		R	8.610	125.00	81.00	9055190086100
0.3425			8.700	125.00	81.00	9055190087000
0.3437	11/32		8.730	125.00	81.00	9055190087300

Dec. Inch	Diameter (d1)		l1 mm	l2 mm	EDP #	
	Fract. Inch	Wire / letter				
0.3465			8.800	125.00	81.00	9055190088000
0.3480		S	8.840	125.00	81.00	9055190088400
0.3504			8.900	125.00	81.00	9055190089000
0.3543			9.000	125.00	81.00	9055190090000
0.3579		T	9.090	125.00	81.00	9055190090900
0.3583			9.100	125.00	81.00	9055190091000
0.3594	23/64		9.130	125.00	81.00	9055190091300
0.3622			9.200	125.00	81.00	9055190092000
0.3661			9.300	125.00	81.00	9055190093000
0.3677		U	9.340	125.00	81.00	9055190093400
0.3701			9.400	125.00	81.00	9055190094000
0.3740			9.500	125.00	81.00	9055190095000
0.3748	3/8		9.520	133.00	87.00	9055190095200
0.3772		V	9.580	133.00	87.00	9055190095800
0.3780			9.600	133.00	87.00	9055190096000
0.3819			9.700	133.00	87.00	9055190097000
0.3858		W	9.800	133.00	87.00	9055190098000
0.3898			9.900	133.00	87.00	9055190099000
0.3906	25/64		9.920	133.00	87.00	9055190099200
0.3937			10.000	133.00	87.00	9055190100000
0.3969		X	10.080	133.00	87.00	9055190100800
0.3976			10.100	133.00	87.00	9055190101000
0.4016			10.200	133.00	87.00	9055190102000
0.4039		Y	10.260	133.00	87.00	9055190102600
0.4055			10.300	133.00	87.00	9055190103000
0.4063	13/32		10.320	133.00	87.00	9055190103200
0.4094			10.400	133.00	87.00	9055190104000
0.4130		Z	10.490	133.00	87.00	9055190104900
0.4134			10.500	133.00	87.00	9055190105000
0.4220	27/64		10.720	142.00	94.00	9055190107200
0.4331			11.000	142.00	94.00	9055190110000
0.4374	7/16		11.110	142.00	94.00	9055190111100
0.4528			11.500	142.00	94.00	9055190115000
0.4531	29/64		11.510	142.00	94.00	9055190115100
0.4689	15/32		11.910	151.00	101.00	9055190119100
0.4724			12.000	151.00	101.00	9055190120000
0.4843	31/64		12.300	151.00	101.00	9055190123000
0.4921			12.500	151.00	101.00	9055190125000
0.5000	1/2		12.700	151.00	101.00	9055190127000
0.5118			13.000	151.00	101.00	9055190130000
0.5157	33/64		13.100	151.00	101.00	9055190131000
0.5311	17/32		13.490	160.00	108.00	9055190134900
0.5315			13.500	160.00	108.00	9055190135000
0.5512			14.000	160.00	108.00	9055190140000
0.5626	9/16		14.290	169.00	114.00	9055190142900

Alternative Drill Series:

- #5523 Cobalt, GU500, 5xD, 118 pt, Bright
- #657 Cobalt, Ti, 5xD, 130 pt, TiN
- #622 Cobalt, GT100, 5xD, 130 pt, Bright/Nitrided lands > 2.36right
- #530 PM Cobalt, GT500, 5xD, 130 pt, FIREX®

3xD



TiN coated



External Coolant



Straight Shank

Speeds & Feeds
information pg 485

Series 5520

GU 500 DZ High-performance

Cobalt, GU 500 DZ universal, stub length, 118° 4-facet split point, standard straight shank, RH helix

Cut/Shank Dia. = h8 tolerance range

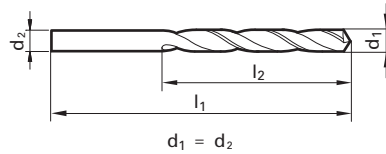

Application Materials:

- General Steels/Brass
- Universal Steels
- Stainless Steels
- Hardened Materials
- Cast Iron



Twist Drills

Diameter (d1)		Wire / letter	l1 mm	l2 mm	EDP #
Dec. inch	Fract. inch				
0.0394			26.00	6.00	9055200010000
0.0402		60	26.00	6.00	9055200010200
0.0409		59	26.00	6.00	9055200010400
0.0421		58	28.00	7.00	9055200010700
0.0429		57	28.00	7.00	9055200010900
0.0433			28.00	7.00	9055200011000
0.0465		56	28.00	7.00	9055200011800
0.0469	3/64		28.00	7.00	9055200011900
0.0472			28.00	7.00	9055200012000
0.0512			28.00	7.00	9055200013000
0.0520		55	28.00	7.00	9055200013200
0.0551		54	32.00	9.00	9055200014000
0.0591			32.00	9.00	9055200015000
0.0594		53	34.00	10.00	9055200015100
0.0626	1/16		34.00	10.00	9055200015900
0.0630			34.00	10.00	9055200016000
0.0634		52	34.00	10.00	9055200016100
0.0669		51	34.00	10.00	9055200017000
0.0701		50	36.00	11.00	9055200017800
0.0709			36.00	11.00	9055200018000
0.0728		49	36.00	11.00	9055200018500
0.0748			36.00	11.00	9055200019000
0.0760		48	38.00	12.00	9055200019300
0.0780	5/64		38.00	12.00	9055200019800
0.0783		47	38.00	12.00	9055200019900
0.0787			38.00	12.00	9055200020000
0.0811		46	38.00	12.00	9055200020600
0.0819		45	38.00	12.00	9055200020800
0.0827			38.00	12.00	9055200021000
0.0858		44	40.00	13.00	9055200021800
0.0866			40.00	13.00	9055200022000
0.0890		43	40.00	13.00	9055200022600
0.0906			40.00	13.00	9055200023000
0.0933		42	43.00	14.00	9055200023700
0.0937	3/32		43.00	14.00	9055200023800
0.0945			43.00	14.00	9055200024000
0.0961		41	43.00	14.00	9055200024400
0.0980		40	43.00	14.00	9055200024900
0.0984			43.00	14.00	9055200025000
0.0996		39	43.00	14.00	9055200025300
0.1016		38	43.00	14.00	9055200025800
0.1024			43.00	14.00	9055200026000
0.1039		37	43.00	14.00	9055200026400
0.1063			46.00	16.00	9055200027000
0.1067		36	46.00	16.00	9055200027100
0.1094	7/64		46.00	16.00	9055200027800
0.1098		35	46.00	16.00	9055200027900
0.1102			46.00	16.00	9055200028000
0.1110		34	46.00	16.00	9055200028200
0.1130		33	46.00	16.00	9055200028700
0.1142			46.00	16.00	9055200029000
0.1161		32	46.00	16.00	9055200029500
0.1181			46.00	16.00	9055200030000
0.1201		31	49.00	18.00	9055200030500

Diameter (d1)		Wire / letter	l1 mm	l2 mm	EDP #
Dec. inch	Fract. inch				
0.1220			49.00	18.00	9055200031000
0.1248		1/8	3.170	49.00	9055200031700
0.1260			3.200	49.00	9055200032000
0.1283		30	3.260	49.00	9055200032600
0.1299			3.300	49.00	9055200033000
0.1339			3.400	52.00	9055200034000
0.1358		29	3.450	52.00	9055200034500
0.1378			3.500	52.00	9055200035000
0.1406	9/64		3.570	52.00	9055200035700
0.1417			3.600	52.00	9055200036000
0.1441		27	3.660	52.00	9055200036600
0.1457			3.700	52.00	9055200037000
0.1469		26	3.730	52.00	9055200037300
0.1496		25	3.800	55.00	9055200038000
0.1520		24	3.860	55.00	9055200038600
0.1535			3.900	55.00	9055200039000
0.1539		23	3.910	55.00	9055200039100
0.1563	5/32		3.970	55.00	9055200039700
0.1571		22	3.990	55.00	9055200039900
0.1575			4.000	55.00	9055200040000
0.1591		21	4.040	55.00	9055200040400
0.1610		20	4.090	55.00	9055200040900
0.1614			4.100	55.00	9055200041000
0.1654			4.200	55.00	9055200042000
0.1661		19	4.220	55.00	9055200042200
0.1693		18	4.300	58.00	9055200043000
0.1720	11/64		4.370	58.00	9055200043700
0.1728		17	4.390	58.00	9055200043900
0.1732			4.400	58.00	9055200044000
0.1772		16	4.500	58.00	9055200045000
0.1799		15	4.570	58.00	9055200045700
0.1811			4.600	58.00	9055200046000
0.1819		14	4.620	58.00	9055200046200
0.1850		13	4.700	58.00	9055200047000
0.1874	3/16		4.760	62.00	9055200047600
0.1890		12	4.800	62.00	9055200048000
0.1909		11	4.850	62.00	9055200048500
0.1929			4.900	62.00	9055200049000
0.1937		10	4.920	62.00	9055200049200
0.1961		9	4.980	62.00	9055200049800
0.1969			5.000	62.00	9055200050000
0.1992		8	5.060	62.00	9055200050600
0.2008			5.100	62.00	9055200051000
0.2012		7	5.110	62.00	9055200051100
0.2031	13/64		5.160	62.00	9055200051600
0.2039		6	5.180	62.00	9055200051800
0.2047			5.200	62.00	9055200052000
0.2055		5	5.220	62.00	9055200052200
0.2087			5.300	62.00	9055200053000
0.2091		4	5.310	66.00	9055200053100
0.2126			5.400	66.00	9055200054000
0.2130		3	5.410	66.00	9055200054100
0.2165			5.500	66.00	9055200055000
0.2189	7/32		5.560	66.00	9055200055600

*Items listed in red are non-stocked items, and may take 2 - 6 weeks to receive

Series 5520

Speeds & Feeds information pg 485

Twist Drills

Dec. inch	Diameter (d1)		l1 mm	l2 mm	EDP #	
	Fract. inch	Wire / letter				
0.2205			5.600	66.00	28.00	9055200056000
0.2209		2	5.610	66.00	28.00	9055200056100
0.2244			5.700	66.00	28.00	9055200057000
0.2280		1	5.790	66.00	28.00	9055200057900
0.2283			5.800	66.00	28.00	9055200058000
0.2323			5.900	66.00	28.00	9055200059000
0.2339		A	5.940	66.00	28.00	9055200059400
0.2343	15/64		5.950	66.00	28.00	9055200059500
0.2362			6.000	66.00	28.00	9055200060000
0.2378		B	6.040	70.00	31.00	9055200060400
0.2402			6.100	70.00	31.00	9055200061000
0.2421		C	6.150	70.00	31.00	9055200061500
0.2441			6.200	70.00	31.00	9055200062000
0.2461		D	6.250	70.00	31.00	9055200062500
0.2480			6.300	70.00	31.00	9055200063000
0.2500	1/4	E	6.350	70.00	31.00	9055200063500
0.2520			6.400	70.00	31.00	9055200064000
0.2559			6.500	70.00	31.00	9055200065000
0.2571		F	6.530	70.00	31.00	9055200065300
0.2598			6.600	70.00	31.00	9055200066000
0.2610		G	6.630	70.00	31.00	9055200066300
0.2638			6.700	70.00	31.00	9055200067000
0.2657	17/64		6.750	74.00	34.00	9055200067500
0.2677			6.800	74.00	34.00	9055200068000
0.2717		I	6.900	74.00	34.00	9055200069000
0.2756			7.000	74.00	34.00	9055200070000
0.2768		J	7.030	74.00	34.00	9055200070300
0.2795			7.100	74.00	34.00	9055200071000
0.2811	9/32	K	7.140	74.00	34.00	9055200071400
0.2835			7.200	74.00	34.00	9055200072000
0.2874			7.300	74.00	34.00	9055200073000
0.2902		L	7.370	74.00	34.00	9055200073700
0.2913			7.400	74.00	34.00	9055200074000
0.2949		M	7.490	74.00	34.00	9055200074900
0.2953			7.500	74.00	34.00	9055200075000
0.2969	19/64		7.540	79.00	37.00	9055200075400
0.2992			7.600	79.00	37.00	9055200076000
0.3020		N	7.670	79.00	37.00	9055200076700
0.3031			7.700	79.00	37.00	9055200077000
0.3071			7.800	79.00	37.00	9055200078000
0.3110			7.900	79.00	37.00	9055200079000
0.3126	5/16		7.940	79.00	37.00	9055200079400
0.3150			8.000	79.00	37.00	9055200080000
0.3161		O	8.030	79.00	37.00	9055200080300
0.3189			8.100	79.00	37.00	9055200081000
0.3228		P	8.200	79.00	37.00	9055200082000
0.3268			8.300	79.00	37.00	9055200083000
0.3280	21/64		8.330	79.00	37.00	9055200083300
0.3307			8.400	79.00	37.00	9055200084000
0.3319		Q	8.430	79.00	37.00	9055200084300
0.3346			8.500	79.00	37.00	9055200085000
0.3386			8.600	84.00	40.00	9055200086000
0.3390		R	8.610	84.00	40.00	9055200086100
0.3425			8.700	84.00	40.00	9055200087000

Dec. inch	Diameter (d1)		l1 mm	l2 mm	EDP #	
	Fract. inch	Wire / letter				
0.3437	11/32		8.730	84.00	40.00	9055200087300
0.3465			8.800	84.00	40.00	9055200088000
0.3480		S	8.840	84.00	40.00	9055200088400
0.3504			8.900	84.00	40.00	9055200089000
0.3543			9.000	84.00	40.00	9055200090000
0.3579		T	9.090	84.00	40.00	9055200090900
0.3583			9.100	84.00	40.00	9055200091000
0.3594	23/64		9.130	84.00	40.00	9055200091300
0.3622			9.200	84.00	40.00	9055200092000
0.3661			9.300	84.00	40.00	9055200093000
0.3677		U	9.340	84.00	40.00	9055200093400
0.3701			9.400	84.00	40.00	9055200094000
0.3740			9.500	84.00	40.00	9055200095000
0.3748	3/8		9.520	89.00	43.00	9055200095200
0.3772		V	9.580	89.00	43.00	9055200095800
0.3780			9.600	89.00	43.00	9055200096000
0.3819			9.700	89.00	43.00	9055200097000
0.3858		W	9.800	89.00	43.00	9055200098000
0.3898			9.900	89.00	43.00	9055200099000
0.3906	25/64		9.920	89.00	43.00	9055200099200
0.3937			10.000	89.00	43.00	9055200100000
0.3969		X	10.080	89.00	43.00	9055200100800
0.3976			10.100	89.00	43.00	9055200101000
0.4016			10.200	89.00	43.00	9055200102000
0.4039		Y	10.260	89.00	43.00	9055200102600
0.4055			10.300	89.00	43.00	9055200103000
0.4063	13/32		10.320	89.00	43.00	9055200103200
0.4094			10.400	89.00	43.00	9055200104000
0.4130		Z	10.490	89.00	43.00	9055200104900
0.4134			10.500	89.00	43.00	9055200105000
0.4220	27/64		10.720	95.00	47.00	9055200107200
0.4331			11.000	95.00	47.00	9055200110000
0.4374	7/16		11.110	95.00	47.00	9055200111100
0.4528			11.500	95.00	47.00	9055200115000
0.4531	29/64		11.510	95.00	47.00	9055200115100
0.4689	15/32		11.910	102.00	51.00	9055200119100
0.4724			12.000	102.00	51.00	9055200120000
0.4843	31/64		12.300	102.00	51.00	9055200123000
0.4921			12.500	102.00	51.00	9055200125000
0.5000	1/2		12.700	102.00	51.00	9055200127000
0.5118			13.000	102.00	51.00	9055200130000
0.5157	33/64		13.100	102.00	51.00	9055200131000
0.5311	17/32		13.490	107.00	54.00	9055200134900
0.5315			13.500	107.00	54.00	9055200135000
0.5512			14.000	107.00	54.00	9055200140000
0.5626	9/16		14.290	111.00	56.00	9055200142900

Alternative Drill Series:

- #659 Cobalt, GV120, 3xD, 130 pt, TiN
- #329 Cobalt, GV120, 3xD, 118 pt, Bright/Steam Oxide > 2.36
- #5524 Cobalt, GU500, 3xD, 118 pt, Bright
- #653 HSS, GP, 3xD, 118 pt, TiN

3xD



TiN coated



External Coolant

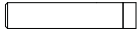

Straight Shank

Speeds & Feeds
information pg 485

Series 5521

GT 500 DZ High-performance

PM-Cobalt, GT 500 DZ parabolic, stub length,
130° cone-relief point, standard straight shank, RH helix

Cut/Shank Dia. = h8 tolerance range

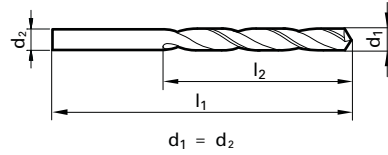

Application Materials:



Universal Steels



Cast Iron



General Steels/Brass

Twist Drills

Dec. inch	Diameter (d1)		l1 mm	l2 mm	EDP #	
	Fract. inch	Wire / letter				
0.0394			1.000	26.00	6.00	9055210010000
0.0433			1.100	28.00	7.00	9055210011000
0.0472			1.200	30.00	8.00	9055210012000
0.0512			1.300	30.00	8.00	9055210013000
0.0551		54	1.400	32.00	9.00	9055210014000
0.0591			1.500	32.00	9.00	9055210015000
0.0626	1/16		1.590	32.00	9.00	9055210015900
0.0630			1.600	34.00	10.00	9055210016000
0.0669		51	1.700	34.00	10.00	9055210017000
0.0709			1.800	36.00	11.00	9055210018000
0.0748			1.900	36.00	11.00	9055210019000
0.0780	5/64		1.980	36.00	11.00	9055210019800
0.0787			2.000	38.00	12.00	9055210020000
0.0827			2.100	38.00	12.00	9055210021000
0.0866			2.200	40.00	13.00	9055210022000
0.0906			2.300	40.00	13.00	9055210023000
0.0937	3/32		2.380	43.00	14.00	9055210023800
0.0945			2.400	43.00	14.00	9055210024000
0.0984			2.500	43.00	14.00	9055210025000
0.1024			2.600	43.00	14.00	9055210026000
0.1063			2.700	46.00	16.00	9055210027000
0.1094	7/64		2.780	46.00	16.00	9055210027800
0.1102			2.800	46.00	16.00	9055210028000
0.1142			2.900	46.00	16.00	9055210029000
0.1181			3.000	46.00	16.00	9055210030000
0.1220			3.100	49.00	18.00	9055210031000
0.1248	1/8		3.170	49.00	18.00	9055210031700
0.1260			3.200	49.00	18.00	9055210032000
0.1299			3.300	49.00	18.00	9055210033000
0.1339			3.400	52.00	20.00	9055210034000
0.1378			3.500	52.00	20.00	9055210035000
0.1406	9/64	28	3.570	52.00	20.00	9055210035700
0.1417			3.600	52.00	20.00	9055210036000
0.1457			3.700	52.00	20.00	9055210037000
0.1496		25	3.800	55.00	22.00	9055210038000
0.1535			3.900	55.00	22.00	9055210039000
0.1563	5/32		3.970	55.00	22.00	9055210039700
0.1575			4.000	55.00	22.00	9055210040000
0.1614			4.100	55.00	22.00	9055210041000
0.1654			4.200	55.00	22.00	9055210042000
0.1693		18	4.300	58.00	24.00	9055210043000
0.1720	11/64		4.370	58.00	24.00	9055210043700
0.1732			4.400	58.00	24.00	9055210044000
0.1772		16	4.500	58.00	24.00	9055210045000
0.1811			4.600	58.00	24.00	9055210046000
0.1850		13	4.700	58.00	24.00	9055210047000
0.1874	3/16		4.760	62.00	26.00	9055210047600
0.1890		12	4.800	62.00	26.00	9055210048000
0.1929			4.900	62.00	26.00	9055210049000
0.1969			5.000	62.00	26.00	9055210050000
0.2008			5.100	62.00	26.00	9055210051000
0.2031	13/64		5.160	62.00	26.00	9055210051600
0.2047			5.200	62.00	26.00	9055210052000

Dec. inch	Diameter (d1)		l1 mm	l2 mm	EDP #	
	Fract. inch	Wire / letter				
0.2087			5.300	62.00	26.00	9055210053000
0.2126			5.400	66.00	28.00	9055210054000
0.2165			5.500	66.00	28.00	9055210055000
0.2189	7/32		5.560	66.00	28.00	9055210055600
0.2205			5.600	66.00	28.00	9055210056000
0.2244			5.700	66.00	28.00	9055210057000
0.2283			5.800	66.00	28.00	9055210058000
0.2323			5.900	66.00	28.00	9055210059000
0.2343	15/64		5.950	66.00	28.00	9055210059500
0.2362			6.000	66.00	28.00	9055210060000
0.2402			6.100	70.00	31.00	9055210061000
0.2441			6.200	70.00	31.00	9055210062000
0.2480			6.300	70.00	31.00	9055210063000
0.2500	1/4	E	6.350	70.00	31.00	9055210063500
0.2520			6.400	70.00	31.00	9055210064000
0.2559			6.500	70.00	31.00	9055210065000
0.2598			6.600	70.00	31.00	9055210066000
0.2638			6.700	70.00	31.00	9055210067000
0.2657	17/64		6.750	70.00	31.00	9055210067500
0.2677			6.800	74.00	34.00	9055210068000
0.2717		I	6.900	74.00	34.00	9055210069000
0.2756			7.000	74.00	34.00	9055210070000
0.2795			7.100	74.00	34.00	9055210071000
0.2811	9/32	K	7.140	74.00	34.00	9055210071400
0.2835			7.200	74.00	34.00	9055210072000
0.2874			7.300	74.00	34.00	9055210073000
0.2913			7.400	74.00	34.00	9055210074000
0.2953			7.500	74.00	34.00	9055210075000
0.2969	19/64		7.540	74.00	34.00	9055210075400
0.2992			7.600	79.00	37.00	9055210076000
0.3031			7.700	79.00	37.00	9055210077000
0.3071			7.800	79.00	37.00	9055210078000
0.3110			7.900	79.00	37.00	9055210079000
0.3126	5/16		7.940	79.00	37.00	9055210079400
0.3150			8.000	79.00	37.00	9055210080000
0.3189			8.100	79.00	37.00	9055210081000
0.3228		P	8.200	79.00	37.00	9055210082000
0.3268			8.300	79.00	37.00	9055210083000
0.3280	21/64		8.330	79.00	37.00	9055210083300
0.3307			8.400	79.00	37.00	9055210084000
0.3346			8.500	79.00	37.00	9055210085000
0.3437	11/32		8.730	84.00	40.00	9055210087300
0.3465			8.800	84.00	40.00	9055210088000
0.3543			9.000	84.00	40.00	9055210090000
0.3594	23/64		9.130	84.00	40.00	9055210091300
0.3661			9.300	84.00	40.00	9055210093000
0.3740			9.500	84.00	40.00	9055210095000
0.3748	3/8		9.520	84.00	40.00	9055210095200
0.3858		W	9.800	89.00	43.00	9055210098000
0.3906	25/64		9.920	89.00	43.00	9055210099200
0.3937			10.000	89.00	43.00	9055210100000
0.4016			10.200	89.00	43.00	9055210102000
0.4063	13/32		10.320	89.00	43.00	9055210103200

*Items listed in red are non-stocked items, and may take 2 - 6 weeks to receive

Series 5521

Speeds & Feeds information pg 485

Diameter (d1)			I1 mm	I2 mm	EDP #	
Dec. inch	Fract. inch	Wire / letter				mm
0.4134			10.500	89.00	43.00	9055210105000
0.4220	27/64		10.720	89.00	43.00	9055210107200
0.4331			11.000	95.00	47.00	9055210110000
0.4374	7/16		11.110	95.00	47.00	9055210111100
0.4528			11.500	95.00	47.00	9055210115000
0.4689	15/32		11.910	95.00	47.00	9055210119100
0.4724			12.000	102.00	51.00	9055210120000
0.4843	31/64		12.300	102.00	51.00	9055210123000
0.4921			12.500	102.00	51.00	9055210125000
0.5000	1/2		12.700	102.00	51.00	9055210127000
0.5118			13.000	102.00	51.00	9055210130000

Diameter (d1)			I1 mm	I2 mm	EDP #	
Dec. inch	Fract. inch	Wire / letter				mm
0.5315			13.500	107.00	54.00	9055210135000
0.5512			14.000	107.00	54.00	9055210140000

Alternative Drill Series:

- #515 PM cobalt, GT500, 3xD, 130 pt, FIREX®
- #659 Cobalt, GV120, 3xD, 130 pt, TiN
- #329 Cobalt, GV120, 3xD, 118 pt, Bright/Steam Oxide > 2.36

5xD

Series 5522

Application Materials:



TiN coated



External Coolant



Straight Shank

Speeds & Feeds
information pg 486

GT 500 DZ High-performance

PM-Cobalt, GT 500 DZ parabolic, jobber length,
130° cone relief point, standard straight shank, RH helix

Cut/Shank Dia. = h8 tolerance range

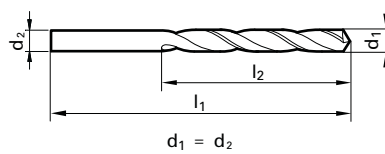

Universal Steels



Cast Iron



General Steels/Brass

Twist Drills

Diameter (d1)			mm	l1 mm	l2 mm	EDP #
Dec. inch	Fract. inch	Wire / letter				
0.0394			1.000	34.00	12.00	9055220010000
0.0433			1.100	36.00	14.00	9055220011000
0.0472			1.200	38.00	16.00	9055220012000
0.0512			1.300	38.00	16.00	9055220013000
0.0551		54	1.400	40.00	18.00	9055220014000
0.0591			1.500	40.00	18.00	9055220015000
0.0626	1/16		1.590	43.00	20.00	9055220015900
0.0630			1.600	43.00	20.00	9055220016000
0.0669		51	1.700	43.00	20.00	9055220017000
0.0709			1.800	46.00	22.00	9055220018000
0.0748			1.900	46.00	22.00	9055220019000
0.0780	5/64		1.980	46.00	22.00	9055220019800
0.0787			2.000	49.00	24.00	9055220020000
0.0827			2.100	49.00	24.00	9055220021000
0.0866			2.200	53.00	27.00	9055220022000
0.0906			2.300	53.00	27.00	9055220023000
0.0937	3/32		2.380	57.00	30.00	9055220023800
0.0945			2.400	57.00	30.00	9055220024000
0.0984			2.500	57.00	30.00	9055220025000
0.1024			2.600	57.00	30.00	9055220026000
0.1063			2.700	61.00	33.00	9055220027000
0.1094	7/64		2.780	61.00	33.00	9055220027800
0.1102			2.800	61.00	33.00	9055220028000
0.1142			2.900	61.00	33.00	9055220029000
0.1181			3.000	61.00	33.00	9055220030000
0.1220			3.100	65.00	36.00	9055220031000
0.1248	1/8		3.170	65.00	36.00	9055220031700
0.1260			3.200	65.00	36.00	9055220032000
0.1299			3.300	65.00	36.00	9055220033000
0.1339			3.400	70.00	39.00	9055220034000
0.1378			3.500	70.00	39.00	9055220035000
0.1406	9/64	28	3.570	70.00	39.00	9055220035700
0.1417			3.600	70.00	39.00	9055220036000
0.1457			3.700	70.00	39.00	9055220037000
0.1496		25	3.800	75.00	43.00	9055220038000
0.1535			3.900	75.00	43.00	9055220039000
0.1563	5/32		3.970	75.00	43.00	9055220039700
0.1575			4.000	75.00	43.00	9055220040000
0.1614			4.100	75.00	43.00	9055220041000
0.1654			4.200	75.00	43.00	9055220042000
0.1693		18	4.300	80.00	47.00	9055220043000
0.1720	11/64		4.370	80.00	47.00	9055220043700
0.1732			4.400	80.00	47.00	9055220044000
0.1772		16	4.500	80.00	47.00	9055220045000
0.1811			4.600	80.00	47.00	9055220046000
0.1850		13	4.700	80.00	47.00	9055220047000
0.1874	3/16		4.760	86.00	52.00	9055220047600
0.1890		12	4.800	86.00	52.00	9055220048000
0.1929			4.900	86.00	52.00	9055220049000

Diameter (d1)			mm	l1 mm	l2 mm	EDP #
Dec. inch	Fract. inch	Wire / letter				
0.1969			5.000	86.00	52.00	9055220050000
0.2008			5.100	86.00	52.00	9055220051000
0.2031	13/64		5.160	86.00	52.00	9055220051600
0.2047			5.200	86.00	52.00	9055220052000
0.2087			5.300	86.00	52.00	9055220053000
0.2126			5.400	93.00	57.00	9055220054000
0.2165			5.500	93.00	57.00	9055220055000
0.2189	7/32		5.560	93.00	57.00	9055220055600
0.2205			5.600	93.00	57.00	9055220056000
0.2244			5.700	93.00	57.00	9055220057000
0.2283			5.800	93.00	57.00	9055220058000
0.2323			5.900	93.00	57.00	9055220059000
0.2343	15/64		5.950	93.00	57.00	9055220059500
0.2362			6.000	93.00	57.00	9055220060000
0.2402			6.100	101.00	63.00	9055220061000
0.2441			6.200	101.00	63.00	9055220062000
0.2480			6.300	101.00	63.00	9055220063000
0.2500	1/4	E	6.350	101.00	63.00	9055220063500
0.2520			6.400	101.00	63.00	9055220064000
0.2559			6.500	101.00	63.00	9055220065000
0.2598			6.600	101.00	63.00	9055220066000
0.2638			6.700	101.00	63.00	9055220067000
0.2657	17/64		6.750	101.00	63.00	9055220067500
0.2677			6.800	109.00	69.00	9055220068000
0.2717		I	6.900	109.00	69.00	9055220069000
0.2756			7.000	109.00	69.00	9055220070000
0.2795			7.100	109.00	69.00	9055220071000
0.2811	9/32	K	7.140	109.00	69.00	9055220071400
0.2835			7.200	109.00	69.00	9055220072000
0.2874			7.300	109.00	69.00	9055220073000
0.2913			7.400	109.00	69.00	9055220074000
0.2953			7.500	109.00	69.00	9055220075000
0.2969	19/64		7.540	109.00	69.00	9055220075400
0.2992			7.600	117.00	75.00	9055220076000
0.3031			7.700	117.00	75.00	9055220077000
0.3071			7.800	117.00	75.00	9055220078000
0.3110			7.900	117.00	75.00	9055220079000
0.3126	5/16		7.940	117.00	75.00	9055220079400
0.3150			8.000	117.00	75.00	9055220080000
0.3189			8.100	117.00	75.00	9055220081000
0.3228		P	8.200	117.00	75.00	9055220082000
0.3268			8.300	117.00	75.00	9055220083000
0.3280	21/64		8.330	117.00	75.00	9055220083300
0.3307			8.400	117.00	75.00	9055220084000
0.3346			8.500	117.00	75.00	9055220085000
0.3437	11/32		8.730	125.00	81.00	9055220087300
0.3465			8.800	125.00	81.00	9055220088000
0.3543			9.000	125.00	81.00	9055220090000
0.3594	23/64		9.130	125.00	81.00	9055220091300

*Items listed in red are non-stocked items, and may take 2 - 6 weeks to receive

Series 5522

Speeds & Feeds information pg 486

Diameter (d1)			mm	l1 mm	l2 mm	EDP #
Dec. inch	Fract. inch	Wire / letter				
0.3661			9.300	125.00	81.00	9055220093000
0.3740			9.500	125.00	81.00	9055220095000
0.3748	3/8		9.520	125.00	81.00	9055220095200
0.3858		W	9.800	133.00	87.00	9055220098000
0.3906	25/64		9.920	133.00	87.00	9055220099200
0.3937			10.000	133.00	87.00	9055220100000
0.4016			10.200	133.00	87.00	9055220102000
0.4063	13/32		10.320	133.00	87.00	9055220103200
0.4134			10.500	133.00	87.00	9055220105000
0.4220	27/64		10.720	133.00	87.00	9055220107200
0.4331			11.000	142.00	94.00	9055220110000
0.4374	7/16		11.110	142.00	94.00	9055220111100
0.4528			11.500	142.00	94.00	9055220115000
0.4689	15/32		11.910	151.00	101.00	9055220119100
0.4724			12.000	151.00	101.00	9055220120000

Diameter (d1)			mm	l1 mm	l2 mm	EDP #
Dec. inch	Fract. inch	Wire / letter				
0.4843	31/64		12.300	151.00	101.00	9055220123000
0.4921			12.500	151.00	101.00	9055220125000
0.5000	1/2		12.700	151.00	101.00	9055220127000
0.5118			13.000	151.00	101.00	9055220130000
0.5315			13.500	160.00	108.00	9055220135000
0.5512			14.000	160.00	108.00	9055220140000

Alternative Drill Series:

- #530 PM Cobalt, GT500, 5xD, 130 pt, FIREX®
- #658 Cobalt, GT100, 5xD, 130 pt, TiN
- #657 Cobalt, Ti, 5xD, 130 pt, TiN
- #622 Cobalt, GT100, 5xD, 130 pt, Bright/Nitrided lands > 2.36

5xD

Series 5523

GU 500 DZ High-performance

Cobalt, GU 500 DZ universal, jobber length, 118° 4-facet split point, standard straight shank, RH helix

Cut/Shank Dia. = h8 tolerance range

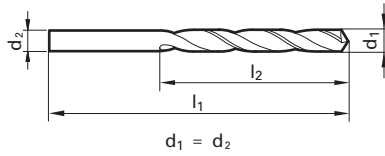

d₁ = d₂



Bright finish



External Coolant



Straight Shank

Speeds & Feeds information pg 486

Application Materials:

- Universal Steels
- Cast Iron
- General Steels/Brass

Twist Drills



Dec. inch	Diameter (d1)		l1 mm	l2 mm	EDP #	
	Fract. inch	Wire / letter				
0.0394			1.000	34.00	12.00	9055230010000
0.0402		60	1.020	34.00	12.00	9055230010200
0.0409		59	1.040	34.00	12.00	9055230010400
0.0421		58	1.070	36.00	14.00	9055230010700
0.0429		57	1.090	36.00	14.00	9055230010900
0.0433			1.100	36.00	14.00	9055230011000
0.0465		56	1.180	36.00	14.00	9055230011800
0.0469		3/64	1.190	38.00	16.00	9055230011900
0.0472			1.200	38.00	16.00	9055230012000
0.0512			1.300	38.00	16.00	9055230013000
0.0520		55	1.320	38.00	16.00	9055230013200
0.0551		54	1.400	40.00	18.00	9055230014000
0.0591			1.500	40.00	18.00	9055230015000
0.0594		53	1.510	43.00	20.00	9055230015100
0.0626		1/16	1.590	43.00	20.00	9055230015900
0.0630			1.600	43.00	20.00	9055230016000
0.0634		52	1.610	43.00	20.00	9055230016100
0.0669		51	1.700	43.00	20.00	9055230017000
0.0701		50	1.780	46.00	22.00	9055230017800
0.0709			1.800	46.00	22.00	9055230018000
0.0728		49	1.850	46.00	22.00	9055230018500
0.0748			1.900	46.00	22.00	9055230019000
0.0760		48	1.930	49.00	24.00	9055230019300
0.0780		5/64	1.980	49.00	24.00	9055230019800
0.0783			1.990	49.00	24.00	9055230019900
0.0787		47	2.000	49.00	24.00	9055230020000
0.0811		46	2.060	49.00	24.00	9055230020600
0.0819		45	2.080	49.00	24.00	9055230020800
0.0827			2.100	49.00	24.00	9055230021000
0.0858		44	2.180	53.00	27.00	9055230021800
0.0866			2.200	53.00	27.00	9055230022000
0.0890		43	2.260	53.00	27.00	9055230022600
0.0906			2.300	53.00	27.00	9055230023000
0.0933		42	2.370	57.00	30.00	9055230023700
0.0937		3/32	2.380	57.00	30.00	9055230023800
0.0945			2.400	57.00	30.00	9055230024000
0.0961		41	2.440	57.00	30.00	9055230024400
0.0980		40	2.490	57.00	30.00	9055230024900
0.0984			2.500	57.00	30.00	9055230025000
0.0996		39	2.530	57.00	30.00	9055230025300
0.1016		38	2.580	57.00	30.00	9055230025800
0.1024			2.600	57.00	30.00	9055230026000
0.1039		37	2.640	57.00	30.00	9055230026400
0.1063			2.700	61.00	33.00	9055230027000
0.1067		36	2.710	61.00	33.00	9055230027100
0.1094		7/64	2.780	61.00	33.00	9055230027800
0.1098			2.790	61.00	33.00	9055230027900
0.1102			2.800	61.00	33.00	9055230028000
0.1110		34	2.820	61.00	33.00	9055230028200
0.1130		33	2.870	61.00	33.00	9055230028700
0.1142			2.900	61.00	33.00	9055230029000
0.1161		32	2.950	61.00	33.00	9055230029500
0.1181			3.000	61.00	33.00	9055230030000
0.1201		31	3.050	65.00	36.00	9055230030500

Dec. inch	Diameter (d1)		l1 mm	l2 mm	EDP #	
	Fract. inch	Wire / letter				
0.1220			3.100	65.00	36.00	9055230031000
0.1248			3.170	65.00	36.00	9055230031700
0.1260		1/8	3.200	65.00	36.00	9055230032000
0.1283		30	3.260	65.00	36.00	9055230032600
0.1299			3.300	65.00	36.00	9055230033000
0.1339			3.400	70.00	39.00	9055230034000
0.1358		29	3.450	70.00	39.00	9055230034500
0.1378			3.500	70.00	39.00	9055230035000
0.1406		9/64	3.570	70.00	39.00	9055230035700
0.1417			3.600	70.00	39.00	9055230036000
0.1441		27	3.660	70.00	39.00	9055230036600
0.1457			3.700	70.00	39.00	9055230037000
0.1469		26	3.730	70.00	39.00	9055230037300
0.1496		25	3.800	75.00	43.00	9055230038000
0.1520		24	3.860	75.00	43.00	9055230038600
0.1535			3.900	75.00	43.00	9055230039000
0.1539		23	3.910	75.00	43.00	9055230039100
0.1563		5/32	3.970	75.00	43.00	9055230039700
0.1571			3.990	75.00	43.00	9055230039900
0.1575		22	4.000	75.00	43.00	9055230040000
0.1591		21	4.040	75.00	43.00	9055230040400
0.1610		20	4.090	75.00	43.00	9055230040900
0.1614			4.100	75.00	43.00	9055230041000
0.1654			4.200	75.00	43.00	9055230042000
0.1661		19	4.220	75.00	43.00	9055230042200
0.1693		18	4.300	80.00	47.00	9055230043000
0.1720		11/64	4.370	80.00	47.00	9055230043700
0.1728			4.390	80.00	47.00	9055230043900
0.1732		17	4.400	80.00	47.00	9055230044000
0.1772		16	4.500	80.00	47.00	9055230045000
0.1799		15	4.570	80.00	47.00	9055230045700
0.1811			4.600	80.00	47.00	9055230046000
0.1819		14	4.620	80.00	47.00	9055230046200
0.1850		13	4.700	80.00	47.00	9055230047000
0.1874		3/16	4.760	86.00	52.00	9055230047600
0.1890			4.800	86.00	52.00	9055230048000
0.1909		12	4.850	86.00	52.00	9055230048500
0.1929			4.900	86.00	52.00	9055230049000
0.1937		10	4.920	86.00	52.00	9055230049200
0.1961		9	4.980	86.00	52.00	9055230049800
0.1969			5.000	86.00	52.00	9055230050000
0.1992		8	5.060	86.00	52.00	9055230050600
0.2008			5.100	86.00	52.00	9055230051000
0.2012		7	5.110	86.00	52.00	9055230051100
0.2031		13/64	5.160	86.00	52.00	9055230051600
0.2039			5.180	86.00	52.00	9055230051800
0.2047		6	5.200	86.00	52.00	9055230052000
0.2055			5.220	86.00	52.00	9055230052200
0.2087		5	5.300	86.00	52.00	9055230053000
0.2091		4	5.310	93.00	57.00	9055230053100
0.2126			5.400	93.00	57.00	9055230054000
0.2130		3	5.410	93.00	57.00	9055230054100
0.2165			5.500	93.00	57.00	9055230055000
0.2189		7/32	5.560	93.00	57.00	9055230055600

*Items listed in red are non-stocked items, and may take 2 - 6 weeks to receive

Series 5523

Speeds & Feeds information pg 486

Dec. inch	Diameter (d1)		l1 mm	l2 mm	EDP #	
	Fract. inch	Wire / letter				
0.2205			5.600	93.00	57.00	9055230056000
0.2209		2	5.610	93.00	57.00	9055230056100
0.2244			5.700	93.00	57.00	9055230057000
0.2280		1	5.790	93.00	57.00	9055230057900
0.2283			5.800	93.00	57.00	9055230058000
0.2323			5.900	93.00	57.00	9055230059000
0.2339		A	5.940	93.00	57.00	9055230059400
0.2343	15/64		5.950	93.00	57.00	9055230059500
0.2362			6.000	93.00	57.00	9055230060000
0.2378		B	6.040	101.00	63.00	9055230060400
0.2402			6.100	101.00	63.00	9055230061000
0.2421		C	6.150	101.00	63.00	9055230061500
0.2441			6.200	101.00	63.00	9055230062000
0.2461		D	6.250	101.00	63.00	9055230062500
0.2480			6.300	101.00	63.00	9055230063000
0.2500	1/4	E	6.350	101.00	63.00	9055230063500
0.2520			6.400	101.00	63.00	9055230064000
0.2559			6.500	101.00	63.00	9055230065000
0.2571		F	6.530	101.00	63.00	9055230065300
0.2598			6.600	101.00	63.00	9055230066000
0.2610		G	6.630	101.00	63.00	9055230066300
0.2638			6.700	101.00	63.00	9055230067000
0.2657	17/64		6.750	109.00	69.00	9055230067500
0.2677			6.800	109.00	69.00	9055230068000
0.2717		I	6.900	109.00	69.00	9055230069000
0.2756			7.000	109.00	69.00	9055230070000
0.2768		J	7.030	109.00	69.00	9055230070300
0.2795			7.100	109.00	69.00	9055230071000
0.2811	9/32	K	7.140	109.00	69.00	9055230071400
0.2835			7.200	109.00	69.00	9055230072000
0.2874			7.300	109.00	69.00	9055230073000
0.2902		L	7.370	109.00	69.00	9055230073700
0.2913			7.400	109.00	69.00	9055230074000
0.2949		M	7.490	109.00	69.00	9055230074900
0.2953			7.500	109.00	69.00	9055230075000
0.2969	19/64		7.540	117.00	75.00	9055230075400
0.2992			7.600	117.00	75.00	9055230076000
0.3020		N	7.670	117.00	75.00	9055230076700
0.3031			7.700	117.00	75.00	9055230077000
0.3071			7.800	117.00	75.00	9055230078000
0.3110			7.900	117.00	75.00	9055230079000
0.3126	5/16		7.940	117.00	75.00	9055230079400
0.3150			8.000	117.00	75.00	9055230080000
0.3161		O	8.030	117.00	75.00	9055230080300
0.3189			8.100	117.00	75.00	9055230081000
0.3228		P	8.200	117.00	75.00	9055230082000
0.3268			8.300	117.00	75.00	9055230083000
0.3280	21/64		8.330	117.00	75.00	9055230083300
0.3307			8.400	117.00	75.00	9055230084000
0.3319		Q	8.430	117.00	75.00	9055230084300
0.3346			8.500	117.00	75.00	9055230085000
0.3386			8.600	125.00	81.00	9055230086000
0.3390		R	8.610	125.00	81.00	9055230086100
0.3425			8.700	125.00	81.00	9055230087000

Dec. inch	Diameter (d1)		l1 mm	l2 mm	EDP #	
	Fract. inch	Wire / letter				
0.3437	11/32		8.730	125.00	81.00	9055230087300
0.3465			8.800	125.00	81.00	9055230088000
0.3480		S	8.840	125.00	81.00	9055230088400
0.3504			8.900	125.00	81.00	9055230089000
0.3543			9.000	125.00	81.00	9055230090000
0.3579		T	9.090	125.00	81.00	9055230090900
0.3583			9.100	125.00	81.00	9055230091000
0.3594	23/64		9.130	125.00	81.00	9055230091300
0.3622			9.200	125.00	81.00	9055230092000
0.3661			9.300	125.00	81.00	9055230093000
0.3677		U	9.340	125.00	81.00	9055230093400
0.3701			9.400	125.00	81.00	9055230094000
0.3740			9.500	125.00	81.00	9055230095000
0.3748	3/8		9.520	133.00	87.00	9055230095200
0.3772		V	9.580	133.00	87.00	9055230095800
0.3780			9.600	133.00	87.00	9055230096000
0.3819			9.700	133.00	87.00	9055230097000
0.3858		W	9.800	133.00	87.00	9055230098000
0.3898			9.900	133.00	87.00	9055230099000
0.3906	25/64		9.920	133.00	87.00	9055230099200
0.3937			10.000	133.00	87.00	9055230100000
0.3969		X	10.080	133.00	87.00	9055230100800
0.3976			10.100	133.00	87.00	9055230101000
0.4016			10.200	133.00	87.00	9055230102000
0.4039		Y	10.260	133.00	87.00	9055230102600
0.4055			10.300	133.00	87.00	9055230103000
0.4063	13/32		10.320	133.00	87.00	9055230103200
0.4094			10.400	133.00	87.00	9055230104000
0.4130		Z	10.490	133.00	87.00	9055230104900
0.4134			10.500	133.00	87.00	9055230105000
0.4220	27/64		10.720	142.00	94.00	9055230107200
0.4331			11.000	142.00	94.00	9055230110000
0.4374	7/16		11.110	142.00	94.00	9055230111100
0.4528			11.500	142.00	94.00	9055230115000
0.4531	29/64		11.510	142.00	94.00	9055230115100
0.4689	15/32		11.910	151.00	101.00	9055230119100
0.4724			12.000	151.00	101.00	9055230120000
0.4843	31/64		12.300	151.00	101.00	9055230123000
0.4921			12.500	151.00	101.00	9055230125000
0.5000	1/2		12.700	151.00	101.00	9055230127000
0.5118			13.000	151.00	101.00	9055230130000
0.5157	33/64		13.100	151.00	101.00	9055230131000
0.5311	17/32		13.490	160.00	108.00	9055230134900
0.5315			13.500	160.00	108.00	9055230135000
0.5512			14.000	160.00	108.00	9055230140000
0.5626	9/16		14.290	169.00	114.00	9055230142900

Alternative Drill Series:

- #5519 Cobalt, GU500, 5xD, 118 pt, TiN
- #657 Cobalt, Ti, 5xD, 130 pt, TiN
- #622 Cobalt, GT100, 5xD, 130 pt, Bright/Nitrided lands > 2.36
- #530 PM Cobalt, GT500, 5xD, 130 pt, FIREX®

3xD

Series 5524



Bright finish

GU 500 DZ High-performance

Application Materials:



Universal Steels



Cast Iron



General Steels/Brass

Twist Drills



External Coolant

Cobalt, GU 500 DZ universal, stub length, 118° 4-facet split point, standard straight shank, RH helix

Cut/Shank Dia. = h8 tolerance range

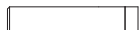

Straight Shank

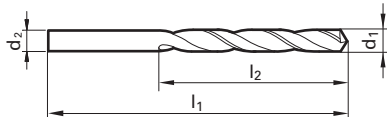

$d_1 = d_2$

Speeds & Feeds information pg 487

GUHRING
Select

Dec. inch	Diameter (d1)		l1 mm	l2 mm	EDP #
	Fract. inch	Wire / letter mm			
0.0394		1.000	26.00	6.00	9055240010000
0.0402		1.020	26.00	6.00	9055240010200
0.0409		1.040	26.00	6.00	9055240010400
0.0421		1.070	28.00	7.00	9055240010700
0.0429		1.090	28.00	7.00	9055240010900
0.0433		1.100	28.00	7.00	9055240011000
0.0465		1.180	28.00	7.00	9055240011800
0.0469	3/64	1.190	28.00	7.00	9055240011900
0.0472		1.200	28.00	7.00	9055240012000
0.0512		1.300	28.00	7.00	9055240013000
0.0520		1.320	28.00	7.00	9055240013200
0.0551		1.400	32.00	9.00	9055240014000
0.0591		1.500	32.00	9.00	9055240015000
0.0594		1.510	34.00	10.00	9055240015100
0.0626	1/16	1.590	34.00	10.00	9055240015900
0.0630		1.600	34.00	10.00	9055240016000
0.0634		1.610	34.00	10.00	9055240016100
0.0669		1.700	34.00	10.00	9055240017000
0.0701		1.780	36.00	11.00	9055240017800
0.0709		1.800	36.00	11.00	9055240018000
0.0728		1.850	36.00	11.00	9055240018500
0.0748		1.900	36.00	11.00	9055240019000
0.0760		1.930	38.00	12.00	9055240019300
0.0780	5/64	1.980	38.00	12.00	9055240019800
0.0783		1.990	38.00	12.00	9055240019900
0.0787		2.000	38.00	12.00	9055240020000
0.0811		2.060	38.00	12.00	9055240020600
0.0819		2.080	38.00	12.00	9055240020800
0.0827		2.100	38.00	12.00	9055240021000
0.0858		2.180	40.00	13.00	9055240021800
0.0866		2.200	40.00	13.00	9055240022000
0.0890		2.260	40.00	13.00	9055240022600
0.0906		2.300	40.00	13.00	9055240023000
0.0933		2.370	43.00	14.00	9055240023700
0.0937	3/32	2.380	43.00	14.00	9055240023800
0.0945		2.400	43.00	14.00	9055240024000
0.0961		2.440	43.00	14.00	9055240024400
0.0980		2.490	43.00	14.00	9055240024900
0.0984		2.500	43.00	14.00	9055240025000
0.0996		2.530	43.00	14.00	9055240025300
0.1016		2.580	43.00	14.00	9055240025800
0.1024		2.600	43.00	14.00	9055240026000
0.1039		2.640	43.00	14.00	9055240026400
0.1063		2.700	46.00	16.00	9055240027000
0.1067		2.710	46.00	16.00	9055240027100
0.1094	7/64	2.780	46.00	16.00	9055240027800
0.1098		2.790	46.00	16.00	9055240027900
0.1102		2.800	46.00	16.00	9055240028000
0.1110		2.820	46.00	16.00	9055240028200
0.1130		2.870	46.00	16.00	9055240028700
0.1142		2.900	46.00	16.00	9055240029000
0.1161		2.950	46.00	16.00	9055240029500
0.1181		3.000	46.00	16.00	9055240030000
0.1201		3.050	49.00	18.00	9055240030500

Dec. inch	Diameter (d1)		l1 mm	l2 mm	EDP #
	Fract. inch	Wire / letter mm			
0.1220		3.100	49.00	18.00	9055240031000
0.1248		3.170	49.00	18.00	9055240031700
0.1260	1/8	3.200	49.00	18.00	9055240032000
0.1283		3.260	49.00	18.00	9055240032600
0.1299		3.300	49.00	18.00	9055240033000
0.1339		3.400	52.00	20.00	9055240034000
0.1358		3.450	52.00	20.00	9055240034500
0.1378		3.500	52.00	20.00	9055240035000
0.1406	9/64	3.570	52.00	20.00	9055240035700
0.1417		3.600	52.00	20.00	9055240036000
0.1441		3.660	52.00	20.00	9055240036600
0.1457		3.700	52.00	20.00	9055240037000
0.1469		3.730	52.00	20.00	9055240037300
0.1496		3.800	55.00	22.00	9055240038000
0.1520		3.860	55.00	22.00	9055240038600
0.1535		3.900	55.00	22.00	9055240039000
0.1539		3.910	55.00	22.00	9055240039100
0.1563	5/32	3.970	55.00	22.00	9055240039700
0.1571		3.990	55.00	22.00	9055240039900
0.1575		4.000	55.00	22.00	9055240040000
0.1591		4.040	55.00	22.00	9055240040400
0.1610		4.090	55.00	22.00	9055240040900
0.1614		4.100	55.00	22.00	9055240041000
0.1654		4.200	55.00	22.00	9055240042000
0.1661		4.220	55.00	22.00	9055240042200
0.1693		4.300	58.00	24.00	9055240043000
0.1720	11/64	4.370	58.00	24.00	9055240043700
0.1728		4.390	58.00	24.00	9055240043900
0.1732		4.400	58.00	24.00	9055240044000
0.1772		4.500	58.00	24.00	9055240045000
0.1799		4.570	58.00	24.00	9055240045700
0.1811		4.600	58.00	24.00	9055240046000
0.1819		4.620	58.00	24.00	9055240046200
0.1850		4.700	58.00	24.00	9055240047000
0.1874	3/16	4.760	62.00	26.00	9055240047600
0.1890		4.800	62.00	26.00	9055240048000
0.1909		4.850	62.00	26.00	9055240048500
0.1929		4.900	62.00	26.00	9055240049000
0.1937		4.920	62.00	26.00	9055240049200
0.1961		4.980	62.00	26.00	9055240049800
0.1969		5.000	62.00	26.00	9055240050000
0.1992		5.060	62.00	26.00	9055240050600
0.2008		5.100	62.00	26.00	9055240051000
0.2012		5.110	62.00	26.00	9055240051100
0.2031	13/64	5.160	62.00	26.00	9055240051600
0.2039		5.180	62.00	26.00	9055240051800
0.2047		5.200	62.00	26.00	9055240052000
0.2055		5.220	62.00	26.00	9055240052200
0.2087		5.300	62.00	26.00	9055240053000
0.2091		5.310	66.00	28.00	9055240053100
0.2126		5.400	66.00	28.00	9055240054000
0.2130		5.410	66.00	28.00	9055240054100
0.2165		5.500	66.00	28.00	9055240055000
0.2189	7/32	5.560	66.00	28.00	9055240055600

*Items listed in red are non-stocked items, and may take 2 - 6 weeks to receive

Series 5524

Speeds & Feeds information pg 487

Diameter (d1)		Wire / letter	l1 mm	l2 mm	EDP #
Dec. inch	Fract. inch				
0.2205			66.00	28.00	9055240056000
0.2209		2	56.10	66.00	9055240056100
0.2244			5.700	66.00	9055240057000
0.2280		1	5.790	66.00	9055240057900
0.2283			5.800	66.00	9055240058000
0.2323			5.900	66.00	9055240059000
0.2339		A	5.940	66.00	9055240059400
0.2343	15/64		5.950	66.00	9055240059500
0.2362			6.000	66.00	9055240060000
0.2378		B	6.040	70.00	9055240060400
0.2402			6.100	70.00	9055240061000
0.2421		C	6.150	70.00	9055240061500
0.2441			6.200	70.00	9055240062000
0.2461		D	6.250	70.00	9055240062500
0.2480			6.300	70.00	9055240063000
0.2500	1/4	E	6.350	70.00	9055240063500
0.2520			6.400	70.00	9055240064000
0.2559			6.500	70.00	9055240065000
0.2571		F	6.530	70.00	9055240065300
0.2598			6.600	70.00	9055240066000
0.2610		G	6.630	70.00	9055240066300
0.2638			6.700	70.00	9055240067000
0.2657	17/64		6.750	74.00	9055240067500
0.2677			6.800	74.00	9055240068000
0.2717		I	6.900	74.00	9055240069000
0.2756			7.000	74.00	9055240070000
0.2768		J	7.030	74.00	9055240070300
0.2795			7.100	74.00	9055240071000
0.2811	9/32	K	7.140	74.00	9055240071400
0.2835			7.200	74.00	9055240072000
0.2874			7.300	74.00	9055240073000
0.2902		L	7.370	74.00	9055240073700
0.2913			7.400	74.00	9055240074000
0.2949		M	7.490	74.00	9055240074900
0.2953			7.500	74.00	9055240075000
0.2969	19/64		7.540	79.00	9055240075400
0.2992			7.600	79.00	9055240076000
0.3020		N	7.670	79.00	9055240076700
0.3031			7.700	79.00	9055240077000
0.3071			7.800	79.00	9055240078000
0.3110			7.900	79.00	9055240079000
0.3126	5/16		7.940	79.00	9055240079400
0.3150			8.000	79.00	9055240080000
0.3161		O	8.030	79.00	9055240080300
0.3189			8.100	79.00	9055240081000
0.3228		P	8.200	79.00	9055240082000
0.3268			8.300	79.00	9055240083000
0.3280	21/64		8.330	79.00	9055240083300
0.3307			8.400	79.00	9055240084000
0.3319		Q	8.430	79.00	9055240084300
0.3346			8.500	79.00	9055240085000
0.3386			8.600	84.00	9055240086000
0.3390		R	8.610	84.00	9055240086100
0.3425			8.700	84.00	9055240087000
0.3437	11/32		8.730	84.00	9055240087300

Diameter (d1)		Wire / letter	l1 mm	l2 mm	EDP #
Dec. inch	Fract. inch				
0.3465			84.00	40.00	9055240088000
0.3480		S	8.840	84.00	9055240088400
0.3504			8.900	84.00	9055240089000
0.3543			9.000	84.00	9055240090000
0.3579		T	9.090	84.00	9055240090900
0.3583			9.100	84.00	9055240091000
0.3594	23/64		9.130	84.00	9055240091300
0.3622			9.200	84.00	9055240092000
0.3661			9.300	84.00	9055240093000
0.3677		U	9.340	84.00	9055240093400
0.3701			9.400	84.00	9055240094000
0.3740			9.500	84.00	9055240095000
0.3748	3/8		9.520	89.00	9055240095200
0.3772		V	9.580	89.00	9055240095800
0.3780			9.600	89.00	9055240096000
0.3819			9.700	89.00	9055240097000
0.3858		W	9.800	89.00	9055240098000
0.3898			9.900	89.00	9055240099000
0.3906	25/64		9.920	89.00	9055240099200
0.3937			10.000	89.00	9055240100000
0.3969		X	10.080	89.00	9055240100800
0.3976			10.100	89.00	9055240101000
0.4016			10.200	89.00	9055240102000
0.4039		Y	10.260	89.00	9055240102600
0.4055			10.300	89.00	9055240103000
0.4063	13/32		10.320	89.00	9055240103200
0.4094			10.400	89.00	9055240104000
0.4130		Z	10.490	89.00	9055240104900
0.4134			10.500	89.00	9055240105000
0.4220	27/64		10.720	95.00	9055240107200
0.4331			11.000	95.00	9055240110000
0.4374	7/16		11.110	95.00	9055240111100
0.4528			11.500	95.00	9055240115000
0.4531	29/64		11.510	95.00	9055240115100
0.4689	15/32		11.910	102.00	9055240119100
0.4724			12.000	102.00	9055240120000
0.4843	31/64		12.300	102.00	9055240123000
0.4921			12.500	102.00	9055240125000
0.5000	1/2		12.700	102.00	9055240127000
0.5118			13.000	102.00	9055240130000
0.5157	33/64		13.100	102.00	9055240131000
0.5311	17/32		13.490	107.00	9055240134900
0.5315			13.500	107.00	9055240135000
0.5512			14.000	107.00	9055240140000
0.5626	9/16		14.290	111.00	9055240142900

Alternative Drill Series:

- #5520 Cobalt, GU500, 3xD, 118 pt, TiN
- #659 Cobalt, GV120, 3xD, 130 pt, TiN
- #329 Cobalt, GV120, 3xD, 118 pt, Bright/Steam Oxide > 2.36

12xD

Series 5525

N

nano-FIREX® coated



Coilant Through



Reinforced Straight Shank

Speeds & Feeds
information pg 487

RT 100 C High Penetration

Carbide, RT 100 C high penetration, 12xD, self-centering
135° SC, double margin, reinforced straight shank, RH helix

Cut Dia. = h7 tolerance range, Shank Dia. = h6

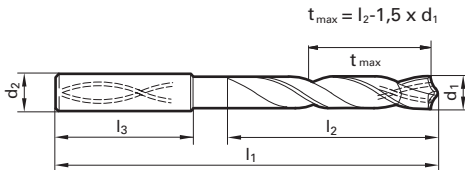

Application Materials:

- General Steels/Brass
- Universal Steels
- Stainless Steels
- Hardened Materials
- Cast Iron
- Ti & Ni Alloys

Twist Drills



Diameter (d1)		Wire / letter	mm	d2 mm	l1 mm	l2 mm	EDP #
Dec. inch	Fract. inch						
0.1181			3.000	6.000	90.00	50.00	9055250030000
0.1220			3.100	6.000	90.00	50.00	9055250031000
0.1250	1/8		3.170	6.000	90.00	50.00	9055250031700
0.1260			3.200	6.000	90.00	50.00	9055250032000
0.1280			3.250	6.000	90.00	50.00	9055250032500
0.1299			3.300	6.000	90.00	50.00	9055250033000
0.1339			3.400	6.000	90.00	50.00	9055250034000
0.1378			3.500	6.000	90.00	50.00	9055250035000
0.1406	9/64		3.570	6.000	90.00	50.00	9055250035700
0.1417			3.600	6.000	90.00	50.00	9055250036000
0.1457			3.700	6.000	90.00	50.00	9055250037000
0.1496		25	3.800	6.000	90.00	50.00	9055250038000
0.1535			3.900	6.000	90.00	50.00	9055250039000
0.1563	5/32		3.970	6.000	90.00	50.00	9055250039700
0.1575			4.000	6.000	102.00	64.00	9055250040000
0.1614			4.100	6.000	102.00	64.00	9055250041000
0.1654			4.200	6.000	102.00	64.00	9055250042000
0.1693		18	4.300	6.000	102.00	64.00	9055250043000
0.1720	11/64		4.370	6.000	102.00	64.00	9055250043700
0.1732			4.400	6.000	102.00	64.00	9055250044000
0.1772		16	4.500	6.000	102.00	64.00	9055250045000
0.1811			4.600	6.000	102.00	64.00	9055250046000
0.1831			4.650	6.000	102.00	64.00	9055250046500
0.1850			4.700	6.000	102.00	64.00	9055250047000
0.1874	3/16		4.760	6.000	102.00	64.00	9055250047600
0.1890			4.800	6.000	116.00	78.00	9055250048000
0.1929			4.900	6.000	116.00	78.00	9055250049000
0.1969			5.000	6.000	116.00	78.00	9055250050000
0.2008			5.100	6.000	116.00	78.00	9055250051000
0.2031	13/64		5.160	6.000	116.00	78.00	9055250051600
0.2047			5.200	6.000	116.00	78.00	9055250052000
0.2087			5.300	6.000	116.00	78.00	9055250053000
0.2126			5.400	6.000	116.00	78.00	9055250054000
0.2165			5.500	6.000	116.00	78.00	9055250055000
0.2189	7/32		5.560	6.000	116.00	78.00	9055250055600
0.2205			5.600	6.000	116.00	78.00	9055250056000
0.2244			5.700	6.000	116.00	78.00	9055250057000
0.2283			5.800	6.000	116.00	78.00	9055250058000
0.2323			5.900	6.000	116.00	78.00	9055250059000
0.2343	15/64		5.950	6.000	116.00	78.00	9055250059500
0.2362			6.000	6.000	116.00	78.00	9055250060000
0.2402			6.100	8.000	146.00	108.00	9055250061000
0.2441			6.200	8.000	146.00	108.00	9055250062000
0.2480			6.300	8.000	146.00	108.00	9055250063000
0.2500	1/4	E	6.350	8.000	146.00	108.00	9055250063500
0.2520			6.400	8.000	146.00	108.00	9055250064000
0.2559			6.500	8.000	146.00	108.00	9055250065000
0.2598			6.600	8.000	146.00	108.00	9055250066000
0.2638			6.700	8.000	146.00	108.00	9055250067000
0.2657	17/64		6.750	8.000	146.00	108.00	9055250067500

Diameter (d1)		Wire / letter	mm	d2 mm	l1 mm	l2 mm	EDP #
Dec. inch	Fract. inch						
0.2677			6.800	8.000	146.00	108.00	9055250068000
0.2717			6.900	8.000	146.00	108.00	9055250069000
0.2756			7.000	8.000	146.00	108.00	9055250070000
0.2795			7.100	8.000	146.00	108.00	9055250071000
0.2811	9/32		7.140	8.000	146.00	108.00	9055250071400
0.2835			7.200	8.000	146.00	108.00	9055250072000
0.2874			7.300	8.000	146.00	108.00	9055250073000
0.2913			7.400	8.000	146.00	108.00	9055250074000
0.2953			7.500	8.000	146.00	108.00	9055250075000
0.2969	19/64		7.540	8.000	146.00	108.00	9055250075400
0.2992			7.600	8.000	146.00	108.00	9055250076000
0.3031			7.700	8.000	146.00	108.00	9055250077000
0.3071			7.800	8.000	146.00	108.00	9055250078000
0.3110			7.900	8.000	146.00	108.00	9055250079000
0.3126	5/16		7.940	8.000	146.00	108.00	9055250079400
0.3150			8.000	8.000	146.00	108.00	9055250080000
0.3189			8.100	10.000	162.00	120.00	9055250081000
0.3228			8.200	10.000	162.00	120.00	9055250082000
0.3268			8.300	10.000	162.00	120.00	9055250083000
0.3280	21/64		8.330	10.000	162.00	120.00	9055250083300
0.3307			8.400	10.000	162.00	120.00	9055250084000
0.3346			8.500	10.000	162.00	120.00	9055250085000
0.3386			8.600	10.000	162.00	120.00	9055250086000
0.3425			8.700	10.000	162.00	120.00	9055250087000
0.3437	11/32		8.730	10.000	162.00	120.00	9055250087300
0.3465			8.800	10.000	162.00	120.00	9055250088000
0.3504			8.900	10.000	162.00	120.00	9055250089000
0.3543			9.000	10.000	162.00	120.00	9055250090000
0.3583			9.100	10.000	162.00	120.00	9055250091000
0.3594	23/64		9.130	10.000	162.00	120.00	9055250091300
0.3622			9.200	10.000	162.00	120.00	9055250092000
0.3642			9.250	10.000	162.00	120.00	9055250092500
0.3661			9.300	10.000	162.00	120.00	9055250093000
0.3701			9.400	10.000	162.00	120.00	9055250094000
0.3740			9.500	10.000	162.00	120.00	9055250095000
0.3748	3/8		9.520	10.000	162.00	120.00	9055250095200
0.3780			9.600	10.000	162.00	120.00	9055250096000
0.3819			9.700	10.000	162.00	120.00	9055250097000
0.3858			9.800	10.000	162.00	120.00	9055250098000
0.3898			9.900	10.000	162.00	120.00	9055250099000
0.3906	25/64		9.920	10.000	162.00	120.00	9055250099200
0.3937			10.000	10.000	162.00	120.00	9055250100000
0.3976			10.100	12.000	204.00	156.00	9055250101000
0.4016			10.200	12.000	204.00	156.00	9055250102000
0.4055			10.300	12.000	204.00	156.00	9055250103000
0.4063	13/32		10.320	12.000	204.00	156.00	9055250103200
0.4134			10.500	12.000	204.00	156.00	9055250105000
0.4173			10.600	12.000	204.00	156.00	9055250106000
0.4213			10.700	12.000	204.00	156.00	9055250107000
0.4220	27/64		10.720	12.000	204.00	156.00	9055250107200



All deep hole drills must utilize a pilot hole.

Deep hole drills must never operate at full speed without support in the pilot hole.

Series 5525

Speeds & Feeds information pg 487

Twist Drills

Dec. inch	Diameter (d1)		d2 mm	l1 mm	l2 mm	EDP #	
	Fract. inch	Wire / letter					
0.4252			10.800	12.000	204.00	156.00	9055250108000
0.4291			10.900	12.000	204.00	156.00	9055250109000
0.4331			11.000	12.000	204.00	156.00	9055250110000
0.4374	7/16		11.110	12.000	204.00	156.00	9055250111100
0.4528			11.500	12.000	204.00	156.00	9055250115000
0.4531	29/64		11.510	12.000	204.00	156.00	9055250115100
0.4689	15/32		11.910	12.000	204.00	156.00	9055250119100
0.4724			12.000	12.000	204.00	156.00	9055250120000
0.4843	31/64		12.300	14.000	230.00	182.00	9055250123000
0.4921			12.500	14.000	230.00	182.00	9055250125000
0.5000	1/2		12.700	14.000	230.00	182.00	9055250127000
0.5118			13.000	14.000	230.00	182.00	9055250130000
0.5311	17/32		13.490	14.000	230.00	182.00	9055250134900
0.5315			13.500	14.000	230.00	182.00	9055250135000
0.5469	35/64		13.890	14.000	230.00	182.00	9055250138900
0.5512			14.000	14.000	230.00	182.00	9055250140000
0.5709			14.500	16.000	260.00	208.00	9055250145000
0.5906			15.000	16.000	260.00	208.00	9055250150000
0.6094	39/64		15.480	16.000	260.00	208.00	9055250154800

Dec. inch	Diameter (d1)		d2 mm	l1 mm	l2 mm	EDP #	
	Fract. inch	Wire / letter					
0.6102			15.500	16.000	260.00	208.00	9055250155000
0.6299			16.000	16.000	260.00	208.00	9055250160000
0.6496			16.500	18.000	285.00	234.00	9055250165000
0.6693			17.000	18.000	285.00	234.00	9055250170000
0.6890			17.500	18.000	285.00	234.00	9055250175000
0.7087			18.000	18.000	285.00	234.00	9055250180000
0.7283			18.500	20.000	285.00	234.00	9055250185000
0.7480			19.000	20.000	310.00	258.00	9055250190000
0.7500	3/4		19.050	20.000	310.00	258.00	9055250190500
0.7677			19.500	20.000	310.00	258.00	9055250195000
0.7874			20.000	20.000	310.00	258.00	9055250200000

Alternative Drill Series:

#5512 Carbide, RT100, 7xD, 140 U pt, FIREX®
 #6511 Carbide, FT100T, 20xD, 135 pt, TiAIN tipped



All deep hole drills must utilize a pilot hole.

Deep hole drills must never operate at full speed without support in the pilot hole.

10xD



Bright finish



External Coolant



Reinforced Straight Shank

Speeds & Feeds information pg 488

Series 5536

GU 500 DZ High-performance

Cobalt, GU 500 DZ universal, taper length, 118° 4-facet split point, standard straight shank, RH helix

Cut/Shank Dia. = h8 tolerance range

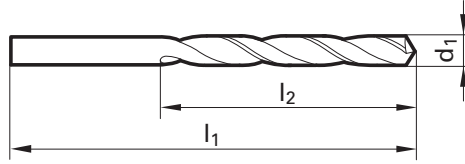

Application Materials:



Universal Steels



Cast Iron



General Steels/Brass

Twist Drills



Diameter (d1)		Wire / letter	d2	l1	l2	EDP #
Dec. inch	Fract. inch					
0.0394			1.000	56.00	33.00	9055360010000
0.0402		60	1.020	56.00	33.00	9055360010200
0.0409		59	1.040	56.00	33.00	9055360010400
0.0421		58	1.070	60.00	37.00	9055360010700
0.0429		57	1.090	60.00	37.00	9055360010900
0.0433			1.100	60.00	37.00	9055360011000
0.0465		56	1.180	60.00	37.00	9055360011800
0.0469	3/64		1.190	65.00	41.00	9055360011900
0.0472			1.200	65.00	41.00	9055360012000
0.0512			1.300	65.00	41.00	9055360013000
0.0520		55	1.320	65.00	41.00	9055360013200
0.0551		54	1.400	70.00	45.00	9055360014000
0.0591			1.500	70.00	45.00	9055360015000
0.0594		53	1.510	76.00	50.00	9055360015100
0.0626	1/16		1.590	76.00	50.00	9055360015900
0.0630			1.600	76.00	50.00	9055360016000
0.0634		52	1.610	76.00	50.00	9055360016100
0.0669		51	1.700	76.00	50.00	9055360017000
0.0701		50	1.780	80.00	53.00	9055360017800
0.0709			1.800	80.00	53.00	9055360018000
0.0728		49	1.850	80.00	53.00	9055360018500
0.0748			1.900	80.00	53.00	9055360019000
0.0760		48	1.930	85.00	56.00	9055360019300
0.0780	5/64		1.980	85.00	56.00	9055360019800
0.0783		47	1.990	85.00	56.00	9055360019900
0.0787			2.000	85.00	56.00	9055360020000
0.0811		46	2.060	85.00	56.00	9055360020600
0.0819		45	2.080	85.00	56.00	9055360020800
0.0827			2.100	85.00	56.00	9055360021000
0.0858		44	2.180	90.00	59.00	9055360021800
0.0866			2.200	90.00	59.00	9055360022000
0.0890		43	2.260	90.00	59.00	9055360022600
0.0906			2.300	90.00	59.00	9055360023000
0.0933		42	2.370	95.00	62.00	9055360023700
0.0937	3/32		2.380	95.00	62.00	9055360023800
0.0945			2.400	95.00	62.00	9055360024000
0.0961		41	2.440	95.00	62.00	9055360024400
0.0980		40	2.490	95.00	62.00	9055360024900
0.0984			2.500	95.00	62.00	9055360025000
0.0996		39	2.530	95.00	62.00	9055360025300
0.1016		38	2.580	95.00	62.00	9055360025800
0.1024			2.600	95.00	62.00	9055360026000
0.1039		37	2.640	95.00	62.00	9055360026400
0.1063			2.700	100.00	66.00	9055360027000
0.1067		36	2.710	100.00	66.00	9055360027100
0.1094	7/64		2.780	100.00	66.00	9055360027800
0.1098		35	2.790	100.00	66.00	9055360027900
0.1102			2.800	100.00	66.00	9055360028000
0.1110		34	2.820	100.00	66.00	9055360028200
0.1130		33	2.870	100.00	66.00	9055360028700
0.1142			2.900	100.00	66.00	9055360029000
0.1161		32	2.950	100.00	66.00	9055360029500
0.1181			3.000	100.00	66.00	9055360030000
0.1201		31	3.050	106.00	69.00	9055360030500

Diameter (d1)		Wire / letter	d2	l1	l2	EDP #
Dec. inch	Fract. inch					
0.1220			3.100	106.00	69.00	9055360031000
0.1248		1/8	3.170	106.00	69.00	9055360031700
0.1260			3.200	106.00	69.00	9055360032000
0.1283		30	3.260	106.00	69.00	9055360032600
0.1299			3.300	106.00	69.00	9055360033000
0.1339			3.400	112.00	73.00	9055360034000
0.1358		29	3.450	112.00	73.00	9055360034500
0.1378			3.500	112.00	73.00	9055360035000
0.1406	9/64		3.570	112.00	73.00	9055360035700
0.1417			3.600	112.00	73.00	9055360036000
0.1441		27	3.660	112.00	73.00	9055360036600
0.1457			3.700	112.00	73.00	9055360037000
0.1469		26	3.730	112.00	73.00	9055360037300
0.1496		25	3.800	119.00	78.00	9055360038000
0.1520		24	3.860	119.00	78.00	9055360038600
0.1535			3.900	119.00	78.00	9055360039000
0.1539		23	3.910	119.00	78.00	9055360039100
0.1563	5/32		3.970	119.00	78.00	9055360039700
0.1571		22	3.990	119.00	78.00	9055360039900
0.1575			4.000	119.00	78.00	9055360040000
0.1591		21	4.040	119.00	78.00	9055360040400
0.1610		20	4.090	119.00	78.00	9055360040900
0.1614			4.100	119.00	78.00	9055360041000
0.1654			4.200	119.00	78.00	9055360042000
0.1661		19	4.220	119.00	78.00	9055360042200
0.1693		18	4.300	126.00	82.00	9055360043000
0.1720	11/64		4.370	126.00	82.00	9055360043700
0.1728		17	4.390	126.00	82.00	9055360043900
0.1732			4.400	126.00	82.00	9055360044000
0.1772		16	4.500	126.00	82.00	9055360045000
0.1799		15	4.570	126.00	82.00	9055360045700
0.1811			4.600	126.00	82.00	9055360046000
0.1819		14	4.620	126.00	82.00	9055360046200
0.1850		13	4.700	126.00	82.00	9055360047000
0.1874	3/16		4.760	132.00	87.00	9055360047600
0.1890		12	4.800	132.00	87.00	9055360048000
0.1909		11	4.850	132.00	87.00	9055360048500
0.1929			4.900	132.00	87.00	9055360049000
0.1937		10	4.920	132.00	87.00	9055360049200
0.1961		9	4.980	132.00	87.00	9055360049800
0.1969			5.000	132.00	87.00	9055360050000
0.1992		8	5.060	132.00	87.00	9055360050600
0.2008			5.100	132.00	87.00	9055360051000
0.2012		7	5.110	132.00	87.00	9055360051100
0.2031	13/64		5.160	132.00	87.00	9055360051600
0.2039		6	5.180	132.00	87.00	9055360051800
0.2047			5.200	132.00	87.00	9055360052000
0.2055		5	5.220	132.00	87.00	9055360052200
0.2087			5.300	132.00	87.00	9055360053000
0.2091		4	5.310	139.00	91.00	9055360053100
0.2126			5.400	139.00	91.00	9055360054000
0.2130		3	5.410	139.00	91.00	9055360054100
0.2165			5.500	139.00	91.00	9055360055000
0.2189	7/32		5.560	139.00	91.00	9055360055600

*Items listed in red are non-stocked items, and may take 2 - 6 weeks to receive

Series 5536

Speeds & Feeds information pg 488

Twist Drills

Diameter (d1)		Wire / letter	d2 mm	l1 mm	l2 mm	EDP #
Dec. inch	Fract. inch					
0.2205			5.600	139.00	91.00	9055360056000
0.2209		2	5.610	139.00	91.00	9055360056100
0.2244			5.700	139.00	91.00	9055360057000
0.2280		1	5.790	139.00	91.00	9055360057900
0.2283			5.800	139.00	91.00	9055360058000
0.2323			5.900	139.00	91.00	9055360059000
0.2339		A	5.940	139.00	91.00	9055360059400
0.2343	15/64		5.950	139.00	91.00	9055360059500
0.2362			6.000	139.00	91.00	9055360060000
0.2378		B	6.040	148.00	97.00	9055360060400
0.2402			6.100	148.00	97.00	9055360061000
0.2421		C	6.150	148.00	97.00	9055360061500
0.2441			6.200	148.00	97.00	9055360062000
0.2461		D	6.250	148.00	97.00	9055360062500
0.2480			6.300	148.00	97.00	9055360063000
0.2500	1/4	E	6.350	148.00	97.00	9055360063500
0.2520			6.400	148.00	97.00	9055360064000
0.2559			6.500	148.00	97.00	9055360065000
0.2571		F	6.530	148.00	97.00	9055360065300
0.2598			6.600	148.00	97.00	9055360066000
0.2610		G	6.630	148.00	97.00	9055360066300
0.2638			6.700	148.00	97.00	9055360067000
0.2657	17/64		6.750	156.00	102.00	9055360067500
0.2677			6.800	156.00	102.00	9055360068000
0.2717		I	6.900	156.00	102.00	9055360069000
0.2756			7.000	156.00	102.00	9055360070000
0.2768		J	7.030	156.00	102.00	9055360070300
0.2795			7.100	156.00	102.00	9055360071000
0.2811	9/32	K	7.140	156.00	102.00	9055360071400
0.2835			7.200	156.00	102.00	9055360072000
0.2874			7.300	156.00	102.00	9055360073000
0.2902		L	7.370	156.00	102.00	9055360073700
0.2913			7.400	156.00	102.00	9055360074000
0.2949		M	7.490	156.00	102.00	9055360074900
0.2953			7.500	156.00	102.00	9055360075000
0.2969	19/64		7.540	165.00	109.00	9055360075400
0.2992			7.600	165.00	109.00	9055360076000
0.3020		N	7.670	165.00	109.00	9055360076700
0.3031			7.700	165.00	109.00	9055360077000
0.3071			7.800	165.00	109.00	9055360078000
0.3110			7.900	165.00	109.00	9055360079000
0.3126	5/16		7.940	165.00	109.00	9055360079400
0.3150			8.000	165.00	109.00	9055360080000
0.3161		O	8.030	165.00	109.00	9055360080300
0.3189			8.100	165.00	109.00	9055360081000
0.3228		P	8.200	165.00	109.00	9055360082000
0.3268			8.300	165.00	109.00	9055360083000
0.3280	21/64		8.330	165.00	109.00	9055360083300
0.3307			8.400	165.00	109.00	9055360084000
0.3319		Q	8.430	165.00	109.00	9055360084300
0.3346			8.500	165.00	109.00	9055360085000
0.3386			8.600	175.00	115.00	9055360086000
0.3390		R	8.610	175.00	115.00	9055360086100
0.3425			8.700	175.00	115.00	9055360087000

Diameter (d1)		Wire / letter	d2 mm	l1 mm	l2 mm	EDP #
Dec. inch	Fract. inch					
0.3437	11/32		8.730	175.00	115.00	9055360087300
0.3465			8.800	175.00	115.00	9055360088000
0.3480		S	8.840	175.00	115.00	9055360088400
0.3504			8.900	175.00	115.00	9055360089000
0.3543			9.000	175.00	115.00	9055360090000
0.3579		T	9.090	175.00	115.00	9055360090900
0.3583			9.100	175.00	115.00	9055360091000
0.3594	23/64		9.130	175.00	115.00	9055360091300
0.3622			9.200	175.00	115.00	9055360092000
0.3661			9.300	175.00	115.00	9055360093000
0.3677		U	9.340	175.00	115.00	9055360093400
0.3701			9.400	175.00	115.00	9055360094000
0.3740			9.500	175.00	115.00	9055360095000
0.3748	3/8		9.520	184.00	121.00	9055360095200
0.3772		V	9.580	184.00	121.00	9055360095800
0.3780			9.600	184.00	121.00	9055360096000
0.3819			9.700	184.00	121.00	9055360097000
0.3858		W	9.800	184.00	121.00	9055360098000
0.3898			9.900	184.00	121.00	9055360099000
0.3906	25/64		9.920	184.00	121.00	9055360099200
0.3937			10.000	184.00	121.00	9055360100000
0.3969		X	10.080	184.00	121.00	9055360100800
0.3976			10.100	184.00	121.00	9055360101000
0.4016			10.200	184.00	121.00	9055360102000
0.4039		Y	10.260	184.00	121.00	9055360102600
0.4055			10.300	184.00	121.00	9055360103000
0.4063	13/32		10.320	184.00	121.00	9055360103200
0.4094			10.400	184.00	121.00	9055360104000
0.4130		Z	10.490	184.00	121.00	9055360104900
0.4134			10.500	184.00	121.00	9055360105000
0.4220	27/64		10.720	195.00	128.00	9055360107200
0.4331			11.000	195.00	128.00	9055360110000
0.4374	7/16		11.110	195.00	128.00	9055360111100
0.4528			11.500	195.00	128.00	9055360115000
0.4531	29/64		11.510	195.00	128.00	9055360115100
0.4689	15/32		11.910	205.00	134.00	9055360119100
0.4724			12.000	205.00	134.00	9055360120000
0.4843	31/64		12.300	205.00	134.00	9055360123000
0.4921			12.500	205.00	134.00	9055360125000
0.5000	1/2		12.700	205.00	134.00	9055360127000
0.5118			13.000	205.00	134.00	9055360130000
0.5157	33/64		13.100	205.00	134.00	9055360131000
0.5311	17/32		13.490	214.00	140.00	9055360134900
0.5315			13.500	214.00	140.00	9055360135000
0.5512			14.000	214.00	140.00	9055360140000
0.5626	9/16		14.290	220.00	144.00	9055360142900

Alternative Drill Series:

#5512 Carbide, RT100, 7xD, 140 U pt, FIREX
#5511 Carbide, FT100T, 20xD, 135 pt, TiAlN tipped

10xD



TiN coated



External Coolant



Straight Shank

Speeds & Feeds
information pg 488

Series 5537

GU 500 DZ High-performance

Cobalt, GU 500 DZ universal, taper length, 118° 4-facet split point,
standard straight shank, RH helix

Cut/Shank Dia. = h8 tolerance range

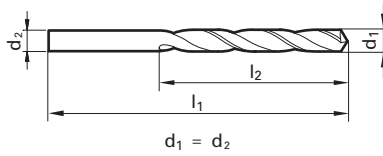

Application Materials:

- General Steels/Brass
- Universal Steels
- Stainless Steels
- Hardened Materials
- Cast Iron

Twist Drills



Dec. inch	Diameter (d1)		l1 mm	l2 mm	EDP #
	Fract. inch	Wire / letter			
0.0394			56.00	33.00	9055370010000
0.0402		60	56.00	33.00	9055370010200
0.0409		59	56.00	33.00	9055370010400
0.0421		58	60.00	37.00	9055370010700
0.0429		57	60.00	37.00	9055370010900
0.0433			60.00	37.00	9055370011000
0.0465		56	60.00	37.00	9055370011800
0.0469	3/64		65.00	41.00	9055370011900
0.0472			65.00	41.00	9055370012000
0.0512			65.00	41.00	9055370013000
0.0520		55	65.00	41.00	9055370013200
0.0551		54	70.00	45.00	9055370014000
0.0591			70.00	45.00	9055370015000
0.0594		53	76.00	50.00	9055370015100
0.0626	1/16		76.00	50.00	9055370015900
0.0630			76.00	50.00	9055370016000
0.0634		52	76.00	50.00	9055370016100
0.0669		51	76.00	50.00	9055370017000
0.0701		50	80.00	53.00	9055370017800
0.0709			80.00	53.00	9055370018000
0.0728		49	80.00	53.00	9055370018500
0.0748			80.00	53.00	9055370019000
0.0760		48	85.00	56.00	9055370019300
0.0780	5/64		85.00	56.00	9055370019800
0.0783		47	85.00	56.00	9055370019900
0.0787			85.00	56.00	9055370020000
0.0811		46	85.00	56.00	9055370020600
0.0819		45	85.00	56.00	9055370020800
0.0827			85.00	56.00	9055370021000
0.0858		44	90.00	59.00	9055370021800
0.0866			90.00	59.00	9055370022000
0.0890		43	90.00	59.00	9055370022600
0.0906			90.00	59.00	9055370023000
0.0933		42	95.00	62.00	9055370023700
0.0937	3/32		95.00	62.00	9055370023800
0.0945			95.00	62.00	9055370024000
0.0961		41	95.00	62.00	9055370024400
0.0980		40	95.00	62.00	9055370024900
0.0984			95.00	62.00	9055370025000
0.0996		39	95.00	62.00	9055370025300
0.1016		38	95.00	62.00	9055370025800
0.1024			95.00	62.00	9055370026000
0.1039		37	95.00	62.00	9055370026400
0.1063			100.00	66.00	9055370027000
0.1067		36	100.00	66.00	9055370027100
0.1094	7/64		100.00	66.00	9055370027800
0.1098		35	100.00	66.00	9055370027900
0.1102			100.00	66.00	9055370028000
0.1110		34	100.00	66.00	9055370028200
0.1130		33	100.00	66.00	9055370028700
0.1142			100.00	66.00	9055370029000
0.1161		32	100.00	66.00	9055370029500
0.1181			100.00	66.00	9055370030000
0.1201		31	106.00	69.00	9055370030500

Dec. inch	Diameter (d1)		l1 mm	l2 mm	EDP #
	Fract. inch	Wire / letter			
0.1220			106.00	69.00	9055370031000
0.1248		1/8	106.00	69.00	9055370031700
0.1260			3.200	106.00	9055370032000
0.1283		30	3.260	106.00	9055370032600
0.1299			3.300	106.00	9055370033000
0.1339			3.400	112.00	9055370034000
0.1358		29	3.450	112.00	9055370034500
0.1378			3.500	112.00	9055370035000
0.1406	9/64		3.570	112.00	9055370035700
0.1417			3.600	112.00	9055370036000
0.1441		27	3.660	112.00	9055370036600
0.1457			3.700	112.00	9055370037000
0.1469		26	3.730	112.00	9055370037300
0.1496		25	3.800	119.00	9055370038000
0.1520		24	3.860	119.00	9055370038600
0.1535			3.900	119.00	9055370039000
0.1539		23	3.910	119.00	9055370039100
0.1563	5/32		3.970	119.00	9055370039700
0.1571		22	3.990	119.00	9055370039900
0.1575			4.000	119.00	9055370040000
0.1591		21	4.040	119.00	9055370040400
0.1610		20	4.090	119.00	9055370040900
0.1614			4.100	119.00	9055370041000
0.1654			4.200	119.00	9055370042000
0.1661		19	4.220	119.00	9055370042200
0.1693		18	4.300	126.00	9055370043000
0.1720	11/64		4.370	126.00	9055370043700
0.1728		17	4.390	126.00	9055370043900
0.1732			4.400	126.00	9055370044000
0.1772		16	4.500	126.00	9055370045000
0.1799		15	4.570	126.00	9055370045700
0.1811			4.600	126.00	9055370046000
0.1819		14	4.620	126.00	9055370046200
0.1850		13	4.700	126.00	9055370047000
0.1874	3/16		4.760	132.00	9055370047600
0.1890		12	4.800	132.00	9055370048000
0.1909		11	4.850	132.00	9055370048500
0.1929			4.900	132.00	9055370049000
0.1937		10	4.920	132.00	9055370049200
0.1961		9	4.980	132.00	9055370049800
0.1969			5.000	132.00	9055370050000
0.1992		8	5.060	132.00	9055370050600
0.2008			5.100	132.00	9055370051000
0.2012		7	5.110	132.00	9055370051100
0.2031	13/64		5.160	132.00	9055370051600
0.2039		6	5.180	132.00	9055370051800
0.2047			5.200	132.00	9055370052000
0.2055		5	5.220	132.00	9055370052200
0.2087			5.300	132.00	9055370053000
0.2091		4	5.310	139.00	9055370053100
0.2126			5.400	139.00	9055370054000
0.2130		3	5.410	139.00	9055370054100
0.2165			5.500	139.00	9055370055000
0.2189	7/32		5.560	139.00	9055370055600

*Items listed in red are non-stocked items, and may take 2 - 6 weeks to receive

Series 5537

Speeds & Feeds information pg 488

Twist Drills

Diameter (d1)						
Dec. inch	Fract. inch	Wire / letter	mm	l1 mm	l2 mm	EDP #
0.2205			5.600	139.00	91.00	9055370056000
0.2209		2	5.610	139.00	91.00	90553700056100
0.2244			5.700	139.00	91.00	9055370057000
0.2280		1	5.790	139.00	91.00	9055370057900
0.2283			5.800	139.00	91.00	9055370058000
0.2323			5.900	139.00	91.00	9055370059000
0.2339		A	5.940	139.00	91.00	9055370059400
0.2343	15/64		5.950	139.00	91.00	9055370059500
0.2362			6.000	139.00	91.00	9055370060000
0.2378		B	6.040	148.00	97.00	9055370060400
0.2402			6.100	148.00	97.00	9055370061000
0.2421		C	6.150	148.00	97.00	9055370061500
0.2441			6.200	148.00	97.00	9055370062000
0.2461		D	6.250	148.00	97.00	9055370062500
0.2480			6.300	148.00	97.00	9055370063000
0.2500	1/4	E	6.350	148.00	97.00	9055370063500
0.2520			6.400	148.00	97.00	9055370064000
0.2559			6.500	148.00	97.00	9055370065000
0.2571		F	6.530	148.00	97.00	9055370065300
0.2598			6.600	148.00	97.00	9055370066000
0.2610		G	6.630	148.00	97.00	9055370066300
0.2638			6.700	148.00	97.00	9055370067000
0.2657	17/64		6.750	156.00	102.00	9055370067500
0.2677			6.800	156.00	102.00	9055370068000
0.2717		I	6.900	156.00	102.00	9055370069000
0.2756			7.000	156.00	102.00	9055370070000
0.2768		J	7.030	156.00	102.00	9055370070300
0.2795			7.100	156.00	102.00	9055370071000
0.2811	9/32	K	7.140	156.00	102.00	9055370071400
0.2835			7.200	156.00	102.00	9055370072000
0.2874			7.300	156.00	102.00	9055370073000
0.2902		L	7.370	156.00	102.00	9055370073700
0.2913			7.400	156.00	102.00	9055370074000
0.2949		M	7.490	156.00	102.00	9055370074900
0.2953			7.500	156.00	102.00	9055370075000
0.2969	19/64		7.540	165.00	109.00	9055370075400
0.2992			7.600	165.00	109.00	9055370076000
0.3020		N	7.670	165.00	109.00	9055370076700
0.3031			7.700	165.00	109.00	9055370077000
0.3071			7.800	165.00	109.00	9055370078000
0.3110			7.900	165.00	109.00	9055370079000
0.3126	5/16		7.940	165.00	109.00	9055370079400
0.3150			8.000	165.00	109.00	9055370080000
0.3161		O	8.030	165.00	109.00	9055370080300
0.3189			8.100	165.00	109.00	9055370081000
0.3228		P	8.200	165.00	109.00	9055370082000
0.3268			8.300	165.00	109.00	9055370083000
0.3280	21/64		8.330	165.00	109.00	9055370083300
0.3307			8.400	165.00	109.00	9055370084000
0.3319		Q	8.430	165.00	109.00	9055370084300
0.3346			8.500	165.00	109.00	9055370085000
0.3386			8.600	175.00	115.00	9055370086000
0.3390		R	8.610	175.00	115.00	9055370086100
0.3425			8.700	175.00	115.00	9055370087000

Diameter (d1)						
Dec. inch	Fract. inch	Wire / letter	mm	l1 mm	l2 mm	EDP #
0.3437	11/32		8.730	175.00	115.00	9055370087300
0.3465			8.800	175.00	115.00	9055370088000
0.3480		S	8.840	175.00	115.00	9055370088400
0.3504			8.900	175.00	115.00	9055370089000
0.3543			9.000	175.00	115.00	9055370090000
0.3579		T	9.090	175.00	115.00	9055370090900
0.3583			9.100	175.00	115.00	9055370091000
0.3594	23/64		9.130	175.00	115.00	9055370091300
0.3622			9.200	175.00	115.00	9055370092000
0.3661			9.300	175.00	115.00	9055370093000
0.3677		U	9.340	175.00	115.00	9055370093400
0.3701			9.400	175.00	115.00	9055370094000
0.3740			9.500	175.00	115.00	9055370095000
0.3748	3/8		9.520	184.00	121.00	9055370095200
0.3772		V	9.580	184.00	121.00	9055370095800
0.3780			9.600	184.00	121.00	9055370096000
0.3819			9.700	184.00	121.00	9055370097000
0.3858		W	9.800	184.00	121.00	9055370098000
0.3898			9.900	184.00	121.00	9055370099000
0.3906	25/64		9.920	184.00	121.00	9055370099200
0.3937			10.000	184.00	121.00	9055370100000
0.3969		X	10.080	184.00	121.00	9055370100800
0.3976			10.100	184.00	121.00	9055370101000
0.4016			10.200	184.00	121.00	9055370102000
0.4039		Y	10.260	184.00	121.00	9055370102600
0.4055			10.300	184.00	121.00	9055370103000
0.4063	13/32		10.320	184.00	121.00	9055370103200
0.4094			10.400	184.00	121.00	9055370104000
0.4130		Z	10.490	184.00	121.00	9055370104900
0.4134			10.500	184.00	121.00	9055370105000
0.4220	27/64		10.720	195.00	128.00	9055370107200
0.4331			11.000	195.00	128.00	9055370110000
0.4374	7/16		11.110	195.00	128.00	9055370111100
0.4528			11.500	195.00	128.00	9055370115000
0.4531	29/64		11.510	195.00	128.00	9055370115100
0.4689	15/32		11.910	205.00	134.00	9055370119100
0.4724			12.000	205.00	134.00	9055370120000
0.4843	31/64		12.300	205.00	134.00	9055370123000
0.4921			12.500	205.00	134.00	9055370125000
0.5000	1/2		12.700	205.00	134.00	9055370127000
0.5118			13.000	205.00	134.00	9055370130000
0.5157	33/64		13.100	205.00	134.00	9055370131000
0.5311	17/32		13.490	214.00	140.00	9055370134900
0.5315			13.500	214.00	140.00	9055370135000
0.5512			14.000	214.00	140.00	9055370140000
0.5626	9/16		14.290	220.00	144.00	9055370142900

Alternative Drill Series:

#617 Cobalt, Type Ti, 10xD, 130 split pt., bright

3xD



FIREX® coated



Coolant Through

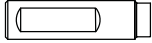

Reinforced Straight Shank w/Flat

Speeds & Feeds information pg 489

Series 5610

RT 100 U High Penetration

Carbide, RT 100 U high penetration, 3xD, self-centering 140° SU point, reinforced shank w/flat, RH helix

Cut Dia. = m7 tolerance range, Shank Dia. = h6

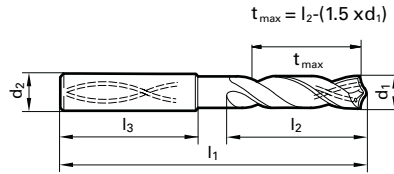

Application Materials:

- General Steels/Brass
- Universal Steels
- Stainless Steels
- Hardened Materials
- Cast Iron
- Ti & Ni Alloys

Twist Drills

* Non-stock item

Diameter (d1)			d2	l1	l2	EDP #
Dec. inch	Fract. inch	Wire / letter	mm	mm	mm	
0.1181			3.00	62.00	20.00	9056100030000
0.1220			3.10	62.00	20.00	9056100031000
0.1248	1/8		3.17	62.00	20.00	9056100031700
0.1260			3.20	62.00	20.00	9056100032000
0.1280			3.25	62.00	20.00	9056100032500
0.1299			3.30	62.00	20.00	9056100033000
0.1339			3.40	62.00	20.00	9056100034000
0.1378			3.50	62.00	20.00	9056100035000
0.1406	9/64		3.57	62.00	20.00	9056100035700
0.1417			3.60	62.00	20.00	9056100036000
0.1457			3.70	62.00	20.00	9056100037000
0.1496		25	3.80	66.00	24.00	9056100038000
0.1535			3.90	66.00	24.00	9056100039000
0.1563	5/32		3.97	66.00	24.00	9056100039700
0.1575			4.00	66.00	24.00	9056100040000
0.1614			4.10	66.00	24.00	9056100041000
0.1654			4.20	66.00	24.00	9056100042000
0.1693		18	4.30	66.00	24.00	9056100043000
0.1720	11/64		4.37	66.00	24.00	9056100043700
0.1732			4.40	66.00	24.00	9056100044000
0.1772		16	4.50	66.00	24.00	9056100045000
0.1811			4.60	66.00	24.00	9056100046000
0.1831			4.65	66.00	24.00	9056100046500
0.1850		13	4.70	66.00	28.00	9056100047000
0.1874	3/16		4.76	66.00	28.00	9056100047600
0.1890			4.80	66.00	28.00	9056100048000
0.1929			4.90	66.00	28.00	9056100049000
0.1969			5.00	66.00	28.00	9056100050000
0.2008			5.10	66.00	28.00	9056100051000
0.2031	13/64		5.16	66.00	28.00	9056100051600
0.2047			5.20	66.00	28.00	9056100052000
0.2087			5.30	66.00	28.00	9056100053000
0.2126			5.40	66.00	28.00	9056100054000
0.2165			5.50	66.00	28.00	9056100055000
0.2185			5.55	66.00	28.00	9056100055500
0.2189	7/32		5.56	66.00	28.00	9056100055600
0.2205			5.60	66.00	28.00	9056100056000
0.2244			5.70	66.00	28.00	9056100057000
0.2264			5.75	66.00	28.00	9056100057500
0.2283			5.80	66.00	28.00	9056100058000
0.2323			5.90	66.00	28.00	9056100059000
0.2343	15/64		5.95	66.00	28.00	9056100059500
0.2362			6.00	66.00	28.00	9056100060000
0.2402			6.10	8.000	34.00	9056100061000
0.2441			6.20	8.000	34.00	9056100062000
0.2480			6.30	8.000	34.00	9056100063000
0.2500	1/4		6.35	8.000	34.00	9056100063500
0.2520			6.40	8.000	34.00	9056100064000
0.2559			6.50	8.000	34.00	9056100065000
0.2598			6.60	8.000	34.00	9056100066000
0.2638			6.70	8.000	34.00	9056100067000
0.2657	17/64		6.75	8.000	34.00	9056100067500
0.2677			6.80	8.000	34.00	9056100068000
0.2717	I		6.90	8.000	34.00	9056100069000

Diameter (d1)			d2	l1	l2	EDP #
Dec. inch	Fract. inch	Wire / letter	mm	mm	mm	
0.2756			7.00	8.000	79.00	9056100070000
0.2795			7.10	8.000	79.00	9056100071000
0.2811	9/32	K	7.14	8.000	79.00	9056100071400
0.2835			7.20	8.000	79.00	9056100072000
0.2874			7.30	8.000	79.00	9056100073000
0.2913			7.40	8.000	79.00	9056100074000
0.2953			7.50	8.000	79.00	9056100075000
0.2969	19/64		7.54	8.000	79.00	9056100075400
0.2992			7.60	8.000	79.00	9056100076000
0.3031			7.70	8.000	79.00	9056100077000
0.3071			7.80	8.000	79.00	9056100078000
0.3110			7.90	8.000	79.00	9056100079000
0.3126	5/16		7.94	8.000	79.00	9056100079400
0.3150			8.00	8.000	79.00	9056100080000
0.3189			8.10	10.000	89.00	9056100081000
0.3228		P	8.20	10.000	89.00	9056100082000
0.3268			8.30	10.000	89.00	9056100083000
0.3280	21/64		8.33	10.000	89.00	9056100083300
0.3307			8.40	10.000	89.00	9056100084000
0.3346			8.50	10.000	89.00	9056100085000
0.3386			8.60	10.000	89.00	9056100086000
0.3425			8.70	10.000	89.00	9056100087000
0.3437	11/32		8.73	10.000	89.00	9056100087300
0.3465			8.80	10.000	89.00	9056100088000
0.3504			8.90	10.000	89.00	9056100089000
0.3543			9.00	10.000	89.00	9056100090000
0.3583			9.10	10.000	89.00	9056100091000
0.3594	23/64		9.13	10.000	89.00	9056100091300
0.3622			9.20	10.000	89.00	9056100092000
0.3642			9.25	10.000	89.00	9056100092500
0.3661			9.30	10.000	89.00	9056100093000
0.3701			9.40	10.000	89.00	9056100094000
0.3740			9.50	10.000	89.00	9056100095000
0.3748	3/8		9.52	10.000	89.00	9056100095200
0.3780			9.60	10.000	89.00	9056100096000
0.3819			9.70	10.000	89.00	9056100097000
0.3858			9.80	10.000	89.00	9056100098000
0.3898			9.90	10.000	89.00	9056100099000
0.3906	25/64		9.92	10.000	89.00	9056100099200
0.3937			10.00	10.000	89.00	9056100100000
0.3976			10.10	12.000	102.00	9056100101000
0.4016			10.20	12.000	102.00	9056100102000
0.4055			10.30	12.000	102.00	9056100103000
0.4063	13/32		10.32	12.000	102.00	9056100103200
0.4094			10.40	12.000	102.00	9056100104000
0.4134			10.50	12.000	102.00	9056100105000
0.4173			10.60	12.000	102.00	9056100106000
0.4213			10.70	12.000	102.00	9056100107000
0.4252			10.80	12.000	102.00	9056100108000
0.4291			10.90	12.000	102.00	9056100109000
0.4331			11.00	12.000	102.00	9056100110000
0.4370			11.10	12.000	102.00	9056100111000
0.4374	7/16		11.11	12.000	102.00	9056100111100
0.4409			11.20	12.000	102.00	9056100112000

*Items listed in red are non-stocked items, and may take 2 - 6 weeks to receive

Series 5610

Speeds & Feeds information pg 489

Diameter (d1)			d2 mm	l1 mm	l2 mm	EDP #	
Dec. inch	Fract. inch	Wire / letter					mm
0.4449			11.30	12.000	102.00	55.00	9056100113000
0.4488			11.40	12.000	102.00	55.00	9056100114000
0.4528			11.50	12.000	102.00	55.00	9056100115000
0.4567			11.60	12.000	102.00	55.00	9056100116000
0.4606			11.70	12.000	102.00	55.00	9056100117000
0.4646			11.80	12.000	102.00	55.00	9056100118000
0.4685			11.90	12.000	102.00	55.00	9056100119000
0.4689	15/32		11.91	12.000	102.00	55.00	9056100119100
0.4724			12.00	12.000	102.00	55.00	9056100120000
0.4764			12.10	14.000	107.00	60.00	9056100121000
0.4803			12.20	14.000	107.00	60.00	9056100122000
0.4921			12.50	14.000	107.00	60.00	9056100125000
0.5000	1/2		12.70	14.000	107.00	60.00	9056100127000
0.5118			13.00	14.000	107.00	60.00	9056100130000
0.5315			13.50	14.000	107.00	60.00	9056100135000
0.5394			13.70	14.000	107.00	60.00	9056100137000
0.5512			14.00	14.000	107.00	60.00	9056100140000
0.5551			14.10	16.000	115.00	65.00	9056100141000
0.5591			14.20	16.000	115.00	65.00	9056100142000
0.5626	9/16		14.29	16.000	115.00	65.00	9056100142900
0.5709			14.50	16.000	115.00	65.00	9056100145000

Diameter (d1)			d2 mm	l1 mm	l2 mm	EDP #	
Dec. inch	Fract. inch	Wire / letter					mm
0.5787			14.70	16.000	115.00	65.00	9056100147000
0.5906			15.00	16.000	115.00	65.00	9056100150000
0.5984			15.20	16.000	115.00	65.00	9056100152000
0.6102			15.50	16.000	115.00	65.00	9056100155000
0.6181			15.70	16.000	115.00	65.00	9056100157000
0.6299			16.00	16.000	115.00	65.00	9056100160000
0.6496			16.50	18.000	123.00	73.00	9056100165000
0.6693			17.00	18.000	123.00	73.00	9056100170000
0.6890			17.50	18.000	123.00	73.00	9056100175000
0.7087			18.00	18.000	123.00	73.00	9056100180000
0.7283			18.50	20.000	131.00	79.00	9056100185000
0.7480			19.00	20.000	131.00	79.00	9056100190000
0.7677			19.50	20.000	131.00	79.00	9056100195000
0.7874			20.00	20.000	131.00	79.00	9056100200000

Alternative Drill Series:

- #5510 Carbide, RT100, 3xD, 140 U pt, FIREX®
- #2477 Carbide, RT100U, 3xD, 140 U pt, nano-FIREX®
- #8510 Carbide, RT100VA, 3xD, 140 VA pt, nano-A

5xD

Series 5611

RT 100 U High Penetration

Carbide, RT 100 U high penetration, 5xD, self-centering
140° SU point, reinforced shank w/flat, RH helix



Cut Dia. = m7 tolerance range, Shank Dia. = h6

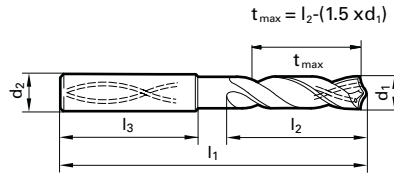

Application Materials:

- General Steels/Brass
- Universal Steels
- Stainless Steels
- Hardened Materials
- Cast Iron
- Ti & Ni Alloys

* Non-stock item

F

FIREX® coated



Coolant Through



Reinforced Straight Shank
w/Flat

Speeds & Feeds
information pg 489

Diameter (d1)			d2 mm	l1 mm	l2 mm	EDP #
Dec. inch	Fract. inch	Wire / letter				
0.1181			3.00	66.00	28.00	9056110030000
0.1220			3.10	66.00	28.00	9056110031000
0.1248	1/8		3.17	66.00	28.00	9056110031700
0.1260			3.20	66.00	28.00	9056110032000
0.1280			3.25	66.00	28.00	9056110032500
0.1299			3.30	66.00	28.00	9056110033000
0.1339			3.40	66.00	28.00	9056110034000
0.1378			3.50	66.00	28.00	9056110035000
0.1406	9/64		3.57	66.00	28.00	9056110035700
0.1417			3.60	66.00	28.00	9056110036000
0.1457			3.70	66.00	28.00	9056110037000
0.1496	25		3.80	74.00	36.00	9056110038000
0.1535			3.90	74.00	36.00	9056110039000
0.1563	5/32		3.97	74.00	36.00	9056110039700
0.1575			4.00	74.00	36.00	9056110040000
0.1614			4.10	74.00	36.00	9056110041000
0.1654			4.20	74.00	36.00	9056110042000
0.1693	18		4.30	74.00	36.00	9056110043000
0.1720	11/64		4.37	74.00	36.00	9056110043700
0.1732			4.40	74.00	36.00	9056110044000
0.1772	16		4.50	74.00	36.00	9056110045000
0.1811			4.60	74.00	36.00	9056110046000
0.1831			4.65	74.00	36.00	9056110046500
0.1850	13		4.70	74.00	36.00	9056110047000
0.1874	3/16		4.76	82.00	44.00	9056110047600
0.1890			4.80	82.00	44.00	9056110048000
0.1929			4.90	82.00	44.00	9056110049000
0.1969			5.00	82.00	44.00	9056110050000
0.2008			5.10	82.00	44.00	9056110051000
0.2031	13/64		5.16	82.00	44.00	9056110051600
0.2047			5.20	82.00	44.00	9056110052000
0.2087			5.30	82.00	44.00	9056110053000
0.2126			5.40	82.00	44.00	9056110054000
0.2165			5.50	82.00	44.00	9056110055000
0.2185			5.55	82.00	44.00	9056110055500
0.2189	7/32		5.56	82.00	44.00	9056110055600
0.2205			5.60	82.00	44.00	9056110056000
0.2244			5.70	82.00	44.00	9056110057000
0.2283			5.80	82.00	44.00	9056110058000
0.2323			5.90	82.00	44.00	9056110059000
0.2343	15/64		5.95	82.00	44.00	9056110059500
0.2362			6.00	82.00	44.00	9056110060000
0.2402			6.10	91.00	53.00	9056110061000
0.2441			6.20	91.00	53.00	9056110062000
0.2480			6.30	91.00	53.00	9056110063000
0.2500	1/4		6.35	91.00	53.00	9056110063500
0.2520			6.40	91.00	53.00	9056110064000
0.2559			6.50	91.00	53.00	9056110065000
0.2598			6.60	91.00	53.00	9056110066000
0.2638			6.70	91.00	53.00	9056110067000
0.2657	17/64		6.75	91.00	53.00	9056110067500
0.2677			6.80	91.00	53.00	9056110068000
0.2717			6.90	91.00	53.00	9056110069000
0.2756			7.00	91.00	53.00	9056110070000

Diameter (d1)			d2 mm	l1 mm	l2 mm	EDP #
Dec. inch	Fract. inch	Wire / letter				
0.2795			7.10	91.00	53.00	9056110071000
0.2811	9/32		7.14	91.00	53.00	9056110071400
0.2835			7.20	91.00	53.00	9056110072000
0.2874			7.30	91.00	53.00	9056110073000
0.2913			7.40	91.00	53.00	9056110074000
0.2953			7.50	91.00	53.00	9056110075000
0.2969	19/64		7.54	91.00	53.00	9056110075400
0.2992			7.60	91.00	53.00	9056110076000
0.3031			7.70	91.00	53.00	9056110077000
0.3071			7.80	91.00	53.00	9056110078000
0.3110			7.90	91.00	53.00	9056110079000
0.3126	5/16		7.94	91.00	53.00	9056110079400
0.3150			8.00	91.00	53.00	9056110080000
0.3189			8.10	103.00	61.00	9056110081000
0.3228	P		8.20	103.00	61.00	9056110082000
0.3268			8.30	103.00	61.00	9056110083000
0.3280	21/64		8.33	103.00	61.00	9056110083300
0.3307			8.40	103.00	61.00	9056110084000
0.3346			8.50	103.00	61.00	9056110085000
0.3386			8.60	103.00	61.00	9056110086000
0.3425			8.70	103.00	61.00	9056110087000
0.3437	11/32		8.73	103.00	61.00	9056110087300
0.3465			8.80	103.00	61.00	9056110088000
0.3504			8.90	103.00	61.00	9056110089000
0.3543			9.00	103.00	61.00	9056110090000
0.3583			9.10	103.00	61.00	9056110091000
0.3594	23/64		9.13	103.00	61.00	9056110091300
0.3622			9.20	103.00	61.00	9056110092000
0.3642			9.25	103.00	61.00	9056110092500
0.3661			9.30	103.00	61.00	9056110093000
0.3701			9.40	103.00	61.00	9056110094000
0.3740			9.50	103.00	61.00	9056110095000
0.3748	3/8		9.52	103.00	61.00	9056110095200
0.3780			9.60	103.00	61.00	9056110096000
0.3819			9.70	103.00	61.00	9056110097000
0.3858	W		9.80	103.00	61.00	9056110098000
0.3898			9.90	103.00	61.00	9056110099000
0.3906	25/64		9.92	103.00	61.00	9056110099200
0.3937			10.00	103.00	61.00	9056110100000
0.3976			10.10	118.00	71.00	9056110101000
0.4016			10.20	118.00	71.00	9056110102000
0.4055			10.30	118.00	71.00	9056110103000
0.4063	13/32		10.32	118.00	71.00	9056110103200
0.4094			10.40	118.00	71.00	9056110104000
0.4134			10.50	118.00	71.00	9056110105000
0.4173			10.60	118.00	71.00	9056110106000
0.4213			10.70	118.00	71.00	9056110107000
0.4252			10.80	118.00	71.00	9056110108000
0.4291			10.90	118.00	71.00	9056110109000
0.4331			11.00	118.00	71.00	9056110110000
0.4370			11.10	118.00	71.00	9056110111000
0.4374	7/16		11.11	118.00	71.00	9056110111100
0.4409			11.20	118.00	71.00	9056110112000
0.4449			11.30	118.00	71.00	9056110113000

*Items listed in red are non-stocked items, and may take 2 - 6 weeks to receive

Series 5611

Speeds & Feeds information pg 489

Diameter (d1)							
Dec. inch	Fract. inch	Wire / letter	mm	d2 mm	l1 mm	l2 mm	EDP #
0.4488			11.40	12.000	118.00	71.00	9056110114000
0.4528			11.50	12.000	118.00	71.00	9056110115000
0.4567			11.60	12.000	118.00	71.00	9056110116000
0.4606			11.70	12.000	118.00	71.00	9056110117000
0.4646			11.80	12.000	118.00	71.00	9056110118000
0.4685			11.90	12.000	118.00	71.00	9056110119000
0.4689	15/32		11.91	12.000	118.00	71.00	9056110119100
0.4724			12.00	12.000	118.00	71.00	9056110120000
0.4764			12.10	14.000	124.00	77.00	9056110121000
0.4803			12.20	14.000	124.00	77.00	9056110122000
0.4921			12.50	14.000	124.00	77.00	9056110125000
0.5000	1/2		12.70	14.000	124.00	77.00	9056110127000
0.5118			13.00	14.000	124.00	77.00	9056110130000
0.5315			13.50	14.000	124.00	77.00	9056110135000
0.5394			13.70	14.000	124.00	77.00	9056110137000
0.5512			14.00	14.000	124.00	77.00	9056110140000
0.5551			14.10	16.000	133.00	83.00	9056110141000
0.5591			14.20	16.000	133.00	83.00	9056110142000
0.5626	9/16		14.29	16.000	133.00	83.00	9056110142900
0.5709			14.50	16.000	133.00	83.00	9056110145000
0.5787			14.70	16.000	133.00	83.00	9056110147000
0.5906			15.00	16.000	133.00	83.00	9056110150000
0.5984			15.20	16.000	133.00	83.00	9056110152000
0.6102			15.50	16.000	133.00	83.00	9056110155000

Diameter (d1)							
Dec. inch	Fract. inch	Wire / letter	mm	d2 mm	l1 mm	l2 mm	EDP #
0.6181			15.70	16.000	133.00	83.00	9056110157000
0.6299			16.00	16.000	133.00	83.00	9056110160000
0.6496			16.50	18.000	143.00	93.00	9056110165000
0.6575			16.70	18.000	143.00	93.00	9056110167000
0.6693			17.00	18.000	143.00	93.00	9056110170000
0.6890			17.50	18.000	143.00	93.00	9056110175000
0.6969			17.70	18.000	143.00	93.00	9056110177000
0.7087			18.00	18.000	143.00	93.00	9056110180000
0.7283			18.50	20.000	153.00	101.00	9056110185000
0.7362			18.70	20.000	153.00	101.00	9056110187000
0.7480			19.00	20.000	153.00	101.00	9056110190000
0.7500	3/4		19.05	20.000	153.00	101.00	9056110190500
0.7677			19.50	20.000	153.00	101.00	9056110195000
0.7756			19.70	20.000	153.00	101.00	9056110197000
0.7874			20.00	20.000	153.00	101.00	9056110200000

Alternative Drill Series:

- #5511 Carbide, RT100, 5xD, 140 U pt, FIREX®
- #2479 Carbide, RT100, 5xD, 140 U pt, nano-FIREX®
- #8511 Carbide, RT100VA, 5xD, 140 VA pt, nano-A

7xD

Series 5612

Application Materials:

Twist Drills



FIREX® coated



Coolant Through



Reinforced Straight Shank w/Flat

Speeds & Feeds information pg 490

RT 100 U High Penetration

Carbide, RT 100 U high penetration, 7xD, self-centering 140° SU point, reinforced shank w/flat, RH helix

Cut Dia. = m7 tolerance range, Shank Dia. = h6

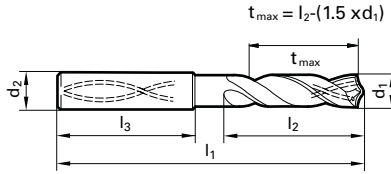

* Non-stock item

Diameter (d1)		Wire / letter	mm	d2 mm	l1 mm	l2 mm	EDP #
Dec. inch	Fract. inch						
0.1181			3.00	6.000	70.00	30.00	9056120030000
0.1220			3.10	6.000	70.00	30.00	9056120031000
0.1248	1/8		3.17	6.000	70.00	30.00	9056120031700
0.1260			3.20	6.000	70.00	30.00	9056120032000
0.1280			3.25	6.000	70.00	30.00	9056120032500
0.1299			3.30	6.000	70.00	30.00	9056120033000
0.1339			3.40	6.000	75.00	37.50	9056120034000
0.1378			3.50	6.000	75.00	37.50	9056120035000
0.1406	9/64		3.57	6.000	75.00	37.50	9056120035700
0.1417			3.60	6.000	75.00	37.50	9056120036000
0.1457			3.70	6.000	75.00	37.50	9056120037000
0.1496		25	3.80	6.000	75.00	37.50	9056120038000
0.1535			3.90	6.000	75.00	37.50	9056120039000
0.1563	5/32		3.97	6.000	75.00	37.50	9056120039700
0.1575			4.00	6.000	75.00	37.50	9056120040000
0.1614			4.10	6.000	75.00	37.50	9056120041000
0.1654			4.20	6.000	75.00	37.50	9056120042000
0.1693		18	4.30	6.000	85.00	45.00	9056120043000
0.1720	11/64		4.37	6.000	85.00	45.00	9056120043700
0.1732			4.40	6.000	85.00	45.00	9056120044000
0.1772		16	4.50	6.000	85.00	45.00	9056120045000
0.1811			4.60	6.000	85.00	45.00	9056120046000
0.1831			4.65	6.000	85.00	45.00	9056120046500
0.1850		13	4.70	6.000	85.00	45.00	9056120047000
0.1874	3/16		4.76	6.000	90.00	50.00	9056120047600
0.1890			4.80	6.000	90.00	50.00	9056120048000
0.1929			4.90	6.000	90.00	50.00	9056120049000
0.1969			5.00	6.000	90.00	50.00	9056120050000
0.2008			5.10	6.000	90.00	50.00	9056120051000
0.2031	13/64		5.16	6.000	90.00	50.00	9056120051600
0.2047			5.20	6.000	90.00	50.00	9056120052000
0.2087			5.30	6.000	90.00	50.00	9056120053000
0.2126			5.40	6.000	90.00	50.00	9056120054000
0.2165			5.50	6.000	97.00	57.00	9056120055000
0.2244			5.70	6.000	97.00	57.00	9056120057000
0.2283			5.80	6.000	97.00	57.00	9056120058000
0.2323			5.90	6.000	97.00	57.00	9056120059000
0.2362			6.00	6.000	97.00	57.00	9056120060000
0.2441			6.20	8.000	106.00	66.00	9056120062000
0.2480			6.30	8.000	106.00	66.00	9056120063000
0.2500	1/4		6.35	8.000	106.00	66.00	9056120063500
0.2559			6.50	8.000	106.00	66.00	9056120065000
0.2598			6.60	8.000	106.00	66.00	9056120066000
0.2638			6.70	8.000	106.00	66.00	9056120067000
0.2677			6.80	8.000	106.00	66.00	9056120068000
0.2717			6.90	8.000	116.00	76.00	9056120069000
0.2756			7.00	8.000	116.00	76.00	9056120070000
0.2795			7.10	8.000	116.00	76.00	9056120071000
0.2835			7.20	8.000	116.00	76.00	9056120072000
0.2913			7.40	8.000	116.00	76.00	9056120074000
0.2953			7.50	8.000	116.00	76.00	9056120075000
0.2992			7.60	8.000	116.00	76.00	9056120076000
0.3031			7.70	8.000	116.00	76.00	9056120077000
0.3071			7.80	8.000	116.00	76.00	9056120078000
0.3150			8.00	8.000	116.00	76.00	9056120080000

Diameter (d1)		Wire / letter	mm	d2 mm	l1 mm	l2 mm	EDP #
Dec. inch	Fract. inch						
0.3189			8.10	10.000	131.00	87.00	9056120081000
0.3228		P	8.20	10.000	131.00	87.00	9056120082000
0.3307			8.40	10.000	131.00	87.00	9056120084000
0.3346			8.50	10.000	131.00	87.00	9056120085000
0.3386			8.60	10.000	131.00	87.00	9056120086000
0.3425			8.70	10.000	131.00	87.00	9056120087000
0.3465			8.80	10.000	131.00	87.00	9056120088000
0.3543			9.00	10.000	131.00	87.00	9056120090000
0.3583			9.10	10.000	131.00	87.00	9056120091000
0.3622			9.20	10.000	139.00	95.00	9056120092000
0.3661			9.30	10.000	139.00	95.00	9056120093000
0.3701			9.40	10.000	139.00	95.00	9056120094000
0.3740			9.50	10.000	139.00	95.00	9056120095000
0.3748	3/8		9.52	10.000	139.00	95.00	9056120095200
0.3819			9.70	10.000	139.00	95.00	9056120097000
0.3858	w		9.80	10.000	139.00	95.00	9056120098000
0.3898			9.90	10.000	139.00	95.00	9056120099000
0.3937			10.00	10.000	139.00	95.00	9056120100000
0.4016			10.20	12.000	155.00	106.00	9056120102000
0.4055			10.30	12.000	155.00	106.00	9056120103000
0.4134			10.50	12.000	155.00	106.00	9056120105000
0.4252			10.80	12.000	155.00	106.00	9056120108000
0.4331			11.00	12.000	155.00	106.00	9056120110000
0.4409			11.20	12.000	163.00	114.00	9056120112000
0.4528			11.50	12.000	163.00	114.00	9056120115000
0.4646			11.80	12.000	163.00	114.00	9056120118000
0.4724			12.00	12.000	163.00	114.00	9056120120000
0.4764			12.10	14.000	182.00	133.00	9056120121000
0.4803			12.20	14.000	182.00	133.00	9056120122000
0.4921			12.50	14.000	182.00	133.00	9056120125000
0.5000	1/2		12.70	14.000	182.00	133.00	9056120127000
0.5118			13.00	14.000	182.00	133.00	9056120130000
0.5315			13.50	14.000	182.00	133.00	9056120135000
0.5512			14.00	14.000	182.00	133.00	9056120140000
0.5551			14.10	16.000	204.00	152.00	9056120141000
0.5591			14.20	16.000	204.00	152.00	9056120142000
0.5709			14.50	16.000	204.00	152.00	9056120145000
0.5906			15.00	16.000	204.00	152.00	9056120150000
0.6102			15.50	16.000	204.00	152.00	9056120155000
0.6299			16.00	16.000	204.00	152.00	9056120160000
0.6496			16.50	18.000	223.00	171.00	9056120165000
0.6693			17.00	18.000	223.00	171.00	9056120170000
0.6890			17.50	18.000	223.00	171.00	9056120175000
0.7087			18.00	18.000	223.00	171.00	9056120180000
0.7283			18.50	20.000	244.00	190.00	9056120185000
0.7480			19.00	20.000	244.00	190.00	9056120190000
0.7500	3/4		19.05	20.000	244.00	190.00	9056120190500
0.7677			19.50	20.000	244.00	190.00	9056120195000
0.7874			20.00	20.000	244.00	190.00	9056120200000

Alternative Drill Series:

- #5512 Carbide, RT100, 7xD, 140 U pt, FIREX®
- #4044 Carbide, RT100X, 7xD, 140 X pt, nano-FIREX®

*Items listed in red are non-stocked items, and may take 2 - 6 weeks to receive

EB 80

Single flute gun drill

Carbide head, steel body, Type G point, standard driver, RH cut

Cut Dia. = h5 tolerance range, Shank Dia. = h6

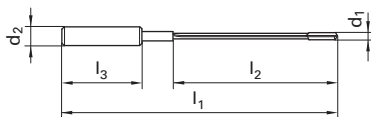

TICN coated



Coolant Through



Reinforced Straight Shank

Speeds & Feeds
information pg 490-491

Application Materials:



General Steels/Brass



Universal Steels



Cast Iron



Aluminum & Alloys

Series 5641 40xD

Diameter (d1)			d2 mm	l1 mm	l2 mm	EDP #	
Dec. inch	Fract. inch	Wire / letter					mm
0.1563	5/32		3.970	10.00	230.00	185.00	9056410039700
0.1575			4.000	10.00	230.00	185.00	9056410040000
0.1969			5.000	16.00	280.00	232.00	9056410050000
0.2030	13/64		5.156	16.00	280.00	232.00	9056410051560
0.2362			6.000	16.00	320.00	272.00	9056410060000
0.2500			6.350	16.00	340.00	292.00	9056410063500
0.2756			7.000	16.00	370.00	322.00	9056410070000
0.3125	5/16		7.938	16.00	430.00	372.00	9056410079380
0.3150			8.000	16.00	430.00	372.00	9056410080000
0.3543			9.000	16.00	450.00	402.00	9056410090000
0.3750	3/8		9.525	16.00	480.00	432.00	9056410095250
0.3937			10.000	20.00	510.00	460.00	9056410100000
0.4331			11.000	20.00	550.00	500.00	9056410110000
0.4375	7/16		11.113	20.00	550.00	500.00	9056410111130
0.4724			12.000	20.00	600.00	550.00	9056410120000
0.5000	1/2		12.700	20.00	635.00	585.00	9056410127000

Series 5642 80xD

Diameter (d1)			d2 mm	l1 mm	l2 mm	EDP #	
Dec. inch	Fract. inch	Wire / letter					mm
0.1949			4.950	16.00	480.00	432.00	9056420049500
0.2010			5.106	16.00	480.00	432.00	9056420051060
0.2343			5.950	16.00	560.00	512.00	9056420059500
0.2480			6.300	16.00	590.00	542.00	9056420063000
0.2736			6.950	16.00	650.00	602.00	9056420069500
0.3106			7.888	16.00	740.00	692.00	9056420078880
0.3130			7.950	16.00	740.00	692.00	9056420079500
0.3524			8.950	16.00	820.00	772.00	9056420089500
0.3730			9.475	16.00	870.00	822.00	9056420094750
0.3917			9.950	20.00	919.00	860.00	9056420099500
0.4311			10.950	20.00	995.00	945.00	9056420109500
0.4356			11.063	20.00	995.00	945.00	9056420110630
0.4705			11.950	20.00	1080.00	1030.00	9056420119500
0.4980			12.650	20.00	1140.00	1090.00	9056420126500

EB 80 standard point grinds

(special point grinds available)

Ø 2.00-4.00 mm

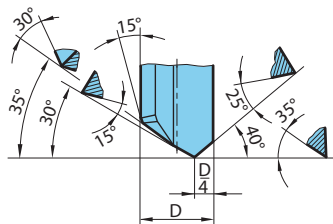

Ø 4.01-20.00 mm

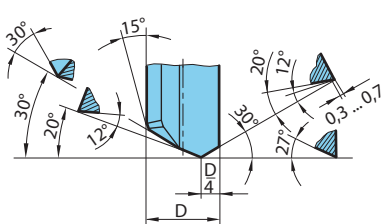

Ø 20.01-40.00 mm

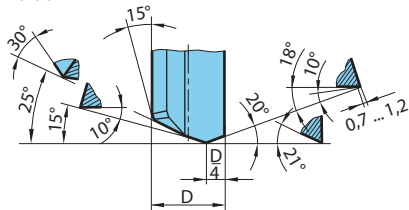

Tech Tip:

Gun drills hold location to precise tolerances in extremely deep hole applications. Conventional gun drills consist of a steel body and driver with a brazed carbide head for extended tool life and performance. When applying standard gun drills some basic steps should be observed:

- Drilling a pilot hole (tol. h8) is advisable. Enter the pilot hole at low RPM and feed rate (example: 200 RPM at 20 in/min)
- Gun drills for drilling depths over 40xD should enter pilot hole in a counterclockwise direction.
- Continuous drilling without pecking is required.
- Switch off coolant supply after reaching maximum drilling depth.
- Use a rapid withdrawal with a stationary spindle.



EB 100

Single flute CNC gun drill

Carbide flute, Type G point, standard driver, RH cut

Cut Dia. = h5 tolerance range, Shank Dia. = h6

Application Materials:

-  General Steels/Brass
-  Universal Steels
-  Cast Iron
-  Aluminum & Alloys

Twist Drills

a

nano-A™ coated



Coolant Through



Reinforced Straight Shank

Speeds & Feeds
information pg 491-492

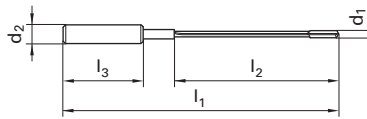

Series 5646 25xD

Diameter (d1)			mm	d2 mm	l1 mm	l2 mm	EDP #
Dec. inch	Fract. inch	Wire / letter					
0.0984			2.500	4.00	115.00	85.00	9056460025000
0.1094	7/64		2.780	4.00	115.00	85.00	9056460027800
0.1181			3.000	6.00	145.00	105.00	9056460030000
0.1248	1/8		3.170	6.00	145.00	105.00	9056460031700
0.1378			3.500	6.00	145.00	105.00	9056460035000
0.1563	5/32		3.970	6.00	160.00	120.00	9056460039700
0.1575			4.000	6.00	160.00	120.00	9056460040000
0.1969			5.000	6.00	220.00	180.00	9056460050000
0.2189	7/32		5.560	6.00	220.00	180.00	9056460055600
0.2362			6.000	6.00	220.00	180.00	9056460060000
0.2500	1/4		6.350	8.00	260.00	210.00	9056460063500
0.2756			7.000	8.00	260.00	210.00	9056460070000
0.2811	9/32	K	7.140	8.00	285.00	240.00	9056460071400
0.3150			8.000	8.00	285.00	240.00	9056460080000
0.3543			9.000	10.00	350.00	300.00	9056460090000
0.3937			10.000	10.00	350.00	300.00	9056460100000
0.4331			11.000	12.00	420.00	360.00	9056460110000
0.4724			12.000	12.00	420.00	360.00	9056460120000

Series 5648 75xD

Diameter (d1)			mm	d2 mm	l1 mm	l2 mm	EDP #
Dec. inch	Fract. inch	Wire / letter					
0.0984			2.500	4.00	255.00	220.00	9056480025000
0.1094	7/64		2.780	4.00	255.00	220.00	9056480027800
0.1181			3.000	6.00	320.00	280.00	9056480030000
0.1248	1/8		3.170	6.00	320.00	280.00	9056480031700
0.1378			3.500	6.00	320.00	280.00	9056480035000
0.1563	5/32		3.970	6.00	360.00	320.00	9056480039700
0.1575			4.000	6.00	360.00	320.00	9056480040000
0.1969			5.000	6.00	525.00	485.00	9056480050000
0.2189	7/32		5.560	6.00	525.00	485.00	9056480055600
0.2362			6.000	6.00	525.00	485.00	9056480060000

Series 5647 50xD

Diameter (d1)			mm	d2 mm	l1 mm	l2 mm	EDP #
Dec. inch	Fract. inch	Wire / letter					
0.0937	3/32		2.380	4.00	160.00	130.00	9056470023800
0.0984			2.500	4.00	185.00	155.00	9056470025000
0.1094	7/64		2.780	4.00	185.00	155.00	9056470027800
0.1181			3.000	6.00	230.00	190.00	9056470030000
0.1248	1/8		3.170	6.00	230.00	190.00	9056470031700
0.1378			3.500	6.00	230.00	190.00	9056470035000
0.1563	5/32		3.970	6.00	260.00	220.00	9056470039700
0.1575			4.000	6.00	260.00	220.00	9056470040000
0.1969			5.000	6.00	370.00	330.00	9056470050000
0.2189	7/32		5.560	6.00	370.00	330.00	9056470055600
0.2362			6.000	6.00	370.00	330.00	9056470060000
0.2500	1/4		6.350	8.00	430.00	385.00	9056470063500
0.2756			7.000	8.00	430.00	385.00	9056470070000
0.2811	9/32	K	7.140	8.00	485.00	440.00	9056470071400
0.3150			8.000	8.00	485.00	440.00	9056470080000

EB 100

Standard point grinds

(special point grinds on request)

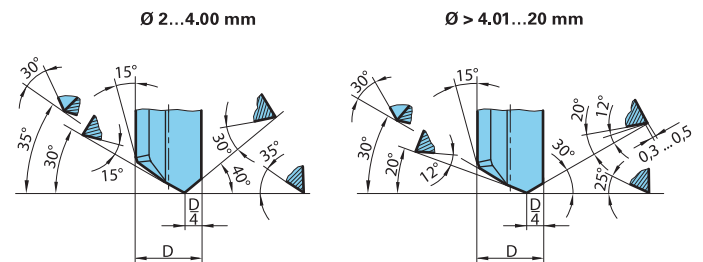

EB 100

1:800 (standard)

Back taper ratio

(dimensions in mm)

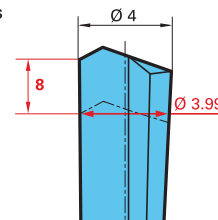

*Items listed in red are non-stocked items, and may take 2 - 6 weeks to receive

3xD

Series 5741

Application Materials:

- Stainless Steels
- Hardened Materials
- Ti & Ni Alloys

RT 100 US High Penetration

Carbide, RT 100 US high penetration, 3xD, self-centering
140° SU point, reinforced straight shank, RH helix



nano-A™ coated



External Coolant



Reinforced Straight Shank

Cut Dia. = m7 tolerance range, Shank Dia. = h6

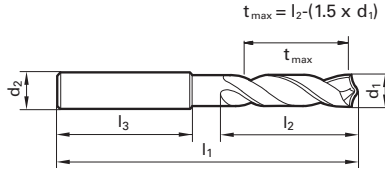

Speeds & Feeds
information pg 493

Diameter (d1)				d2	l1	l2	EDP #
Dec. inch	Fract. inch	Wire / letter	mm				
0.1181			3.000	6.00	62.00	20.00	9057410030000
0.1220			3.100	6.00	62.00	20.00	9057410031000
0.1248	1/8		3.170	6.00	62.00	20.00	9057410031700
0.1260			3.200	6.00	62.00	20.00	9057410032000
0.1280			3.250	6.00	62.00	20.00	9057410032500
0.1299			3.300	6.00	62.00	20.00	9057410033000
0.1339			3.400	6.00	62.00	20.00	9057410034000
0.1378			3.500	6.00	62.00	20.00	9057410035000
0.1406		28	3.570	6.00	62.00	20.00	9057410035700
0.1417			3.600	6.00	62.00	20.00	9057410036000
0.1457			3.700	6.00	62.00	20.00	9057410037000
0.1496		25	3.800	6.00	66.00	24.00	9057410038000
0.1535			3.900	6.00	66.00	24.00	9057410039000
0.1563	5/32		3.970	6.00	66.00	24.00	9057410039700
0.1575			4.000	6.00	66.00	24.00	9057410040000
0.1614			4.100	6.00	66.00	24.00	9057410041000
0.1654			4.200	6.00	66.00	24.00	9057410042000
0.1693		18	4.300	6.00	66.00	24.00	9057410043000
0.1720	11/64		4.370	6.00	66.00	24.00	9057410043700
0.1732			4.400	6.00	66.00	24.00	9057410044000
0.1772		16	4.500	6.00	66.00	24.00	9057410045000
0.1811			4.600	6.00	66.00	24.00	9057410046000
0.1831			4.650	6.00	66.00	24.00	9057410046500
0.1850		13	4.700	6.00	66.00	24.00	9057410047000
0.1874	3/16		4.760	6.00	66.00	28.00	9057410047600
0.1890		12	4.800	6.00	66.00	28.00	9057410048000
0.1929			4.900	6.00	66.00	28.00	9057410049000
0.1969			5.000	6.00	66.00	28.00	9057410050000
0.2008			5.100	6.00	66.00	28.00	9057410051000
0.2031	13/64		5.160	6.00	66.00	28.00	9057410051600
0.2047			5.200	6.00	66.00	28.00	9057410052000
0.2087			5.300	6.00	66.00	28.00	9057410053000
0.2126			5.400	6.00	66.00	28.00	9057410054000
0.2165			5.500	6.00	66.00	28.00	9057410055000
0.2185			5.550	6.00	66.00	28.00	9057410055500
0.2189	7/32		5.560	6.00	66.00	28.00	9057410055600
0.2205			5.600	6.00	66.00	28.00	9057410056000
0.2244			5.700	6.00	66.00	28.00	9057410057000
0.2283			5.800	6.00	66.00	28.00	9057410058000
0.2323			5.900	6.00	66.00	28.00	9057410059000
0.2343	15/64		5.950	6.00	66.00	28.00	9057410059500
0.2362			6.000	6.00	66.00	28.00	9057410060000
0.2402			6.100	8.00	79.00	34.00	9057410061000
0.2441			6.200	8.00	79.00	34.00	9057410062000
0.2480			6.300	8.00	79.00	34.00	9057410063000
0.2500	1/4	E	6.350	8.00	79.00	34.00	9057410063500
0.2520			6.400	8.00	79.00	34.00	9057410064000
0.2559			6.500	8.00	79.00	34.00	9057410065000
0.2598			6.600	8.00	79.00	34.00	9057410066000
0.2638			6.700	8.00	79.00	34.00	9057410067000
0.2657	17/64	H	6.750	8.00	79.00	34.00	9057410067500
0.2677			6.800	8.00	79.00	34.00	9057410068000
0.2717		I	6.900	8.00	79.00	34.00	9057410069000
0.2756			7.000	8.00	79.00	34.00	9057410070000

Diameter (d1)				d2	l1	l2	EDP #
Dec. inch	Fract. inch	Wire / letter	mm				
0.2795			7.100	8.00	79.00	34.00	9057410071000
0.2811	9/32	K	7.140	8.00	79.00	41.00	9057410071400
0.2835			7.200	8.00	79.00	41.00	9057410072000
0.2874			7.300	8.00	79.00	41.00	9057410073000
0.2913			7.400	8.00	79.00	41.00	9057410074000
0.2953			7.500	8.00	79.00	41.00	9057410075000
0.2969	19/64		7.540	8.00	79.00	41.00	9057410075400
0.2992			7.600	8.00	79.00	41.00	9057410076000
0.3031			7.700	8.00	79.00	41.00	9057410077000
0.3071			7.800	8.00	79.00	41.00	9057410078000
0.3110			7.900	8.00	79.00	41.00	9057410079000
0.3126	5/16		7.940	8.00	79.00	41.00	9057410079400
0.3150			8.000	8.00	79.00	41.00	9057410080000
0.3189			8.100	10.00	89.00	47.00	9057410081000
0.3228		P	8.200	10.00	89.00	47.00	9057410082000
0.3268			8.300	10.00	89.00	47.00	9057410083000
0.3280	21/64		8.330	10.00	89.00	47.00	9057410083300
0.3307			8.400	10.00	89.00	47.00	9057410084000
0.3346			8.500	10.00	89.00	47.00	9057410085000
0.3386			8.600	10.00	89.00	47.00	9057410086000
0.3425			8.700	10.00	89.00	47.00	9057410087000
0.3437	11/32		8.730	10.00	89.00	47.00	9057410087300
0.3465			8.800	10.00	89.00	47.00	9057410088000
0.3504			8.900	10.00	89.00	47.00	9057410089000
0.3543			9.000	10.00	89.00	47.00	9057410090000
0.3583			9.100	10.00	89.00	47.00	9057410091000
0.3594	23/64		9.130	10.00	89.00	47.00	9057410091300
0.3622			9.200	10.00	89.00	47.00	9057410092000
0.3642			9.250	10.00	89.00	47.00	9057410092500
0.3661			9.300	10.00	89.00	47.00	9057410093000
0.3701			9.400	10.00	89.00	47.00	9057410094000
0.3740			9.500	10.00	89.00	47.00	9057410095000
0.3748	3/8		9.520	10.00	89.00	47.00	9057410095200
0.3780			9.600	10.00	89.00	47.00	9057410096000
0.3819			9.700	10.00	89.00	47.00	9057410097000
0.3858		W	9.800	10.00	89.00	47.00	9057410098000
0.3898			9.900	10.00	89.00	47.00	9057410099000
0.3906	25/64		9.920	10.00	89.00	47.00	9057410099200
0.3937			10.000	10.00	89.00	47.00	9057410100000
0.3976			10.100	12.00	102.00	55.00	9057410101000
0.4016			10.200	12.00	102.00	55.00	9057410102000
0.4055			10.300	12.00	102.00	55.00	9057410103000
0.4063	13/32		10.320	12.00	102.00	55.00	9057410103200
0.4094			10.400	12.00	102.00	55.00	9057410104000
0.4134			10.500	12.00	102.00	55.00	9057410105000
0.4173			10.600	12.00	102.00	55.00	9057410106000
0.4220	27/64		10.720	12.00	102.00	55.00	9057410107200
0.4252			10.800	12.00	102.00	55.00	9057410108000
0.4291			10.900	12.00	102.00	55.00	9057410109000
0.4331			11.000	12.00	102.00	55.00	9057410110000
0.4370			11.100	12.00	102.00	55.00	9057410111000
0.4374	7/16		11.110	12.00	102.00	55.00	9057410111100
0.4409			11.200	12.00	102.00	55.00	9057410112000
0.4449			11.300	12.00	102.00	55.00	9057410113000

Series 5741

Speeds & Feeds information pg 493

Diameter (d1)			mm	d2 mm	l1 mm	l2 mm	EDP #
Dec. inch	Fract. inch	Wire / letter					
0.4488			11.400	12.00	102.00	55.00	9057410114000
0.4528			11.500	12.00	102.00	55.00	9057410115000
0.4531	29/64		11.510	12.00	102.00	55.00	9057410115100
0.4567			11.600	12.00	102.00	55.00	9057410116000
0.4606			11.700	12.00	102.00	55.00	9057410117000
0.4646			11.800	12.00	102.00	55.00	9057410118000
0.4685			11.900	12.00	102.00	55.00	9057410119000
0.4689	15/32		11.910	12.00	102.00	55.00	9057410119100
0.4724			12.000	12.00	102.00	55.00	9057410120000
0.4764			12.100	14.00	107.00	60.00	9057410121000
0.4803			12.200	14.00	107.00	60.00	9057410122000

Diameter (d1)			mm	d2 mm	l1 mm	l2 mm	EDP #
Dec. inch	Fract. inch	Wire / letter					
0.4843	31/64		12.300	14.00	107.00	60.00	9057410123000
0.4882			12.400	14.00	107.00	60.00	9057410124000
0.4921			12.500	14.00	107.00	60.00	9057410125000
0.4961			12.600	14.00	107.00	60.00	9057410126000
0.5000	1/2		12.700	14.00	107.00	60.00	9057410127000

Alternative Drill Series:
#5514 Carbide, RT100, 3xD, 140 U pt, FIREX®

*Items listed in red are non-stocked items, and may take 2 - 6 weeks to receive

5xD**Series 5744****Application Materials:****Twist Drills****a**

nano-A™ coated



Coolant Through



Reinforced Straight Shank

Speeds & Feeds
information pg 493**RT 100 US High Penetration**Carbide, RT 100 US high penetration, 5xD, self-centering
140° SU point, reinforced straight shank, RH helix

Cut Dia. = m7 tolerance range, Shank Dia. = h6

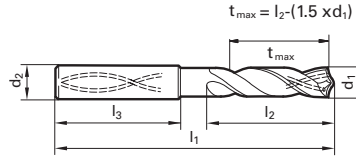

- Stainless Steels
- Hardened Materials
- Ti & Ni Alloys

Dec. inch	Diameter (d1)		d2 mm	l1 mm	l2 mm	EDP #	
	Fract. inch	Wire / letter					mm
0.1181			3.000	6.00	66.00	28.00	9057440030000
0.1220			3.100	6.00	66.00	28.00	9057440031000
0.1248	1/8		3.170	6.00	66.00	28.00	9057440031700
0.1260			3.200	6.00	66.00	28.00	9057440032000
0.1280			3.250	6.00	66.00	28.00	9057440032500
0.1299			3.300	6.00	66.00	28.00	9057440033000
0.1339			3.400	6.00	66.00	28.00	9057440034000
0.1378			3.500	6.00	66.00	28.00	9057440035000
0.1406	9/64	28	3.570	6.00	66.00	28.00	9057440035700
0.1417			3.600	6.00	66.00	28.00	9057440036000
0.1457			3.700	6.00	66.00	28.00	9057440037000
0.1496		25	3.800	6.00	74.00	36.00	9057440038000
0.1535			3.900	6.00	74.00	36.00	9057440039000
0.1563	5/32		3.970	6.00	74.00	36.00	9057440039700
0.1575			4.000	6.00	74.00	36.00	9057440040000
0.1614			4.100	6.00	74.00	36.00	9057440041000
0.1654			4.200	6.00	74.00	36.00	9057440042000
0.1693		18	4.300	6.00	74.00	36.00	9057440043000
0.1720	11/64		4.370	6.00	74.00	36.00	9057440043700
0.1732			4.400	6.00	74.00	36.00	9057440044000
0.1772		16	4.500	6.00	74.00	36.00	9057440045000
0.1811			4.600	6.00	74.00	36.00	9057440046000
0.1831			4.650	6.00	74.00	36.00	9057440046500
0.1850		13	4.700	6.00	74.00	36.00	9057440047000
0.1874	3/16		4.760	6.00	82.00	44.00	9057440047600
0.1890		12	4.800	6.00	82.00	44.00	9057440048000
0.1929			4.900	6.00	82.00	44.00	9057440049000
0.1969			5.000	6.00	82.00	44.00	9057440050000
0.2008			5.100	6.00	82.00	44.00	9057440051000
0.2031	13/64		5.160	6.00	82.00	44.00	9057440051600
0.2047			5.200	6.00	82.00	44.00	9057440052000
0.2087			5.300	6.00	82.00	44.00	9057440053000
0.2126			5.400	6.00	82.00	44.00	9057440054000
0.2165			5.500	6.00	82.00	44.00	9057440055000
0.2185			5.550	6.00	82.00	44.00	9057440055500
0.2189	7/32		5.560	6.00	82.00	44.00	9057440055600
0.2205			5.600	6.00	82.00	44.00	9057440056000
0.2244			5.700	6.00	82.00	44.00	9057440057000
0.2283			5.800	6.00	82.00	44.00	9057440058000
0.2323			5.900	6.00	82.00	44.00	9057440059000
0.2343	15/64		5.950	6.00	82.00	44.00	9057440059500
0.2362			6.000	6.00	82.00	44.00	9057440060000
0.2402			6.100	8.00	91.00	53.00	9057440061000
0.2441			6.200	8.00	91.00	53.00	9057440062000
0.2480			6.300	8.00	91.00	53.00	9057440063000
0.2500	1/4	E	6.350	8.00	91.00	53.00	9057440063500
0.2520			6.400	8.00	91.00	53.00	9057440064000
0.2559			6.500	8.00	91.00	53.00	9057440065000
0.2571		F	6.530	8.00	91.00	53.00	9057440065300
0.2598			6.600	8.00	91.00	53.00	9057440066000
0.2638			6.700	8.00	91.00	53.00	9057440067000
0.2657	17/64	H	6.750	8.00	91.00	53.00	9057440067500
0.2677			6.800	8.00	91.00	53.00	9057440068000
0.2717		I	6.900	8.00	91.00	53.00	9057440069000

Dec. inch	Diameter (d1)		d2 mm	l1 mm	l2 mm	EDP #	
	Fract. inch	Wire / letter					mm
0.2756			7.000	8.00	91.00	53.00	9057440070000
0.2795			7.100	8.00	91.00	53.00	9057440071000
0.2811	9/32	K	7.140	8.00	91.00	53.00	9057440071400
0.2835			7.200	8.00	91.00	53.00	9057440072000
0.2874			7.300	8.00	91.00	53.00	9057440073000
0.2913			7.400	8.00	91.00	53.00	9057440074000
0.2953			7.500	8.00	91.00	53.00	9057440075000
0.2969	19/64		7.540	8.00	91.00	53.00	9057440075400
0.2992			7.600	8.00	91.00	53.00	9057440076000
0.3031			7.700	8.00	91.00	53.00	9057440077000
0.3071			7.800	8.00	91.00	53.00	9057440078000
0.3110			7.900	8.00	91.00	53.00	9057440079000
0.3126	5/16		7.940	8.00	91.00	53.00	9057440079400
0.3150			8.000	8.00	91.00	53.00	9057440080000
0.3189			8.100	10.00	103.00	61.00	9057440081000
0.3228		P	8.200	10.00	103.00	61.00	9057440082000
0.3268			8.300	10.00	103.00	61.00	9057440083000
0.3280	21/64		8.330	10.00	103.00	61.00	9057440083300
0.3307			8.400	10.00	103.00	61.00	9057440084000
0.3346			8.500	10.00	103.00	61.00	9057440085000
0.3386			8.600	10.00	103.00	61.00	9057440086000
0.3425			8.700	10.00	103.00	61.00	9057440087000
0.3437	11/32		8.730	10.00	103.00	61.00	9057440087300
0.3465			8.800	10.00	103.00	61.00	9057440088000
0.3504			8.900	10.00	103.00	61.00	9057440089000
0.3543			9.000	10.00	103.00	61.00	9057440090000
0.3583			9.100	10.00	103.00	61.00	9057440091000
0.3594	23/64		9.130	10.00	103.00	61.00	9057440091300
0.3622			9.200	10.00	103.00	61.00	9057440092000
0.3642			9.250	10.00	103.00	61.00	9057440092500
0.3661			9.300	10.00	103.00	61.00	9057440093000
0.3701			9.400	10.00	103.00	61.00	9057440094000
0.3740			9.500	10.00	103.00	61.00	9057440095000
0.3748	3/8		9.520	10.00	103.00	61.00	9057440095200
0.3780			9.600	10.00	103.00	61.00	9057440096000
0.3819			9.700	10.00	103.00	61.00	9057440097000
0.3858		W	9.800	10.00	103.00	61.00	9057440098000
0.3898			9.900	10.00	103.00	61.00	9057440099000
0.3906	25/64		9.920	10.00	103.00	61.00	9057440099200
0.3937			10.000	10.00	103.00	61.00	9057440100000
0.3976			10.100	12.00	118.00	71.00	9057440101000
0.4016			10.200	12.00	118.00	71.00	9057440102000
0.4055			10.300	12.00	118.00	71.00	9057440103000
0.4063	13/32		10.320	12.00	118.00	71.00	9057440103200
0.4094			10.400	12.00	118.00	71.00	9057440104000
0.4134			10.500	12.00	118.00	71.00	9057440105000
0.4173			10.600	12.00	118.00	71.00	9057440106000
0.4213			10.700	12.00	118.00	71.00	9057440107000
0.4220	27/64		10.720	12.00	118.00	71.00	9057440107200
0.4252			10.800	12.00	118.00	71.00	9057440108000
0.4291			10.900	12.00	118.00	71.00	9057440109000
0.4331			11.000	12.00	118.00	71.00	9057440110000
0.4370			11.100	12.00	118.00	71.00	9057440111000
0.4374	7/16		11.110	12.00	118.00	71.00	9057440111100

Series 5744

Speeds & Feeds information pg 493

Twist Drills

Diameter (d1)							
Dec. inch	Fract. inch	Wire / letter	mm	d2 mm	l1 mm	l2 mm	EDP #
0.4409			11.200	12.00	118.00	71.00	9057440112000
0.4449			11.300	12.00	118.00	71.00	9057440113000
0.4488			11.400	12.00	118.00	71.00	9057440114000
0.4528			11.500	12.00	118.00	71.00	9057440115000
0.4567			11.600	12.00	118.00	71.00	9057440116000
0.4606			11.700	12.00	118.00	71.00	9057440117000
0.4646			11.800	12.00	118.00	71.00	9057440118000
0.4685			11.900	12.00	118.00	71.00	9057440119000
0.4689	15/32		11.910	12.00	118.00	71.00	9057440119100
0.4724			12.000	12.00	118.00	71.00	9057440120000
0.4764			12.100	14.00	124.00	77.00	9057440121000

Diameter (d1)							
Dec. inch	Fract. inch	Wire / letter	mm	d2 mm	l1 mm	l2 mm	EDP #
0.4803			12.200	14.00	124.00	77.00	9057440122000
0.4843	31/64		12.300	14.00	124.00	77.00	9057440123000
0.4882			12.400	14.00	124.00	77.00	9057440124000
0.4921			12.500	14.00	124.00	77.00	9057440125000
0.4961			12.600	14.00	124.00	77.00	9057440126000
0.5000	1/2		12.700	14.00	124.00	77.00	9057440127000

Alternative Drill Series:							
#5510 Carbide, RT100, 3xD, 140 U pt., FIREX®							

*Items listed in red are non-stocked items, and may take 2 - 6 weeks to receive

7xD

Series 5746

Application Materials:

- Stainless Steels
- Hardened Materials
- Ti & Ni Alloys

Twist Drills

a

nano-A™ coated



Coolant Through



Reinforced Straight Shank

Speeds & Feeds
information pg 494

RT 100 US High Penetration

Carbide, RT 100 US high penetration, 7xD, self-centering
140° SU point, reinforced straight shank, RH helix

Cut Dia. = m7 tolerance range, Shank Dia. = h6

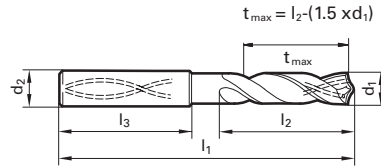

Diameter (d1)			d2	l1	l2	EDP #	
Dec. inch	Fract. inch	Wire / letter					mm
0.1181			3.000	6.00	70.00	30.00	9057460030000
0.1220			3.100	6.00	70.00	30.00	9057460031000
0.1248	1/8		3.170	6.00	70.00	30.00	9057460031700
0.1260			3.200	6.00	70.00	30.00	9057460032000
0.1299			3.300	6.00	70.00	30.00	9057460033000
0.1339			3.400	6.00	75.00	37.50	9057460034000
0.1378			3.500	6.00	75.00	37.50	9057460035000
0.1406	9/64	28	3.570	6.00	75.00	37.50	9057460035700
0.1417			3.600	6.00	75.00	37.50	9057460036000
0.1457			3.700	6.00	75.00	37.50	9057460037000
0.1496		25	3.800	6.00	75.00	37.50	9057460038000
0.1535			3.900	6.00	75.00	37.50	9057460039000
0.1563	5/32		3.970	6.00	75.00	37.50	9057460039700
0.1575			4.000	6.00	75.00	37.50	9057460040000
0.1614			4.100	6.00	75.00	37.50	9057460041000
0.1654			4.200	6.00	75.00	37.50	9057460042000
0.1693			4.300	6.00	85.00	45.00	9057460043000
0.1720	11/64		4.370	6.00	85.00	45.00	9057460043700
0.1732			4.400	6.00	85.00	45.00	9057460044000
0.1772			4.500	6.00	85.00	45.00	9057460045000
0.1811			4.600	6.00	85.00	45.00	9057460046000
0.1830			4.650	6.00	85.00	45.00	9057460046500
0.1850			4.700	6.00	85.00	45.00	9057460047000
0.1874	3/16		4.760	6.00	90.00	50.00	9057460047600
0.1890			4.800	6.00	90.00	50.00	9057460048000
0.1929			4.900	6.00	90.00	50.00	9057460049000
0.1969			5.000	6.00	90.00	50.00	9057460050000
0.2008			5.100	6.00	90.00	50.00	9057460051000
0.2031	13/64		5.160	6.00	90.00	50.00	9057460051600
0.2047			5.200	6.00	90.00	50.00	9057460052000
0.2087			5.300	6.00	90.00	50.00	9057460053000
0.2126			5.400	6.00	90.00	50.00	9057460054000
0.2165			5.500	6.00	97.00	57.00	9057460055000
0.2189	7/32		5.560	6.00	97.00	57.00	9057460055600
0.2244			5.700	6.00	97.00	57.00	9057460057000
0.2283			5.800	6.00	97.00	57.00	9057460058000
0.2323			5.900	6.00	97.00	57.00	9057460059000
0.2343	15/64		5.950	6.00	97.00	57.00	9057460059500
0.2362			6.000	6.00	97.00	57.00	9057460060000
0.2402			6.100	8.00	106.00	66.00	9057460061000
0.2441			6.200	8.00	106.00	66.00	9057460062000
0.2480			6.300	8.00	106.00	66.00	9057460063000
0.2500	1/4	E	6.350	8.00	106.00	66.00	9057460063500
0.2559			6.500	8.00	106.00	66.00	9057460065000
0.2571		F	6.530	8.00	106.00	66.00	9057460065300
0.2598			6.600	8.00	106.00	66.00	9057460066000
0.2638			6.700	8.00	106.00	66.00	9057460067000
0.2657	17/64	H	6.750	8.00	106.00	66.00	9057460067500
0.2677			6.800	8.00	106.00	66.00	9057460068000
0.2717		I	6.900	8.00	116.00	76.00	9057460069000
0.2756			7.000	8.00	116.00	76.00	9057460070000
0.2795			7.100	8.00	116.00	76.00	9057460071000
0.2811	9/32	K	7.140	8.00	116.00	76.00	9057460071400
0.2835			7.200	8.00	116.00	76.00	9057460072000

Diameter (d1)			d2	l1	l2	EDP #	
Dec. inch	Fract. inch	Wire / letter					mm
0.2874			7.300	8.00	116.00	76.00	9057460073000
0.2913			7.400	8.00	116.00	76.00	9057460074000
0.2953			7.500	8.00	116.00	76.00	9057460075000
0.2969	19/64		7.540	8.00	116.00	76.00	9057460075400
0.2992			7.600	8.00	116.00	76.00	9057460076000
0.3031			7.700	8.00	116.00	76.00	9057460077000
0.3071			7.800	8.00	116.00	76.00	9057460078000
0.3126	5/16		7.940	8.00	116.00	76.00	9057460079400
0.3150			8.000	8.00	116.00	76.00	9057460080000
0.3189			8.100	10.00	131.00	87.00	9057460081000
0.3228		P	8.200	10.00	131.00	87.00	9057460082000
0.3280	21/64		8.330	10.00	131.00	87.00	9057460083300
0.3307			8.400	10.00	131.00	87.00	9057460084000
0.3346			8.500	10.00	131.00	87.00	9057460085000
0.3386			8.600	10.00	131.00	87.00	9057460086000
0.3425			8.700	10.00	131.00	87.00	9057460087000
0.3437	11/32		8.730	10.00	131.00	87.00	9057460087300
0.3465			8.800	10.00	131.00	87.00	9057460088000
0.3543			9.000	10.00	131.00	87.00	9057460090000
0.3583			9.100	10.00	139.00	95.00	9057460091000
0.3594	23/64		9.130	10.00	139.00	95.00	9057460091300
0.3622			9.200	10.00	139.00	95.00	9057460092000
0.3661			9.300	10.00	139.00	95.00	9057460093000
0.3701			9.400	10.00	139.00	95.00	9057460094000
0.3740			9.500	10.00	139.00	95.00	9057460095000
0.3748	3/8		9.520	10.00	139.00	95.00	9057460095200
0.3819			9.700	10.00	139.00	95.00	9057460097000
0.3858		W	9.800	10.00	139.00	95.00	9057460098000
0.3898			9.900	10.00	139.00	95.00	9057460099000
0.3906	25/64		9.920	10.00	139.00	95.00	9057460099200
0.3937			10.000	10.00	139.00	95.00	9057460100000
0.3937			10.200	12.00	155.00	106.00	9057460102000
0.4055			10.300	12.00	155.00	106.00	9057460103000
0.4063	13/32		10.320	12.00	155.00	106.00	9057460103200
0.4134			10.500	12.00	155.00	106.00	9057460105000
0.4220	27/64		10.720	12.00	155.00	106.00	9057460107200
0.4252			10.800	12.00	155.00	106.00	9057460108000
0.4331			11.000	12.00	155.00	106.00	9057460110000
0.4374	7/16		11.110	12.00	163.00	114.00	9057460111100
0.4409			11.200	12.00	163.00	114.00	9057460112000
0.4528			11.500	12.00	163.00	114.00	9057460115000
0.4646			11.800	12.00	163.00	114.00	9057460118000
0.4689	29/64		11.910	12.00	163.00	114.00	9057460119100
0.4724			12.000	12.00	163.00	114.00	9057460120000
0.4764			12.100	14.00	182.00	133.00	9057460121000
0.4803			12.200	14.00	182.00	133.00	9057460122000
0.4843	31/64		12.300	14.00	182.00	133.00	9057460123000
0.4921			12.500	14.00	182.00	133.00	9057460125000
0.5000	1/2		12.700	14.00	182.00	133.00	9057460127000

Alternative Drill Series:

#5512 Carbide, RT100, 7xD, 140 U pt, FIREX®

4xD



Bright finish



Coolant Through



Reinforced Straight Shank

Speeds & Feeds
information pg 494

Series 6068

RT 150 GG

Carbide, RT 150 GG straight flute high penetration, 4xD,
130° point, reinforced straight shank, RH cut

Cut Dia. = m7 tolerance range, Shank Dia. = h6

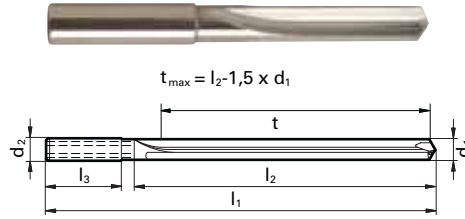

Application Materials:



Cast Iron

Twist Drills

Diameter (d1)			d2	l1	l2	EDP #	
Dec. inch	Fract. inch	Wire / letter	mm	mm	mm		
0.1181			3.000	6.000	66.00	24.00	9060680030000
0.1220			3.100	6.000	66.00	24.00	9060680031000
0.1260			3.200	6.000	66.00	24.00	9060680032000
0.1299			3.300	6.000	66.00	24.00	9060680033000
0.1339			3.400	6.000	66.00	24.00	9060680034000
0.1378			3.500	6.000	66.00	24.00	9060680035000
0.1417			3.600	6.000	66.00	24.00	9060680036000
0.1457			3.700	6.000	66.00	24.00	9060680037000
0.1496		25	3.800	6.000	74.00	30.00	9060680038000
0.1535			3.900	6.000	74.00	30.00	9060680039000
0.1575			4.000	6.000	74.00	30.00	9060680040000
0.1654			4.200	6.000	74.00	30.00	9060680042000
0.1772		16	4.500	6.000	74.00	30.00	9060680045000
0.1811			4.600	6.000	74.00	30.00	9060680046000
0.1890		12	4.800	6.000	74.00	36.00	9060680048000
0.1969			5.000	6.000	74.00	36.00	9060680050000
0.2008			5.100	6.000	74.00	36.00	9060680051000
0.2031	13/64		5.160	6.000	74.00	36.00	9060680051600
0.2047			5.200	6.000	74.00	36.00	9060680052000
0.2087			5.300	6.000	74.00	36.00	9060680053000
0.2126			5.400	6.000	74.00	36.00	9060680054000
0.2165			5.500	6.000	74.00	36.00	9060680055000
0.2189		7/32	5.560	6.000	74.00	36.00	9060680055600
0.2205			5.600	6.000	74.00	36.00	9060680056000
0.2283			5.800	6.000	74.00	36.00	9060680058000
0.2362			6.000	6.000	74.00	36.00	9060680060000
0.2402			6.100	8.000	91.00	53.00	9060680061000
0.2441			6.200	8.000	91.00	53.00	9060680062000
0.2480			6.300	8.000	91.00	53.00	9060680063000
0.2500	1/4	E	6.350	8.000	91.00	53.00	9060680063500
0.2520			6.400	8.000	91.00	53.00	9060680064000
0.2559			6.500	8.000	91.00	53.00	9060680065000
0.2598			6.600	8.000	91.00	53.00	9060680066000
0.2657	17/64	H	6.750	8.000	91.00	53.00	9060680067500
0.2677			6.800	8.000	91.00	53.00	9060680068000
0.2717		I	6.900	8.000	91.00	53.00	9060680069000
0.2756			7.000	8.000	91.00	53.00	9060680070000
0.2795			7.100	8.000	91.00	53.00	9060680071000
0.2811	9/32	K	7.140	8.000	91.00	53.00	9060680071400
0.2835			7.200	8.000	91.00	53.00	9060680072000
0.2874			7.300	8.000	91.00	53.00	9060680073000
0.2913			7.400	8.000	91.00	53.00	9060680074000
0.2953			7.500	8.000	91.00	53.00	9060680075000
0.2969	19/64		7.540	8.000	91.00	53.00	9060680075400
0.3071			7.800	8.000	91.00	53.00	9060680078000
0.3150			8.000	8.000	91.00	53.00	9060680080000
0.3189			8.100	10.000	103.00	61.00	9060680081000
0.3228		P	8.200	10.000	103.00	61.00	9060680082000
0.3268			8.300	10.000	103.00	61.00	9060680083000

Diameter (d1)			d2	l1	l2	EDP #	
Dec. inch	Fract. inch	Wire / letter	mm	mm	mm		
0.3307			8.400	10.000	103.00	61.00	9060680084000
0.3346			8.500	10.000	103.00	61.00	9060680085000
0.3386			8.600	10.000	103.00	61.00	9060680086000
0.3425			8.700	10.000	103.00	61.00	9060680087000
0.3437	11/32		8.730	10.000	103.00	61.00	9060680087300
0.3543			9.000	10.000	103.00	61.00	9060680090000
0.3594	23/64		9.130	10.000	103.00	61.00	9060680091300
0.3622			9.200	10.000	103.00	61.00	9060680092000
0.3661			9.300	10.000	103.00	61.00	9060680093000
0.3740			9.500	10.000	103.00	61.00	9060680095000
0.3748	3/8		9.520	10.000	103.00	61.00	9060680095200
0.3780			9.600	10.000	103.00	61.00	9060680096000
0.3819			9.700	10.000	103.00	61.00	9060680097000
0.3858		W	9.800	10.000	103.00	61.00	9060680098000
0.3906	25/64		9.920	10.000	103.00	61.00	9060680099200
0.3937			10.000	10.000	103.00	61.00	9060680100000
0.4016			10.200	12.000	118.00	71.00	9060680102000
0.4134			10.500	12.000	118.00	71.00	9060680105000
0.4220	27/64		10.720	12.000	118.00	71.00	9060680107200
0.4331			11.000	12.000	118.00	71.00	9060680110000
0.4374	7/16		11.110	12.000	118.00	71.00	9060680111100
0.4528			11.500	12.000	118.00	71.00	9060680115000
0.4724			12.000	12.000	118.00	71.00	9060680120000
0.4843	31/64		12.300	14.000	124.00	74.00	9060680123000
0.4921			12.500	14.000	124.00	74.00	9060680125000
0.5000	1/2		12.700	14.000	124.00	74.00	9060680127000
0.5118			13.000	14.000	124.00	74.00	9060680130000
0.5315			13.500	14.000	124.00	74.00	9060680135000
0.5512			14.000	14.000	124.00	74.00	9060680140000
0.5709			14.500	16.000	133.00	83.00	9060680145000
0.5906			15.000	16.000	133.00	83.00	9060680150000
0.6102			15.500	16.000	133.00	83.00	9060680155000
0.6299			16.000	16.000	133.00	83.00	9060680160000
0.6496			16.500	18.000	143.00	93.00	9060680165000
0.6693			17.000	18.000	143.00	93.00	9060680170000
0.6890			17.500	18.000	143.00	93.00	9060680175000
0.7087			18.000	18.000	143.00	93.00	9060680180000
0.7283			18.500	20.000	153.00	101.00	9060680185000
0.7480			19.000	20.000	153.00	101.00	9060680190000
0.7677			19.500	20.000	153.00	101.00	9060680195000
0.7874			20.000	20.000	153.00	101.00	9060680200000

Alternative Drill Series:

- #768 Carbide, RT150GG, 4xD, 120 pt, Bright
- #769 Carbide, RT150GG, 7xD, 120 pt, Bright
- #6069 K20 Carbide, RT150GG, 7xD, 130 pt, Bright

*Items listed in red are non-stocked items, and may take 2 - 6 weeks to receive

7xD



Bright finish

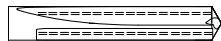

Coolant Through



Reinforced Straight Shank

Speeds & Feeds
information pg 495

Series 6069

RT 150 GG

Carbide, RT 150 GG straight flute high penetration, 7xD, 130° point, reinforced
straight shank, RH cut

Application Materials:



Cast Iron

Cut Dia. = m7 tolerance range, Shank Dia. = h6

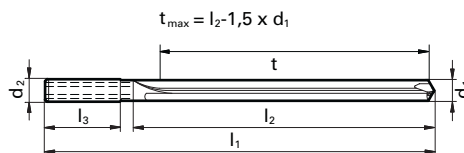

Diameter (d1)				d2 mm	l1 mm	l2 mm	EDP #
Dec. inch	Fract. inch	Wire / letter	mm				
0.1181			3.000	6.000	74.00	36.00	9060690030000
0.1220			3.100	6.000	74.00	36.00	9060690031000
0.1260			3.200	6.000	74.00	36.00	9060690032000
0.1299			3.300	6.000	74.00	36.00	9060690033000
0.1339			3.400	6.000	74.00	36.00	9060690034000
0.1378			3.500	6.000	74.00	36.00	9060690035000
0.1417			3.600	6.000	74.00	36.00	9060690036000
0.1457			3.700	6.000	74.00	36.00	9060690037000
0.1496		25	3.800	6.000	97.00	45.00	9060690038000
0.1535			3.900	6.000	97.00	45.00	9060690039000
0.1575			4.000	6.000	97.00	45.00	9060690040000
0.1614			4.100	6.000	97.00	45.00	9060690041000
0.1654			4.200	6.000	97.00	45.00	9060690042000
0.1693		18	4.300	6.000	97.00	45.00	9060690043000
0.1732			4.400	6.000	97.00	45.00	9060690044000
0.1772		16	4.500	6.000	97.00	45.00	9060690045000
0.1850		13	4.700	6.000	97.00	45.00	9060690047000
0.1890		12	4.800	6.000	97.00	57.00	9060690048000
0.1929			4.900	6.000	97.00	57.00	9060690049000
0.1969			5.000	6.000	97.00	57.00	9060690050000
0.2031		13/64	5.160	6.000	97.00	57.00	9060690051600
0.2165			5.500	6.000	97.00	57.00	9060690055000
0.2362			6.000	6.000	97.00	57.00	9060690060000
0.2500		1/4 E	6.350	8.000	116.00	76.00	9060690063500
0.2559			6.500	8.000	116.00	76.00	9060690065000
0.2677			6.800	8.000	116.00	76.00	9060690068000
0.2756			7.000	8.000	116.00	76.00	9060690070000
0.2811		9/32 K	7.140	8.000	116.00	76.00	9060690071400
0.2953			7.500	8.000	116.00	76.00	9060690075000
0.3071			7.800	8.000	116.00	76.00	9060690078000
0.3126		5/16	7.940	8.000	116.00	76.00	9060690079400
0.3150			8.000	8.000	116.00	76.00	9060690080000
0.3280		21/64	8.330	10.000	139.00	95.00	9060690083300
0.3346			8.500	10.000	139.00	95.00	9060690085000
0.3437		11/32	8.730	10.000	139.00	95.00	9060690087300
0.3543			9.000	10.000	139.00	95.00	9060690090000

Diameter (d1)				d2 mm	l1 mm	l2 mm	EDP #
Dec. inch	Fract. inch	Wire / letter	mm				
0.3594		23/64	9.130	10.000	139.00	95.00	9060690091300
0.3740			9.500	10.000	139.00	95.00	9060690095000
0.3748		3/8	9.520	10.000	139.00	95.00	9060690095200
0.3937			10.000	10.000	139.00	95.00	9060690100000
0.4016			10.200	12.000	163.00	114.00	9060690102000
0.4063		13/32	10.320	12.000	163.00	114.00	9060690103200
0.4134			10.500	12.000	163.00	114.00	9060690105000
0.4220		27/64	10.720	12.000	163.00	114.00	9060690107200
0.4331			11.000	12.000	163.00	114.00	9060690110000
0.4374		7/16	11.110	12.000	163.00	114.00	9060690111100
0.4528			11.500	12.000	163.00	114.00	9060690115000
0.4531		29/64	11.510	12.000	163.00	114.00	9060690115100
0.4724			12.000	12.000	163.00	114.00	9060690120000
0.4843		31/64	12.300	14.000	182.00	133.00	9060690123000
0.4921			12.500	14.000	182.00	133.00	9060690125000
0.5000		1/2	12.700	14.000	182.00	133.00	9060690127000
0.5118			13.000	14.000	182.00	133.00	9060690130000
0.5315			13.500	14.000	182.00	133.00	9060690135000
0.5512			14.000	14.000	182.00	133.00	9060690140000
0.5709			14.500	16.000	204.00	152.00	9060690145000
0.5906			15.000	16.000	204.00	152.00	9060690150000
0.6102			15.500	16.000	204.00	152.00	9060690155000
0.6299			16.000	16.000	204.00	152.00	9060690160000
0.6496			16.500	18.000	223.00	171.00	9060690165000
0.6693			17.000	18.000	223.00	171.00	9060690170000
0.6890			17.500	18.000	223.00	171.00	9060690175000
0.7087			18.000	18.000	223.00	171.00	9060690180000
0.7283			18.500	20.000	244.00	190.00	9060690185000
0.7480			19.000	20.000	244.00	190.00	9060690190000
0.7677			19.500	20.000	244.00	190.00	9060690195000
0.7874			20.000	20.000	244.00	190.00	9060690200000

Alternative Drill Series:

#769 Carbide, RT150GG, 7xD, 120 pt, Bright
#6070 K20 Carb, RT150GG, 10xD, 130 pt, Bright

10xD

Series 6070

Application Materials:



Bright finish



Cast Iron

RT 150 GG

Carbide, RT 150 GG straight flute high penetration, 10xD,
130° point, reinforced straight shank, RH cut

Cut Dia. = m7 tolerance range, Shank Dia. = h6

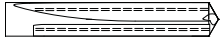

Coolant Through



Reinforced Straight Shank

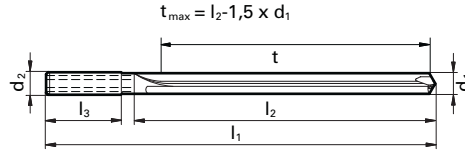

Speeds & Feeds
information pg 495

Dec. inch	Diameter (d1)		mm	d2 mm	l1 mm	l2 mm	EDP #
	Fract. inch	Wire / letter					
0.1181			3.000	6.000	91.00	42.00	9060700030000
0.1220			3.100	6.000	91.00	42.00	9060700031000
0.1260			3.200	6.000	91.00	42.00	9060700032000
0.1299			3.300	6.000	91.00	42.00	9060700033000
0.1339			3.400	6.000	91.00	48.00	9060700034000
0.1378			3.500	6.000	91.00	48.00	9060700035000
0.1417			3.600	6.000	91.00	48.00	9060700036000
0.1457			3.700	6.000	91.00	48.00	9060700037000
0.1496		25	3.800	6.000	121.00	77.00	9060700038000
0.1535			3.900	6.000	121.00	77.00	9060700039000
0.1575			4.000	6.000	121.00	77.00	9060700040000
0.1614			4.100	6.000	121.00	77.00	9060700041000
0.1654			4.200	6.000	121.00	77.00	9060700042000
0.1693		18	4.300	6.000	121.00	77.00	9060700043000
0.1732			4.400	6.000	121.00	77.00	9060700044000
0.1772		16	4.500	6.000	121.00	77.00	9060700045000
0.1850		13	4.700	6.000	121.00	77.00	9060700047000
0.1890		12	4.800	6.000	121.00	82.00	9060700048000
0.1929			4.900	6.000	121.00	82.00	9060700049000
0.1969			5.000	6.000	121.00	82.00	9060700050000
0.2031		13/64	5.160	6.000	121.00	82.00	9060700051600
0.2165			5.500	6.000	121.00	82.00	9060700055000
0.2362			6.000	6.000	121.00	82.00	9060700060000
0.2500		1/4 E	6.350	8.000	146.00	106.00	9060700063500
0.2559			6.500	8.000	146.00	106.00	9060700065000
0.2677			6.800	8.000	146.00	106.00	9060700068000
0.2756			7.000	8.000	146.00	106.00	9060700070000
0.2811		9/32 K	7.140	8.000	146.00	106.00	9060700071400
0.2953			7.500	8.000	146.00	106.00	9060700075000
0.3071			7.800	8.000	146.00	106.00	9060700078000
0.3126		5/16	7.940	8.000	146.00	106.00	9060700079400
0.3150			8.000	8.000	146.00	106.00	9060700080000
0.3280		21/64	8.330	10.000	175.00	130.00	9060700083300
0.3346			8.500	10.000	175.00	130.00	9060700085000
0.3437		11/32	8.730	10.000	175.00	130.00	9060700087300
0.3543			9.000	10.000	175.00	130.00	9060700090000

Dec. inch	Diameter (d1)		mm	d2 mm	l1 mm	l2 mm	EDP #
	Fract. inch	Wire / letter					
0.3594		23/64	9.130	10.000	175.00	130.00	9060700091300
0.3740			9.500	10.000	175.00	130.00	9060700095000
0.3748		3/8	9.520	10.000	175.00	130.00	9060700095200
0.3937			10.000	10.000	175.00	130.00	9060700100000
0.4016			10.200	12.000	209.00	159.00	9060700102000
0.4063		13/32	10.320	12.000	209.00	159.00	9060700103200
0.4134			10.500	12.000	209.00	159.00	9060700105000
0.4220		27/64	10.720	12.000	209.00	159.00	9060700107200
0.4331			11.000	12.000	209.00	159.00	9060700110000
0.4374		7/16	11.110	12.000	209.00	159.00	9060700111100
0.4528			11.500	12.000	209.00	159.00	9060700115000
0.4531		29/64	11.510	12.000	209.00	159.00	9060700115100
0.4724			12.000	12.000	209.00	159.00	9060700120000
0.4843		31/64	12.300	14.000	233.00	183.00	9060700123000
0.4921			12.500	14.000	233.00	183.00	9060700125000
0.5000		1/2	12.700	14.000	233.00	183.00	9060700127000
0.5118			13.000	14.000	233.00	183.00	9060700130000
0.5315			13.500	14.000	233.00	183.00	9060700135000
0.5512			14.000	14.000	233.00	183.00	9060700140000
0.5709			14.500	16.000	260.00	207.00	9060700145000
0.5906			15.000	16.000	260.00	207.00	9060700150000
0.6102			15.500	16.000	260.00	207.00	9060700155000
0.6299			16.000	16.000	260.00	207.00	9060700160000
0.6496			16.500	18.000	284.00	231.00	9060700165000
0.6693			17.000	18.000	284.00	231.00	9060700170000
0.6890			17.500	18.000	284.00	231.00	9060700175000
0.7087			18.000	18.000	284.00	231.00	9060700180000
0.7283			18.500	20.000	308.00	255.00	9060700185000
0.7480			19.000	20.000	308.00	255.00	9060700190000
0.7677			19.500	20.000	308.00	255.00	9060700195000
0.7874			20.000	20.000	308.00	255.00	9060700200000

Alternative Drill Series:

- #5513 Carbide, RT150GG, 10xD, 120 pt, Bright
- #770 Carbide, RT150GG, 10xD, 120 pt, Bright

*Items listed in red are non-stocked items, and may take 2 - 6 weeks to receive

Micro drill

A

TiAlN™ coated



Coolant Through



Reinforced Straight Shank

Speeds & Feeds
information pg 497

Exclusive Line®

Coolant-fed

Carbide, Exclusive Line Micro Drills, 140° 4-facet ground hone point, reinforced straight shank, RH helix

Cut Dia. = m7 tolerance range, Shank Dia. = h6

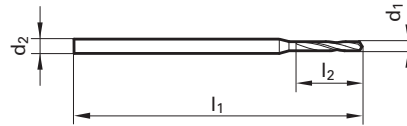

Application Materials:

- General Steels/Brass
- Universal Steels
- Stainless Steels
- Cast Iron
- Ti & Ni Alloys
- Aluminum & Alloys

Twist Drills

Series 6405 (5xD)

Diameter (d1)		Wire / letter	mm	d2 mm	l1 mm	l2 mm	EDP #
Dec. inch	Fract. inch						
0.0551			1.40	4.00	52.00	11.00	9064050014000
0.0571			1.45	4.00	52.00	12.00	9064050014500
0.0591			1.50	4.00	52.00	12.00	9064050015000
0.0610		#54	1.55	4.00	52.00	12.00	9064050015500
0.0626	1/16		1.59	4.00	52.00	13.00	9064050015900
0.0630			1.60	4.00	52.00	13.00	9064050016000
0.0650			1.65	4.00	52.00	13.00	9064050016500
0.0669		#51	1.70	4.00	56.00	14.00	9064050017000
0.0689			1.75	4.00	56.00	14.00	9064050017500
0.0709			1.80	4.00	56.00	14.00	9064050018000
0.0728		#49	1.85	4.00	56.00	15.00	9064050018500
0.0748			1.90	4.00	56.00	15.00	9064050019000
0.0768			1.95	4.00	56.00	16.00	9064050019500
0.0780	5/64		1.98	4.00	56.00	16.00	9064050019800
0.0787			2.00	4.00	56.00	16.00	9064050020000
0.0807			2.05	4.00	56.00	16.00	9064050020500
0.0827			2.10	4.00	62.00	17.00	9064050021000
0.0846			2.15	4.00	62.00	17.00	9064050021500
0.0866			2.20	4.00	62.00	18.00	9064050022000
0.0886			2.25	4.00	62.00	18.00	9064050022500
0.0906			2.30	4.00	62.00	18.00	9064050023000
0.0925			2.35	4.00	62.00	19.00	9064050023500

Diameter (d1)		Wire / letter	mm	d2 mm	l1 mm	l2 mm	EDP #
Dec. inch	Fract. inch						
0.0937	3/32		2.38	4.00	62.00	19.00	9064050023800
0.0945			2.40	4.00	62.00	19.00	9064050024000
0.0965			2.45	4.00	62.00	20.00	9064050024500
0.0984			2.50	4.00	62.00	20.00	9064050025000
0.1004			2.55	4.00	62.00	20.00	9064050025500
0.1024			2.60	4.00	66.00	21.00	9064050026000
0.1043			2.65	4.00	66.00	21.00	9064050026500
0.1063			2.70	4.00	66.00	22.00	9064050027000
0.1083			2.75	4.00	66.00	22.00	9064050027500
0.1094	7/64		2.78	4.00	66.00	22.00	9064050027800
0.1102			2.80	4.00	66.00	22.00	9064050028000
0.1122			2.85	4.00	66.00	23.00	9064050028500
0.1142			2.90	4.00	66.00	23.00	9064050029000
0.1161		#32	2.95	4.00	66.00	24.00	9064050029500
0.1181			3.00	4.00	66.00	24.00	9064050030000

Alternative Drill Series:
#6408 Carbide, Exclusive Line, 8xD, 135 4-facet pt., TiAlN

*Items listed in red are non-stocked items, and may take 2 - 6 weeks to receive

Micro drill

A

TiAlN coated



Coolant Through



Reinforced Straight Shank

Speeds & Feeds
information pg 497

Exclusive Line®

Coolant-fed

Carbide, Exclusive Line Micro Drills, 135° 4-facet
ground hone point, reinforced straight shank, RH helix

Cut Dia. = h7 tolerance range, Shank Dia. = h6



Application Materials:

- General Steels/Brass
- Universal Steels
- Stainless Steels
- Cast Iron
- Ti & Ni Alloys
- Aluminum & Alloys

Series 6408 (8xD)

Series 6412 (15xD)

Diameter (d1)		Wire / letter	mm	d2 mm	l1 mm	l2 mm	EDP #
Dec. inch	Fract. inch						
0.0551		54	1.400	4.000	52.00	15.00	9064080014000
0.0571			1.450	4.000	52.00	16.00	9064080014500
0.0591			1.500	4.000	52.00	17.00	9064080015000
0.0610			1.550	4.000	52.00	17.00	9064080015500
0.0626	1/16		1.590	4.000	52.00	18.00	9064080015900
0.0630			1.600	4.000	52.00	18.00	9064080016000
0.0650			1.650	4.000	52.00	18.00	9064080016500
0.0669		51	1.700	4.000	56.00	19.00	9064080017000
0.0689			1.750	4.000	56.00	19.00	9064080017500
0.0709			1.800	4.000	56.00	20.00	9064080018000
0.0728		49	1.850	4.000	56.00	20.00	9064080018500
0.0748			1.900	4.000	56.00	21.00	9064080019000
0.0768			1.950	4.000	56.00	21.00	9064080019500
0.0780	5/64		1.980	4.000	56.00	22.00	9064080019800
0.0787			2.000	4.000	56.00	22.00	9064080020000
0.0807			2.050	4.000	56.00	23.00	9064080020500
0.0827			2.100	4.000	62.00	23.00	9064080021000
0.0846			2.150	4.000	62.00	24.00	9064080021500
0.0866			2.200	4.000	62.00	24.00	9064080022000
0.0886			2.250	4.000	62.00	25.00	9064080022500
0.0906			2.300	4.000	62.00	25.00	9064080023000
0.0913			2.320	4.000	62.00	25.00	9064080023200
0.0925			2.350	4.000	62.00	26.00	9064080023500
0.0937	3/32		2.380	4.000	62.00	26.00	9064080023800
0.0945			2.400	4.000	62.00	26.00	9064080024000
0.0965			2.450	4.000	62.00	27.00	9064080024500
0.0984			2.500	4.000	62.00	28.00	9064080025000
0.1004			2.550	4.000	62.00	28.00	9064080025500
0.1024			2.600	4.000	66.00	29.00	9064080026000
0.1043			2.650	4.000	66.00	29.00	9064080026500
0.1063			2.700	4.000	66.00	30.00	9064080027000
0.1083			2.750	4.000	66.00	30.00	9064080027500
0.1094	7/64		2.780	4.000	66.00	31.00	9064080027800
0.1102			2.800	4.000	66.00	31.00	9064080028000
0.1122			2.850	4.000	66.00	31.00	9064080028500
0.1142			2.900	4.000	66.00	32.00	9064080029000
0.1161		32	2.950	4.000	66.00	32.00	9064080029500
0.1181			3.000	4.000	66.00	33.00	9064080030000

Alternative Drill Series:

#6412 Carbide, Micro, 15xD, 135 pt, TiAlN Tipped

Diameter (d1)		Wire / letter	mm	d2 mm	l1 mm	l2 mm	EDP #
Dec. inch	Fract. inch						
0.0551			1.400	4.000	62.00	25.00	9064120014000
0.0591			1.500	4.000	62.00	27.00	9064120015000
0.0626	1/16		1.590	4.000	62.00	29.00	9064120015900
0.0630			1.600	4.000	62.00	29.00	9064120016000
0.0669			1.700	4.000	70.00	31.00	9064120017000
0.0709			1.800	4.000	70.00	32.00	9064120018000
0.0748			1.900	4.000	70.00	34.00	9064120019000
0.0780	5/64		1.980	4.000	70.00	36.00	9064120019800
0.0787			2.000	4.000	70.00	36.00	9064120020000
0.0827			2.100	4.000	78.00	38.00	9064120021000
0.0866			2.200	4.000	78.00	40.00	9064120022000
0.0906			2.300	4.000	78.00	42.00	9064120023000
0.0937	3/32		2.380	4.000	78.00	44.00	9064120023800
0.0945			2.400	4.000	78.00	44.00	9064120024000
0.0984			2.500	4.000	78.00	45.00	9064120025000
0.1024			2.600	4.000	87.00	47.00	9064120026000
0.1063			2.700	4.000	87.00	48.00	9064120027000
0.1094	7/64		2.780	4.000	87.00	50.00	9064120027800
0.1102			2.800	4.000	87.00	50.00	9064120028000
0.1142			2.900	4.000	87.00	52.00	9064120029000
0.1181			3.000	4.000	87.00	54.00	9064120030000

Alternative Drill Series:

#6408 Carbide, Micro, 8xD, 135 pt, TiAlN Tipped

Pilot drilling

For applications using Series 6412 carbide micro-precision drills to drilling depths of 15xD we recommend a pilot hole 1xD up to 2xD depth.

For this pilot hole, the Series 6400 solid carbide micro-precision drill (4xD) is optimally suited. Its 140° point angle and its m7 diameter tolerance are perfectly adapted.

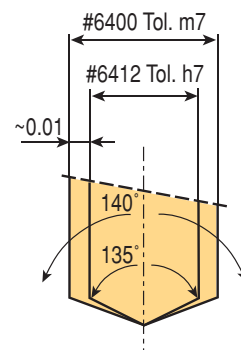

Spot Drilling

In order to achieve full performance with Series 6408 carbide micro-precision drills at 8xD drilling depth, we recommend spot drilling.

The ExclusiveLine Series 6400 solid carbide micro-precision drill (up to 4xD) can be applied for this purpose. The spot drill diameter should be approximately $\frac{2}{3} \times d_1$.

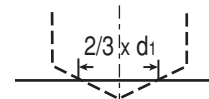

Series 6501

Speeds & Feeds information pg 498

Diameter (d1)			d2 mm	l1 mm	l2 mm	EDP #	
Dec. inch	Fract. inch	Wire / letter					mm
0.4409			11.200	12.000	118.00	71.00	9065010112000
0.4449			11.300	12.000	118.00	71.00	9065010113000
0.4488			11.400	12.000	118.00	71.00	9065010114000
0.4528			11.500	12.000	118.00	71.00	9065010115000
0.4567			11.600	12.000	118.00	71.00	9065010116000
0.4606			11.700	12.000	118.00	71.00	9065010117000
0.4646			11.800	12.000	118.00	71.00	9065010118000
0.4685			11.900	12.000	118.00	71.00	9065010119000
0.4689	15/32		11.910	12.000	118.00	71.00	9065010119100
0.4724			12.000	12.000	118.00	71.00	9065010120000
0.4764			12.100	14.000	124.00	77.00	9065010121000
0.4803			12.200	14.000	124.00	77.00	9065010122000
0.4843	31/64		12.300	14.000	124.00	77.00	9065010123000
0.4882			12.400	14.000	124.00	77.00	9065010124000
0.4921			12.500	14.000	124.00	77.00	9065010125000
0.4961			12.600	14.000	124.00	77.00	9065010126000
0.5000	1/2		12.700	14.000	124.00	77.00	9065010127000
0.5039			12.800	14.000	124.00	77.00	9065010128000
0.5079			12.900	14.000	124.00	77.00	9065010129000
0.5118			13.000	14.000	124.00	77.00	9065010130000
0.5157	33/64		13.100	14.000	124.00	77.00	9065010131000
0.5236			13.300	14.000	124.00	77.00	9065010133000
0.5276			13.400	14.000	124.00	77.00	9065010134000
0.5315			13.500	14.000	124.00	77.00	9065010135000
0.5394			13.700	14.000	124.00	77.00	9065010137000
0.5433			13.800	14.000	124.00	77.00	9065010138000
0.5472			13.900	14.000	124.00	77.00	9065010139000
0.5512			14.000	14.000	124.00	77.00	9065010140000
0.5551			14.100	16.000	133.00	83.00	9065010141000
0.5591			14.200	16.000	133.00	83.00	9065010142000
0.5626	9/16		14.290	16.000	133.00	83.00	9065010142900
0.5630			14.300	16.000	133.00	83.00	9065010143000

Diameter (d1)			d2 mm	l1 mm	l2 mm	EDP #	
Dec. inch	Fract. inch	Wire / letter					mm
0.5669			14.400	16.000	133.00	83.00	9065010144000
0.5709			14.500	16.000	133.00	83.00	9065010145000
0.5748			14.600	16.000	133.00	83.00	9065010146000
0.5787			14.700	16.000	133.00	83.00	9065010147000
0.5866			14.900	16.000	133.00	83.00	9065010149000
0.5906			15.000	16.000	133.00	83.00	9065010150000
0.5945			15.100	16.000	133.00	83.00	9065010151000
0.5984			15.200	16.000	133.00	83.00	9065010152000
0.6024			15.300	16.000	133.00	83.00	9065010153000
0.6063			15.400	16.000	133.00	83.00	9065010154000
0.6102			15.500	16.000	133.00	83.00	9065010155000
0.6142			15.600	16.000	133.00	83.00	9065010156000
0.6181			15.700	16.000	133.00	83.00	9065010157000
0.6220			15.800	16.000	133.00	83.00	9065010158000
0.6248	5/8		15.870	16.000	133.00	83.00	9065010158700
0.6260			15.900	16.000	133.00	83.00	9065010159000
0.6299			16.000	16.000	133.00	83.00	9065010160000
0.6496			16.500	18.000	143.00	93.00	9065010165000
0.6563	21/32		16.670	18.000	143.00	93.00	9065010166700
0.6693			17.000	18.000	143.00	93.00	9065010170000
0.6890			17.500	18.000	143.00	93.00	9065010175000
0.7087			18.000	18.000	143.00	93.00	9065010180000
0.7283			18.500	20.000	153.00	101.00	9065010185000
0.7480			19.000	20.000	153.00	101.00	9065010190000
0.7677			19.500	20.000	153.00	101.00	9065010195000
0.7874			20.000	20.000	153.00	101.00	9065010200000

Alternative Drill Series:

#5511 Carbide, RT100, 5xD, 140 U pt, FIREX®

Series 6502

Speeds & Feeds information pg 498

Diameter (d1)							EDP #
Dec. inch	Fract. inch	Wire / letter	mm	d2 mm	l1 mm	l2 mm	
0.4961			12.600	14.000	182.00	133.00	9065020126000
0.5000	1/2		12.700	14.000	182.00	133.00	9065020127000
0.5039			12.800	14.000	182.00	133.00	9065020128000
0.5079			12.900	14.000	182.00	133.00	9065020129000
0.5118			13.000	14.000	182.00	133.00	9065020130000
0.5157	33/64		13.100	14.000	182.00	133.00	9065020131000
0.5236			13.300	14.000	182.00	133.00	9065020133000
0.5276			13.400	14.000	182.00	133.00	9065020134000
0.5315			13.500	14.000	182.00	133.00	9065020135000
0.5394			13.700	14.000	182.00	133.00	9065020137000
0.5433			13.800	14.000	182.00	133.00	9065020138000
0.5472			13.900	14.000	182.00	133.00	9065020139000
0.5512			14.000	14.000	182.00	133.00	9065020140000
0.5551			14.100	16.000	204.00	152.00	9065020141000
0.5591			14.200	16.000	204.00	152.00	9065020142000
0.5626	9/16		14.290	16.000	204.00	152.00	9065020142900
0.5630			14.300	16.000	204.00	152.00	9065020143000
0.5669			14.400	16.000	204.00	152.00	9065020144000
0.5709			14.500	16.000	204.00	152.00	9065020145000
0.5748			14.600	16.000	204.00	152.00	9065020146000
0.5787			14.700	16.000	204.00	152.00	9065020147000
0.5866			14.900	16.000	204.00	152.00	9065020149000
0.5906			15.000	16.000	204.00	152.00	9065020150000
0.5945			15.100	16.000	204.00	152.00	9065020151000

Diameter (d1)							EDP #
Dec. inch	Fract. inch	Wire / letter	mm	d2 mm	l1 mm	l2 mm	
0.5984			15.200	16.000	204.00	152.00	9065020152000
0.6024			15.300	16.000	204.00	152.00	9065020153000
0.6063			15.400	16.000	204.00	152.00	9065020154000
0.6102			15.500	16.000	204.00	152.00	9065020155000
0.6142			15.600	16.000	204.00	152.00	9065020156000
0.6181			15.700	16.000	204.00	152.00	9065020157000
0.6220			15.800	16.000	204.00	152.00	9065020158000
0.6248	5/8		15.870	16.000	204.00	152.00	9065020158700
0.6260			15.900	16.000	204.00	152.00	9065020159000
0.6299			16.000	16.000	204.00	152.00	9065020160000
0.6496			16.500	18.000	223.00	171.00	9065020165000
0.6563	21/32		16.670	18.000	223.00	171.00	9065020166700
0.6693			17.000	18.000	223.00	171.00	9065020170000
0.6890			17.500	18.000	223.00	171.00	9065020175000
0.7087			18.000	18.000	223.00	171.00	9065020180000
0.7283			18.500	20.000	244.00	190.00	9065020185000
0.7480			19.000	20.000	244.00	190.00	9065020190000
0.7677			19.500	20.000	244.00	190.00	9065020195000
0.7874			20.000	20.000	244.00	190.00	9065020200000

Alternative Drill Series:

#5512 Carbide, RT100, 7xD, 140 U pt, FIREX®

Extra Length

A

TiAlN tipped



Coolant Through



Reinforced Straight Shank

Speeds & Feeds information pg 499

RT 100 T Deep Hole Drill

Carbide, RT 100 T high penetration,
135° point, standard straight shank, RH helix

Cut Dia. = h7 tolerance range, Shank Dia. = h6

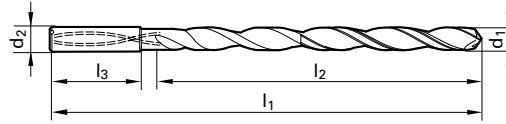

Application Materials:

- General Steels/Brass
- Universal Steels
- Stainless Steels
- Cast Iron

Twist Drills

Series 6509 (15xD)

Diameter (d1)				d2 mm	l1 mm	l2 mm	EDP #
Dec. inch	Fract. inch	Wire / letter	mm				
0.1181			3.000	6.000	95.00	55.00	9065090030000
0.1250	1/8		3.170	6.00	106.00	67.00	9065090031700
0.1378			3.500	6.00	116.00	76.00	9065090035000
0.1406	9/64		3.570	6.00	116.00	76.00	9065090035700
0.1563	5/32		3.970	6.00	116.00	76.00	9065090039700
0.1575			4.000	6.00	116.00	76.00	9065090040000
0.1719	11/64		4.370	6.00	133.00	93.00	9065090043700
0.1772			4.500	6.00	133.00	93.00	9065090045000
0.1874	3/16		4.760	6.00	133.00	93.00	9065090047600
0.1969			5.000	6.00	133.00	93.00	9065090050000
0.2008			5.100	6.00	150.00	110.00	9065090051000
0.2030	13/64		5.160	6.00	150.00	110.00	9065090051600
0.2130			5.410	6.00	150.00	110.00	9065090054100
0.2165			5.500	6.00	150.00	110.00	9065090055000
0.2189	7/32		5.560	6.00	150.00	110.00	9065090055600
0.2344	15/64		5.950	6.00	150.00	110.00	9065090059500
0.2362			6.000	6.00	150.00	110.00	9065090060000
0.2500	1/4		6.350	8.00	167.00	127.00	9065090063500
0.2559			6.500	8.00	167.00	127.00	9065090065000
0.2656	17/64		6.750	8.00	167.00	127.00	9065090067500
0.2756			7.000	8.00	167.00	127.00	9065090070000
0.2811	9/32	K	7.140	8.00	183.00	143.00	9065090071400
0.2953			7.500	8.00	183.00	143.00	9065090075000
0.2969			7.540	8.00	183.00	143.00	9065090075400
0.3120	19/64		7.940	8.00	183.00	143.00	9065090079400
0.3150			8.000	8.00	183.00	143.00	9065090080000
0.3281	21/64		8.330	10.00	204.00	160.00	9065090083300
0.3346			8.500	10.00	204.00	160.00	9065090085000
0.3438	11/32		8.730	10.00	204.00	160.00	9065090087300
0.3543			9.000	10.00	204.00	160.00	9065090090000
0.3594	23/64		9.130	10.00	221.00	177.00	9065090091300
0.3750	3/8		9.520	10.00	221.00	177.00	9065090095200
0.3906	25/64		9.920	10.00	221.00	177.00	9065090099200
0.3937			10.000	10.00	221.00	177.00	9065090100000
0.4063	13/32		10.320	12.00	247.00	198.00	9065090103200
0.4219	27/64		10.720	12.00	247.00	198.00	9065090107200
0.4330			11.000	12.00	247.00	198.00	9065090110000
0.4370	7/16		11.110	12.00	263.00	214.00	9065090111100
0.4531	29/64		11.510	12.00	263.00	214.00	9065090115100
0.4688	15/32		11.910	12.00	263.00	214.00	9065090119100
0.4724			12.000	12.00	263.00	214.00	9065090120000
0.4843	31/64		12.300	14.00	297.00	248.00	9065090123000
0.5000	1/2		12.700	14.00	297.00	248.00	9065090127000
0.5157	33/64		13.100	14.00	297.00	248.00	9065090131000
0.5311	17/32		13.490	14.00	297.00	248.00	9065090134900
0.5469	35/64		13.890	14.00	297.00	248.00	9065090138900
0.5512			14.000	14.00	297.00	248.00	9065090140000

Series 6511 (20xD)

Diameter (d1)				d2 mm	l1 mm	l2 mm	EDP #
Dec. inch	Fract. inch	Wire / letter	mm				
0.1181			3.000	6.000	110.00	70.00	9065110030000
0.1220			3.100	6.000	123.00	83.00	9065110031000
0.1250	1/8		3.170	6.000	123.00	83.00	9065110031700
0.1378			3.500	6.000	136.00	96.00	9065110035000
0.1406	9/64		3.570	6.000	136.00	96.00	9065110035700
0.1563	5/32		3.970	6.000	136.00	96.00	9065110039700
0.1575			4.000	6.000	136.00	96.00	9065110040000
0.1654			4.200	6.000	158.00	118.00	9065110042000
0.1719	11/64		4.370	6.000	158.00	118.00	9065110043700
0.1772			4.500	6.000	158.00	118.00	9065110045000
0.1874	3/16		4.760	6.000	158.00	118.00	9065110047600
0.1969			5.000	6.000	158.00	118.00	9065110050000
0.2008			5.100	6.000	180.00	140.00	9065110051000
0.2030	13/64		5.160	6.000	180.00	140.00	9065110051600
0.2130		3	5.410	6.000	180.00	140.00	9065110054100
0.2165			5.500	6.000	180.00	140.00	9065110055000
0.2189	7/32		5.560	6.000	180.00	140.00	9065110055600
0.2344	15/64		5.950	6.000	180.00	140.00	9065110059500
0.2362			6.000	6.000	180.00	140.00	9065110060000
0.2500	1/4		6.350	8.000	202.00	162.00	9065110063500
0.2559			6.500	8.000	202.00	162.00	9065110065000
0.2656	17/64		6.750	8.000	202.00	162.00	9065110067500
0.2756			7.000	8.000	202.00	162.00	9065110070000
0.2811	9/32	K	7.140	8.000	223.00	183.00	9065110071400
0.2953			7.500	8.000	223.00	183.00	9065110075000
0.2969			7.540	8.000	223.00	183.00	9065110075400
0.3120	19/64		7.940	8.000	223.00	183.00	9065110079400
0.3150			8.000	8.000	223.00	183.00	9065110080000
0.3281	21/64		8.330	10.000	249.00	205.00	9065110083300
0.3346			8.500	10.000	249.00	205.00	9065110085000
0.3438	11/32		8.731	10.000	249.00	205.00	9065110087300
0.3543			9.000	10.000	249.00	205.00	9065110090000
0.3594	23/64		9.130	10.000	271.00	227.00	9065110091300
0.3750	3/8		9.520	10.000	271.00	227.00	9065110095200
0.3906	25/64		9.920	10.000	271.00	227.00	9065110099200
0.3937			10.000	10.000	271.00	227.00	9065110100000
0.4063	13/32		10.320	12.000	302.00	242.00	9065110103200
0.4219	27/64		10.720	12.000	302.00	242.00	9065110107200
0.4330			11.000	12.000	302.00	253.00	9065110110000
0.4370	7/16		11.110	12.000	323.00	274.00	9065110111100
0.4531	29/64		11.510	12.000	323.00	274.00	9065110115100
0.4688	15/32		11.910	12.000	323.00	274.00	9065110119100
0.4724			12.000	12.000	323.00	274.00	9065110120000
0.4843	31/64		12.300	14.000	367.00	318.00	9065110123000
0.5000	1/2		12.700	14.000	367.00	318.00	9065110127000
0.5157	33/64		13.100	14.000	367.00	318.00	9065110131000
0.5311	17/32		13.490	14.000	367.00	318.00	9065110134900
0.5469	35/64		13.890	14.000	367.00	318.00	9065110138900
0.5512			14.000	14.000	367.00	318.00	9065110140000

*Items listed in red are non-stocked items, and may take 2 - 6 weeks to receive

RT 100T Deep Hole Drill

Speeds & Feeds information pg 499-500

Twist Drills

Series 6512 (25xD)

Diameter (d1)			d2 mm	l1 mm	l2 mm	EDP #
Dec. inch	Fract. inch	Wire / letter				
0.1181			3.000	125.00	85.00	9065120030000
0.1220			3.100	141.00	101.00	9065120031000
0.1250	1/8		3.170	141.00	101.00	9065120031700
0.1378			3.500	156.00	116.00	9065120035000
0.1406	9/64		3.570	156.00	116.00	9065120035700
0.1496			3.800	156.00	116.00	9065120038000
0.1563	5/32		3.970	156.00	116.00	9065120039700
0.1575			4.000	156.00	116.00	9065120040000
0.1654			4.200	183.00	143.00	9065120042000
0.1719	11/64		4.370	183.00	143.00	9065120043700
0.1772			4.500	183.00	143.00	9065120045000
0.1874	3/16		4.760	183.00	143.00	9065120047600
0.1969			5.000	183.00	143.00	9065120050000
0.2008			5.100	210.00	170.00	9065120051000
0.2030	13/64		5.160	210.00	170.00	9065120051600
0.2130		3	5.410	210.00	170.00	9065120054100
0.2165			5.500	210.00	170.00	9065120055000
0.2189	7/32		5.560	210.00	170.00	9065120055600
0.2344	15/64		5.950	210.00	170.00	9065120059500
0.2362			6.000	210.00	170.00	9065120060000
0.2480			6.300	237.00	197.00	9065120063000
0.2500	1/4		6.350	237.00	197.00	9065120063500
0.2559			6.500	237.00	197.00	9065120065000
0.2656	17/64		6.750	237.00	197.00	9065120067500
0.2756			7.000	237.00	197.00	9065120070000
0.2811	9/32	K	7.140	263.00	223.00	9065120071400
0.2953			7.500	263.00	223.00	9065120075000
0.2969	19/64		7.540	263.00	223.00	9065120075400
0.3120	5/16		7.940	263.00	223.00	9065120079400
0.3150			8.000	263.00	223.00	9065120080000
0.3281	21/64		8.330	294.00	250.00	9065120083300
0.3346			8.500	294.00	250.00	9065120085000
0.3438	11/32		8.731	294.00	250.00	9065120087300
0.3465			8.800	294.00	250.00	9065120088000
0.3543			9.000	294.00	250.00	9065120090000
0.3594	23/64		9.130	321.00	250.00	9065120091300
0.3750	3/8		9.520	321.00	277.00	9065120095200
0.3906	25/64		9.920	321.00	277.00	9065120099200
0.3937			10.000	321.00	277.00	9065120100000
0.4063	13/32		10.320	359.00	310.00	9065120103200
0.4219	27/64		10.720	359.00	310.00	9065120107200
0.4330			11.000	359.00	310.00	9065120110000
0.4370	7/16		11.110	386.00	337.00	9065120111100
0.4531	29/64		11.510	386.00	337.00	9065120115100
0.4689	15/32		11.910	386.00	337.00	9065120119100
0.4724			12.000	386.00	337.00	9065120120000

Series 6513 (30xD)

Diameter (d1)			d2 mm	l1 mm	l2 mm	EDP #
Dec. inch	Fract. inch	Wire / letter				
0.1181			3.000	140.00	100.00	9065130030000
0.1220			3.100	158.00	118.00	9065130031000
0.1250	1/8		3.170	158.00	118.00	9065130031700
0.1378			3.500	176.00	136.00	9065130035000
0.1406	9/64		3.570	176.00	136.00	9065130035700
0.1496			3.800	176.00	136.00	9065130038000
0.1563	5/32		3.970	176.00	136.00	9065130039700
0.1575			4.000	176.00	136.00	9065130040000
0.1654			4.200	208.00	168.00	9065130042000
0.1719	11/64		4.370	208.00	168.00	9065130043700
0.1772			4.500	208.00	168.00	9065130045000
0.1874	3/16		4.760	208.00	168.00	9065130047600
0.1969			5.000	208.00	168.00	9065130050000
0.2008			5.100	240.00	200.00	9065130051000
0.2030	13/64		5.160	240.00	200.00	9065130051600
0.2130		3	5.410	240.00	200.00	9065130054100
0.2165			5.500	240.00	200.00	9065130055000

Series 6513 (30xD)

Diameter (d1)			d2 mm	l1 mm	l2 mm	EDP #
Dec. inch	Fract. inch	Wire / letter				
0.2189	7/32		5.560	240.00	200.00	9065130055600
0.2344	15/64		5.950	240.00	200.00	9065130059500
0.2362			6.000	240.00	200.00	9065130060000
0.2480			6.300	272.00	232.00	9065130063000
0.2500	1/4		6.350	272.00	232.00	9065130063500
0.2559			6.500	272.00	232.00	9065130065000
0.2656	17/64		6.750	272.00	232.00	9065130067500
0.2756			7.000	272.00	232.00	9065130070000
0.2811	9/32	K	7.140	303.00	263.00	9065130071400
0.2953			7.500	303.00	263.00	9065130075000
0.2969	19/64		7.540	303.00	263.00	9065130075400
0.3120	5/16		7.940	303.00	263.00	9065130079400
0.3150			8.000	303.00	263.00	9065130080000
0.3281	21/64		8.330	339.00	295.00	9065130083300
0.3346			8.500	339.00	295.00	9065130085000
0.3438	11/32		8.731	339.00	295.00	9065130087300
0.3465			8.800	339.00	295.00	9065130088000
0.3543			9.000	339.00	295.00	9065130090000
0.3594	23/64		9.130	371.00	295.00	9065130091300
0.3750	3/8		9.520	371.00	327.00	9065130095200
0.3906	25/64		9.920	371.00	327.00	9065130099200
0.3937			10.000	371.00	327.00	9065130100000

Series 6514 (40xD)

Diameter (d1)			d2 mm	l1 mm	l2 mm	EDP #
Dec. inch	Fract. inch	Wire / letter				
0.1181			3.000	170.00	130.00	9065140030000
0.1220			3.100	193.00	153.00	9065140031000
0.1248	1/8		3.170	193.00	153.00	9065140031700
0.1378			3.500	193.00	153.00	9065140035000
0.1406	9/64		3.570	216.00	176.00	9065140035700
0.1496			3.800	216.00	176.00	9065140038000
0.1563	5/32		3.970	216.00	176.00	9065140039700
0.1575			4.000	216.00	176.00	9065140040000
0.1654			4.200	238.00	198.00	9065140042000
0.1720	11/64		4.370	238.00	198.00	9065140043700
0.1772			4.500	238.00	198.00	9065140045000
0.1874	3/16		4.760	258.00	218.00	9065140047600
0.1969			5.000	258.00	218.00	9065140050000
0.2008			5.100	280.00	240.00	9065140051000
0.2031	13/64		5.160	280.00	240.00	9065140051600
0.2129		3	5.410	280.00	240.00	9065140054100
0.2165			5.500	280.00	240.00	9065140055000
0.2189	7/32		5.560	300.00	260.00	9065140055600
0.2343	15/64		5.950	300.00	260.00	9065140059500
0.2362			6.000	300.00	260.00	9065140060000
0.2480			6.300	322.00	282.00	9065140063000
0.2500	1/4		6.350	322.00	282.00	9065140063500
0.2559			6.500	322.00	282.00	9065140065000
0.2657	17/64		6.750	342.00	302.00	9065140067500
0.2756			7.000	342.00	302.00	9065140070000
0.2811	9/32	K	7.140	363.00	323.00	9065140071400
0.2953			7.500	363.00	323.00	9065140075000
0.2969	19/64		7.540	383.00	343.00	9065140075400
0.3120	5/16		7.940	383.00	343.00	9065140079400
0.3150			8.000	383.00	343.00	9065140080000



All deep hole drills must utilize a pilot hole.

Deep hole drills must never operate at full speed without support in the pilot hole.

3xD

Series 8510

RT 100 VA High Penetration

Carbide, RT 100 VA, 3xD, self-centering
140° VA point, reinforced straight shank, RH helix

Cut Dia. = m7 tolerance range, Shank Dia. = h6

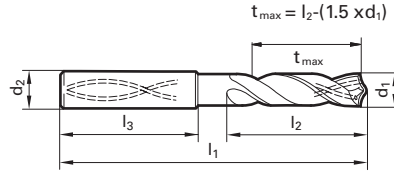

a

nano-A™ coated



Coolant Through



Reinforced Straight Shank

Speeds & Feeds
information pg 501

Application Materials:

- Universal Steels
- Stainless Steels
- Hardened Materials
- Ti & Ni Alloys

Twist Drills

Diameter (d1)			d2	l1	l2	EDP #
Dec. Inch	Fract. Inch	Wire / letter	mm	mm	mm	
0.1181			3.000	6.000	62.00	9085100030000
0.1220			3.100	6.000	62.00	9085100031000
0.1248	1/8		3.170	6.000	62.00	9085100031700
0.1260			3.200	6.000	62.00	9085100032000
0.1280			3.250	6.000	62.00	9085100032500
0.1299			3.300	6.000	62.00	9085100033000
0.1339			3.400	6.000	62.00	9085100034000
0.1378			3.500	6.000	62.00	9085100035000
0.1406	9/64	28	3.570	6.000	62.00	9085100035700
0.1417			3.600	6.000	62.00	9085100036000
0.1457			3.700	6.000	62.00	9085100037000
0.1496		25	3.800	6.000	66.00	9085100038000
0.1535			3.900	6.000	66.00	9085100039000
0.1563	5/32		3.970	6.000	66.00	9085100039700
0.1575			4.000	6.000	66.00	9085100040000
0.1614			4.100	6.000	66.00	9085100041000
0.1654			4.200	6.000	66.00	9085100042000
0.1693			4.300	6.000	66.00	9085100043000
0.1720	11/64		4.370	6.000	66.00	9085100043700
0.1732			4.400	6.000	66.00	9085100044000
0.1772		16	4.500	6.000	66.00	9085100045000
0.1811			4.600	6.000	66.00	9085100046000
0.1831			4.650	6.000	66.00	9085100046500
0.1850			4.700	6.000	66.00	9085100047000
0.1874	3/16		4.760	6.000	66.00	9085100047600
0.1890		12	4.800	6.000	66.00	9085100048000
0.1929			4.900	6.000	66.00	9085100049000
0.1969			5.000	6.000	66.00	9085100050000
0.2008			5.100	6.000	66.00	9085100051000
0.2031	13/64		5.160	6.000	66.00	9085100051600
0.2047			5.200	6.000	66.00	9085100052000
0.2087			5.300	6.000	66.00	9085100053000
0.2126			5.400	6.000	66.00	9085100054000
0.2165			5.500	6.000	66.00	9085100055000
0.2185			5.550	6.000	66.00	9085100055500
0.2189	7/32		5.560	6.000	66.00	9085100055600
0.2205			5.600	6.000	66.00	9085100056000
0.2244			5.700	6.000	66.00	9085100057000
0.2283			5.800	6.000	66.00	9085100058000
0.2323			5.900	6.000	66.00	9085100059000
0.2343	15/64		5.950	6.000	66.00	9085100059500
0.2362			6.000	6.000	66.00	9085100060000
0.2402			6.100	8.000	79.00	9085100061000
0.2441			6.200	8.000	79.00	9085100062000
0.2480			6.300	8.000	79.00	9085100063000
0.2500	1/4	E	6.350	8.000	79.00	9085100063500
0.2520			6.400	8.000	79.00	9085100064000
0.2559			6.500	8.000	79.00	9085100065000
0.2598			6.600	8.000	79.00	9085100066000
0.2638			6.700	8.000	79.00	9085100067000
0.2657	17/64	H	6.750	8.000	79.00	9085100067500
0.2677			6.800	8.000	79.00	9085100068000
0.2717		I	6.900	8.000	79.00	9085100069000
0.2756			7.000	8.000	79.00	9085100070000

Diameter (d1)			d2	l1	l2	EDP #
Dec. Inch	Fract. Inch	Wire / letter	mm	mm	mm	
0.2795			7.100	8.000	79.00	9085100071000
0.2811	9/32	K	7.140	8.000	79.00	9085100071400
0.2835			7.200	8.000	79.00	9085100072000
0.2874			7.300	8.000	79.00	9085100073000
0.2913			7.400	8.000	79.00	9085100074000
0.2953			7.500	8.000	79.00	9085100075000
0.2969	19/64		7.540	8.000	79.00	9085100075400
0.2992			7.600	8.000	79.00	9085100076000
0.3031			7.700	8.000	79.00	9085100077000
0.3071			7.800	8.000	79.00	9085100078000
0.3110			7.900	8.000	79.00	9085100079000
0.3126	5/16		7.940	8.000	79.00	9085100079400
0.3150			8.000	8.000	79.00	9085100080000
0.3189			8.100	10.000	89.00	9085100081000
0.3228		P	8.200	10.000	89.00	9085100082000
0.3268			8.300	10.000	89.00	9085100083000
0.3280	21/64		8.330	10.000	89.00	9085100083300
0.3307			8.400	10.000	89.00	9085100084000
0.3346			8.500	10.000	89.00	9085100085000
0.3386			8.600	10.000	89.00	9085100086000
0.3425			8.700	10.000	89.00	9085100087000
0.3437	11/32		8.730	10.000	89.00	9085100087300
0.3465			8.800	10.000	89.00	9085100088000
0.3504			8.900	10.000	89.00	9085100089000
0.3543			9.000	10.000	89.00	9085100090000
0.3583			9.100	10.000	89.00	9085100091000
0.3594	23/64		9.130	10.000	89.00	9085100091300
0.3622			9.200	10.000	89.00	9085100092000
0.3642			9.250	10.000	89.00	9085100092500
0.3661			9.300	10.000	89.00	9085100093000
0.3701			9.400	10.000	89.00	9085100094000
0.3740			9.500	10.000	89.00	9085100095000
0.3748	3/8		9.520	10.000	89.00	9085100095200
0.3780			9.600	10.000	89.00	9085100096000
0.3819			9.700	10.000	89.00	9085100097000
0.3858		W	9.800	10.000	89.00	9085100098000
0.3898			9.900	10.000	89.00	9085100099000
0.3906	25/64		9.920	10.000	89.00	9085100099200
0.3937			10.000	10.000	89.00	9085100100000
0.3976			10.100	12.000	102.00	9085100101000
0.4016			10.200	12.000	102.00	9085100102000
0.4055			10.300	12.000	102.00	9085100103000
0.4063	13/32		10.320	12.000	102.00	9085100103200
0.4094			10.400	12.000	102.00	9085100104000
0.4134			10.500	12.000	102.00	9085100105000
0.4173			10.600	12.000	102.00	9085100106000
0.4213			10.700	12.000	102.00	9085100107000
0.4252			10.800	12.000	102.00	9085100108000
0.4291			10.900	12.000	102.00	9085100109000
0.4331			11.000	12.000	102.00	9085100110000
0.4370			11.100	12.000	102.00	9085100111000
0.4374	7/16		11.110	12.000	102.00	9085100111100
0.4409			11.200	12.000	102.00	9085100112000
0.4449			11.300	12.000	102.00	9085100113000

*Items listed in red are non-stocked items, and may take 2 - 6 weeks to receive

Series 8510

Speeds & Feeds information pg 501

Diameter (d1)							
Dec. inch	Fract. inch	Wire / letter	mm	d2 mm	l1 mm	l2 mm	EDP #
0.4488			11.400	12.000	102.00	55.00	9085100114000
0.4528			11.500	12.000	102.00	55.00	9085100115000
0.4567			11.600	12.000	102.00	55.00	9085100116000
0.4606			11.700	12.000	102.00	55.00	9085100117000
0.4646			11.800	12.000	102.00	55.00	9085100118000
0.4685			11.900	12.000	102.00	55.00	9085100119000
0.4689	15/32		11.910	12.000	102.00	55.00	9085100119100
0.4724			12.000	12.000	102.00	55.00	9085100120000
0.4803			12.200	14.000	107.00	60.00	9085100122000
0.4921			12.500	14.000	107.00	60.00	9085100125000
0.5000	1/2		12.700	14.000	107.00	60.00	9085100127000
0.5039			12.800	14.000	107.00	60.00	9085100128000
0.5118			13.000	14.000	107.00	60.00	9085100130000
0.5236			13.300	14.000	107.00	60.00	9085100133000
0.5315			13.500	14.000	107.00	60.00	9085100135000
0.5394			13.700	14.000	107.00	60.00	9085100137000
0.5512			14.000	14.000	107.00	60.00	9085100140000
0.5591			14.200	16.000	115.00	65.00	9085100142000
0.5626	9/16		14.290	16.000	115.00	65.00	9085100142900
0.5630			14.300	16.000	115.00	65.00	9085100143000
0.5709			14.500	16.000	115.00	65.00	9085100145000
0.5787			14.700	16.000	115.00	65.00	9085100147000
0.5906			15.000	16.000	115.00	65.00	9085100150000
0.5984			15.200	16.000	115.00	65.00	9085100152000

Diameter (d1)							
Dec. inch	Fract. inch	Wire / letter	mm	d2 mm	l1 mm	l2 mm	EDP #
0.6024			15.300	16.000	115.00	65.00	9085100153000
0.6102			15.500	16.000	115.00	65.00	9085100155000
0.6181			15.700	16.000	115.00	65.00	9085100157000
0.6299			16.000	16.000	115.00	65.00	9085100160000
0.6417			16.300	16.000	115.00	65.00	9085100163000
0.6496			16.500	18.000	123.00	73.00	9085100165000
0.6654			16.900	18.000	123.00	73.00	9085100169000
0.6693			17.000	18.000	131.00	79.00	9085100170000
0.6811			17.300	18.000	131.00	79.00	9085100173000
0.6890			17.500	18.000	131.00	79.00	9085100175000
0.7087			18.000	18.000	131.00	79.00	9085100180000
0.7283			18.500	20.000	131.00	79.00	9085100185000
0.7441			18.900	20.000	131.00	79.00	9085100189000
0.7480			19.000	20.000	131.00	79.00	9085100190000
0.7500			19.050	20.000	131.00	79.00	9085100190500
0.7598			19.300	20.000	131.00	79.00	9085100193000
0.7677			19.500	20.000	131.00	79.00	9085100195000
0.7874			20.000	20.000	131.00	79.00	9085100200000

Alternative Drill Series:

- #5510 Carbide, RT100, 3xD, 140 U pt, FIREX®
- #2477 Carbide, RT100U, 3xD, 140 U pt, nano-FIREX®

5xD

Series 8511

Application Materials:

- Universal Steels
- Stainless Steels
- Hardened Materials
- Ti & Ni Alloys

a

nano-A™ coated



Coolant Through



Reinforced Straight Shank

RT 100 VA High Penetration

Carbide, RT 100 VA, 5xD, self-centering
140° VA point, reinforced straight shank, RH helix

Cut Dia. = m7 tolerance range, Shank Dia. = h6

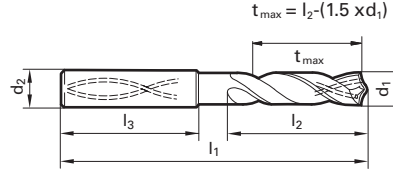

Speeds & Feeds information pg 501

Diameter (d1)			d2	l1	l2	EDP #
Dec. Inch	Fract. Inch	Wire / letter	mm	mm	mm	
0.1181			3.000	6.000	66.00	9085110030000
0.1220			3.100	6.000	66.00	9085110031000
0.1248	1/8		3.170	6.000	66.00	9085110031700
0.1260			3.200	6.000	66.00	9085110032000
0.1280			3.250	6.000	66.00	9085110032500
0.1299			3.300	6.000	66.00	9085110033000
0.1339			3.400	6.000	66.00	9085110034000
0.1378			3.500	6.000	66.00	9085110035000
0.1406	9/64	28	3.570	6.000	66.00	9085110035700
0.1417			3.600	6.000	66.00	9085110036000
0.1457			3.700	6.000	66.00	9085110037000
0.1496		25	3.800	6.000	74.00	9085110038000
0.1535			3.900	6.000	74.00	9085110039000
0.1563	5/32		3.970	6.000	74.00	9085110039700
0.1575			4.000	6.000	74.00	9085110040000
0.1614			4.100	6.000	74.00	9085110041000
0.1654			4.200	6.000	74.00	9085110042000
0.1693		18	4.300	6.000	74.00	9085110043000
0.1720	11/64		4.370	6.000	74.00	9085110043700
0.1732			4.400	6.000	74.00	9085110044000
0.1772		16	4.500	6.000	74.00	9085110045000
0.1811			4.600	6.000	74.00	9085110046000
0.1831			4.650	6.000	74.00	9085110046500
0.1850		13	4.700	6.000	74.00	9085110047000
0.1874	3/16		4.760	6.000	82.00	9085110047600
0.1890		12	4.800	6.000	82.00	9085110048000
0.1929			4.900	6.000	82.00	9085110049000
0.1969			5.000	6.000	82.00	9085110050000
0.2008			5.100	6.000	82.00	9085110051000
0.2031	13/64		5.160	6.000	82.00	9085110051600
0.2047			5.200	6.000	82.00	9085110052000
0.2087			5.300	6.000	82.00	9085110053000
0.2126			5.400	6.000	82.00	9085110054000
0.2165			5.500	6.000	82.00	9085110055000
0.2185			5.550	6.000	82.00	9085110055500
0.2189	7/32		5.560	6.000	82.00	9085110055600
0.2205			5.600	6.000	82.00	9085110056000
0.2244			5.700	6.000	82.00	9085110057000
0.2283			5.800	6.000	82.00	9085110058000
0.2323			5.900	6.000	82.00	9085110059000
0.2343	15/64		5.950	6.000	82.00	9085110059500
0.2362			6.000	6.000	82.00	9085110060000
0.2402			6.100	8.000	91.00	9085110061000
0.2441			6.200	8.000	91.00	9085110062000
0.2480			6.300	8.000	91.00	9085110063000
0.2500	1/4	E	6.350	8.000	91.00	9085110063500
0.2520			6.400	8.000	91.00	9085110064000
0.2559			6.500	8.000	91.00	9085110065000
0.2598			6.600	8.000	91.00	9085110066000
0.2638			6.700	8.000	91.00	9085110067000
0.2657	17/64	H	6.750	8.000	91.00	9085110067500
0.2677			6.800	8.000	91.00	9085110068000
0.2717		I	6.900	8.000	91.00	9085110069000
0.2756			7.000	8.000	91.00	9085110070000

Diameter (d1)			d2	l1	l2	EDP #
Dec. Inch	Fract. Inch	Wire / letter	mm	mm	mm	
0.2795			7.100	8.000	91.00	9085110071000
0.2811	9/32	K	7.140	8.000	91.00	9085110071400
0.2835			7.200	8.000	91.00	9085110072000
0.2874			7.300	8.000	91.00	9085110073000
0.2913			7.400	8.000	91.00	9085110074000
0.2953			7.500	8.000	91.00	9085110075000
0.2969	19/64		7.540	8.000	91.00	9085110075400
0.2992			7.600	8.000	91.00	9085110076000
0.3031			7.700	8.000	91.00	9085110077000
0.3071			7.800	8.000	91.00	9085110078000
0.3110			7.900	8.000	91.00	9085110079000
0.3126	5/16		7.940	8.000	91.00	9085110079400
0.3150			8.000	8.000	91.00	9085110080000
0.3189			8.100	10.000	103.00	9085110081000
0.3228		P	8.200	10.000	103.00	9085110082000
0.3268			8.300	10.000	103.00	9085110083000
0.3280	21/64		8.330	10.000	103.00	9085110083300
0.3307			8.400	10.000	103.00	9085110084000
0.3346			8.500	10.000	103.00	9085110085000
0.3386			8.600	10.000	103.00	9085110086000
0.3425			8.700	10.000	103.00	9085110087000
0.3437	11/32		8.730	10.000	103.00	9085110087300
0.3465			8.800	10.000	103.00	9085110088000
0.3504			8.900	10.000	103.00	9085110089000
0.3543			9.000	10.000	103.00	9085110090000
0.3583			9.100	10.000	103.00	9085110091000
0.3594	23/64		9.130	10.000	103.00	9085110091300
0.3622			9.200	10.000	103.00	9085110092000
0.3642			9.250	10.000	103.00	9085110092500
0.3661			9.300	10.000	103.00	9085110093000
0.3701			9.400	10.000	103.00	9085110094000
0.3740			9.500	10.000	103.00	9085110095000
0.3748	3/8		9.520	10.000	103.00	9085110095200
0.3780			9.600	10.000	103.00	9085110096000
0.3819			9.700	10.000	103.00	9085110097000
0.3858		W	9.800	10.000	103.00	9085110098000
0.3898			9.900	10.000	103.00	9085110099000
0.3906	25/64		9.920	10.000	103.00	9085110099200
0.3937			10.000	10.000	103.00	9085110100000
0.3976			10.100	12.000	118.00	9085110101000
0.4016			10.200	12.000	118.00	9085110102000
0.4055			10.300	12.000	118.00	9085110103000
0.4063	13/32		10.320	12.000	118.00	9085110103200
0.4094			10.400	12.000	118.00	9085110104000
0.4134			10.500	12.000	118.00	9085110105000
0.4173			10.600	12.000	118.00	9085110106000
0.4213			10.700	12.000	118.00	9085110107000
0.4252			10.800	12.000	118.00	9085110108000
0.4291			10.900	12.000	118.00	9085110109000
0.4331			11.000	12.000	118.00	9085110110000
0.4370			11.100	12.000	118.00	9085110111000
0.4374	7/16		11.110	12.000	118.00	9085110111100
0.4409			11.200	12.000	118.00	9085110112000
0.4449			11.300	12.000	118.00	9085110113000

*Items listed in red are non-stocked items, and may take 2 - 6 weeks to receive

Series 8511

Speeds & Feeds information pg 501

Diameter (d1)		d2 mm	l1 mm	l2 mm	EDP #
Dec. inch	Fract. inch				
0.4488		11.400	118.00	71.00	9085110114000
0.4528		11.500	118.00	71.00	9085110115000
0.4567		11.600	118.00	71.00	9085110116000
0.4606		11.700	118.00	71.00	9085110117000
0.4646		11.800	118.00	71.00	9085110118000
0.4685		11.900	118.00	71.00	9085110119000
0.4689	15/32	11.910	118.00	71.00	9085110119100
0.4724		12.000	118.00	71.00	9085110120000
0.4803		12.200	124.00	77.00	9085110122000
0.4921		12.500	124.00	77.00	9085110125000
0.5000	1/2	12.700	124.00	77.00	9085110127000
0.5039		12.800	124.00	77.00	9085110128000
0.5118		13.000	124.00	77.00	9085110130000
0.5236		13.300	124.00	77.00	9085110133000
0.5315		13.500	124.00	77.00	9085110135000
0.5394		13.700	124.00	77.00	9085110137000
0.5512		14.000	124.00	77.00	9085110140000
0.5591		14.200	133.00	83.00	9085110142000
0.5626	9/16	14.290	133.00	83.00	9085110142900
0.5630		14.300	133.00	83.00	9085110143000
0.5709		14.500	133.00	83.00	9085110145000
0.5787		14.700	133.00	83.00	9085110147000
0.5906		15.000	133.00	83.00	9085110150000
0.5984		15.200	133.00	83.00	9085110152000

Diameter (d1)		d2 mm	l1 mm	l2 mm	EDP #
Dec. inch	Fract. inch				
0.6024		15.300	133.00	83.00	9085110153000
0.6102		15.500	133.00	83.00	9085110155000
0.6181		15.700	133.00	83.00	9085110157000
0.6299		16.000	133.00	83.00	9085110160000
0.6417		16.300	143.00	93.00	9085110163000
0.6496		16.500	143.00	93.00	9085110165000
0.6654		16.900	143.00	93.00	9085110169000
0.6693		17.000	143.00	93.00	9085110170000
0.6811		17.300	143.00	93.00	9085110173000
0.6890		17.500	143.00	93.00	9085110175000
0.7087		18.000	143.00	93.00	9085110180000
0.7283		18.500	153.00	101.00	9085110185000
0.7441		18.900	153.00	101.00	9085110189000
0.7480		19.000	153.00	101.00	9085110190000
0.7500	3/4	19.050	153.00	101.00	9085110190500
0.7598		19.300	153.00	101.00	9085110193000
0.7677		19.500	153.00	101.00	9085110195000
0.7874		20.000	153.00	101.00	9085110200000

Alternative Drill Series:

- #5511 Carbide, RT100, 5xD, 140 U pt, FIREX®
- #2479 Carbide, RT100, 5xD, 140 U pt, nano-FIREX®
- #1662, Carbide, RT100, 5xD, 140 F pt, TiN

3xD

Series 8520

RT 100 HF High Penetration

Carbide, RT 100 HF, 3xD, double margin, self-centering
140° HF point, reinforced straight shank, RH helix

Application Materials:

-  Hardened Materials
-  Ti & Ni Alloys

Twist Drills

nano-Si™ coated



Coolant Through



Reinforced Straight Shank

Cut Dia. = m7 tolerance range, Shank Dia. = h6



$$t_{max} = l_2 - (1.5 \times d_1)$$

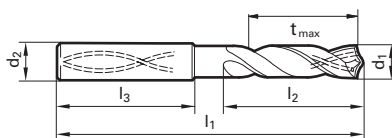

Speeds & Feeds
information pg 502

Diameter (d1)			d2 mm	l1 mm	l2 mm	EDP #
Dec. inch	Fract. inch	Wire / letter				
0.1181			3.00	62.00	20.00	9085200030000
0.1220			3.10	62.00	20.00	9085200031000
0.1248	1/8		3.17	62.00	20.00	9085200031700
0.1260			3.20	62.00	20.00	9085200032000
0.1280			3.25	62.00	20.00	9085200032500
0.1299			3.30	62.00	20.00	9085200033000
0.1339			3.40	62.00	20.00	9085200034000
0.1378			3.50	62.00	20.00	9085200035000
0.1406	9/64	28	3.57	62.00	20.00	9085200035700
0.1417			3.60	62.00	20.00	9085200036000
0.1457			3.70	62.00	20.00	9085200037000
0.1496		25	3.80	62.00	24.00	9085200038000
0.1535			3.90	62.00	24.00	9085200039000
0.1563	5/32		3.97	62.00	24.00	9085200039700
0.1575			4.00	62.00	24.00	9085200040000
0.1614			4.10	62.00	24.00	9085200041000
0.1654			4.20	62.00	24.00	9085200042000
0.1693		18	4.30	62.00	24.00	9085200043000
0.1720	11/64		4.37	62.00	24.00	9085200043700
0.1732			4.40	62.00	24.00	9085200044000
0.1772		16	4.50	62.00	24.00	9085200045000
0.1811			4.60	62.00	24.00	9085200046000
0.1831			4.65	62.00	24.00	9085200046500
0.1850		13	4.70	62.00	24.00	9085200047000
0.1874	3/16		4.76	62.00	28.00	9085200047600
0.1890		12	4.80	62.00	28.00	9085200048000
0.1929			4.90	62.00	28.00	9085200049000
0.1969			5.00	62.00	28.00	9085200050000
0.2008			5.10	62.00	28.00	9085200051000
0.2031	13/64		5.16	62.00	28.00	9085200051600
0.2047			5.20	62.00	28.00	9085200052000
0.2087			5.30	62.00	28.00	9085200053000
0.2126			5.40	62.00	28.00	9085200054000
0.2165			5.50	62.00	28.00	9085200055000
0.2185			5.55	62.00	28.00	9085200055500
0.2189	7/32		5.56	62.00	28.00	9085200055600
0.2205			5.60	62.00	28.00	9085200056000
0.2244			5.70	62.00	28.00	9085200057000
0.2283			5.80	62.00	28.00	9085200058000
0.2323			5.90	62.00	28.00	9085200059000
0.2343	15/64		5.95	62.00	28.00	9085200059500
0.2362			6.00	62.00	28.00	9085200060000
0.2402			6.10	80.00	79.00	9085200061000
0.2441			6.20	80.00	79.00	9085200062000
0.2480			6.30	80.00	79.00	9085200063000
0.2500	1/4	E	6.35	80.00	79.00	9085200063500
0.2520			6.40	80.00	79.00	9085200064000
0.2559			6.50	80.00	79.00	9085200065000
0.2598			6.60	80.00	79.00	9085200066000
0.2638			6.70	80.00	79.00	9085200067000
0.2657	17/64	H	6.75	80.00	79.00	9085200067500
0.2677			6.80	80.00	79.00	9085200068000
0.2717		I	6.90	80.00	79.00	9085200069000
0.2756			7.00	80.00	79.00	9085200070000

Diameter (d1)			d2 mm	l1 mm	l2 mm	EDP #
Dec. inch	Fract. inch	Wire / letter				
0.2795			7.10	79.00	41.00	9085200071000
0.2811	9/32	K	7.14	80.00	41.00	9085200071400
0.2835			7.20	80.00	41.00	9085200072000
0.2874			7.30	80.00	41.00	9085200073000
0.2913			7.40	80.00	41.00	9085200074000
0.2953			7.50	80.00	41.00	9085200075000
0.2969	19/64		7.54	80.00	41.00	9085200075400
0.2992			7.60	80.00	41.00	9085200076000
0.3031			7.70	80.00	41.00	9085200077000
0.3071			7.80	80.00	41.00	9085200078000
0.3110			7.90	80.00	41.00	9085200079000
0.3126	5/16		7.94	80.00	41.00	9085200079400
0.3150			8.00	80.00	41.00	9085200080000
0.3189			8.10	10.000	89.00	9085200081000
0.3228		P	8.20	10.000	89.00	9085200082000
0.3268			8.30	10.000	89.00	9085200083000
0.3280	21/64		8.33	10.000	89.00	9085200083300
0.3307			8.40	10.000	89.00	9085200084000
0.3346			8.50	10.000	89.00	9085200085000
0.3386			8.60	10.000	89.00	9085200086000
0.3425			8.70	10.000	89.00	9085200087000
0.3437	11/32		8.73	10.000	89.00	9085200087300
0.3465			8.80	10.000	89.00	9085200088000
0.3504			8.90	10.000	89.00	9085200089000
0.3543			9.00	10.000	89.00	9085200090000
0.3583			9.10	10.000	89.00	9085200091000
0.3594	23/64		9.13	10.000	89.00	9085200091300
0.3622			9.20	10.000	89.00	9085200092000
0.3642			9.25	10.000	89.00	9085200092500
0.3661			9.30	10.000	89.00	9085200093000
0.3701			9.40	10.000	89.00	9085200094000
0.3740			9.50	10.000	89.00	9085200095000
0.3748	3/8		9.52	10.000	89.00	9085200095200
0.3780			9.60	10.000	89.00	9085200096000
0.3819			9.70	10.000	89.00	9085200097000
0.3858		W	9.80	10.000	89.00	9085200098000
0.3898			9.90	10.000	89.00	9085200099000
0.3906	25/64		9.92	10.000	89.00	9085200099200
0.3937			10.00	10.000	89.00	9085200100000
0.3976			10.10	12.000	102.00	9085200101000
0.4016			10.20	12.000	102.00	9085200102000
0.4055			10.30	12.000	102.00	9085200103000
0.4063	13/32		10.32	12.000	102.00	9085200103200
0.4094			10.40	12.000	102.00	9085200104000
0.4134			10.50	12.000	102.00	9085200105000
0.4173			10.60	12.000	102.00	9085200106000
0.4213			10.70	12.000	102.00	9085200107000
0.4220	27/64		10.72	12.000	102.00	9085200107200
0.4252			10.80	12.000	102.00	9085200108000
0.4291			10.90	12.000	102.00	9085200109000
0.4331			11.00	12.000	102.00	9085200110000
0.4370			11.10	12.000	102.00	9085200111000
0.4374	7/16		11.11	12.000	102.00	9085200111100
0.4409			11.20	12.000	102.00	9085200112000

*Items listed in red are non-stocked items, and may take 2 - 6 weeks to receive

Series 8520

Speeds & Feeds information pg 502

Diameter (d1)				d2 mm	l1 mm	l2 mm	EDP #
Dec. inch	Fract. inch	Wire / letter	mm				
0.4449			11.30	12.000	102.00	55.00	9085200113000
0.4488			11.40	12.000	102.00	55.00	9085200114000
0.4528			11.50	12.000	102.00	55.00	9085200115000
0.4531	29/64		11.51	12.000	102.00	55.00	9085200115100
0.4567			11.60	12.000	102.00	55.00	9085200116000
0.4606			11.70	12.000	102.00	55.00	9085200117000
0.4646			11.80	12.000	102.00	55.00	9085200118000
0.4685			11.90	12.000	102.00	55.00	9085200119000
0.4689	15/32		11.91	12.000	102.00	55.00	9085200119100
0.4724			12.00	12.000	102.00	55.00	9085200120000
0.4803			12.20	14.000	107.00	60.00	9085200122000
0.4843	31/64		12.30	14.000	107.00	60.00	9085200123000
0.4921			12.50	14.000	107.00	60.00	9085200125000
0.5000	1/2		12.70	14.000	107.00	60.00	9085200127000
0.5039			12.80	14.000	107.00	60.00	9085200128000
0.5118			13.00	14.000	107.00	60.00	9085200130000
0.5236			13.30	14.000	107.00	60.00	9085200133000
0.5311	17/32		13.49	14.000	107.00	60.00	9085200134900
0.5315			13.50	14.000	107.00	60.00	9085200135000
0.5394			13.70	14.000	107.00	60.00	9085200137000
0.5512			14.00	14.000	107.00	60.00	9085200140000
0.5591			14.20	16.000	115.00	65.00	9085200142000
0.5626	9/16		14.29	16.000	115.00	65.00	9085200142900
0.5630			14.30	16.000	115.00	65.00	9085200143000
0.5709			14.50	16.000	115.00	65.00	9085200145000
0.5787			14.70	16.000	115.00	65.00	9085200147000
0.5906			15.00	16.000	115.00	65.00	9085200150000
0.5984			15.20	16.000	115.00	65.00	9085200152000

Diameter (d1)				d2 mm	l1 mm	l2 mm	EDP #
Dec. inch	Fract. inch	Wire / letter	mm				
0.6024			15.30	16.000	115.00	65.00	9085200153000
0.6102			15.50	16.000	115.00	65.00	9085200155000
0.6181			15.70	16.000	115.00	65.00	9085200157000
0.6248	5/8		15.87	16.000	115.00	65.00	9085200158700
0.6299			16.00	16.000	115.00	65.00	9085200160000
0.6417			16.30	16.000	115.00	65.00	9085200163000
0.6496			16.50	18.000	123.00	73.00	9085200165000
0.6654			16.90	18.000	123.00	73.00	9085200169000
0.6693			17.00	18.000	131.00	79.00	9085200170000
0.6811			17.30	18.000	131.00	79.00	9085200173000
0.6890			17.50	18.000	131.00	79.00	9085200175000
0.7087			18.00	18.000	131.00	79.00	9085200180000
0.7283			18.50	20.000	131.00	79.00	9085200185000
0.7441			18.90	20.000	131.00	79.00	9085200189000
0.7480			19.00	20.000	131.00	79.00	9085200190000
0.7500	3/4		19.05	20.000	131.00	79.00	9085200190500
0.7598			19.30	20.000	131.00	79.00	9085200193000
0.7677			19.50	20.000	131.00	79.00	9085200195000
0.7874			20.00	20.000	131.00	79.00	9085200200000

5xD

Series 8521

RT 100 HF High Penetration

Carbide, RT 100 HF, 5xD, double margin, self-centering
140° HF point, reinforced straight shank, RH helix

Application Materials:



Hardened Materials



Ti & Ni Alloys

nano-Si™ coated



Coolant Through



Reinforced Straight Shank

Cut Dia. = m7 tolerance range, Shank Dia. = h6

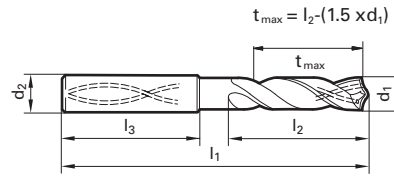

Speeds & Feeds
information pg 502

Diameter (d1)			d2 mm	l1 mm	l2 mm	EDP #
Dec. inch	Fract. inch	Wire / letter				
0.1181			3.00	66.00	28.00	9085210030000
0.1220			3.10	66.00	28.00	9085210031000
0.1248	1/8		3.17	66.00	28.00	9085210031700
0.1260			3.20	66.00	28.00	9085210032000
0.1280			3.25	66.00	28.00	9085210032500
0.1299			3.30	66.00	28.00	9085210033000
0.1339			3.40	66.00	28.00	9085210034000
0.1378			3.50	66.00	28.00	9085210035000
0.1406	9/64	28	3.57	66.00	28.00	9085210035700
0.1417			3.60	66.00	28.00	9085210036000
0.1457			3.70	66.00	28.00	9085210037000
0.1496		25	3.80	66.00	36.00	9085210038000
0.1535			3.90	66.00	36.00	9085210039000
0.1563	5/32		3.97	66.00	36.00	9085210039700
0.1575			4.00	66.00	36.00	9085210040000
0.1614			4.10	66.00	36.00	9085210041000
0.1654			4.20	66.00	36.00	9085210042000
0.1693		18	4.30	66.00	36.00	9085210043000
0.1720	11/64		4.37	66.00	36.00	9085210043700
0.1732			4.40	66.00	36.00	9085210044000
0.1772		16	4.50	66.00	36.00	9085210045000
0.1811			4.60	66.00	36.00	9085210046000
0.1831			4.65	66.00	36.00	9085210046500
0.1850		13	4.70	66.00	36.00	9085210047000
0.1874	3/16		4.76	66.00	44.00	9085210047600
0.1890		12	4.80	66.00	44.00	9085210048000
0.1929			4.90	66.00	44.00	9085210049000
0.1969			5.00	66.00	44.00	9085210050000
0.2008			5.10	66.00	44.00	9085210051000
0.2031	13/64		5.16	66.00	44.00	9085210051600
0.2047			5.20	66.00	44.00	9085210052000
0.2087			5.30	66.00	44.00	9085210053000
0.2126			5.40	66.00	44.00	9085210054000
0.2165			5.50	66.00	44.00	9085210055000
0.2185			5.55	66.00	44.00	9085210055500
0.2189	7/32		5.56	66.00	44.00	9085210055600
0.2205			5.60	66.00	44.00	9085210056000
0.2244			5.70	66.00	44.00	9085210057000
0.2283			5.80	66.00	44.00	9085210058000
0.2323			5.90	66.00	44.00	9085210059000
0.2343	15/64		5.95	66.00	44.00	9085210059500
0.2362			6.00	66.00	44.00	9085210060000
0.2402			6.10	66.00	53.00	9085210061000
0.2441			6.20	66.00	53.00	9085210062000
0.2480			6.30	66.00	53.00	9085210063000
0.2500	1/4	E	6.35	66.00	53.00	9085210063500
0.2520			6.40	66.00	53.00	9085210064000
0.2559			6.50	66.00	53.00	9085210065000
0.2598			6.60	66.00	53.00	9085210066000
0.2638			6.70	66.00	53.00	9085210067000
0.2657	17/64	H	6.75	66.00	53.00	9085210067500
0.2677			6.80	66.00	53.00	9085210068000
0.2717		I	6.90	66.00	53.00	9085210069000
0.2756			7.00	66.00	53.00	9085210070000

Diameter (d1)			d2 mm	l1 mm	l2 mm	EDP #
Dec. inch	Fract. inch	Wire / letter				
0.2795			7.10	91.00	53.00	9085210071000
0.2811	9/32	K	7.14	91.00	53.00	9085210071400
0.2835			7.20	91.00	53.00	9085210072000
0.2874			7.30	91.00	53.00	9085210073000
0.2913			7.40	91.00	53.00	9085210074000
0.2953			7.50	91.00	53.00	9085210075000
0.2969	19/64		7.54	91.00	53.00	9085210075400
0.2992			7.60	91.00	53.00	9085210076000
0.3031			7.70	91.00	53.00	9085210077000
0.3071			7.80	91.00	53.00	9085210078000
0.3110			7.90	91.00	53.00	9085210079000
0.3126	5/16		7.94	91.00	53.00	9085210079400
0.3150			8.00	91.00	53.00	9085210080000
0.3189			8.10	103.00	61.00	9085210081000
0.3228		P	8.20	103.00	61.00	9085210082000
0.3268			8.30	103.00	61.00	9085210083000
0.3280	21/64		8.33	103.00	61.00	9085210083300
0.3307			8.40	103.00	61.00	9085210084000
0.3346			8.50	103.00	61.00	9085210085000
0.3386			8.60	103.00	61.00	9085210086000
0.3425			8.70	103.00	61.00	9085210087000
0.3437	11/32		8.73	103.00	61.00	9085210087300
0.3465			8.80	103.00	61.00	9085210088000
0.3504			8.90	103.00	61.00	9085210089000
0.3543			9.00	103.00	61.00	9085210090000
0.3583			9.10	103.00	61.00	9085210091000
0.3594	23/64		9.13	103.00	61.00	9085210091300
0.3622			9.20	103.00	61.00	9085210092000
0.3642			9.25	103.00	61.00	9085210092500
0.3661			9.30	103.00	61.00	9085210093000
0.3701			9.40	103.00	61.00	9085210094000
0.3740			9.50	103.00	61.00	9085210095000
0.3748	3/8		9.52	103.00	61.00	9085210095200
0.3780			9.60	103.00	61.00	9085210096000
0.3819			9.70	103.00	61.00	9085210097000
0.3858		W	9.80	103.00	61.00	9085210098000
0.3898			9.90	103.00	61.00	9085210099000
0.3906	25/64		9.92	103.00	61.00	9085210099200
0.3937			10.00	103.00	61.00	9085210100000
0.3976			10.10	118.00	71.00	9085210101000
0.4016			10.20	118.00	71.00	9085210102000
0.4055			10.30	118.00	71.00	9085210103000
0.4063	13/32		10.32	118.00	71.00	9085210103200
0.4094			10.40	118.00	71.00	9085210104000
0.4134			10.50	118.00	71.00	9085210105000
0.4173			10.60	118.00	71.00	9085210106000
0.4213			10.70	118.00	71.00	9085210107000
0.4220	27/64		10.72	118.00	71.00	9085210107200
0.4252			10.80	118.00	71.00	9085210108000
0.4291			10.90	118.00	71.00	9085210109000
0.4331			11.00	118.00	71.00	9085210110000
0.4370			11.10	118.00	71.00	9085210111000
0.4374	7/16		11.11	118.00	71.00	9085210111100
0.4409			11.20	118.00	71.00	9085210112000

*Items listed in red are non-stocked items, and may take 2 - 6 weeks to receive

Series 8521

Speeds & Feeds information pg 502

Diameter (d1)			mm	d2 mm	l1 mm	l2 mm	EDP #
Dec. inch	Fract. inch	Wire / letter					
0.4449			11.30	12.000	118.00	71.00	9085210113000
0.4488			11.40	12.000	118.00	71.00	9085210114000
0.4528			11.50	12.000	118.00	71.00	9085210115000
0.4531	29/64		11.51	12.000	118.00	71.00	9085210115100
0.4567			11.60	12.000	118.00	71.00	9085210116000
0.4606			11.70	12.000	118.00	71.00	9085210117000
0.4646			11.80	12.000	118.00	71.00	9085210118000
0.4685			11.90	12.000	118.00	71.00	9085210119000
0.4689	15/32		11.91	12.000	118.00	71.00	9085210119100
0.4724			12.00	12.000	118.00	71.00	9085210120000
0.4803			12.20	14.000	124.00	77.00	9085210122000
0.4843	31/64		12.30	14.000	124.00	77.00	9085210123000
0.4921			12.50	14.000	124.00	77.00	9085210125000
0.5000	1/2		12.70	14.000	124.00	77.00	9085210127000
0.5039			12.80	14.000	124.00	77.00	9085210128000
0.5118			13.00	14.000	124.00	77.00	9085210130000
0.5236			13.30	14.000	124.00	77.00	9085210133000
0.5311	17/32		13.49	14.000	124.00	77.00	9085210134900
0.5315			13.50	14.000	124.00	77.00	9085210135000
0.5394			13.70	14.000	124.00	77.00	9085210137000
0.5512			14.00	14.000	124.00	77.00	9085210140000
0.5591			14.20	16.000	133.00	83.00	9085210142000
0.5626	9/16		14.29	16.000	133.00	83.00	9085210142900
0.5630			14.30	16.000	133.00	83.00	9085210143000
0.5709			14.50	16.000	133.00	83.00	9085210145000
0.5787			14.70	16.000	133.00	83.00	9085210147000
0.5906			15.00	16.000	133.00	83.00	9085210150000
0.5984			15.20	16.000	133.00	83.00	9085210152000

Diameter (d1)			mm	d2 mm	l1 mm	l2 mm	EDP #
Dec. inch	Fract. inch	Wire / letter					
0.6024			15.30	16.000	133.00	83.00	9085210153000
0.6102			15.50	16.000	133.00	83.00	9085210155000
0.6181			15.70	16.000	133.00	83.00	9085210157000
0.6248	5/8		15.87	16.000	133.00	83.00	9085210158700
0.6299			16.00	16.000	133.00	83.00	9085210160000
0.6417			16.30	16.000	133.00	83.00	9085210163000
0.6496			16.50	18.000	143.00	93.00	9085210165000
0.6654			16.90	18.000	143.00	93.00	9085210169000
0.6693			17.00	18.000	143.00	93.00	9085210170000
0.6811			17.30	18.000	143.00	93.00	9085210173000
0.6890			17.50	18.000	143.00	93.00	9085210175000
0.7087			18.00	18.000	143.00	93.00	9085210180000
0.7283			18.50	18.000	143.00	93.00	9085210185000
0.7441			18.90	20.000	153.00	101.00	9085210189000
0.7480			19.00	20.000	153.00	101.00	9085210190000
0.7500	3/4		19.05	20.000	153.00	101.00	9085210190500
0.7598			19.30	20.000	153.00	101.00	9085210193000
0.7677			19.50	20.000	153.00	101.00	9085210195000
0.7874			20.00	20.000	153.00	101.00	9085210200000

7xD

Series 8522

RT 100 HF High Penetration

Carbide, RT 100 HF, 7xD, double margin, self-centering
140° HF point, reinforced straight shank, RH helix

Cut Dia. = m7 tolerance range, Shank Dia. = h6

Application Materials:



Hardened Materials



Ti & Ni Alloys

Twist Drills

nano-Si™ coated



Coolant Through



Reinforced Straight Shank

Speeds & Feeds
information pg 503

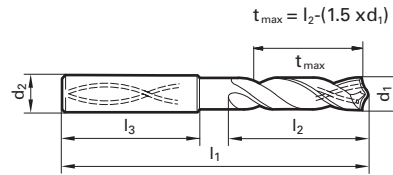

Diameter (d1)			d2 mm	l1 mm	l2 mm	EDP #
Dec. inch	Fract. inch	Wire / letter				
0.1181			3.00	6.000	70.00	9085220030000
0.1248	1/8		3.17	6.000	70.00	9085220031700
0.1280			3.25	6.000	70.00	9085220032500
0.1299			3.30	6.000	70.00	9085220033000
0.1339			3.40	6.000	75.00	9085220034000
0.1378			3.50	6.000	75.00	9085220035000
0.1406	9/64	28	3.57	6.000	75.00	9085220035700
0.1457			3.70	6.000	75.00	9085220037000
0.1563	5/32		3.97	6.000	75.00	9085220039700
0.1575			4.00	6.000	75.00	9085220040000
0.1654			4.20	6.000	75.00	9085220042000
0.1693		18	4.30	6.000	85.00	9085220043000
0.1720	11/64		4.37	6.000	85.00	9085220043700
0.1772			4.50	6.000	85.00	9085220045000
0.1831			4.65	6.000	85.00	9085220046500
0.1874	3/16		4.76	6.000	90.00	9085220047600
0.1969			5.00	6.000	90.00	9085220050000
0.2008			5.10	6.000	90.00	9085220051000
0.2031	13/64		5.16	6.000	90.00	9085220051600
0.2047			5.20	6.000	90.00	9085220052000
0.2165			5.50	6.000	97.00	9085220055000
0.2185			5.55	6.000	97.00	9085220055500
0.2189	7/32		5.56	6.000	97.00	9085220055600
0.2343	15/64		5.95	6.000	97.00	9085220059500
0.2362			6.00	6.000	97.00	9085220060000
0.2500	1/4	E	6.35	8.000	106.00	9085220063500
0.2559			6.50	8.000	106.00	9085220065000
0.2571		F	6.53	8.000	106.00	9085220065300
0.2657	17/64	H	6.75	8.000	106.00	9085220067500
0.2677			6.80	8.000	106.00	9085220068000
0.2717		I	6.90	8.000	116.00	9085220069000
0.2756			7.00	8.000	116.00	9085220070000
0.2811	9/32	K	7.14	8.000	116.00	9085220071400
0.2913			7.40	8.000	116.00	9085220074000
0.2953			7.50	8.000	116.00	9085220075000
0.2969	19/64		7.54	8.000	116.00	9085220075400
0.3071			7.80	8.000	116.00	9085220078000
0.3126	5/16		7.94	8.000	116.00	9085220079400
0.3150			8.00	8.000	116.00	9085220080000
0.3280	21/64		8.33	10.000	131.00	9085220083300
0.3346			8.50	10.000	131.00	9085220085000

Diameter (d1)			d2 mm	l1 mm	l2 mm	EDP #
Dec. inch	Fract. inch	Wire / letter				
0.3386			8.60	10.000	131.00	9085220086000
0.3437	11/32		8.73	10.000	131.00	9085220087300
0.3465			8.80	10.000	131.00	9085220088000
0.3543			9.00	10.000	131.00	9085220090000
0.3594	23/64		9.13	10.000	139.00	9085220091300
0.3642			9.25	10.000	139.00	9085220092500
0.3677		U	9.340	10.000	139.00	9085220093400
0.3701			9.40	10.000	139.00	9085220094000
0.3740			9.50	10.000	139.00	9085220095000
0.3748	3/8		9.52	10.000	139.00	9085220095200
0.3906	25/64		9.92	10.000	139.00	9085220099200
0.3937			10.00	10.000	139.00	9085220100000
0.4016			10.20	12.000	155.00	9085220102000
0.4063	13/32		10.32	12.000	155.00	9085220103200
0.4094			10.40	12.000	155.00	9085220104000
0.4134			10.50	12.000	155.00	9085220105000
0.4252			10.80	12.000	155.00	9085220108000
0.4331			11.00	12.000	155.00	9085220110000
0.4374	7/16		11.11	12.000	163.00	9085220111100
0.4449			11.30	12.000	155.00	9085220113000
0.4488			11.40	12.000	155.00	9085220114000
0.4528			11.50	12.000	163.00	9085220115000
0.4531			11.51	12.000	155.00	9085220115100
0.4689	15/32		11.91	12.000	163.00	9085220119100
0.4724			12.00	12.000	163.00	9085220120000
0.4843	31/64		12.30	14.000	182.00	9085220123000
0.4921			12.50	14.000	182.00	9085220125000
0.5000	1/2		12.70	14.000	182.00	9085220127000
0.5118			13.00	14.000	182.00	9085220130000
0.5157			13.10	14.000	182.00	9085220131000
0.5311			13.49	14.000	182.00	9085220134900
0.5315			13.50	14.000	182.00	9085220135000
0.5512			14.00	14.000	182.00	9085220140000
0.5626	9/16		14.29	16.000	204.00	9085220142900
0.5709			14.50	16.000	204.00	9085220145000
0.5906			15.00	16.000	204.00	9085220150000
0.5945			15.10	16.000	204.00	9085220151000
0.6102			15.50	16.000	204.00	9085220155000
0.6248	5/8		15.87	16.000	204.00	9085220158700
0.6299			16.00	16.000	204.00	9085220160000

*Items listed in red are non-stocked items, and may take 2 - 6 weeks to receive

3xD**Series 8524**

Application Materials:

**RT 100 HF High Penetration**

Carbide, RT 100 HF, 3xD, double margin, self-centering
140° HF point, reinforced straight shank, RH helix

nano-Si™ coated



External Coolant



Reinforced Straight Shank

Speeds & Feeds
information pg 503

Cut Dia. = m7 tolerance range, Shank Dia. = h6

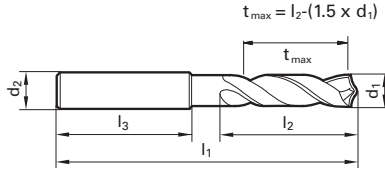

Diameter (d1)			d2 mm	l1 mm	l2 mm	EDP #
Dec. inch	Fract. inch	Wire / letter				
0.1181			3.00	62.00	20.00	9085240030000
0.1220			3.10	62.00	20.00	9085240031000
0.1248	1/8		3.17	62.00	20.00	9085240031700
0.1260			3.20	62.00	20.00	9085240032000
0.1280			3.25	62.00	20.00	9085240032500
0.1299			3.30	62.00	20.00	9085240033000
0.1339			3.40	62.00	20.00	9085240034000
0.1378			3.50	62.00	20.00	9085240035000
0.1406	9/64	28	3.57	62.00	20.00	9085240035700
0.1417			3.60	62.00	20.00	9085240036000
0.1457			3.70	62.00	20.00	9085240037000
0.1496		25	3.80	66.00	24.00	9085240038000
0.1535			3.90	66.00	24.00	9085240039000
0.1563	5/32		3.97	66.00	24.00	9085240039700
0.1575			4.00	66.00	24.00	9085240040000
0.1614			4.10	66.00	24.00	9085240041000
0.1654			4.20	66.00	24.00	9085240042000
0.1693		18	4.30	66.00	24.00	9085240043000
0.1720	11/64		4.37	66.00	24.00	9085240043700
0.1732			4.40	66.00	24.00	9085240044000
0.1772		16	4.50	66.00	24.00	9085240045000
0.1811			4.60	66.00	24.00	9085240046000
0.1831			4.65	66.00	24.00	9085240046500
0.1850		13	4.70	66.00	24.00	9085240047000
0.1874	3/16		4.76	66.00	28.00	9085240047600
0.1890		12	4.80	66.00	28.00	9085240048000
0.1929			4.90	66.00	28.00	9085240049000
0.1969			5.00	66.00	28.00	9085240050000
0.2008			5.10	66.00	28.00	9085240051000
0.2031	13/64		5.16	66.00	28.00	9085240051600
0.2047			5.20	66.00	28.00	9085240052000
0.2087			5.30	66.00	28.00	9085240053000
0.2126			5.40	66.00	28.00	9085240054000
0.2165			5.50	66.00	28.00	9085240055000
0.2185			5.55	66.00	28.00	9085240055500
0.2189	7/32		5.56	66.00	28.00	9085240055600
0.2205			5.60	66.00	28.00	9085240056000
0.2244			5.70	66.00	28.00	9085240057000
0.2283			5.80	66.00	28.00	9085240058000
0.2323			5.90	66.00	28.00	9085240059000
0.2343	15/64		5.95	66.00	28.00	9085240059500
0.2362			6.00	66.00	28.00	9085240060000
0.2402			6.10	8.000	79.00	9085240061000
0.2441			6.20	8.000	79.00	9085240062000
0.2480			6.30	8.000	79.00	9085240063000
0.2500	1/4	E	6.35	8.000	79.00	9085240063500
0.2520			6.40	8.000	79.00	9085240064000
0.2559			6.50	8.000	79.00	9085240065000
0.2598			6.60	8.000	79.00	9085240066000
0.2638			6.70	8.000	79.00	9085240067000
0.2657	17/64	H	6.75	8.000	79.00	9085240067500
0.2677			6.80	8.000	79.00	9085240068000
0.2717		I	6.90	8.000	79.00	9085240069000
0.2756			7.00	8.000	79.00	9085240070000

Diameter (d1)			d2 mm	l1 mm	l2 mm	EDP #
Dec. inch	Fract. inch	Wire / letter				
0.2795			7.10	79.00	34.00	9085240071000
0.2811	9/32	K	7.14	8.000	79.00	9085240071400
0.2835			7.20	8.000	79.00	9085240072000
0.2874			7.30	8.000	79.00	9085240073000
0.2913			7.40	8.000	79.00	9085240074000
0.2953			7.50	8.000	79.00	9085240075000
0.2969	19/64		7.54	8.000	79.00	9085240075400
0.2992			7.60	8.000	79.00	9085240076000
0.3031			7.70	8.000	79.00	9085240077000
0.3071			7.80	8.000	79.00	9085240078000
0.3110			7.90	8.000	79.00	9085240079000
0.3126	5/16		7.94	8.000	79.00	9085240079400
0.3150			8.00	8.000	79.00	9085240080000
0.3189			8.10	10.000	89.00	9085240081000
0.3228		P	8.20	10.000	89.00	9085240082000
0.3268			8.30	10.000	89.00	9085240083000
0.3280	21/64		8.33	10.000	89.00	9085240083300
0.3307			8.40	10.000	89.00	9085240084000
0.3346			8.50	10.000	89.00	9085240085000
0.3386			8.60	10.000	89.00	9085240086000
0.3425			8.70	10.000	89.00	9085240087000
0.3437	11/32		8.73	10.000	89.00	9085240087300
0.3465			8.80	10.000	89.00	9085240088000
0.3504			8.90	10.000	89.00	9085240089000
0.3543			9.00	10.000	89.00	9085240090000
0.3583			9.10	10.000	89.00	9085240091000
0.3594	23/64		9.13	10.000	89.00	9085240091300
0.3622			9.20	10.000	89.00	9085240092000
0.3642			9.25	10.000	89.00	9085240092500
0.3661			9.30	10.000	89.00	9085240093000
0.3701			9.40	10.000	89.00	9085240094000
0.3740			9.50	10.000	89.00	9085240095000
0.3748	3/8		9.52	10.000	89.00	9085240095200
0.3780			9.60	10.000	89.00	9085240096000
0.3819			9.70	10.000	89.00	9085240097000
0.3858		W	9.80	10.000	89.00	9085240098000
0.3898			9.90	10.000	89.00	9085240099000
0.3906	25/64		9.92	10.000	89.00	9085240099200
0.3937			10.00	10.000	89.00	9085240100000
0.3976			10.10	12.000	102.00	9085240101000
0.4016			10.20	12.000	102.00	9085240102000
0.4055			10.30	12.000	102.00	9085240103000
0.4063	13/32		10.32	12.000	102.00	9085240103200
0.4094			10.40	12.000	102.00	9085240104000
0.4134			10.50	12.000	102.00	9085240105000
0.4173			10.60	12.000	102.00	9085240106000
0.4213			10.70	12.000	102.00	9085240107000
0.4220	27/64		10.72	12.000	102.00	9085240107200
0.4252			10.80	12.000	102.00	9085240108000
0.4291			10.90	12.000	102.00	9085240109000
0.4331			11.00	12.000	102.00	9085240110000
0.4370			11.10	12.000	102.00	9085240111000
0.4374	7/16		11.11	12.000	102.00	9085240111100
0.4409			11.20	12.000	102.00	9085240112000

Series 8524

Speeds & Feeds information pg 503

Diameter (d1)							
Dec. inch	Fract. inch	Wire / letter	mm	d2 mm	l1 mm	l2 mm	EDP #
0.4449			11.30	12.000	102.00	55.00	9085240113000
0.4488			11.40	12.000	102.00	55.00	9085240114000
0.4528			11.50	12.000	102.00	55.00	9085240115000
0.4531	29/64		11.51	12.000	102.00	55.00	9085240115100
0.4567			11.60	12.000	102.00	55.00	9085240116000
0.4606			11.70	12.000	102.00	55.00	9085240117000
0.4646			11.80	12.000	102.00	55.00	9085240118000
0.4685			11.90	12.000	102.00	55.00	9085240119000
0.4689	15/32		11.91	12.000	102.00	55.00	9085240119100
0.4724			12.00	12.000	102.00	55.00	9085240120000
0.4803			12.20	14.000	107.00	60.00	9085240122000
0.4843	31/64		12.30	14.000	107.00	60.00	9085240123000
0.4921			12.50	14.000	107.00	60.00	9085240125000
0.5000	1/2		12.70	14.000	107.00	60.00	9085240127000
0.5039			12.80	14.000	107.00	60.00	9085240128000
0.5118			13.00	14.000	107.00	60.00	9085240130000
0.5236			13.30	14.000	107.00	60.00	9085240133000
0.5311	17/32		13.49	14.000	107.00	60.00	9085240134900
0.5315			13.50	14.000	107.00	60.00	9085240135000
0.5394			13.70	14.000	107.00	60.00	9085240137000
0.5512			14.00	14.000	107.00	60.00	9085240140000
0.5591			14.20	16.000	115.00	65.00	9085240142000
0.5626	9/16		14.29	16.000	107.00	60.00	9085240142900
0.5630			14.30	16.000	115.00	65.00	9085240143000
0.5709			14.50	16.000	115.00	65.00	9085240145000
0.5787			14.70	16.000	115.00	65.00	9085240147000
0.5906			15.00	16.000	115.00	65.00	9085240150000
0.5984			15.20	16.000	115.00	65.00	9085240152000

Diameter (d1)							
Dec. inch	Fract. inch	Wire / letter	mm	d2 mm	l1 mm	l2 mm	EDP #
0.6024			15.30	16.000	115.00	65.00	9085240153000
0.6102			15.50	16.000	115.00	65.00	9085240155000
0.6181			15.70	16.000	115.00	65.00	9085240157000
0.6248	5/8		15.87	16.000	115.00	65.00	9085240158700
0.6299			16.00	16.000	115.00	65.00	9085240160000
0.6417			16.30	18.000	123.00	73.00	9085240163000
0.6496			16.50	18.000	123.00	73.00	9085240165000
0.6654			16.90	18.000	123.00	73.00	9085240169000
0.6693			17.00	18.000	123.00	73.00	9085240170000
0.6811			17.30	18.000	123.00	73.00	9085240173000
0.6890			17.50	18.000	123.00	73.00	9085240175000
0.7087			18.00	18.000	123.00	73.00	9085240180000
0.7283			18.50	20.000	131.00	79.00	9085240185000
0.7441			18.90	20.000	131.00	79.00	9085240189000
0.7480			19.00	20.000	131.00	79.00	9085240190000
0.7500	3/4		19.05	20.000	131.00	79.00	9085240190500
0.7598			19.30	20.000	131.00	79.00	9085240193000
0.7677			19.50	20.000	131.00	79.00	9085240195000
0.7874			20.00	20.000	131.00	79.00	9085240200000

*Items listed in red are non-stocked items, and may take 2 - 6 weeks to receive



Holfelder-Guhring Cutting Tools

Are you looking for a competent partner for μ -accurate adjustable precision tools? Contact us! Thanks to precision solutions for axial and radial adjustment, Holfelder-Guhring Cutting Tools supplies standard tools for milling, turning and countersinking as well as complex customer-specific solutions.

Hollfelder-Guhring Cutting Tools

The new Drill / Chamfering units are versatile - can be applied in a wide variety of machining tasks and workpiece materials.

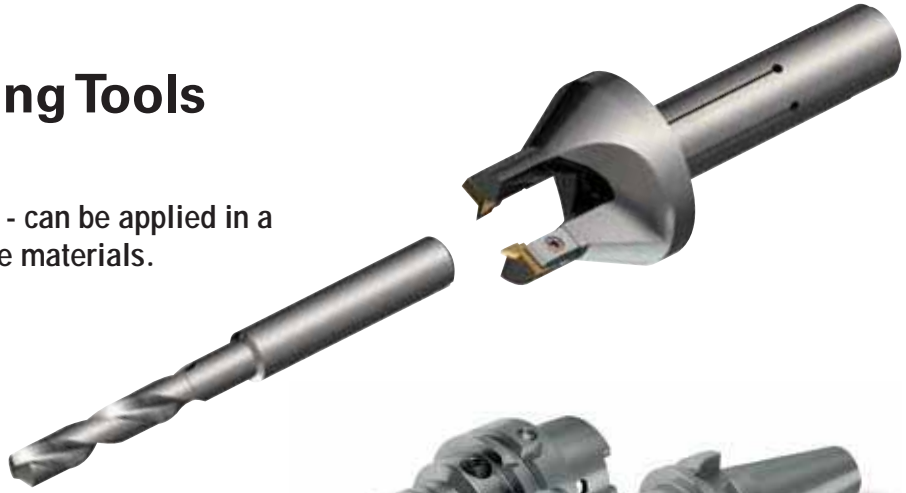

Features:

Use in standard hydraulic expansion chucks



Use with standard RT 100 style solid carbide drills or comparable drills (DIN 6537 L/K)

3 different chamfering angles available as standard

Standard inserts in carbide (uncoated and coated); PCD inserts available

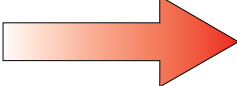

Benefits:

- | | | |
|---|---|--|
| High runout accuracy due to use in hydraulic expansion chucks |  | High tool life on drills and inserts |
| One tool holder for different chamfering angles |  | Reduced amount of tool bodies |
| Easy handling, assembly and setup |  | Reduced non-productive times |
| Suitable for all standard hydraulic expansion chucks |  | No additional costs for special chucks |

Drill/Chamfer Units

Possible drill-adapter combinations

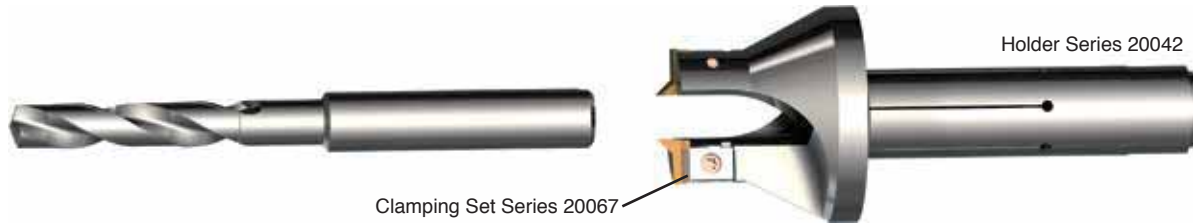

Part number	chamfer FB	Insert (see page 234)	SL max	SL min	Drill Ø B	Drill 3xD RT 100 style DIN 6537 K			Drill 5xD RT 100 style DIN 6537 L			Drill 7xD RT 100 style		
						from	-	to	from	-	to	from	-	to
H 2006-1206 0000 R	1.8	W 2006-..... L	59.3	50.3	4.0 - 4.2	6.7	-	15.7	14.7	-	23.7	15.7	-	24.7
					4.3 - 4.7	6.7	-	15.7	14.7	-	23.7	25.7	-	34.7
					4.8 - 5.3	6.7	-	15.7	22.7	-	31.7	30.7	-	39.7
					5.4 - 6.0	6.7	-	15.7	22.7	-	31.7	37.7	-	46.7
H 2006-1208 0000 R	1.8	W 2006-..... L	59.3	50.3	6.1 - 7.0	19.7	-	24.8	31.7	-	40.7	46.7	-	55.7
					7.1 - 8.0	19.7	-	28.7	31.7	-	40.7	56.7	-	65.7
H 2006-2006 0000 R	1.8	W 2006-..... L	62.8	52.8	4.0 - 4.2	3.2	-	13.2	11.2	-	21.2	12.2	-	22.2
					4.3 - 4.7	3.2	-	13.2	11.2	-	21.2	22.2	-	32.2
					4.8 - 5.3	3.2	-	13.2	19.2	-	29.2	27.2	-	37.2
					5.4 - 6.0	3.2	-	13.2	19.2	-	29.2	34.2	-	44.2
H 2006-2008 0000 R	1.8	W 2006-..... L	62.8	52.8	6.1 - 7.0	16.2	-	24.8	28.2	-	38.2	43.2	-	53.2
					7.1 - 8.0	16.2	-	26.2	28.2	-	38.2	53.2	-	63.2
H 2006-2010 0000 R	1.8	W 2006-..... L	67.8	57.8	8.1 - 9.0	21.2	-	31.2	35.2	-	45.2	63.2	-	73.2
					9.1 - 10.0	21.2	-	31.2	35.2	-	45.2	71.2	-	81.2
H 2006-2012 0000 R	1.8	W 2006-..... L	72.8	62.8	10.1 - 11.0	29.2	-	39.2	0.5	-	10.5	82.2	-	92.2
					11.1 - 12.0	29.2	-	39.2	45.2	-	55.2	90.2	-	99.5
H 3006-2014 0000 R	2.5	W 3006-..... L	73.5	63.5	12.1 - 14.0	33.5	-	41.5	50.5	-	58.5	108.5	-	116
H 3006-2016 0000 R	2.5	W 3006-..... L	73.5	63.5	14.1 - 16.0	41.5	-	43.9	59.5	-	61.9	130.5	-	132.6
H 2006-3206 0000 R	1.8	W 2006-..... L	64.8	54.8	4.0 - 4.2	1.2	-	11.2	9.2	-	19.2	10.2	-	20.2
					4.3 - 4.7	1.2	-	11.2	9.2	-	19.2	20.2	-	30.2
					4.8 - 5.3	1.2	-	11.2	17.2	-	27.2	25.2	-	35.2
					5.4 - 6.0	1.2	-	11.2	17.2	-	27.2	32.2	-	42.2
H 2006-3208 0000 R	1.8	W 2006-..... L	64.8	54.8	6.1 - 7.0	14.2	-	24.2	26.2	-	36.2	41.2	-	51.2
					7.1 - 8.0	14.2	-	24.2	26.2	-	36.2	51.2	-	61.2
H 2006-3210 0000 R	1.8	W 2006-..... L	69.8	59.8	8.1 - 9.0	19.2	-	29.2	33.2	-	43.2	61.2	-	71.2
					9.1 - 10.0	19.2	-	29.2	33.2	-	43.2	69.2	-	79.2
H 2006-3212 0000 R	1.8	W 2006-..... L	74.8	64.8	10.1 - 11.0	27.2	-	37.2	43.2	-	53.2	80.2	-	90.2
					11.1 - 12.0	27.2	-	37.2	43.2	-	53.2	88.2	-	98.2
H 3006-3214 0000 R	2.5	W 3006-..... L	75.5	65.5	12.1 - 14.0	31.5	-	41.5	48.5	-	58.5	106.5	-	116
H 3006-3216 0000 R	2.5	W 3006-..... L	80.5	70.5	14.1 - 16.0	34.5	-	43.9	52.5	-	62.5	123.5	-	132.6
H 3006-3218 0000 R	2.5	W 3006-..... L	80.5	70.5	16.1 - 18.0	42.5	-	49.3	62.5	-	69.3	142.5	-	149.2
H 3006-3220 0000 R	2.5	W 3006-..... L	80.5	70.5	18.1 - 20.0	50.5	-	52.6	72.5	-	74.6	163.5	-	165.8

Ordering example:

Drill-Ø = 6.2 mm, Drilling depth = 22 mm, Chamfer = 1x45°, Hydraulic chuck-Ø = 20mm
 reading from the table: Drawing number = H 2006-2008 000 R, the drawing number reading from
 the table of the right side shows the Ordering number = Series No. + Code = 20042 8.020

Drill/Chamfer Units

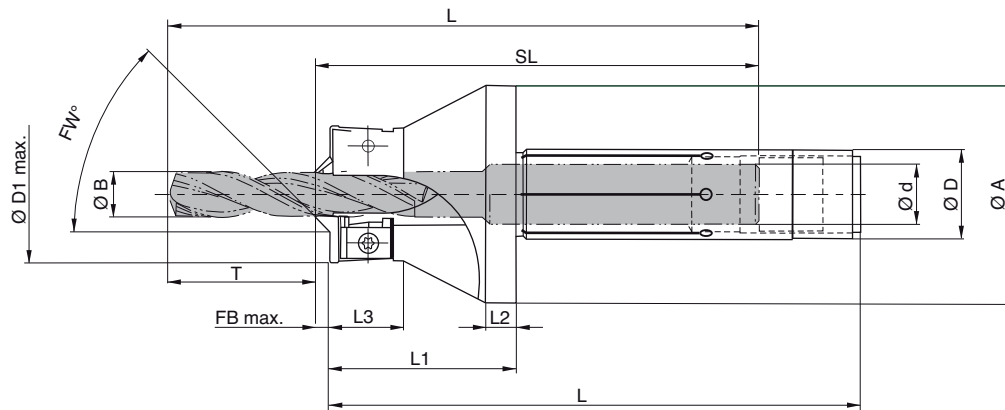

all dimensions in mm

Series no. 20042	Part number	Drill range Ø B	Chamfer FB max.	Holder shank Ø D	Drill shank Ø d	Ø A	L	L1	L2	L3	Ø D _{1max}	Insert (next page)
6.012	H 2006-1206 0000 R	4.0- 6	1.8	12	6	29	70	25	4	10	18.3	W 2006-..... L
8.012	H 2006-1208 0000 R	6.1- 8	1.8	12	8	29	70	25	4	10	20.2	W 2006-..... L
6.020	H 2006-2006 0000 R	4.0- 6	1.8	20	6	35	75	25	4	10	18.5	W 2006-..... L
8.020	H 2006-2008 0000 R	6.1- 8	1.8	20	8	35	75	25	4	10	20.2	W 2006-..... L
10.020	H 2006-2010 0000 R	8.1- 10	1.8	20	10	35	75	25	4	10	22.2	W 2006-..... L
12.020	H 2006-2012 0000 R	10.1- 12	1.8	20	12	35	75	25	4	10	24.4	W 2006-..... L
6.032	H 2006-3206 0000 R	4.0- 6	1.8	32	6	46	90	30	5	10	18.3	W 2006-..... L
8.032	H 2006-3208 0000 R	6.1- 8	1.8	32	8	46	90	30	5	10	20.2	W 2006-..... L
10.032	H 2006-3210 0000 R	8.1- 10	1.8	32	10	46	90	30	5	10	22.4	W 2006-..... L
12.032	H 2006-3212 0000 R	10.1- 12	1.8	32	12	46	90	30	5	10	24.4	W 2006-..... L
14.020	H 3006-2014 0000 R	12.1- 14	2.5	20	14	35	75	25	4	12	31.7	W 3006-..... L
16.020	H 3006-2016 0000 R	14.1- 16	2.5	20	16	35	75	25	4	12	33.6	W 3006-..... L
14.032	H 3006-3214 0000 R	12.1- 14	2.5	32	14	46	90	30	5	12	31.7	W 3006-..... L
16.032	H 3006-3216 0000 R	14.1- 16	2.5	32	16	46	90	30	5	12	33.6	W 3006-..... L
18.032	H 3006-3218 0000 R	16.1- 18	2.5	32	18	46	90	30	5	12	35.5	W 3006-..... L
20.032	H 3006-3220 0000 R	18.1- 20	2.5	32	20	46	90	30	5	12	37.7	W 3006-..... L

Spare parts

Series no. 20067	Code	Drawing number	Clamping set for	Tx
	2.000	E4890	H 2006-...	6
	2.500	E4991	H 3006-...	8

Ordering example:

Series number + Code = Ordering number

e.g. Clamping set for H 2006-... = Ordering number 20067 2.000

Drill/Chamfer Units

Carbide inserts, uncoated / coated

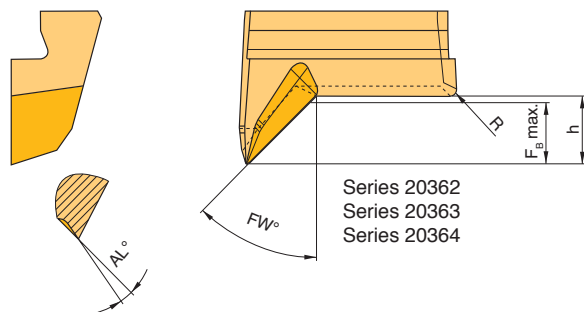

PCD inserts

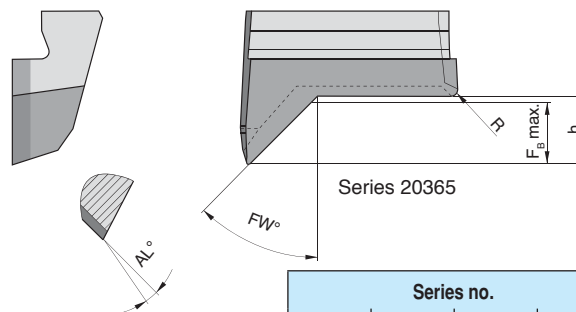

all dimensions in mm

Code	Part no.	F _b max max. Chamfer width	FW° Chamfer angle	AL° Rake angle	R Radius	h Height	Series no.			
							20362	20363	20364	20365
							Cutting grade			
							K10	G12	G16	PCD
20.060	W 2006-1830 1000 L	1.8	30°	10°	0.2	2	•	•	•	
20.060	W 2006-1830 0000 L	1.8	30°	0°	0.2	2				•
20.061	W 2006-1845 1000 L	1.8	45°	10°	0.2	2	•	•	•	
20.061	W 2006-1845 0000 L	1.8	45°	0°	0.2	2				•
20.062	W 2006-1860 1000 L	1.8	60°	10°	0.2	2	•	•	•	
20.062	W 2006-1860 0000 L	1.8	60°	0°	0.2	2				•
30.063	W 3006-2530 1000 L	2.5	30°	10°	0.2	2.7	•	•	•	
30.063	W 3006-2530 0000 L	2.5	30°	0°	0.2	2.7				•
30.064	W 3006-2545 1000 L	2.5	45°	10°	0.2	2.7	•	•	•	
30.064	W 3006-2545 0000 L	2.5	45°	0°	0.2	2.7				•
30.065	W 3006-2560 1000 L	2.5	60°	10°	0.2	2.7	•	•	•	
30.065	W 3006-2560 0000 L	2.5	60°	0°	0.2	2.7				•

• ex stock

Application recommendations

Cutting material	Grade composition		Workpiece material				
	Substrate	Coating	Steel	Stainless steel	Cast iron	Non ferrous materials	Heavy machinable materials
K10 With chipbreaker	K10	uncoated			●	▲	●
G12 With chipbreaker	K10	TiAlN Multilayer PVD			▲	●	
G16 With chipbreaker	P20	TiAlN Multilayer PVD	▲	▲			●
PCD Without chipbreaker	Grain size 10 μm					▲	

▲ = well suited ● = applicable Further cutting material, coatings and geometries on request.

Drill/Chamfer Inserts

The cutting data recommendations in the table are guide values and depend to a high degree on the stability of the machine, fixture and workpiece.

Cutting group	Material group	Composition / Structure	Tensile strength		Cutting speed v_c m/min	Recommended cutting grade	Feed rate f_z mm/z	
			RM (MPa)	HB HRC			W 2006-....	W 3006-....
1.1	Unalloyed steel	C = 0,1 -0,25 annealed, long cut	420	125	100-160	G16	0.05-0.15	0.07-0.15
1.2		C = 0,1 -0,25 annealed, short chip	420	125	110-160			
2.1		C = 0,25 -0,55 annealed, long cut	620	190	90-150			
2.2		C = 0,25 -0,55 annealed, short chip	640	190	100-160			
3		C = 0,25 -0,55 tempered	850	250	90-150			
4	Machining steel	C = 0,25 -0,8 annealed	915	270	80-140			
5		C = 0,25 -0,8 tempered	1020	300	75-125			
6		annealed	610	180	90-140			
7	Low-alloy steel	tempered	930	275	60-110			
8	Cast steel	tempered	1020	300	60-110			
9	Machining steel	tempered	1190	350	60-100			
10	High-alloy steel	annealed	680	250	60-110			
11	Cast steel	annealed	680	250	60-110			
11	High-alloy tool steel	hardened and tempered	1100	325	50-60			
12-13	Stainless steel and cast steel	ferritic/martensitic annealed	680	200	50-90			
14.1	Stainless steel	austenitisch quenched	610	180	40-80	G16		
14.2		austenitic/ferritisch (duplex)	880	260	40-80			
15	Grey cast iron	perlitic/ferritic		180	110-160	K10/G12		
16		perlitic (martensitic)		260	100-150			
17	Cast iron with nodular cast iron	ferritic		160	80-130			
18		perlitic		250	70-120			
19	Malleable	ferritisch		130	90-150			
20		perlitic		230	80-140			
21	Aluminium forging alloys	not heat treatable aushärtbar/ausgehärtet		60	-1000	K10/PKD		
22				100	-800			
23	Aluminium casting alloys	<12% Si not heat treatable		75	-1000			
24		<12% Si heat treatable/heat treated		90	-800			
25		>12% Si not heat treatable		130	-600			
26	Copper	Machined alloys, Pb >1%		110	70-120	K10/G12		
27	Copper alloys	CuZn, CuSnZn		90	70-120			
28	(bronze, brass)	Cu, lead free Copper/electrolyte copper		100	70-120			
29	Non metallic materials	Duroplastic			-200	K10/PKD		
30		Reinforced materials			-200			
31	Heat treatable alloys	Fe-based annealed		200	30-50	G16		
32		heat treated		230	30-50			
33		Ni- or Co-based annealed		250	20-40			
34		heat treated		350	20-40			
35		cast		320	20-40			
36	Titanium alloys	Pure titanium	400		20-40	K10		
37		Alpha-beta alloys	1050		20-40			

Assembly Instructions



Changing the insert

Disassembly

- Loosen clamp set (1 to 2 turns) and remove worn insert
- Clean pocket seat

Assembly

- Put new insert into pocket seat
- Press insert into the pocket seat while slightly tightening the clamp set
- Push insert against the drill, therefore place 0.03 mm feeler gauge between insert and drill
- Hold insert in position and tight down clamp set with recommended torque

Clamp set (Series 20067)	Clamping set for	Torx Screw Size	Torque (Ncm)
E4890, order code 2.000	H 2006-... ..	6	70
E4991, order code 2.500	H 3006-... ..	8	140

Torque wrenches

Series 20063	Version	Torx Screw Size	Ncm
E5000, order code 1.200	adjustable	6	20-120
E5001, order code 6.000	adjustable	8	100-600
E54006, order code 0.700	fixed	6	70
E54008, order code 1.400	fixed	8	140

Recommended drills and hydraulic chucks

All drill / chamfering adapters are especially designed for the hydraulic chuck line of the GUHRING GM 300 program and the solid carbide drill line RT 100 (DIN 6537 L/K) .

DID YOU KNOW GUHRING HAS TOOL HOLDERS?

Guhring offers a complete line of
tool holders and clamping systems.

FEATURING:

TSG 3000

Thermo Secure Gold 3000
High-End Shrink Fit Chuck

Up until now one couldn't tell a chuck's temperature. With the optical
temperature indicator on Guhring Thermo Secure Gold 3000 chucks,
this source of danger is a thing of the past.

A red ring signals:

Attention, hot! Risk of burning!

The chuck has a temperature above 113° F.

When the temperature drops below 113° F, the ring turns blue.

The chuck can now be held without danger.

With a shrink fitted tool optimal clamping is now achieved.





Complete Program

Tapping, fluteless tapping
and thread milling



GUHRING



THREADING TOOLS

Very special

Specialists for micro and
hard machining

Visit www.GUHRING.com
for more information

GUHRING

Strong Performance

Milling cutters for maximum performance and quality

RF 100

High-performance end mills
with variable helix



GUHRING



MILLING CUTTERS

CR 100

Milling cutters for
composite materials



Visit www.GUHRING.com
for more information

GUHRING

HSC face milling cutters



PCD milling cutters





PCD/CBN TOOLS



Visit www.guhring.com
for more information

Venture a step into the future with Guhring and multiply your production output!

Our intelligent tooling solutions for the machining of cylinder heads reduce the number of tools and subsequently keep the manufacturing steps in your production to a minimum. Increase your production output while simultaneously reducing your costs:

- > **less tools**
- > **reduced tool changes**
- > **shorter manufacturing cycles**
- > **reduced machining time**
- > **increased productivity**
- > **improved economic efficiency**

Don't stay with the current technology available. Gain the advantage with our future solution!



PCD finishing drill

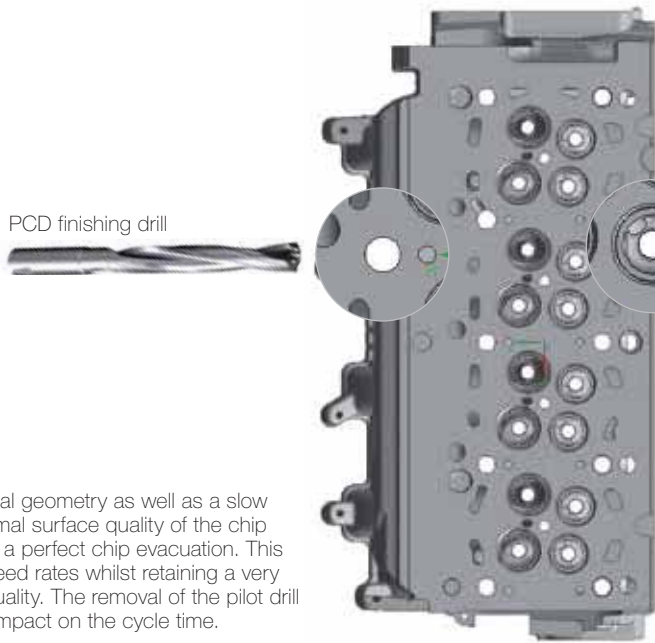

Inlet or exhaust port + valve seat:

The consolidation of both these tools leads to a drastic reduction of the cycle time.



Bolt holes:

Thanks to a special geometry as well as a slow helix and the optimal surface quality of the chip chamber ensures a perfect chip evacuation. This allows very high feed rates whilst retaining a very high machining quality. The removal of the pilot drill has a significant impact on the cycle time.

Finish machining valve seat and guide:

Thanks to the extremely robust design the previously required pilot tool can be omitted.

FUTURE SOLUTION

HLA drill-reamer



Hydraulic lash adjuster:

Saving the pre-machining reduces the cycle time enormously.

Injector bore:

Optimal partitioning of the chip chambers ensures a flawless chip evacuation.

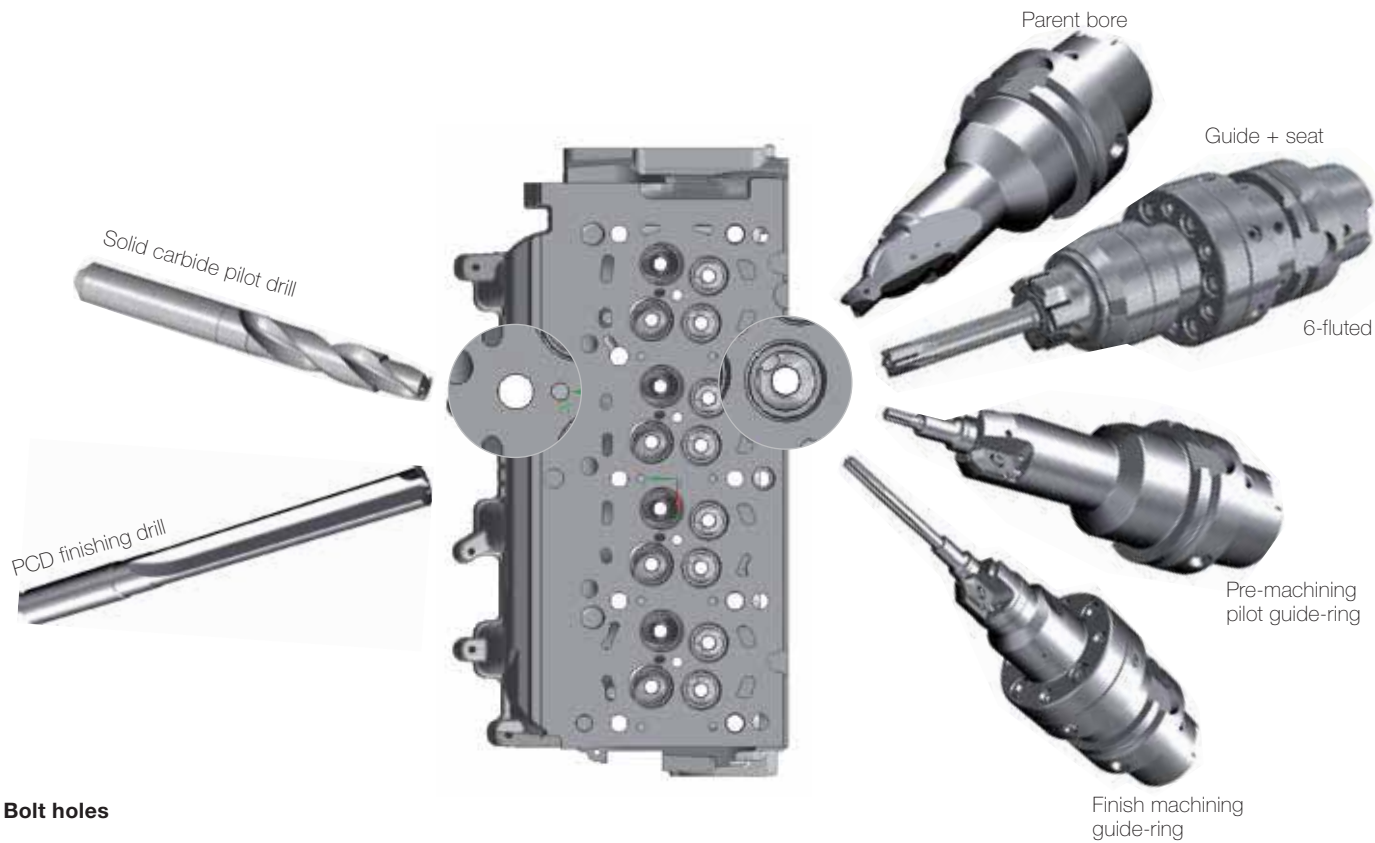

OPTIMIZATION



Injector bore

Parent bore

Guide + seat

3-fluted

Pre-machining
pilot guide-ring

Finish machining
guide-ring

Solid carbide pilot drill
Solid carbide finishing drill

Bolt holes

CURRENT TECHNOLOGY

Solid carbide pre-machining
PCD 2-fluted reamer

Hydraulic lash adjuster

Injector bore

GUHRING

Tooling know-how from a single source

The machining of turbochargers is the perfect example of a highly complex, extremely demanding machining task. Components in a variety of materials must be machined with μm accuracy so that the turbocharger can meet the extreme demands of every day use.

Guhring provides you with intelligent, powerful and highly accurate tooling solutions from one source for all turbocharger machining matters that harmonise perfectly in your production.

Your advantages:

- > **perfectly co-ordinated tooling solutions**
- > **a smooth production process**
- > **a contact person to answer all your machining questions**



PR 1000 M reamers:

Smallest diameters with a high number of flutes

- from \varnothing 2.0 mm with 4 flutes
- from \varnothing 3.0 mm with 6 flutes

Maximum performance for super-fine finishing of very small blind hole and through hole diameters!

COLD SIDE

Compressor wheel

Material: AISi

Shaft bore



Solid carbide pilot drill

N = 8000 1/min
f = 0,17 mm/rev.



Solid carbide pre-drill

N = 8000 1/min
f = 0,17 mm/rev.



PR 1000 M

N = 5000 1/min
f = 0,25 mm/rev.

Blade milling



Solid carbide radius milling cutter

N = 24000 1/min
f = 0,14 mm/rev.



Countersink/chamfer tool

N = 6000 1/min
f = 0,10 mm/rev.

Compressor housing

Material: AISi

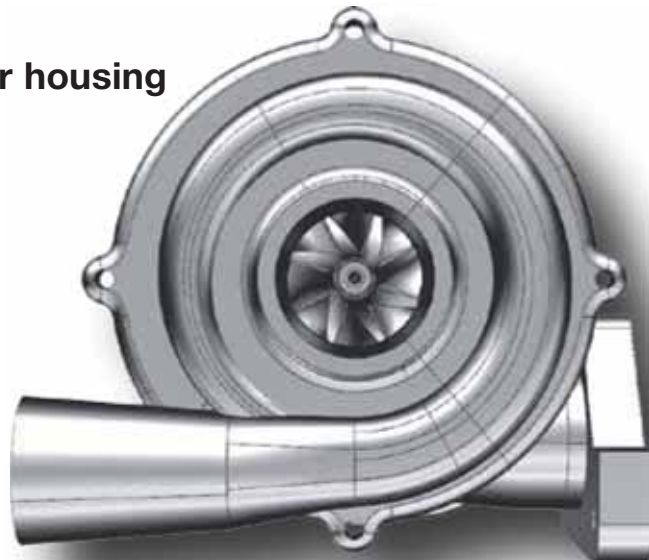

Tap M10

N = 1200 1/min
P = 1,5



PCD overturning tool

N = 10000 1/min
f = 0,4 mm/rev.



Adjustable PCD reamer

N = 8000 1/min
f = 0,6 mm/rev.

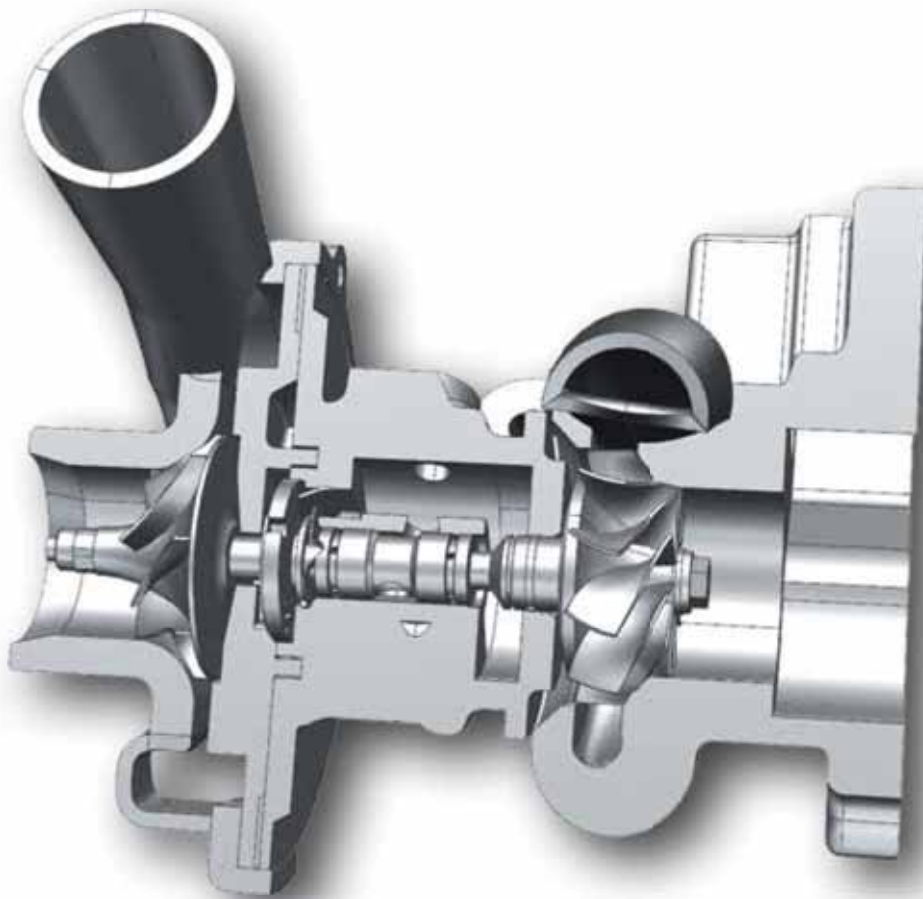

BEARING HOUSING

Material: GG

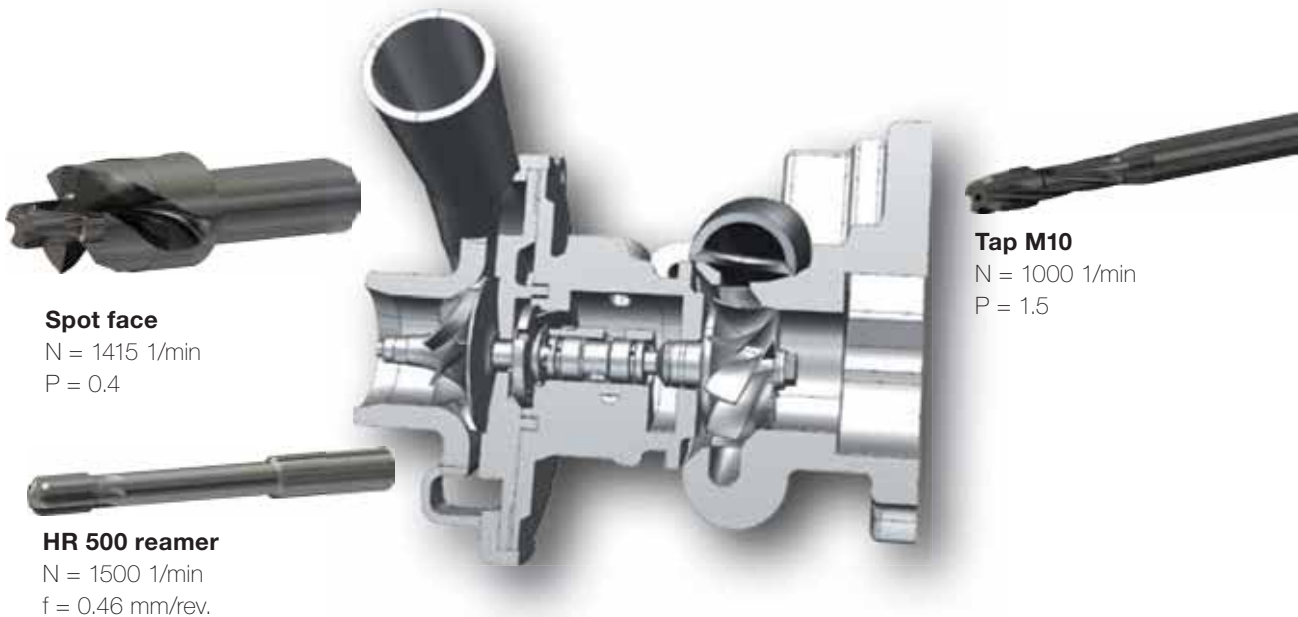

Gühring provides optimal technical and economic solutions for the machining of all sub-assemblies. Complete machining concepts are not regarded as suitable due to the diversity of turbochargers and manufacturing processes. The policy is **individual customer solutions.**

Turbine housing

Material: GGG



Solid carbide step drill

N = 1270 1/min
f = 0.3 mm/rev.



Solid carbide contour cutter

N = 2785 1/min
f = 0.53 mm/rev.



Solid carbide combi cutter

N = 2785 1/min
f = 0.36 mm/rev.

Hollfelder-Guhring machining concept

out of standard components



Turbine wheel

Material: Inconel



HSS centre drill

N = 3500 1/min
f = 0.015 mm/rev.

Eccentric bolt adjustment

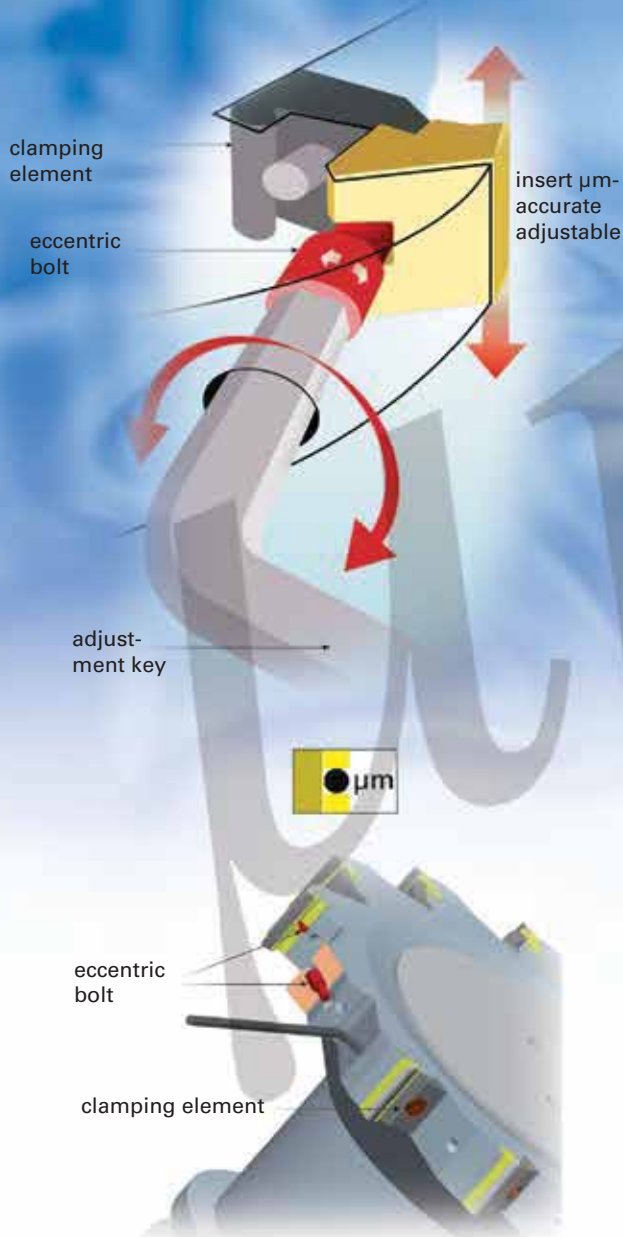

Adjustment with tapered screw

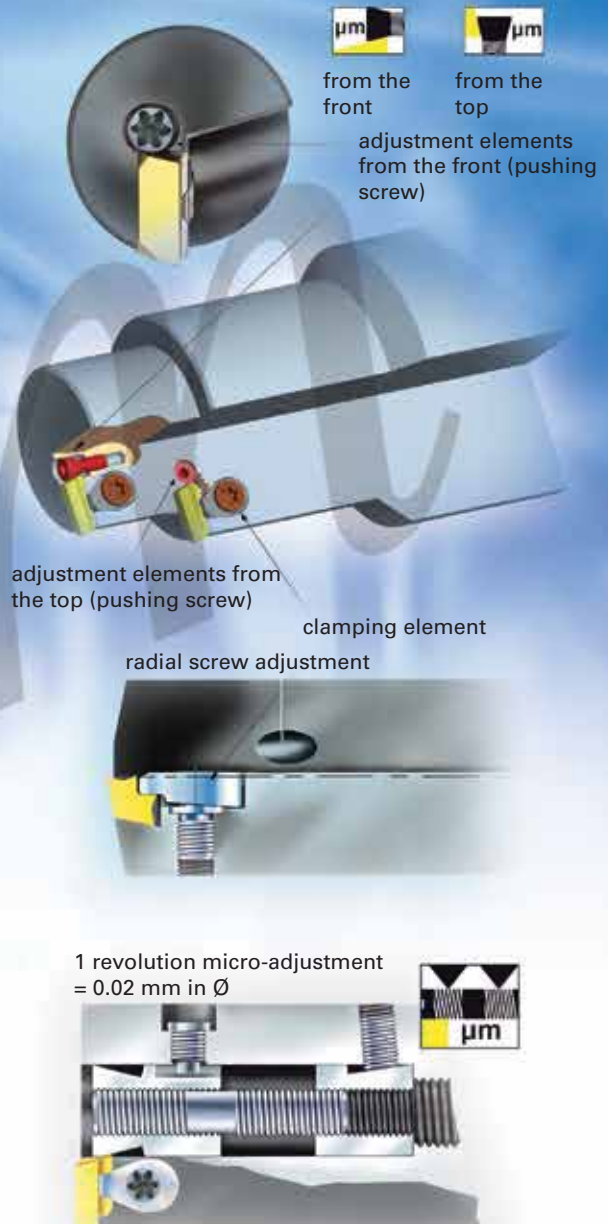

ADJUSTMENT SYSTEMS

Hollfelder-Guhring Cutting Tools is your experienced partner for μm -accurate adjustable tooling for standard as well as for specific applications. The adjustment systems are the basis for innovative tooling solutions and guarantee a highly accurate process, an enormous increase in productivity as well as considerable cost savings.

TM VENDING MACHINE

Guhring's modular TM Vending Machine relieves the customer of all tasks regarding tool storage and administration. Drawer and spiral modules enable the individual adaptation to specific customer storage requirements. The intelligent software ensures tool availability around the clock and detailed evaluation of all consumption and movement data.



Visit www.guhring.com
for more information

Perfect Team

Guhring shrink fit systems
and chucks



Extremely quick
Extremely accurate
Extremely small



GE 100

The multi-functional
tooling system



TOOL CLAMPING DEVICES

HMC 3000

Hydraulic chucks for shanks < \varnothing 6mm

Visit www.guhring.com
for more information

GUHRING

Technical information and advantages



Fig. 1:
HSK-A 63 interface,
automatic tool change

Toolholders

Our modular tooling system GM 300 has been developed for the application of rotating and stationary tools. 1987 we developed the GM 300 coupling. Standardization for this interface (DIN 69893) was obtained in 1991. Since 12/2001 the HSK interface is also standard to ISO 12164-1/-2. The unique design of the clamping method offers not only an ideal interface for manual clamping within the tooling system, but also an ideal interface for automatic clamping directly to the machine spindle (fig. 1) or tool holder.

Characteristic feature:

Tapered hollow shank (HSK) with axial plane clamping mechanism according to DIN 69893. The most important advantages are as follows:

- High static and dynamic rigidity

The radial and axial forces generated in the tool shank provide the clamping force necessary for extreme rigidity (fig. 2). Recommended values for the GM-300 module for manual clamping (see page 21 + 23 + 35).

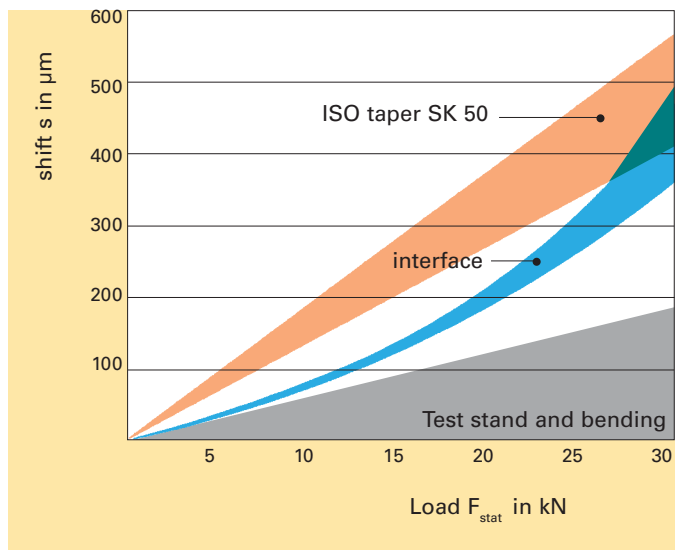
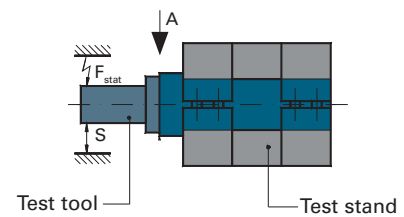

Fig. 2
Static deflection: Comparison between ISO taper 50
and automatic interface HSK-A 100 (A)

ISO taper DIN 2080 DIN 69871	HSK form A/C/(E) DIN 69893 part 1	HSK form B/D/(F) DIN 69893 part 2
-	HSK 40	HSK 50
SK30	HSK 50	HSK 63
SK40	HSK 63	HSK 80
SK45	HSK 80	HSK 100
SK50	HSK 100	HSK 125

Association between ISO taper - hollow taper shank

Technical information and advantages

- **High torque transmission and defined radial positioning**

The wedging effect between the hollow taper shank and the holder or spindle causes a friction contact over the full taper surface and the plane supporting face (fig. 3). Two keys engage with the shank end of the tool holder and provide form-closed, radial positioning, thereby excluding any possible setting errors.

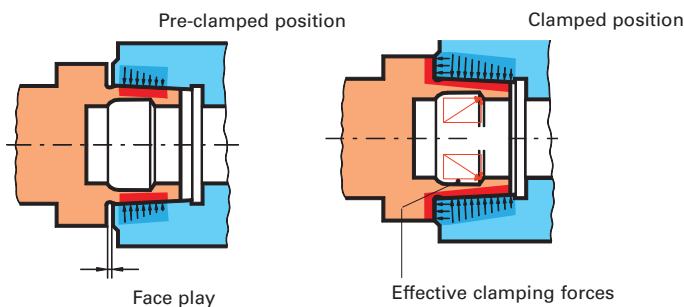
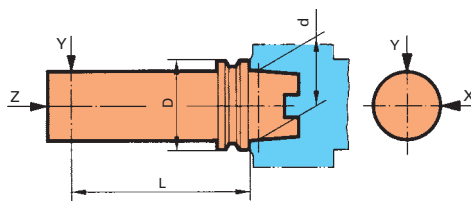

Fig. 3 Prestressing and frictional forces of hollow taper shank at the interface.

- **High tool change accuracy and repeatability**

The circular form engagement of the clamping claws within the hollow tool shank provides a totally tight connection between the shank and spindle or holder respectively (fig. 3 and 4).



HSK-size D	d mm	L mm	X mm	Y mm	Z mm
32	24	50	0,002	0,002	0,002
40	30	60	0,002	0,002	0,002
50	38	75	0,002	0,002	0,002
63	48	100	0,002	0,002	0,002
100	75	150	0,002	0,002	0,002

Fig. 4 Radial and axial repeatability of interface for manual and automatic clamping

- **High speed machining performance**

The higher the number of revolutions the better, as this increases both the power and effectiveness of the locking of the clamping mechanism. The direct initial stress between the hollow taper shank and the spindle holder compensates for the spindle expansion generated by the centrifugal force so that there is absolutely no radial play (fig. 3). The plane clamping position prevents any slipping in the axial direction.

- **Short tool changing time**

Efficient tool change due to a short shank length (approx. $\frac{1}{3}$ of the conventional ISO taper) and light weight (approx. 50% of the ISO taper).

- **Simple, cost-efficient shank design**

No moving components at the tool shank means no wearing parts.

- **Insensitive to foreign matter**

The uninterrupted design of the ring-shaped axial plane clamping simplifies the cleaning of the coupling. During automatic tool change compressed air provides ideal cleaning in the interface.

- **Coding and identification**

To allow for the attachment of common identification systems, a hole of 10 mm dia. and 4.5 mm depth is provided for the data media (coding chips) in the vicinity of the collar.

- **Standardizing of interface**

GM 300 corresponds to ISO 12164-1/DIN 69893 (fig. 5).

- **Coolant feed**

The tools for automatic clamping, HSK-A and E, are designed for a central coolant feed by means of a duct. Tools with manual change behind the GM 300 interface also operate with a central coolant feed. The clamping elements are entirely sealed against the entry of coolant so that fouling is prevented.

- **Installation of the coolant supply set**

Coolant supply sets are to be ordered separately for all GM 300 modules. The installation of the coolant duct must be carried out by the user as shown on page 141.

MQL 4-Point Clamping



Guhring no. Description

4930	MQL 4-point clamping sets
4931	Clamping device for MQL 4-point clamping sets
4932	Ejector for MQL 4-point clamping sets
4933	Retention spindles for MQL 4-point clamping sets
4934	Adaptor for MQL 4-point clamping sets
4935	Retention screw for MQL 4-point clamping sets

4-Point Clamping



Guhring no. Description

4351	HSK-C extensions
4355	HSK-A/HSK-C reducing adaptors
4385	Short HSK spindle adaptor
4386	HSK spindle adaptor (in front)
4387	ISO taper/HSK-C basic adaptor on spindles to DIN 2079
4953	Brass sealing collars
4957	Components for 4-point clamping sets
4958	4-point clamping sets for conventional cooling
4959	Components for 4-point clamping sets
4961	Ball pressure screws
4963	Torque sockets

PowerClamp



Guhring no. Description

4509	ISO taper basic adaptors DIN 2080 form A/HSK-C
4510	VDI basic adaptors DIN 69880-1/HSK-C
4512	ISO taper basic adaptors DIN 69871 form AD/HSK-C
4514	MAS 403 BT/HSK-C basic adaptors
4549	HSK-A/HSK-C extensions
4551	Spring and threaded pin for PowerClamp set
4553	Aluminium locking rings
4554	PowerClamp sets
4555	Threaded spindle for PowerClamp set
4557	Tensioning nut set for PowerClamp set
4581	HSK adaptors (in front)
4582	HSK adaptors (in front) for turning centers
4584	HSK-C spindle adapters (integrated)
4586	HSK adaptors (in front)
4953	Brass sealing collars
4961	Ball pressure screws

MQL Program



Guhring no. Description

4209	HSK-A MQL-Hydraulic-chucks
4210	HSK-A MQL-Hydraulic-chucks
4310	Collets for MQL
4330	MQL synchro tapping chuck
4350	HSK-A extensions with minimal lubrication
4735	MQL HSK-A shrink fit chucks
4741	MQL HSK-A shrink fit chucks
4919	MQL length pre-setting screws
4924	MQL coolant delivery sets
4939	MQL coolant delivery set HSK-A
4940	MQL filler HSK-A
4941	Length adjustment screw
4948	Mounting adapter
4972	Mounting adapter

Hydraulic Chucks



Guhring no. Description

4038	Clamping force measuring instrument Senso 3000
4099	Extraction key for reduction bushes
4213	ISO taper hydraulic chucks DIN 69871 with increased clamping force
4221	MAS/BT hydraulic chucks with increased clamping force
4267	HSK-C hydraulic chucks with increased clamping force
4295	HSK-C hydraulic chucks
4296	HSK-A hydraulic chucks with radial length pre-setting
4299	HSK-A hydraulic chucks with increased clamping force
4313	ISO taper hydraulic chucks DIN 69871
4315	Length pre-setting ISO taper adaptors
4316	Universal length pre-setting HSK adaptors
4319	Universal length pre-setting ISO taper adaptors
4321	MAS/BT hydraulic chucks
4367	HSK-C hydraulic chucks
4368	Reduction bushes for hydraulic chucks w/o peripheral cooling
4369	Reduction bushes für hydraulic chucks with peripheral cooling
4395	HSK-C hydraulic chucks with radial length pre-setting
4396	HSK-A hydraulic chucks with radial length pre-setting
4399	HSK-A hydraulic chucks
4900	Adjustment screws
4919	MQL length pre-setting screws
4992	Taper inserts
4993	Plug inserts

Shrink Fit Technology



Guhring no. Description

4718	Length pre-setting adaptor
4719	Shrink fit extensions
4720	Centering ring
4721	HSV 2000 hot air shrink fit system
4729	GUhroJet ISO taper shrink fit chucks DIN 69871 Form AD/B
4736	HSK-A shrink fit chucks
4737	HSK-E shrink fit chucks
4738	ISO taper shrink fit chucks DIN 69871 form AD/B
4739	MAS-BT shrink fit chucks
4742	GISS 2000 induction shrink fit system comfort version
4743	Induction spindle
4744	ISO taper holders
4745	HSK holders
4747	SpeedCooler
4748	Trolley
4749	Tongs
4750	Protective gloves
4751	GISS 2000 ECO
4752	GISS 2000 ECO Plus
4753	GISS 3000 induction shrink fit system
4755	Guhrojet HSK-A shrink fit system with peripheral cooling
4758	HSK-C shrink fit chucks
4759	SpeedCooler Manager
4769	Limit stop washers
4773	Cooling adaptor
4774	HSK-A/E accessory sets
4775	HSK-C accessory sets
4776	ISO taper accessory sets
4777	MAS BT accessory sets
4919	MQL length pre-setting screws
4977	Shrink fit chuck length setting screw

Tool Holders



Guhring no. Description

4206	Inserts for quick-change tapping chucks
4300	HSK-A precision clamping chucks
4301	SK-A precision clamping chucks
4302	Clamping sleeves for precision clamping chucks
4303	HSK-C collet holders
4304	HSK-A collet holders
4306	Retaining nuts, system DIN ISO 15488
4307	Collets to DIN ISO 15488
4308	Tapping collets
4317	ISO taper side lock holders
4318	ISO taper collet holders DIN 69871 form AD/B
4320	HSK-A Morse taper holders
4322	ISO taper side lock holders
4323	HSK-C collet holders, sealed version
4324	HSK-A collet holders, sealed version
4326	Synchro tapping chucks, straight shank
4327	Synchro tapping chucks, HSK-A
4328	Quick-change tapping chucks, HSK-A with IC
4329	HSK-A side lock holders
4333	HSK-C side lock holders
4334	HSK-A side lock holders
4335	Sealing washers
4340	Quick-change tapping chucks w/o IC
4342	Quick-change tapping chucks with IC
4343	HSK-A adaptors for tapping chucks
4346	HSK-A NC drilling chucks with IC
4361	HSK-A shell milling arbors
4362	Milling arbor HSK-A
4397	HSK-E collet holders
4901	Adjustment screws for HSK-C collet holders
4902	Adjustment screws for HSK-A/HSK-E collet holders
4906	Adjustment screws for tapping collets
4907	Screws DIN EN ISO 4762
4913	Chuck spanners
4982/4983	HSK-A/HSK-C blanks

**Measuring and Inspection Instruments
General Accessories**



Guhring no. Description

4038	Senso 3000 clamping force measuring instrument
4068	Flow rate measuring instrument PQ 3000
4076	Coolant supply measuring instrument CC 3000
4077	High-grade steel filters
4910/4911	Socket spanners
4912	Hexagon chuck keys
4914	HSK cleaning mandrels
4915	Torque wrenches
4916	Sockets
4918	Cylindrical cleaning mandrels
4921	Hexagon-socket offset screw key
4925	Pull studs DIN 69872, form A
4926	Pull studs DIN 69872, form B
4927/4928	Pull studs
4946	Tool setting fixture
4947	HSK cleaning cap
4949	Coolant delivery sets for conventional cooling
4968	Gauges for HSK tool shanks
4969	Gauges for HSK spindles
4970	ISO taper proofing bars
4971	HSK proofing bars
4973	ISO taper clamping force measuring instrument
4974	HSK clamping force measuring instrument
4975	Balancing masters for HSK spindles
4976	Centrifugal rings for short spindles to DIN 69002-3
4978	Gauges for HSK cams
4985	HSK-C sealing plugs
4990	Tool setting fixtures
4991	Interchangeable discs

Automatic tool clamping

Spindle clamping systems with draw bar

Application in machining centers, milling and turning machines

Suppliers:
Ott
RÖHM (Lic. Gühring)
BERG (Lic. Gühring)

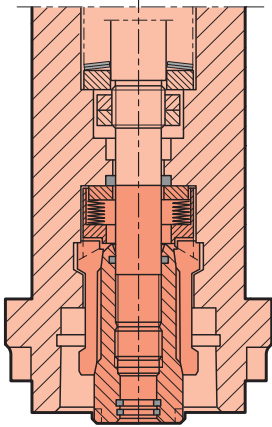

Supplier:
Ortlieb (Lic. Gühring)

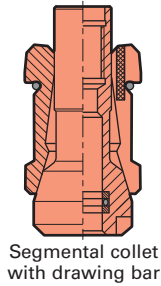
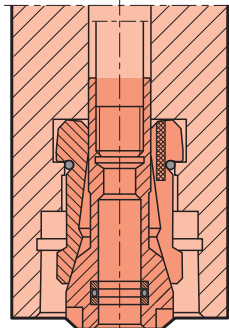

Segmental collet with drawing bar

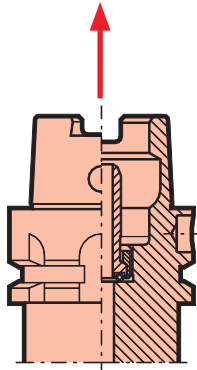

Tool shanks
DIN 69893 part 1 form A
(with coolant supply set)

Direct installation in the spindle

Application in transfer lines, fixtures, setting equipment (e.g. in drilling spindles), in multi spindle drilling heads

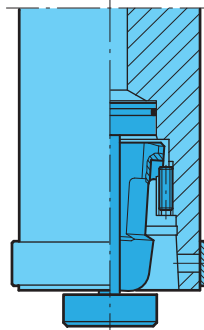

Installation in tool holders (examples)

Application in machining centers, milling and turning machines

Extensions

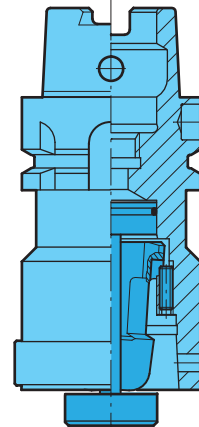

Application in existing machines using ISO taper spindles

ISO taper basic adaptors

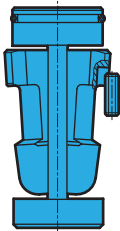
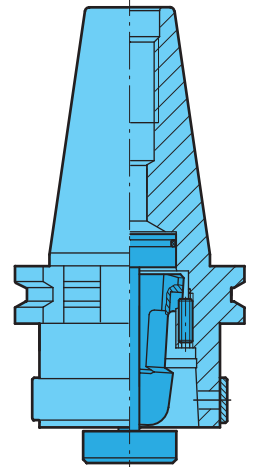

POWER-CLAMP SYSTEM

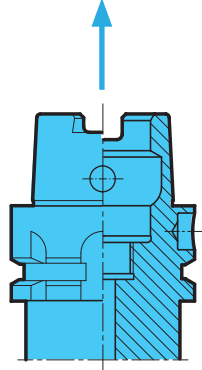

Manual tool clamping

Installation with adaptors

Application in transfer lines, fixtures, setting equipment, for universal use, e.g. milling

adaptor (integrated)

adaptor (in front)

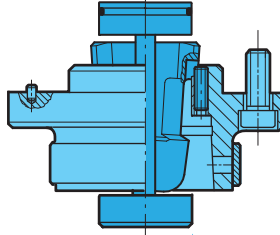
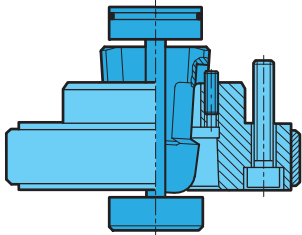
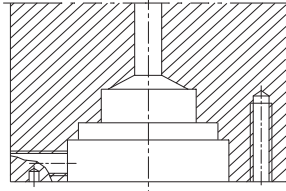
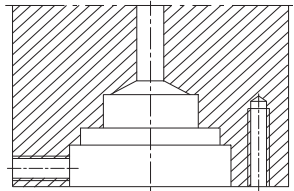

PowerClamp

Direct installation in the spindle

Application in transfer lines, fixtures, setting equipment (e.g. in drilling spindles), in multi spindle drilling heads

Installation with adaptors

Installation via adaptors

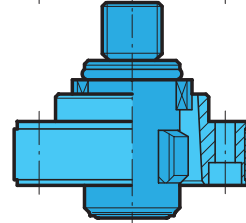
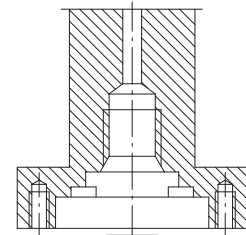
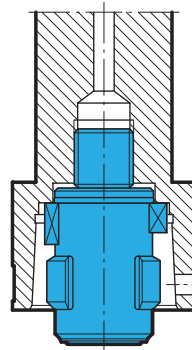

MQL clamping set

4-point clamping set

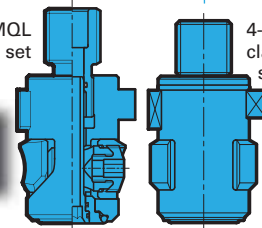

4-POINT CLAMPING SYSTEM

Tool shanks
DIN 69893 part 1 form A
(without coolant supply set)

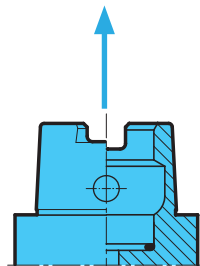

Tool shanks
DIN 69893 part 1 form C
with manual tool change

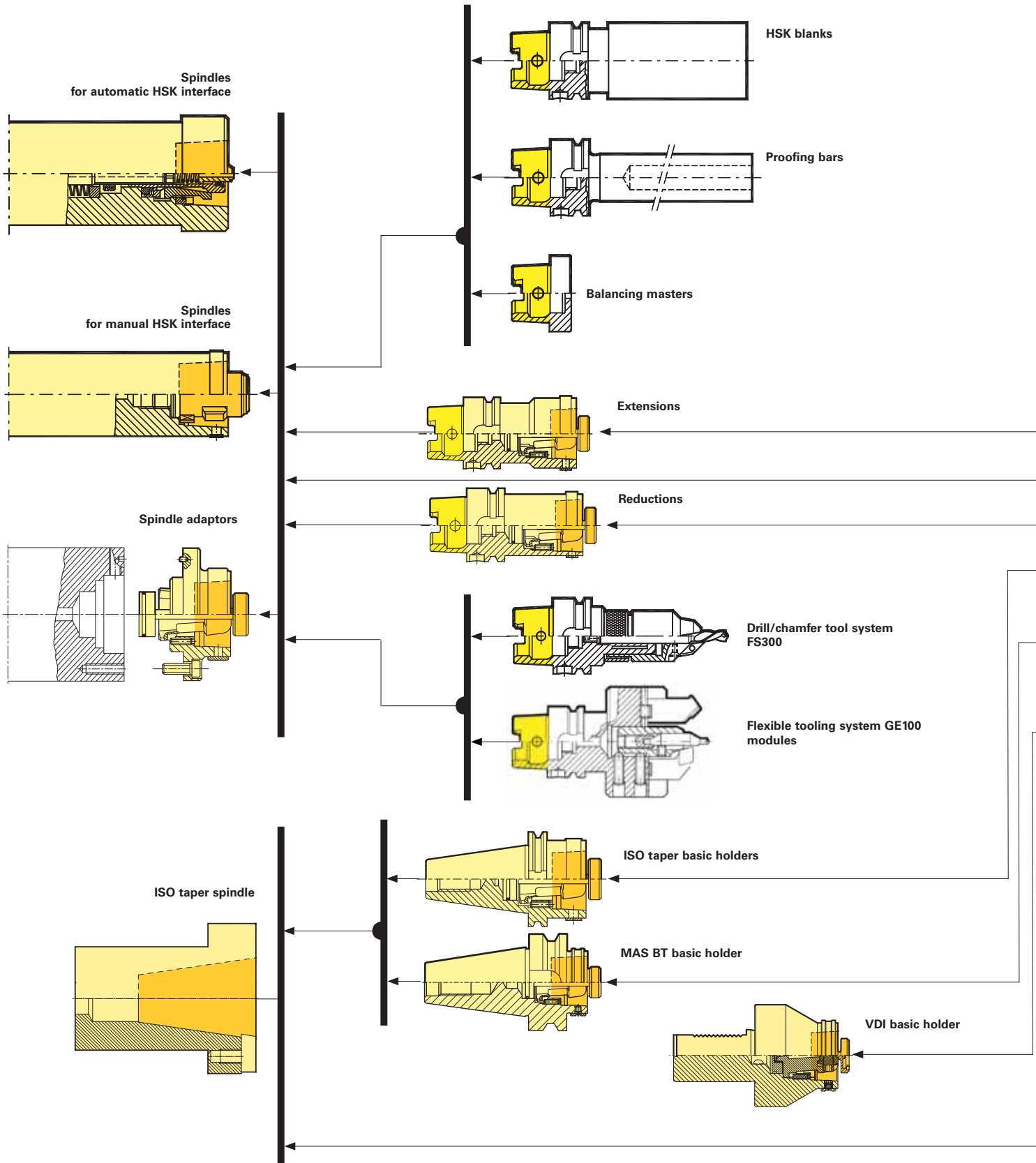

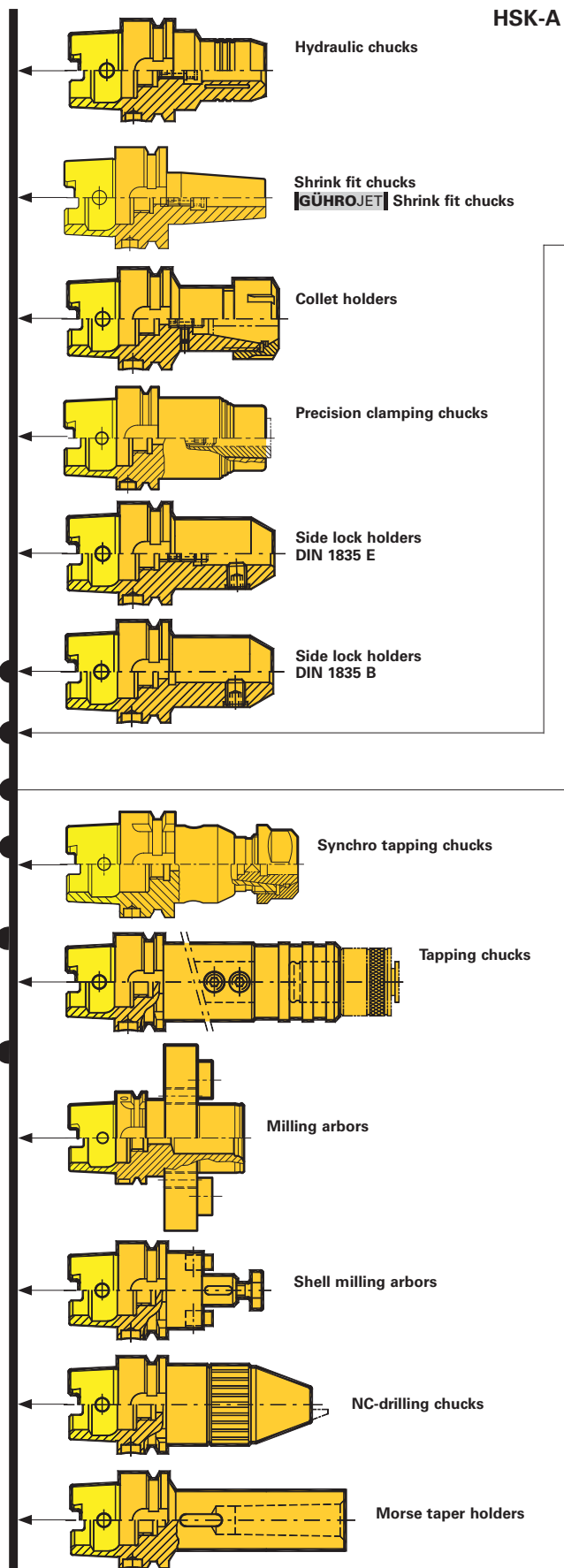

HSK-A

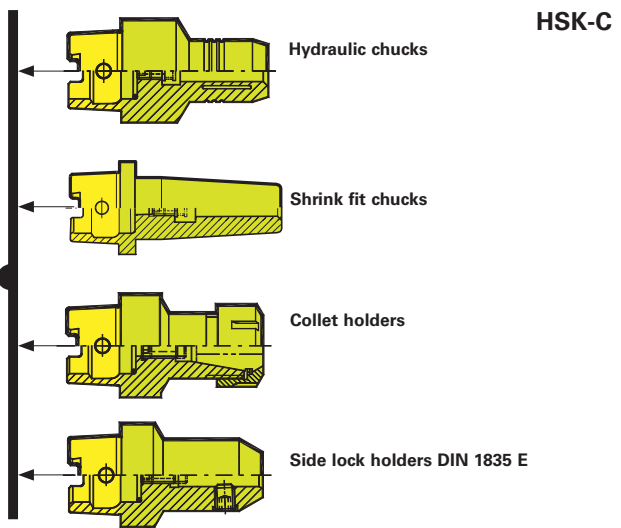

HSK-C

Tool holders
DIN 69893-5

HSK-E

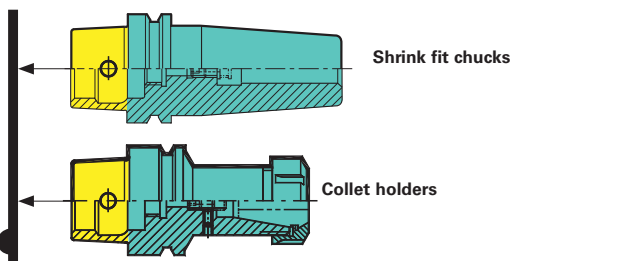

Tool holders
DIN 69871/JIS B 6339

SK/MAS BT

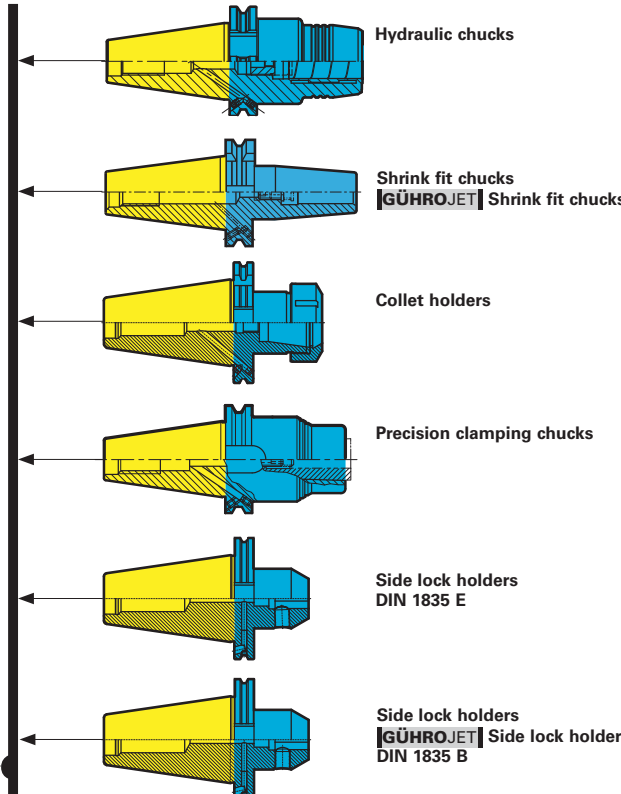

Automatic tool clamping with MQL

Spindle clamping systems with draw bar

Application in machining centres, milling and turning machines

Suppliers:
Ott
RÖHM (Lic. Guhring)
BERG (Lic. Guhring)

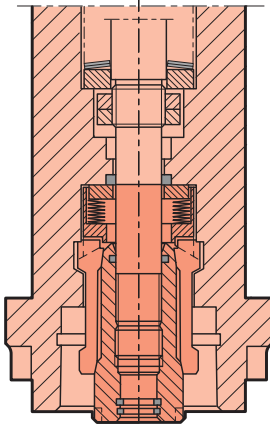

Manual tool clamping with MQL

Installation with adaptors

Application in transfer lines, fixtures, setting equipment (e.g. in drilling spindles), in multiple drilling heads

adaptor (integrated)

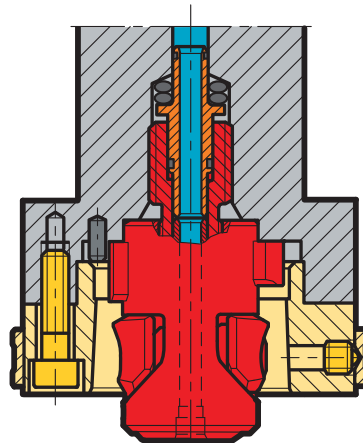

Toolholders

MQL shrink fit chuck HSK-A
Guhring no. 4741

MQL coolant delivery set
HSK-A Guhring no. 4939

MQL adjustment screw
with sealing lip for HSK-A

MQL optimised shank end

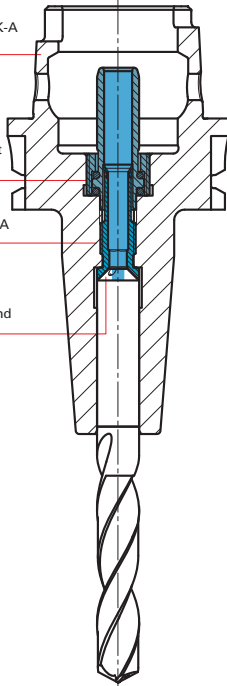

MQL shrink fit chuck HSK-A
Guhring no. 4735

MQL filler HSK-A
Guhring no. 4940

MQL adjustment screw with
sealing lip for HSK-A

MQL optimised shank end

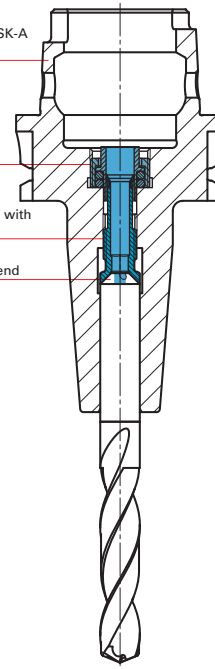

Spindle clamping systems

Tool holders
ISO 12164-1/DIN 69893-1

HSK-A

Automatic tool clamping

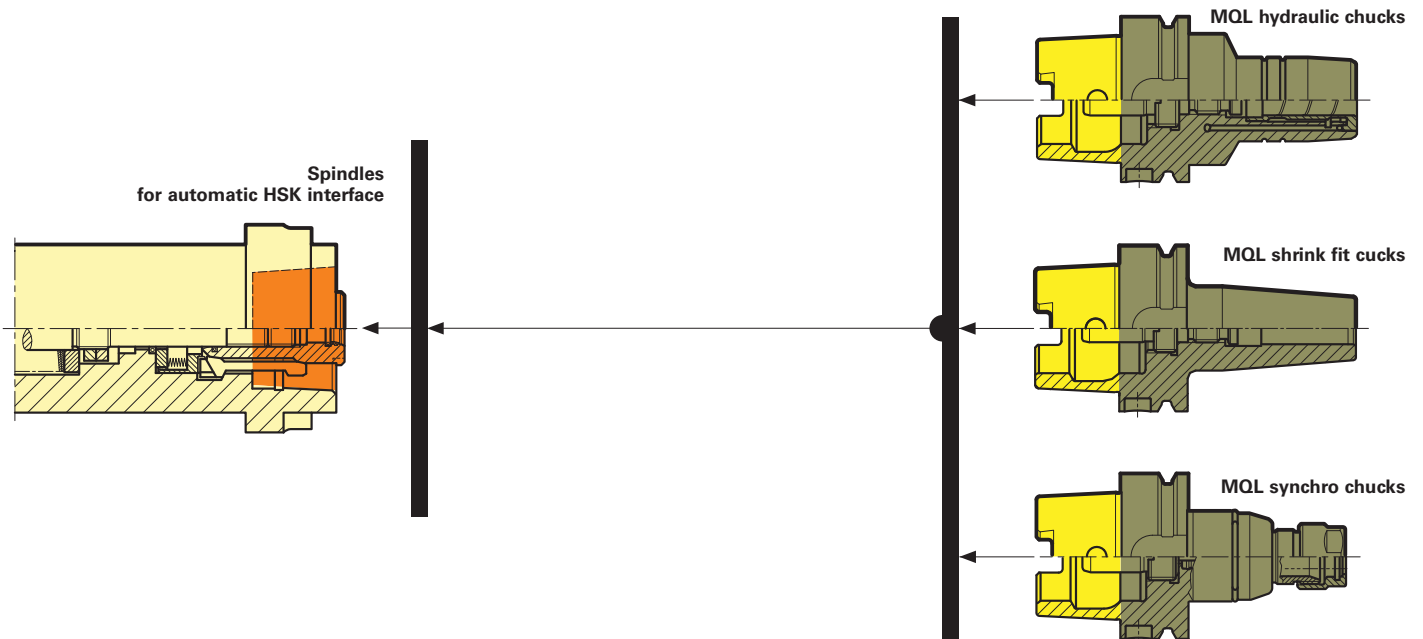

Manual tool clamping

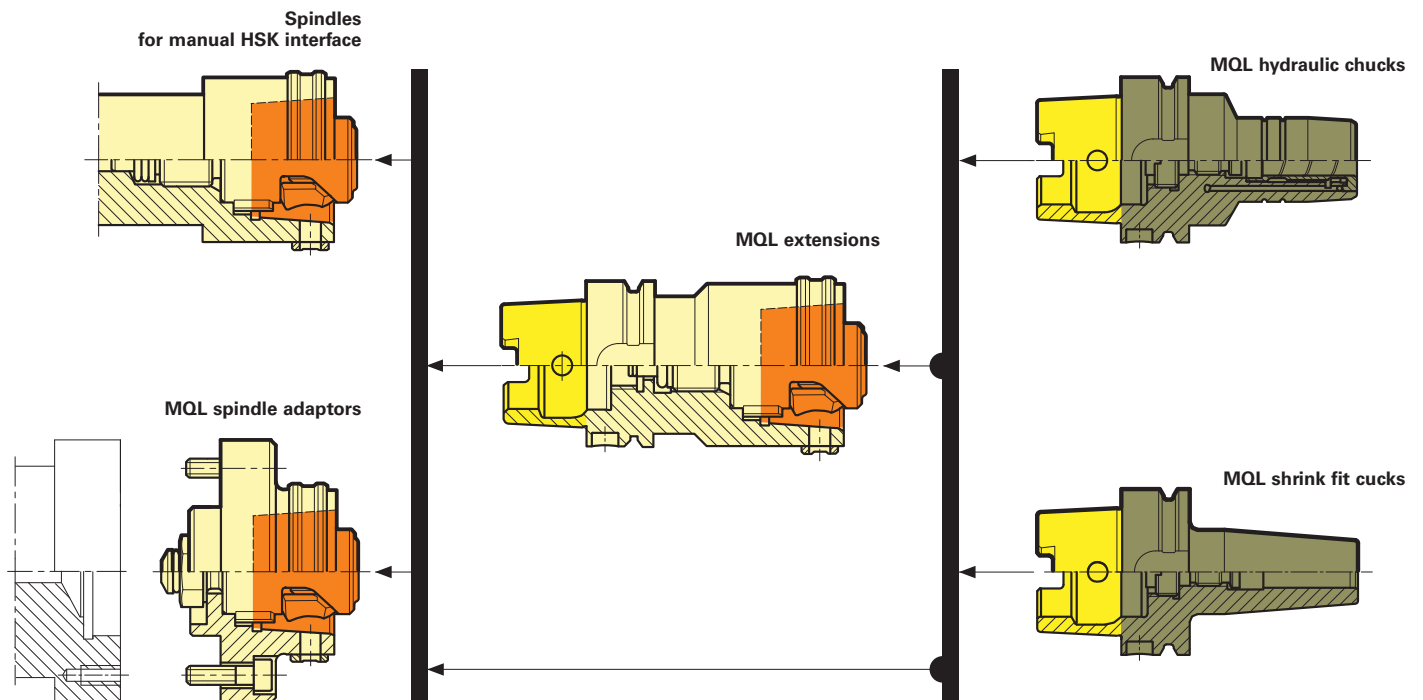

Toolholders

Technology and advantages

Guhring is heavily engaged in the subject of minimal quantity lubrication and occupies one of the top positions in this technology. In addition to the suitable MQL geometry, our priority lies especially in the optimal delivery of the coolant in the vicinity of the tool holder. Therefore, we have developed a suitable MQL shank end for our cutting tools and a suitable MQL coolant delivery system for the application with our tool holders.

Shank end suitable for MQL

Because an extremely low volume of lubricant is applied with minimal quantity lubrication, the delivery of these low coolant quantities to the effective area is of utmost importance. Hereby, the geometric design of the shank end is of main significance for a secure delivery of the lubricant.

In a comprehensive series of tests we have thoroughly investigated different geometric designs of the shank end and subsequently determined the optimal design. The Guhring developed conical shank end optimally satisfies the relevant MQL conditions:

- no lubricant pockets
- minimal dead area
- simple operation
- cost-efficient production

MQL suitable coolant delivery

The coolant delivery has also been subject to an in depth analysis. The result is the recently developed MQL delivery system consisting of a one-piece delivery pipe, with a thin-walled stainless steel pipe glued-inside and a MQL adjustment screw. The advantages of this solution are:

- simple installation
- optimal flow conditions
- the compliancy of the delivery pipe
- cost-efficiency

MQL considerably reduces the operating temperature

In comparison to entirely dry machining, MQL can considerably reduce machining temperatures. The result is longer tool life and increased process reliability. Thermo-graphic experiments at Guhring showed that cooling with dry air reduces the temperature at the tool point by more than 200 degrees. The addition of a few milliliters of neat oil per hour, hence MQL, resulted in an even lower temperature thanks to the reduced friction.

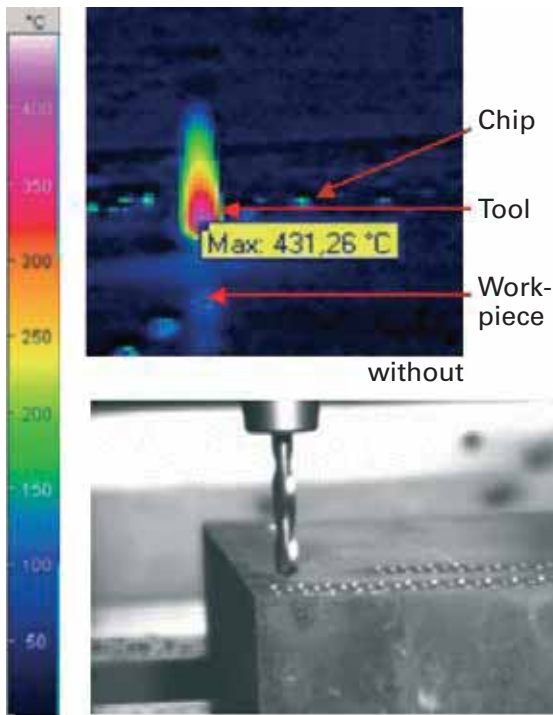

without

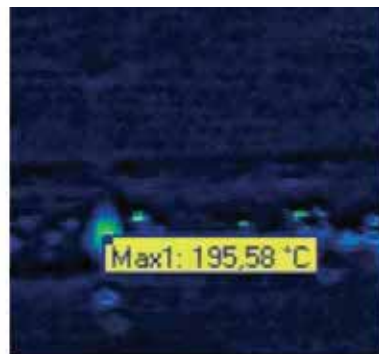

Air

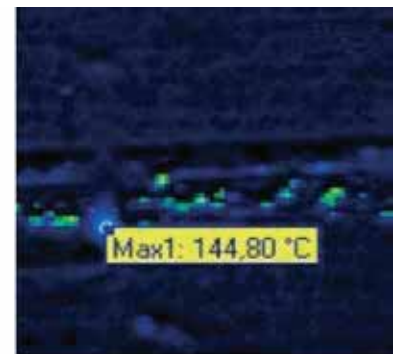

MQL

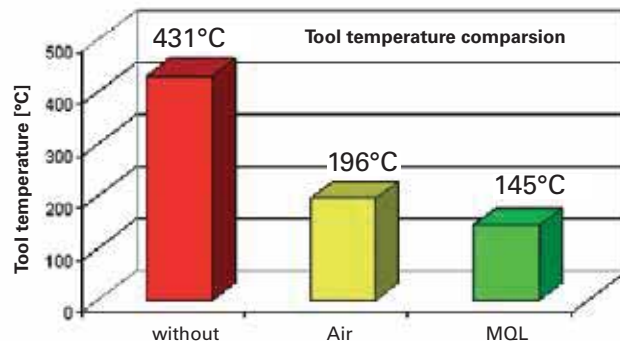

Effective cooling

Guhring has determined the heat development at the drill point when applied without cooling or with internal cooling with air or MQL respectively. With MQL, the temperature of the tool and subsequently the transfer of heat to the workpiece is considerably reduced.

Technology and advantages

Installation and application of Guhring's MQL system

For the successful application of MQL, a consistent synchronisation of tool, tool holder, coolant delivery, clamping, coolant system and machine peripherals is paramount. MQL suitable equipment is available on the market, numerous machine tool manufacturers offer machining centers that are optimized for the production under MQL conditions.

Within the scope of Guhring's tool, tool holder and clamping expertise, there are also MQL solutions available that are indicated in this catalog with a special symbol. The following diagram shows an example of a suitable MQL installation:



Guhring's MQL system
A for MQL machining optimised drill with a MQL shank end sits in a shrink fit chuck. The delivery of the MQL mixture is performed by a one-piece delivery pipe with a glued-in stainless steel pipe.

Optimal flow
An examination of the flow characteristics at the shank end shows an optimal flow for the Guhring solution without lubricant pockets or interfering turbulence. This ensures a fast and secure delivery of the oil/air mixture to the tool point.

Technology and advantages

Our 4-point clamping sets for minimum quantity lubrication MQL or conventional cooling are compatible. They are suitable for radial manual clamping. Primarily designed for installation in spindles (short drilling spindles, multiple-spindle drilling heads). Most prominent features:

- Simple and hence more economic spindle manufacture
- Short, small diameter spindles with constricted spindle bearing spacing.

Two clamping segments displaced by 180° with 2 clamping planes each are uniformly moved outwards with a differential threaded spindle, thereby generating the necessary clamping force.

Thanks to their identical fitting contour, the 4-point clamping sets for MQL - especially developed for the application with minimum quantity lubrication (MQL) and with MQL-optimized tools - offer the following special features and advantages:

- A central, coaxial minimal quantity lubrication duct with a consistent internal diameter ensures a MQL coolant delivery to the tool without coolant pockets and offers quick operating times.



① We recommend M_A max. for rough machining and milling operations. For drilling and reaming operations a lower deviation of M_A max. up to 30% is permissible. Please check the torque with a torque wrench.

② Depending on temperature and lubricating conditions these values can be up to 15% lower.

③ Due to the screwed connection, M_T max. can be lower with adaptors.

HSK-C	max. torque M_A [Nm] ①	Key size	max. drawing force [kN] ②	max. linear bending moment M_B [Nm] ②	max. transferable torsional moment M_T [Nm] ② ③
32	3	2.5	8.5	72	105
40	6	3	12.5	135	180
50	14	4	24	330	390
63	24	5	32	570	680
80	40	6	45	1000	1570
100	54	8	60	1620	4200

Installation and principle of operation

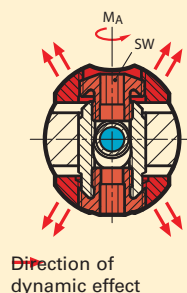

The tool is ejected automatically by the ejector being activated by the clamping jaws

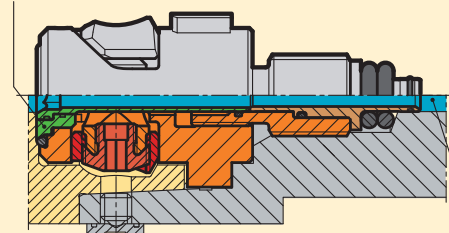

Minimum lubrication delivery

Technology and advantages

Internal contour of spindle

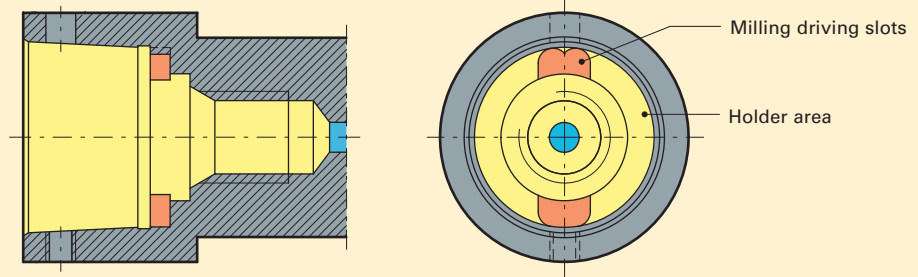

Toolholders

① We recommend M_A max. for rough machining and milling operations. For drilling and reaming operations a lower deviation of M_A max. up to 30% is permissible. Please check the torque with a torque wrench.

② Depending on temperature and lubricating conditions these values can be up to 15% lower.

③ Due to the screwed connection, M_T max. can be lower with adaptors.

HSK-C	max. torque M_A [Nm] ①	Key size	max. drawing force [kN] ②	max. linear bending moment M_B [Nm] ②	max. transferable torsional moment M_T [Nm] ② ③
25	1.5	2.5	4.5	30	30
32	3.0	2.5	7.0	60	100
40	6.0	3.0	12.0	130	170
50	14.0	4.0	20.0	280	350
63	27.0	5.0	28.0	500	640
80	54.0	6.0	40.0	900	1330

Installation and principle of operation

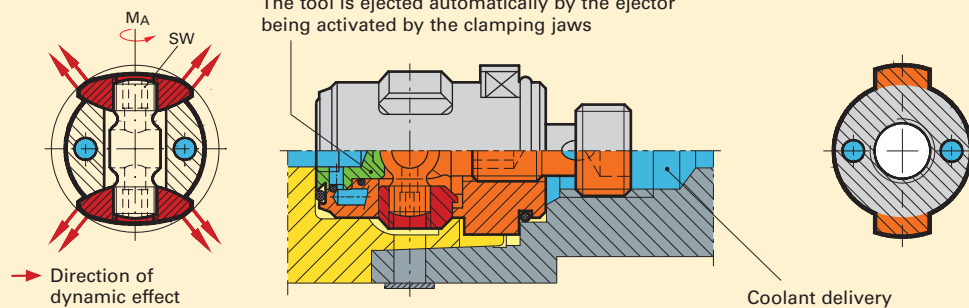

Technology and advantages

Modern machining processes place heavy demands on tool holding. Hydraulic chucks provides excellent clamping characteristics combined with precise concentricity.

Furthermore, they enable a simple and fast tool change, with the assistance of a special extraction key.

Turning the pressure screw generates sufficient pressure in the pressure chamber resulting in an elastic deformation of the clamping bush, providing powerful tool clamping and precise concentricity. A safe and powerful fit is guaranteed. If reduction bushes are applied that are able to hold varying tool diameters, the tool application may be extended without problem. If such bushes are not applied, it is essential to observe the minimum clamping length!

A summary of the advantages:

- Precise tool clamping with a maximum 3 μm deviation from concentricity
- Transmission of high torque through (excellent clamping) optimized bush clamping system
- High speed compatibility (no centrifugal forces from clamping segments)
- Precise concentricity, therefore excellent surface qualities and dimensional accuracy of the work piece
- Rapid tool change thanks to simple operation of the clamping screw
- Optimal tool life
- Hydraulic cushioning has vibration absorbing effect

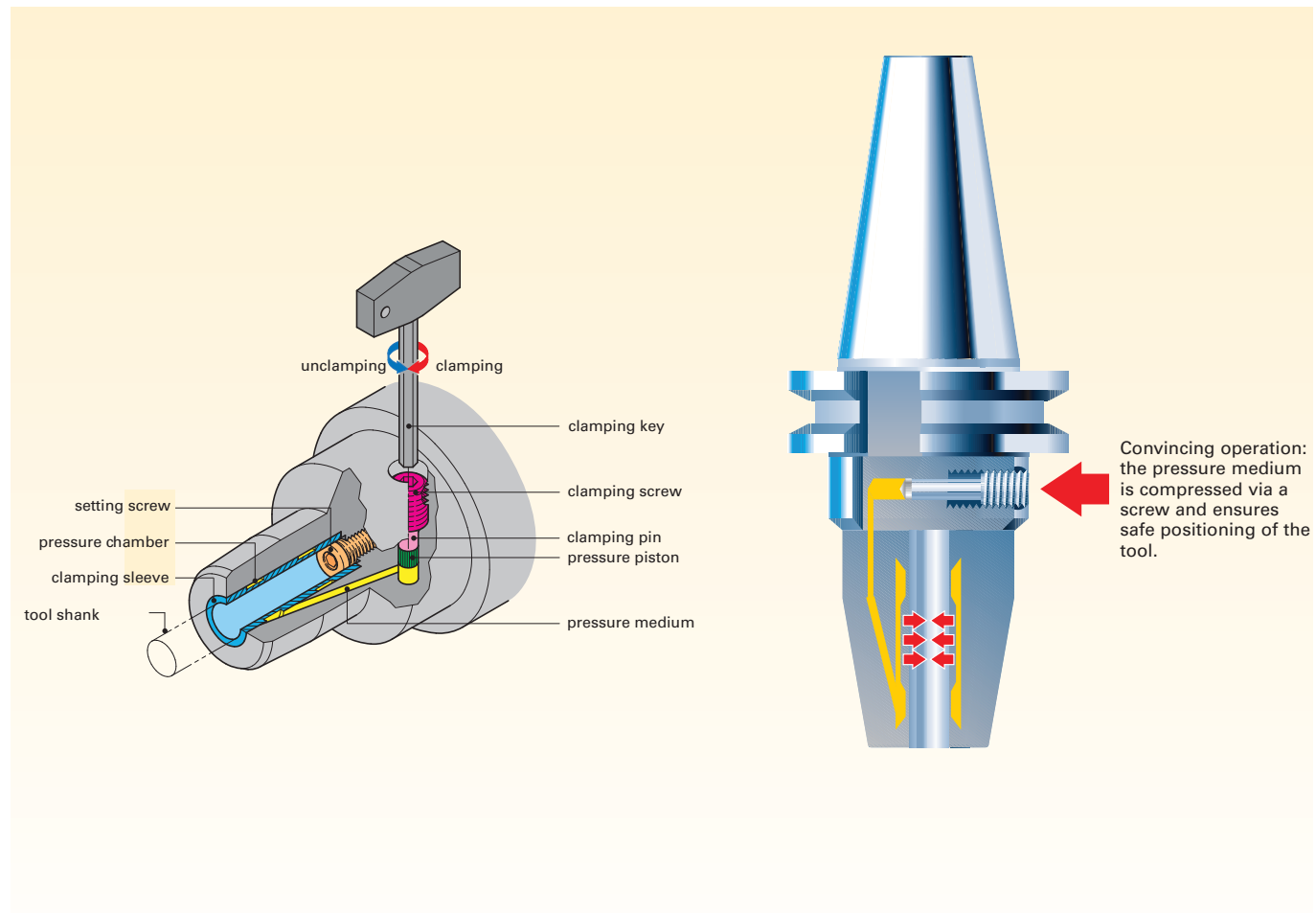

Technology and advantages

Guhring Hydraulic chucks with increased clamping force

Hydraulic chucks are suitable for clamping rotary symmetrical tools or work pieces. Straight shank tools without drive flats may be clamped up to \varnothing 32 mm, but also shanks according to DIN 6535 form HA and HB up to \varnothing 20 mm without reduction bushes. The given values in the table below are not to be exceeded. If the inserted length is less than the given minimum insertion depth or other tool shanks than specified above are applied, lower accuracy and breakage may occur!

Above all it is the high revolutions with High-Speed-Cutting operations that puts special demands on the tool holder. The clamping of the tool in a hydraulic chuck is, therefore, especially significant. Guhring has developed a hydraulic chuck that offers reliable and powerful clamping with higher torque figures, guaranteeing excellent tool clamping in the tool holder.

Combined with precise concentricity (max. 3 μ m deviation from concentricity), a very fast and simple tool change as well as the vibration cushioning effect of the pressure chamber, the new hydraulic chuck can tackle the most demanding of machining tasks. The result is optimal tool life and excellent surface qualities or dimensional accuracy of the work piece respectively.

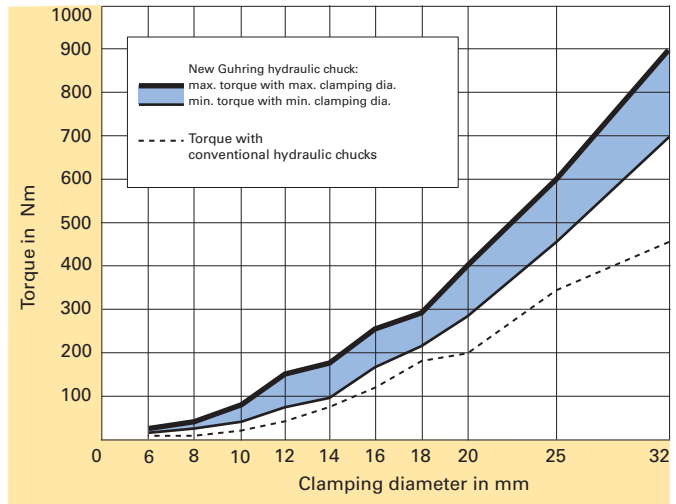

Considerably higher:
The clamping force of Guhring's new HSK-A hydraulic chuck in comparison to conventional chucks.



Technology and advantages

Guhring's shrink fit chucks ensure an optimal connection between shrink fit chuck and shank tool.

While some manufacturers use conventional case hardened steel, Guhring applies a special, application orientated tool steel. The result is an increased expansion rate as well as improved temperature adaptability. There is no limit to the number of shrink fit insertion or withdrawal operations.

Advantages:

- Short shrink fit times
- Maximum clamping force
- Shrink fit chucks available for tool shank diameters from 3 mm to 32 mm
- Longevity

These advantages are of particular interest in the field of HSC milling, difficult and rough cutting operations, drilling, reaming and internal grinding operations as well as for woodworking.

Convincing characteristics:

- Excellent concentricity
- Extreme clamping force and rigidity
- Improved tool life
- Insignificant imbalance through rotation symmetry
- Economic efficiency

Perfect team: Guhring shrink fit chucks and shrink fit systems

For the shrink fitting for withdrawal and insertion of tools in our shrink fit chucks we offer various shrink fit systems to satisfy individual customer requirements: From high-tech solutions with integrated, highly accurate length pre-setting and special shrink fit systems for extra long tools to the cost-efficient HSV 2000 hot-air shrink fit system:

- GISS 5000
- GISS 4000
- GISS 3000
- GISS 2500
- GISS 2000
- HSV 2000

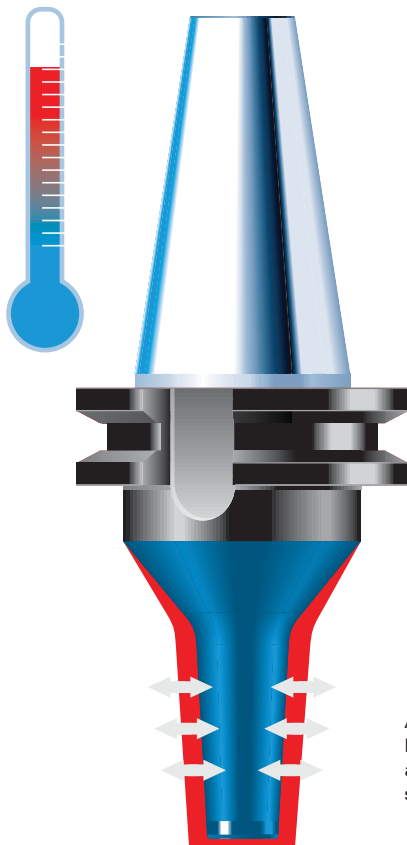

A gripping principle: Heating and cooling ensures an optimal connection between shrink fit chuck and shank tool.



A gripping principle

When shrink fitting tools in shrink fit chucks, the decisive factors for ensuring the safe clamping of the tool in the tool holder are solely the heating and cooling of the tool holder. The heating process expands the shrink fit chuck enabling a tool to be inserted or withdrawn respectively. During the cooling process it contracts again and clamps the inserted tool with maximum clamping force. Because the shrink fit chucks can become extremely hot in localised areas during the heating process and the tools shrink fitted for insertion or withdrawal respectively possess very sharp cutting edges, it is paramount that the operator wears Kevlar gloves during the shrink fit operation to prevent burns and cuts to the hands.

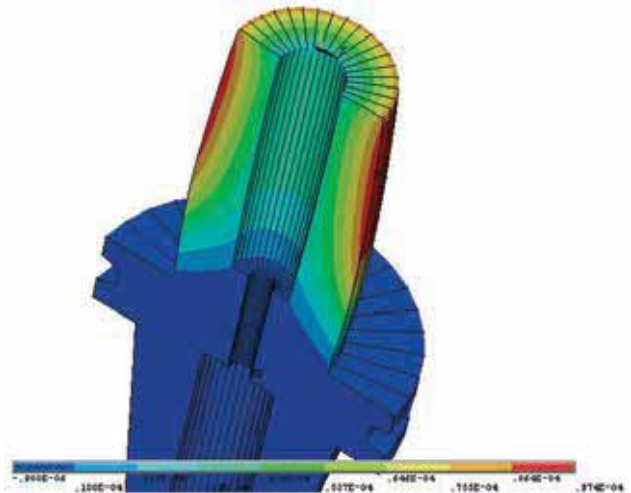

Shrink fit extensions: Increase performance

Shrink fit extensions increase the scope of a tool's performance and reduce tool surface imperfections. As with shrink fit chucks, the tool is clamped in the shrink fit extension and ideally in an hydraulic chuck. Naturally, shrink fit extensions can also be clamped in shrink fit chucks.



Technology and advantages

Pre-requisite for optimal machining is perfect tool clamping and a reliable coolant delivery. Tests with customers show that clamping and lubrication is often insufficient for the machining operation. Therefore, Guhring has developed a comprehensive range of measuring and inspection instruments enabling a quick, simple and accurate measurement or inspection on the premises of the customer. Defects can be recognized early and eliminated in order to prevent a reduction in cutting parameters and tool life or even damage to machine, clamping systems as well as tools.

Clamping force measuring instrument Senso 3000 for hydraulic chucks



The hydraulic clamping technology offers, thanks to its completely closed design, the system is impervious, requires low maintenance and guarantees longevity. Following many years of general use, however, thermal and mechanical influences can lead to a reduction in clamping force.

The new Guhring SENSO 3000 measuring instrument offers an accurate, quick and simple as well as consistent method of measuring the clamping force. An added advantage is the mobility of the system, i.e. for measuring within machines and fixtures.

SENSO 3000 determines the clamping force of the hydraulic chuck via a pressure sensitive plug gauge. The entire length of the plug gauge is clamped in the hydraulic chuck so that when tightening the clamping screw the clamping pressure of the chuck is optimally applied.

The clamping force measuring instrument displays the clamping force as an absolute measurement value on the one hand and as a percentage clamping force in relation to a reference value that can be set individually on the other.

Clamping force measuring instrument SENSO-SHRINK 3000 for shrink fit chucks



SENSO-SHRINK 3000 simply, quickly and accurately determines the clamping force of the shrink fit chuck by measuring the bore volume. The measuring result displayed by SENSO SHRINK 3000 is the deviation percentage from the nominal value of a reference chuck.

SENSO-SHRINK 3000 offers the user the following benefits:

- Simple, quick and accurate measuring of the shrink fit chuck clamping force directly on the customer's premises,
- Early recognition of wear and incorrect handling of shrink fit chucks,
- Considerable increase of process reliability during use,
- Quality assurance of overall system: tool, chuck and tool holder,
- Wireless system, providing reproducible measuring data at any time.

Flow rate measuring instrument PQ 3000 for checking the pressure and the volume of the coolant flow



Guhring has developed the PQ 3000 instrument for quick, simple and direct checking of the existing coolant pressure and rate of flow for tools with internal cooling. The check is carried out when the actual tool is clamped directly in

Technology and advantages

the stationary tool spindle, making it possible to establish the real conditions of the relevant machine and tool configuration.

PQ 3000 provides the following information:

- Pressure and volume flow of the coolant pump, the so-called P/Q characteristic curve,
- Possible pump or seal wear as well rotary transmission losses,
- Possible narrowed cross sections in the line through machine, spindle and tool holder,
- Possible blocked filters,
- possible narrowed cross sections resulting from deposits on the surface of the coolant ducts in the tool,
- the coolant duct layout in the tool.

Coolant inspection instrument CC 3000 for checking the filtering efficiency of the coolant system



With Guhring's CC 3000 you can quickly and simply check the filtering efficiency of the coolant system. In order to analyze and rectify possible weak points of the filter system, the following information is provided:

- perfect operation of the coolant filtering system,
- defective filters,
- insufficient filtering for the applied tool.

In addition, it is possible to determine the oil concentration of the applied soluble oil with the included refractometer. Thus, it is possible to optimise the tool life of the applied tool, to prevent tool breakage and subsequent production stoppage!

MQL coolant inspection instrument MQL-CHECK 3000 for measuring the coolant volume and reaction time with minimal quantity lubrication



The development of Guhring's new MQL-CHECK 3000 allows simple and quick measuring of the coolant volume and the reaction time with minimal quantity lubrication MQL directly at the tool point. For the user, the result is a considerable increase in process reliability with MQL machining.

MQL-CHECK 3000 is simply installed in the machine, the tool point is passed into the measuring opening of the measuring unit and the coolant delivery is switched on. The measuring unit of the MQL-CHECK 3000 sends the recorded data wireless to the associated display equipment, a data interface allows the transfer of data to a PC as an option, making further evaluations and above all the documentation of the measurements possible.

Subsequently, the user benefits from:

- Simple, quick measuring of the coolant volume at the tool point,
- Ascertaining the actual response time, i.e. the time from starting the system to the coolant exiting at the tool point,
- Reproducible and at any time comparable measuring data,
- A workshop suitable system, wireless operation - in terms of power supply as well as data transfer,
- Comparative measuring regarding function of MQL equipment, machine, spindle, tool holder and tool.



00

c

f

GUHRING

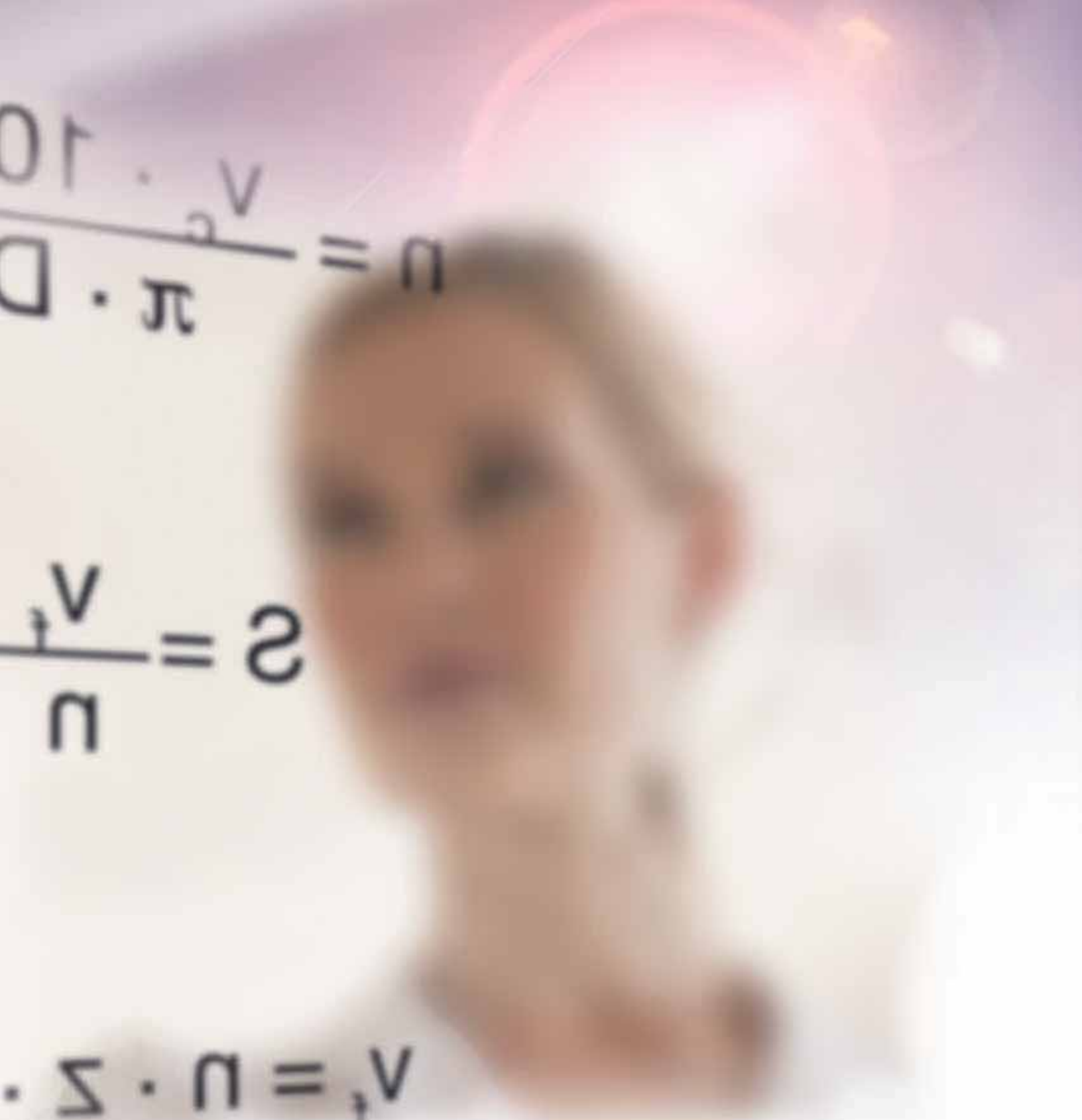

TECHNICAL SECTION

Topic	From Page
General information and operating tips	371
Dimensions	378
Shank designs	388
Machining technology: Coolant and MQL	392
Special tooling	398
Gun drilling	404
Guhring tool materials	416
Guhring coatings	422
Operating speeds and feeds	424

Decimal Equivalents - drill sizes and popular tap drill sizes (approx. 75% of thread)

Drill Size	mm	Decimal Equiv.	Tap Size	Drill Size	mm	Decimal Equiv.	Tap Size	Drill Size	mm	Decimal Equiv.	Tap Size
-	0.10	0.0039		3/32	2.38	0.0938		Q	8.43	0.3320	3/8-24
97	0.15	0.0059		41	2.44	0.0960			8.50	0.3346	M10 x 1.5
96	0.16	0.0063		40	2.50	0.0980	M3 x 0.5	R	8.61	0.3390	1/8-27 NPT
95	0.17	0.0067		39	2.53	0.0995		11/32	8.73	0.3438	
94	0.18	0.0071		38	2.58	0.1015	#5-40		8.75	0.3445	M10 x 1.25
93	0.19	0.0075		37	2.64	0.1040	#5-44	S	8.84	0.3480	1/8-27 NPS
92	0.20	0.0079		36	2.71	0.1065	#6-32	-	9.00	0.3543	M10 x 1.0
91	0.21	0.0083		7/64	2.78	0.1094		T	9.09	0.3580	
90	0.22	0.0087		35	2.79	0.1100		23/64	9.13	0.3594	
89	0.23	0.0091		34	2.82	0.1110		U	9.35	0.3680	7/16-14
88	0.24	0.0095		33	2.87	0.1130	#6-40		9.50	0.3740	M11 x 1.5
-	0.25	0.0098			2.90	0.1142	M3.5 x 0.6	3/8	9.53	0.3750	
87	0.25	0.0100		32	2.95	0.1160		V	9.56	0.3770	
-	0.26	0.0102		-	3.00	0.1181		W	9.80	0.3860	
86	0.27	0.0105		31	3.05	0.1200		25/64	9.92	0.3906	7/16-20
-	0.27	0.0106		1/8	3.18	0.1250		-	10.00	0.3937	M12 x 1.75
85	0.28	0.0110		30	3.26	0.1285		X	10.08	0.3970	
-	0.29	0.0114			3.30	0.1299	M4 x 0.7	Y	10.26	0.4040	
84	0.29	0.0115		29	3.45	0.1360	#8-32	13/32	10.32	0.4062	
-	0.30	0.0118			3.50	0.1378		Z	10.49	0.4130	M12 x 1.25
83	0.30	0.0120		28	3.57	0.1405			10.50	0.4134	
82	0.32	0.0125		9/64	3.57	0.1406		27/64	10.72	0.4219	1/2-13
-	0.32	0.0126		27	3.66	0.1440		-	11.00	0.4331	
81	0.33	0.0130		26	3.73	0.1470		7/16	11.11	0.4375	1/4-18 NPT
80	0.34	0.0135			3.75	0.1476	M4.5 x 0.75		11.50	0.4528	
79	0.37	0.0145		25	3.80	0.1495	#10-24	29/64	11.51	0.4531	1/2-20
1/64	0.40	0.0156		24	3.86	0.1520		15/32	11.91	0.4688	
78	0.41	0.0160		23	3.91	0.1540		-	12.00	0.4724	M14 x 2.0
77	0.46	0.0180		5/32	3.97	0.1562		31/64	12.30	0.4844	9/16-12
-	0.50	0.0197		22	3.99	0.1570			12.50	0.4921	M14 x 1.5
76	0.51	0.0200		-	4.00	0.1575		1/2	12.70	0.5000	
75	0.53	0.0210		21	4.04	0.1590	#10-32	-	13.00	0.5118	M14 x 1.25
74	0.57	0.0225		20	4.09	0.1610		33/64	13.10	0.5156	9/16-18
-	0.60	0.0236			4.20	0.1654	M5 x 0.8	17/32	13.49	0.5312	5/8-11
73	0.61	0.0240		19	4.22	0.1660			13.50	0.5315	
72	0.64	0.0250		18	4.31	0.1695		35/64	13.89	0.5469	
71	0.66	0.0260		11/64	4.37	0.1719		-	14.00	0.5512	M16-2
-	0.70	0.0276		17	4.39	0.1730		9/16	14.29	0.5625	
70	0.71	0.0280		16	4.50	0.1770	#12-24		14.50	0.5709	M16 x 1.5
69	0.74	0.0292		15	4.57	0.1800		37/64	14.68	0.5781	5/16-18
-	0.75	0.0295		14	4.62	0.1820	#12-28	-	15.00	0.5906	
68	0.79	0.0310		13	4.70	0.1850		19/32	15.08	0.5938	3/8-18 NPS
1/32	0.79	0.0313		3/16	4.76	0.1875		39/64	15.48	0.6094	
-	0.80	0.0315		12	4.80	0.1890			15.50	0.6102	M18 x 2.5
67	0.81	0.0320		11	4.85	0.1910		5/8	15.88	0.6250	
66	0.84	0.0330		10	4.91	0.1935		-	16.00	0.6299	M18 x 2.0
65	0.89	0.0350		9	4.98	0.1960		41/64	16.27	0.6406	
-	0.90	0.0354		-	5.00	0.1968	M6 x 1.0		16.50	0.6496	
64	0.91	0.0360		8	5.05	0.1990		21/32	16.67	0.6562	3/4-10
63	0.94	0.0370		7	5.11	0.2010	1/4-20	-	17.00	0.6693	
62	0.97	0.0380		13/64	5.16	0.2031		43/64	17.07	0.6719	
61	0.99	0.0390		6	5.18	0.2040		11/16	17.46	0.6875	3/4-16
-	1.00	0.0394		5	5.22	0.2055			17.50	0.6890	M20 x 2.5
60	1.02	0.0400			5.25	0.2067	M6 x 0.75	45/64	17.86	0.7031	
59	1.04	0.0410		4	5.31	0.2090	1/4-24	-	18.00	0.7087	M20 x 2.0
58	1.07	0.0420		3	5.41	0.2130	1/4-28	23/32	18.26	0.7188	1/2-14 NPT
57	1.09	0.0430			5.50	0.2165			18.50	0.7283	M20 x 1.5
56	1.18	0.0465		7/32	5.56	0.2188		47/64	18.65	0.7344	1/2-14 NPS
3/64	1.19	0.0469		2	5.61	0.2210		-	19.00	0.7480	
-	1.20	0.0472		1	5.79	0.2280		3/4	19.05	0.7500	
-	1.25	0.0492	M1.6 x 0.35	A	5.94	0.2340		49/64	19.45	0.7656	7/8-9
-	1.30	0.0512		15/64	5.95	0.2344			19.50	0.7677	M22 x 2.5
55	1.32	0.0520		-	6.00	0.2362	M7 x 1	25/32	19.84	0.7812	
54	1.40	0.0550		B	6.05	0.2380		-	20.00	0.7874	M22 x 2.0
-	1.45	0.0571	M1.8 x 0.35	C	6.15	0.2420		51/64	20.24	0.7969	
-	1.50	0.0591		D	6.25	0.2460	1/16-27 NPT		20.50	0.8071	M22 x 1.5
53	1.51	0.0595	#1-64	1/4	6.35	0.2500	1/16-27 NPS	13/16	20.64	0.8125	7/8-14
-	1.55	0.0610		E	6.35	0.2500		-	21.00	0.8268	M24 x 3.0
1/16	1.59	0.0625			6.50	0.2559		53/64	21.03	0.8281	
-	1.60	0.0630	M2 x 0.4	F	6.53	0.2570	5/16-18	27/32	21.43	0.8438	
52	1.61	0.0635		G	6.63	0.2610			21.50	0.8465	
-	1.65	0.0650		17/64	6.75	0.2656		55/64	21.84	0.8594	
51	1.70	0.0670	#2-56		6.75	0.2657	M8 x 1.25	-	22.00	0.8661	M24 x 2.0
-	1.75	0.0689	M2.2 x 0.45	H	6.76	0.2660		7/8	22.23	0.8750	1-8
50	1.78	0.0700	#2-64	I	6.91	0.2720	5/16-24		22.50	0.8858	M24 x 1.5
-	1.80	0.0709		-	7.00	0.2756	M8 x 1.0	57/64	22.62	0.8906	
49	1.85	0.0730		J	7.04	0.2772		-	23.00	0.9055	
-	1.90	0.0748	M2.3 x 0.4	K	7.14	0.2810		29/32	23.02	0.9062	
48	1.93	0.0760		9/32	7.14	0.2812		59/64	23.42	0.9219	3/4-14 NPT
-	1.95	0.0768		L	7.37	0.2900			23.50	0.9252	
5/64	1.98	0.0781		M	7.49	0.2949		15/16	23.81	0.9375	1-14
47	1.99	0.0785	#3-48		7.50	0.2953		-	24.00	0.9449	M27 x 3.0
-	2.00	0.0787		19/64	7.54	0.2969		61/64	24.21	0.9531	
-	2.05	0.0807	M2.5 x 0.45	N	7.67	0.3020			24.50	0.9646	
46	2.06	0.0810			7.75	0.3051	M9 x 1.25	31/32	24.61	0.9688	
45	2.08	0.0820	#3-56	5/16	7.94	0.3125	3/8-16	-	25.00	0.9843	M27 x 2.0
-	2.15	0.0846	M2.6 x 0.45	-	8.00	0.3150		63/64	25.00	0.9844	1-1/8-7
44	2.18	0.0860	#4-36	O	8.03	0.3160		1	25.40	1.0000	
43	2.26	0.0890	#4-40	P	8.20	0.3230					
42	2.37	0.0935	#4-48	21/64	8.33	0.3281					

Technical

Outside Diameter (O.D.) Manufacturing Tolerances

Twist drills

h5 Tolerance Range	
Ø-range mm	tolerance range mm
≤ 3.000	+0.000 / -0.004
> 3.000 - 6.000	+0.000 / -0.005

h6 Tolerance Range	
Ø-range mm	tolerance range mm
> 0.600 - 0.950	+0.000 / -0.005
> 0.950 - 3.000	+0.000 / -0.006
> 3.000 - 6.000	+0.000 / -0.008
> 6.000 - 10.000	+0.000 / -0.009
> 10.000 - 18.000	+0.000 / -0.011
> 18.000 - 30.000	+0.000 / -0.013
> 30.000 - 50.000	+0.000 / -0.016

h8 Tolerance Range	
Ø-range mm	tolerance range mm
0.380 - 0.600	+0.000 / -0.010
> 0.600 - 0.950	+0.000 / -0.012
> 0.950 - 3.000	+0.000 / -0.014
> 3.000 - 6.000	+0.000 / -0.018
> 6.000 - 10.000	+0.000 / -0.022
> 10.000 - 18.000	+0.000 / -0.027
> 18.000 - 30.000	+0.000 / -0.033
> 30.000 - 50.000	+0.000 / -0.039

h7 Tolerance Range	
Ø-range mm	tolerance range mm
0.380 - 0.600	+0.000 / -0.007
> 0.600 - 0.950	+0.000 / -0.008
> 0.950 - 3.000	+0.000 / -0.010
> 3.000 - 6.000	+0.000 / -0.012
> 6.000 - 10.000	+0.000 / -0.015
> 10.000 - 18.000	+0.000 / -0.018
> 18.000 - 30.000	+0.000 / -0.021
> 30.000 - 50.000	+0.000 / -0.025

m7 Tolerance Range	
Ø-range mm	tolerance range mm
0.800 - 3.000	+0.002 / +0.012
3.000 - 6.000	+0.004 / +0.016
> 6.000 - 10.000	+0.006 / +0.021
> 10.000 - 18.000	+0.007 / +0.025
> 18.000 - 30.000	+0.008 / +0.029

Center drills

DIN 333	
Ø-range mm	tolerance range mm
0.50 - 2.50	0 +0.14
3.15 - 5.00	0 +0.18
6.30 - 10.00	0 +0.22
12.50	0 +0.27

to B.S. 328	
Ø-range mm	tolerance range mm
1.19 - 1.59	0 ±0.05
2.38 - 3.17	0 ±0.07
4.76	0 ±0.07
6.35 - 7.94	0 ±0.12

to ASA	
Ø-range mm	tolerance range mm
all	0 + 0.07 mm

Typical hole quality characteristics

1. in 42CrMo4V, Ø 14.5 mm

HSS drills, type N Guhring no. 651 **S**

vc = 25 m/min
f = 0.25 mm/rev.
+Rmax = 131.8 µm
-Rmax = -49.1 µm
actual D = 14.566 mm
dRmax = 103.5 µm
AV = 49.2 µm
Ra = 2.6 µm, Rz = 6.8 µm **IT12**

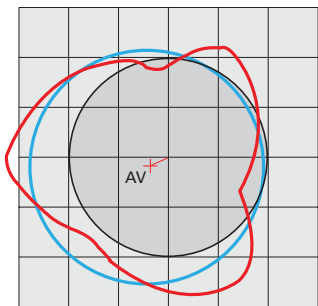

Ratio drills, type RT 80 Guhring no. 1171 **S**

vc = 70 m/min
f = 0.25 mm/rev.
+Rmax = 42.7 µm
-Rmax = -29.6 µm
actual D = 14.515 mm
dRmax = 12.9 µm
AV = 35.3 µm
Ra = 1.4 µm, Rz = 4.31 µm **IT9**

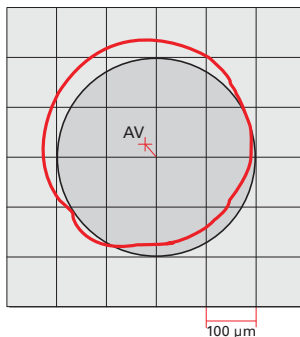

Ratio drills, type RT 100 Guhring no. 1181 **S**

vc = 70 m/min
f = 0.25 mm/rev.
+Rmax = 26.7 µm
-Rmax = -17.2 µm
actual D = 14.509 mm
dRmax = 5.2 µm
AV = 22.8 µm
Ra = 1.04 µm, Rz = 3.2 µm **IT8**

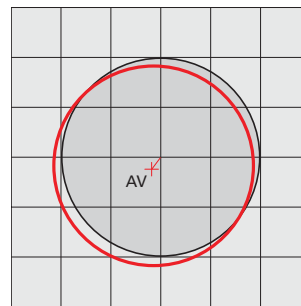

The overall total of the maximum positive and negative deviations is the sum of the total run-out in relation to the black circle as measured on standard instruments (dRmax). The red lines at the hole centres indicate the direction and amplitude of the displacements AV (Axis Shifting) of the produced hole from the true centre point. The parameter showing the largest deviation is decisive for the IT quality class of the hole in relation to the tool diameter.

The black circle in the diagram represents the nominal hole diameter which the tool should ideally produce. The red circle indicates the form actually produced. The mean value of the radius of the red circle, i.e. the average diameter, is shown by the blue circle. (with our Ratio drills the average diameter is practically identical to the actual diameter produced).

2. in GGG40, Ø 10.0 mm

HSS drills, type N Guhring no. 651 **S**

vc = 30 m/min
f = 0.2 mm/rev.
actual D = 10.077 mm
+Rmax = 106 µm
-Rmax = -28 µm
dRmax = 42 µm
AV = 68.5 µm
Ra = 3.7 µm, Rz = 17.2 µm **IT12**

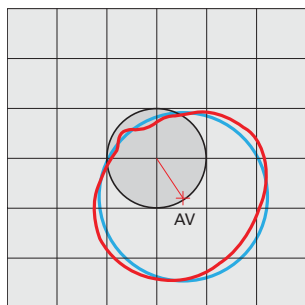

Ratio drills, type RT 100 Guhring no. 1181 **S**

vc = 90 m/min
f = 0.3 mm/rev.
actual D = 10.027 mm
+Rmax = 34 µm
-Rmax = -9.2 µm
dRmax = 6.5 µm
AV = 22.5 µm
Ra = 2.2 µm, Rz = 11.5 µm **IT9**

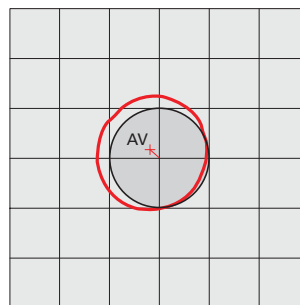

Ratio drills, type RT 150 GG Guhring no. 768 **O**

vc = 130 m/min
f = 0.2 mm/rev.
actual D = 9.994 mm
+Rmax = 11.5 µm
-Rmax = -18 µm
dRmax = 5 µm
AV = 14 µm
Ra = 1.99 µm, Rz = 11.2 µm **IT8**

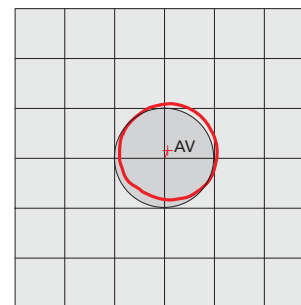

Cutting edge build-up

Cause:

- Low cutting speed
- Excessive honing of cutting lip
- Bright finish cutting lip

Remedy:

- Increase cutting speed
- Reduce cutting lip honing
- Have tool coated

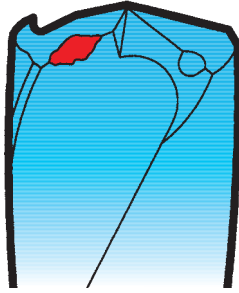

Crumbling of outer corners

Cause:

- Non-rigid conditions, insufficient work piece clamping
- Excessive deviation from concentricity
- Interrupted cut

Remedy:

- Rigid clamping of work piece
- Check and correct concentricity if possible
- Reduce feed

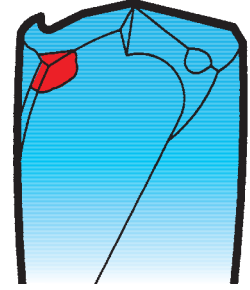

Heavy wear and tear at flank

Cause:

- Cutting speed too high
- Feed too low
- Clearance angle too small

Remedy:

- Decrease cutting speed
- Increase feed
- Increase clearance angle

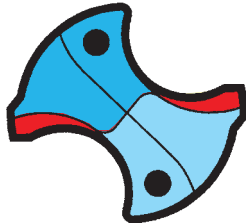

Crumbling on cutting lips

Cause:

- Non-rigid conditions, insufficient work piece clamping
- Interrupted cut
- Maximum wear and tear values have been exceeded
- Wrong tool type

Remedy:

- Rigid clamping of work piece
- Reduce feed
- Reduce tool change intervals
- Apply suitable tool (see application recommendations)

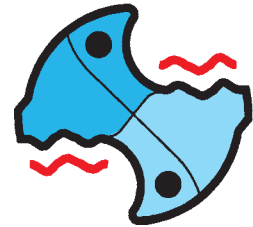

Land wear

Cause:

- Non-rigid conditions, insufficient work piece clamping
- Large deviation from concentricity
- Back taper too small
- Wrong coolant/lubrication (oil), soluble oil too thin

Remedy:

- Rigid clamping of work piece
- Check and correct concentricity if possible
- Increase back taper
- Thicken soluble oil or use neat oil

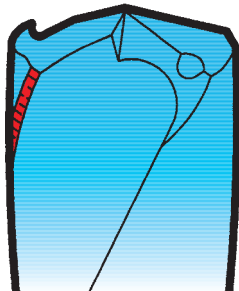

Scoring on tool body

Cause:

- Non-rigid conditions, insufficient work piece clamping
- Large deviation from concentricity
- Interrupted cut
- Abrasive work piece material

Remedy:

- Rigid clamping of work piece
- Check and correct concentricity if possible
- Reduce feed
- Thicken soluble oil or use neat oil

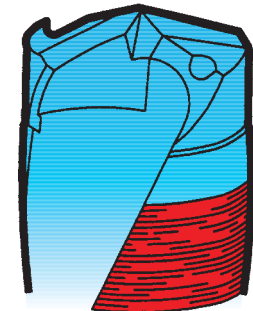

Heavy chisel edge wear and tear

Cause:

- Cutting speed too low
- Feed too high
- Excessive honing of cutting lip

Remedy:

- Increase cutting speed
- Decrease feed
- Reduce cutting lip honing

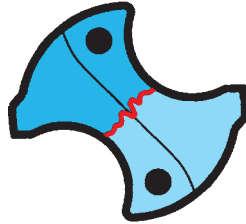

Crumbling at intersection of web thinning and cutting lip

Cause:

- Clearance angle too small
- Excessive honing of cutting lip
- Wrong tool type

Remedy:

- Increase clearance angle
- Reduce cutting lip honing
- Apply suitable tool

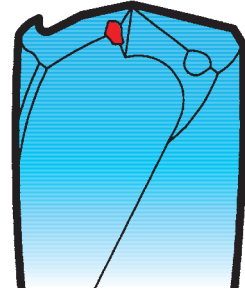

Plastic deformation of outer corner

Cause:

- Cutting speed too high
- Incorrect or no honing at corner
- Incorrect or no corner chamfer

Remedy:

- Decrease cutting speed
- Correct honing
- Apply correct corner chamfer

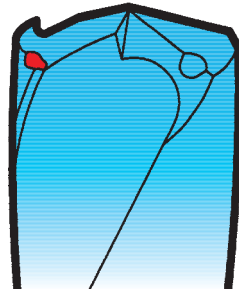

Misalignment, axis shifting

Cause:

- Non-rigid conditions, insufficient work piece clamping
- Excessive deviation from concentricity
- Spotting area transverse
- Chisel edge too large

Remedy:

- Rigid clamping of work piece
- Check and correct concentricity, if possible
- Use twin-fluted milling cutter for spotting
- Reduce chisel edge

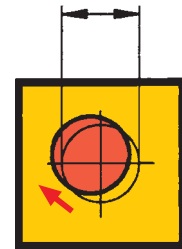

Heavy burring on breakthrough

Cause:

- Feed too high
- Maximum wear and tear values have been exceeded
- Excessive honing of cutting lip

Remedy:

- Decrease feed
- Reduce tool change intervals
- Reduce cutting lip honing

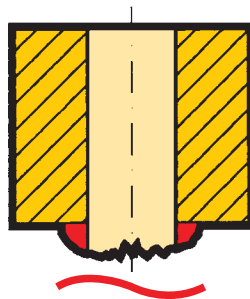

Unsatisfactory surface quality

Cause:

- Non-rigid conditions, insufficient work piece clamping
- Excessive deviation from concentricity
- Insufficient coolant

Remedy:

- Rigid clamping of work piece
- Check and correct concentricity, if possible
- Increase coolant (volume, pressure)

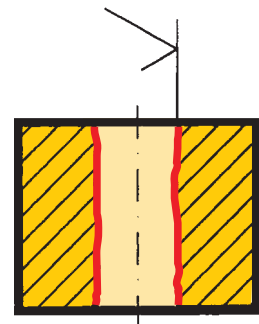

Feed Force and Torque Requirements - Carbide Drills

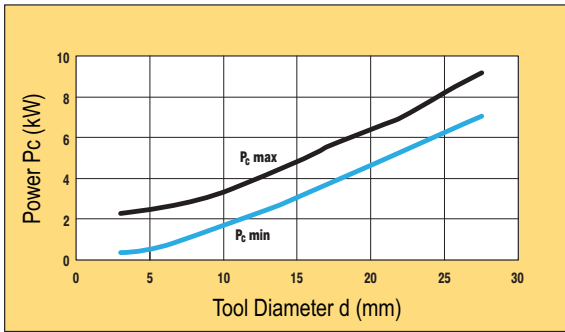

Required power when drilling steel with RT drills (1,000 N/mm²)

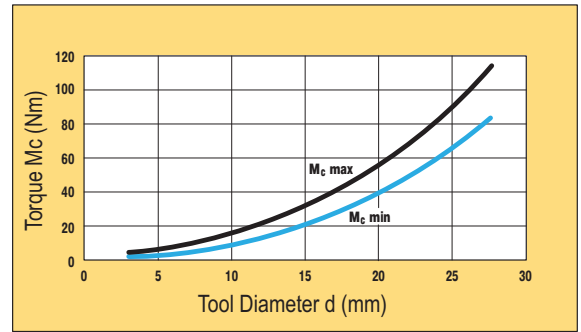

Required machine torque for drilling steel with RT 100 drills (1,000 N/mm²)

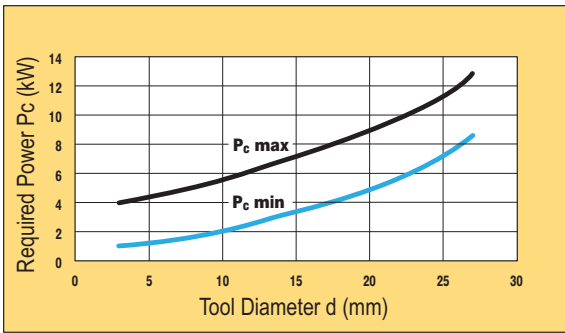

Required power when drilling cast iron with RT 100 drills

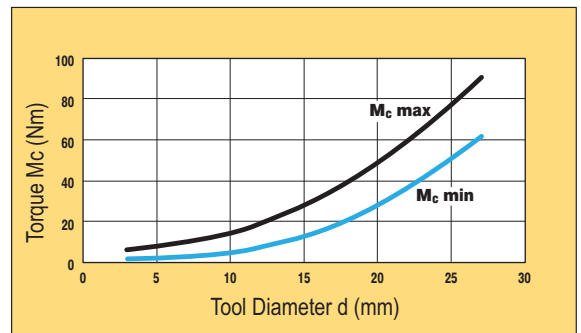

Required machine torque when drilling cast iron with RT 100 drills

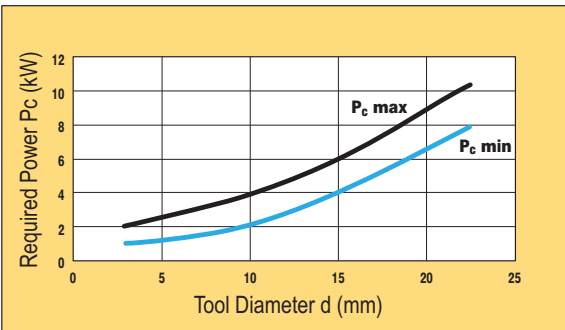

Required power when drilling AISi7 with RT 100 drills

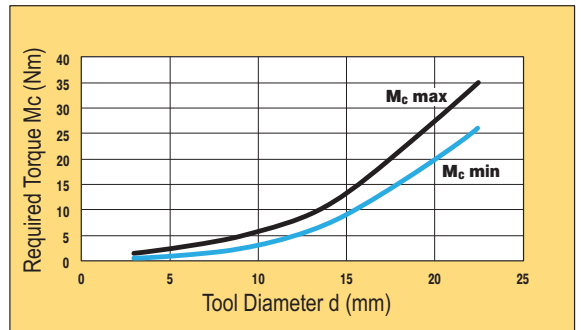

Required machine torque when drilling AISi7 with RT 100 drills

Feed Force and Torque Requirements - Carbide Drills

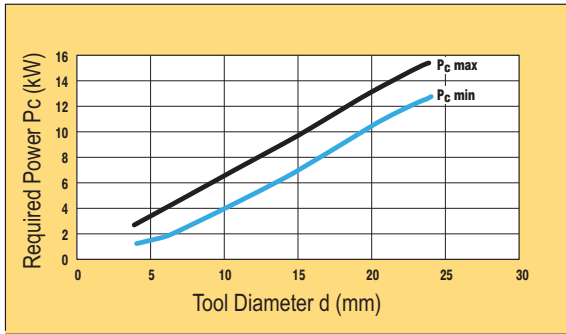

Required power when drilling cast iron with RT 150 GG drills. $V_c = 140$ m/min.

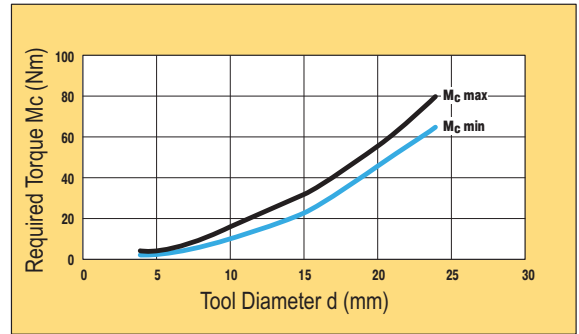

Required machine torque for drilling cast iron with RT 150 GG drills. $V_c = 140$ m/min.

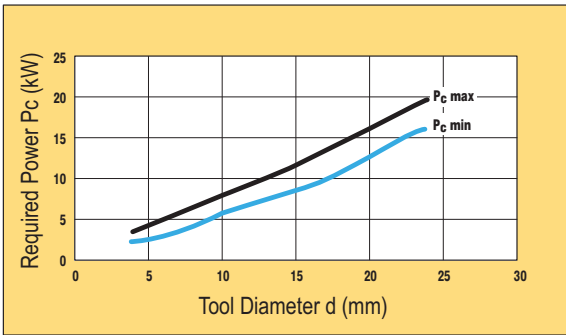

Required power when drilling AISi7 with RT 150 GG drills. $V_c = 400$ m/min.

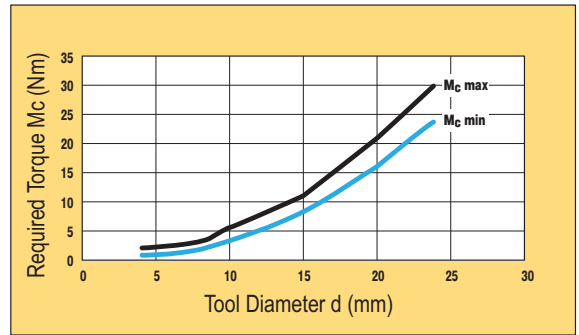

Required machine torque for drilling AISi7 with RT 150 GG drills. $V_c = 400$ m/min.

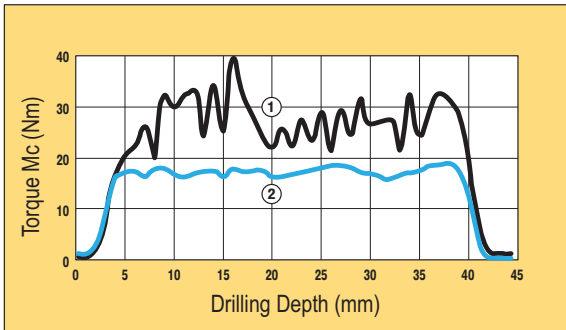

Torque curves for machining steel ($1,000 \text{ N/mm}^2$) with a new (2) and a worn (1) RT100 drill. $v_c = 70$ m/min, $f = .25$ mm/U, $p = 40$ bar.

Coolant pressure and volumes

The illustrated optimum, good and minimum required coolant volume apply only to spiral-fluted Ratio drills type RT 100. In contrast to the pressure, which is a feature of the machine tool; the cooling system fitted to it and also the possibility of leakage, volume does not depend on the machine (fig. 1). The pressure figures given are therefore recommendations which serve only as guidelines.

Ratio drills type RT 80 with central coolant duct are subject to different standards (fig. 2). The diagrams shown are for Ratio drills in their most important application, machining of steel.

But they are also guidelines for the machining of other materials, primarily because the highest coolant pressures are constantly required for the machining of steel. The effects of cooling using straight-fluted Ratio drills type RT 150 is particularly sensitive and is clearly demonstrated

in the examples for particular work piece materials. For example, the loss in tool life through low pressures when machining grey cast iron is considerably higher than when machining AlSi alloys. But this is only the case when the AlSi alloy is short-chipping! The absolute necessary minimum pressure or good pressure should, when machining cast iron, be generally a little higher than for AlSi machining (figures 3 and 4).

The recommended values are to be used only for drilling depths of up to approx. 5 x D. Deeper holes should be produced with tools having internal coolant ducts, as for example RT 150 GN, otherwise the production of deeper holes (depending on the material) becomes uneconomical.

Required coolant pressures
█ optimum pressure
█ good pressure
█ minimum pressure

Required coolant volumes
█ optimum volume
█ good volume
█ minimum volume

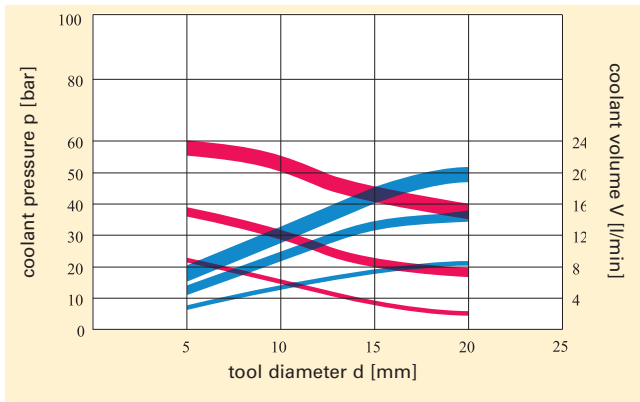

fig. 1: Required coolant pressures and volumes for RT 100 Ratio drills with internal spiral coolant ducts.

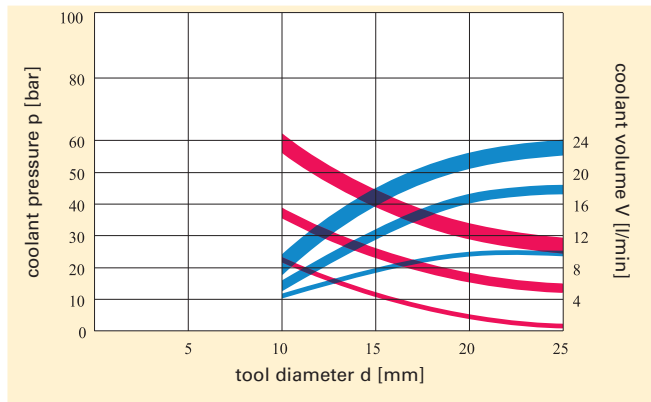

fig. 2: Required coolant pressures and volumes for RT 80 Ratio drills with central internal coolant duct.

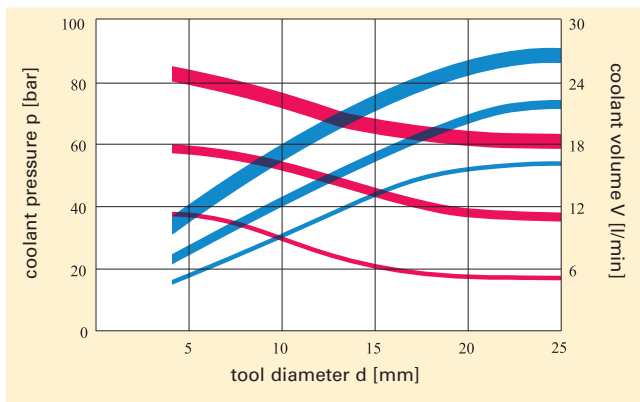

fig. 3: Required coolant pressures and volumes for straight-fluted Ratio drill type 150 GG when machining cast iron.

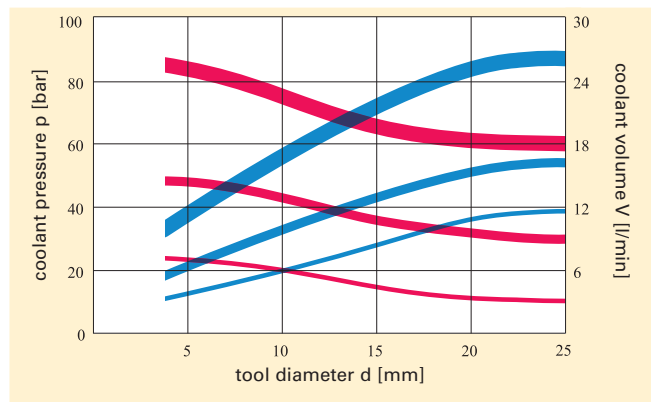
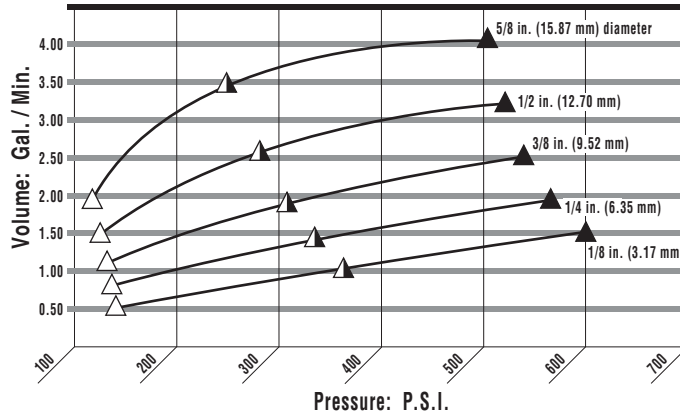

fig. 4: Required coolant pressures and volumes for straight-fluted Ratio drill type 150 GG when machining AlSi7.

Coolant pressure and volumes

RT 100 U, F & C



△ = Minimum ▲ = Good ▲ = Optimum

RT 150 GG

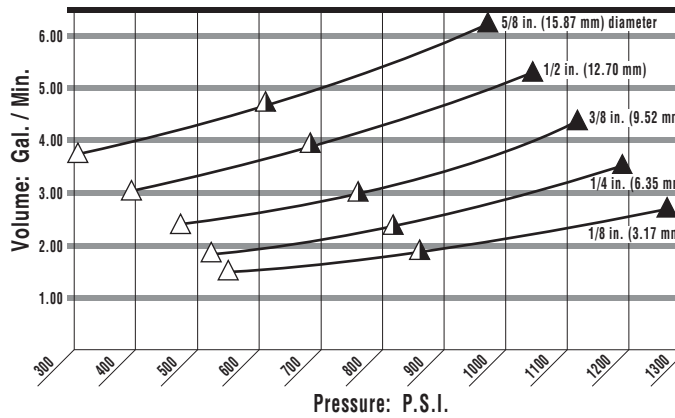

△ = Minimum ▲ = Good ▲ = Optimum

HT 800 WP

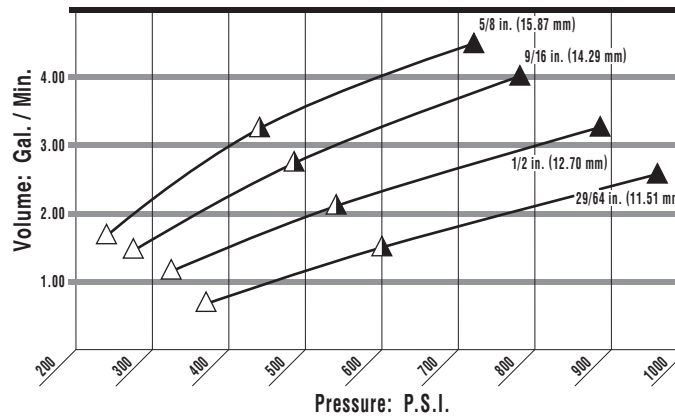

△ = Minimum ▲ = Good ▲ = Optimum

RT 800 WP

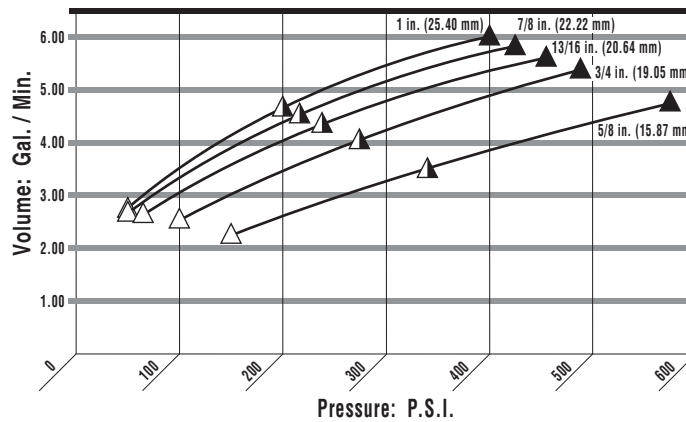

Definitions, dimensions and angles DIN ISO 5419 (extract; edition 06/98)

Twist drills with straight/Morse taper shank

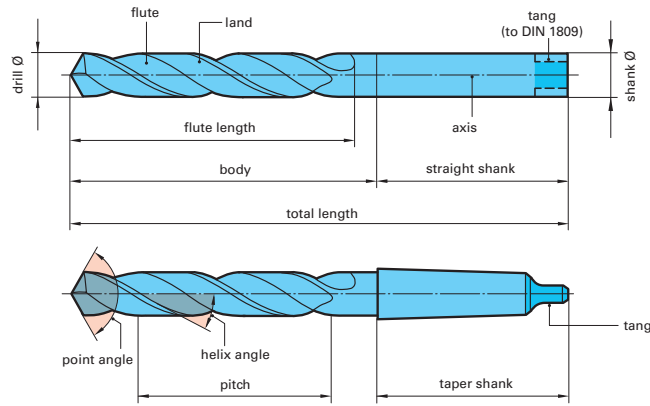

Cutting portion

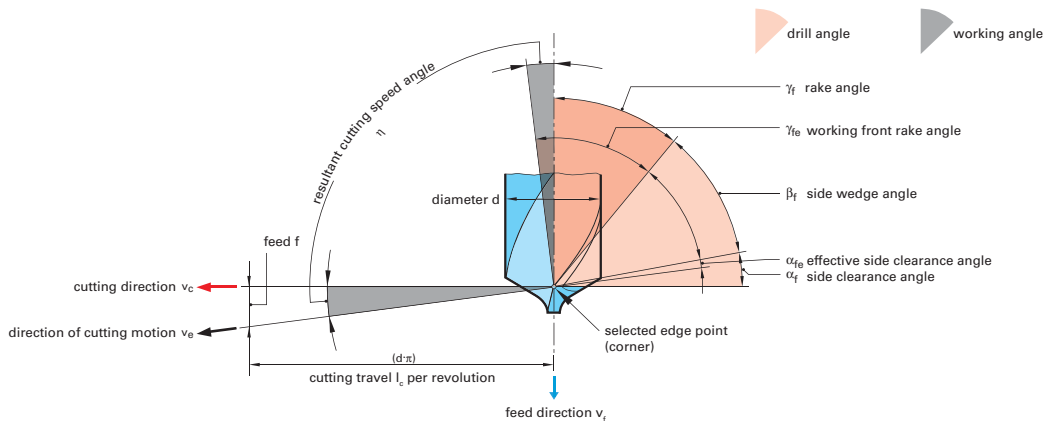
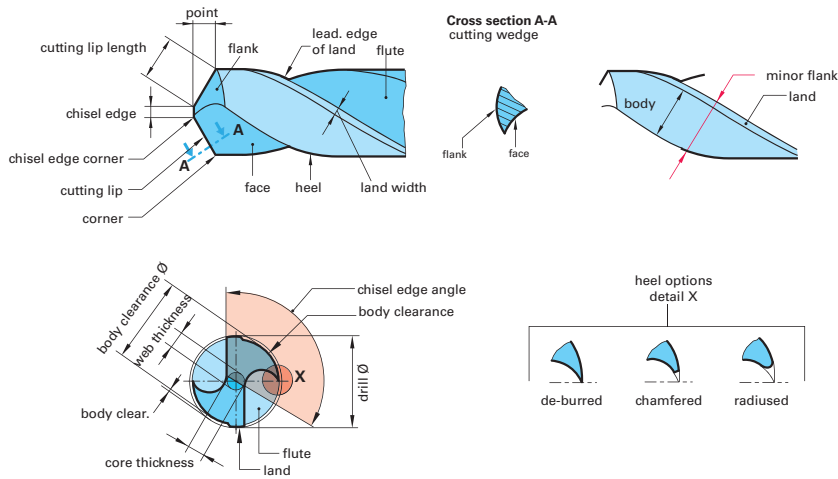

Straight shank twist drills

dia. to (incl.) mm	DIN 338		DIN 339		DIN 340		DIN 1897		DIN 1869 Extra length twist drills					
	total length mm	flute length	total length mm	flute length	total length mm	flute length	total length mm	flute length	series 1		series 2		series 3	
									total length mm	flute length	total length mm	flute length	total length mm	flute length
≤ 0.24	19	2.5					19	1.5						
0.30	19	3					19	1.5						
0.38	19	4					19	2						
0.48	20	5			30*	10*	19	2.5						
0.53	22	6			32*	12*	20	3						
0.60	24	7	32*	15*	35*	15*	21	3.5						
0.67	26	8	36*	18*	38*	18*	22	4						
0.75	28	9	39*	20*	42*	21*	23	4.5						
0.85	30	10	42*	22*	46*	25*	24	5						
0.95	32	11	45*	24*	51*	29*	25	5.5						
1.06	34	12	48	26	56	33	26	6						
1.18	36	14	50	28	60	37	28	7						
1.32	38	16	52	30	65	41	30	8						
1.50	40	18	55	33	70	45	32	9						
1.70	43	20	58	35	76	50	34	10	115*	75*				
1.90	46	22	62	38	80	53	36	11	120*	80*				
2.12	49	24	66	41	85	56	38	12	125	85	160*	110*	205*	135*
2.36	53	27	70	44	90	59	40	13	135	90	170*	115*	215*	145*
2.65	57	30	74	47	95	62	43	14	140	95	180*	120*	225*	150*
3.00	61	33	79	51	100	66	46	16	150	100	190	130	240*	160*
3.35	65	36	84	55	106	69	49	18	155	105	200	135	250*	170*
3.75	70	39	91	60	112	73	52	20	165	115	210	145	265	180
4.25	75	43	96	64	119	78	55	22	175	120	220	150	280	190
4.75	80	47	102	69	126	82	58	24	185	125	235	160	295	200
5.30	86	52	108	74	132	87	62	26	195	135	245	170	315	210
6.00	93	57	116	80	139	91	66	28	205	140	260	180	330	225
6.70	101	63	124	86	148	97	70	31	215	150	275	190	350	235
7.50	109	69	133	93	156	102	74	34	225	155	290	200	370	250
8.50	117	75	142	100	165	109	79	37	240	165	305	210	390	265
9.50	125	81	151	107	175	115	84	40	250	175	320	220	410	280
10.60	133	87	162	116	184	121	89	43	265	185	340	235	430	295
11.80	142	94	173	125	195	128	95	47	280*	195*	365*	250*	455*	310*
13.20	151	101	184	134	205	134	102	51	295*	205*	375*	260*	480*	330*
14.00	160	108	194	142	214	140	107	54						
15.00	169	114	202	147	220	144	111	56						
16.00	178	120	211	153	227	149	115	58						
17.00	184	125	218	159	235	154	119	60						
18.00	191	130	226	165	241	158	123	62						
19.00	198	135	234	171	247	162	127	64						
20.00	205	140	242	177	254	166	131	66						
21.20					261	171	136	68						
22.40					268	176	141	70						
23.60					275	180	146	72						
25.00					282	185	151	75						
26.50					290	190	156	78						
28.00					298	195	162	81						
30.00					307	201	168	84						
31.50					316	207	174	87						
33.50							180	90						
35.50							186	93						
37.50							193	96						
40.00							200	100						
42.50							207	104						
45.00							214	108						
47.50							221	112						
50.00							228	116						

* Guhring std.

Carbide twist drills (Ratio drills)

Carbide twist drills (Ratio drills) DIN 6537

Applies to solid carbide twist drills with 2 or 3 cutting edges and straight shank to DIN 6535

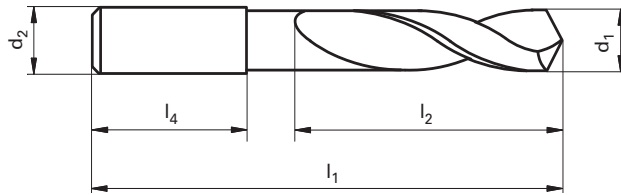

Dimensions in mm

nom. Ø-range up to d1m7	shank Ø d2h6	Ratio drills for 3 x D		Ratio drills for 5 x D		shank length l4
		overall length l1	max. flute length l2	overall length l1	max. flute length l2	
2.9...3.75	6	62	20	66	28	36
4.75	6	66	24	74	36	36
6.00	6	66	28	82	44	36
7.00	8	79	34	91	53	36
8.00	8	79	41	91	53	36
10.00	10	89	47	103	61	40
12.00	12	102	55	118	71	45
14.00	14	107	60	124	77	45
16.00	16	115	65	133	83	48
18.00	18	123	73	143	93	48
20.00	20	131	79	153	101	50

Carbide twist drills (Ratio drills) DIN 6538

Applies to twist drills with brazed carbide tip or head with reinforced straight shank (steel) to DIN 6535. The brazed head can be a part or the complete cutting portion.

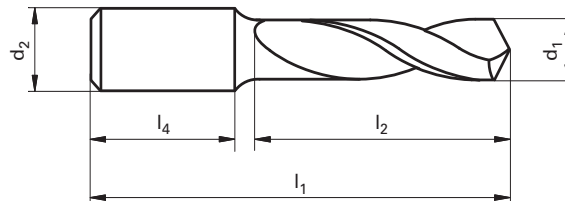

Dimensions in mm

nom. Ø-range up to d1h7	shank Ø d2h6	Ratio drills for 3 x D		Ratio drills for 5 x D		Ratio drills for 7 x D		shank length l4
		overall length l1	max. flute length l2	overall length l1	max. flute length l2	overall length l1	max. flute length l2	
9.5...12.0	16	103	51	127	75	151	99	48
14.0	16	111	59	139	87	167	115	48
16.0	20	122	68	154	100	186	132	50
18.0	20	130	76	166	112	202	148	50
20.0	25	144	84	184	124	224	164	56
22.0	25	153	93	197	137	241	181	56
24.0	25	161	101	209	149	257	197	56
26.0	32	174	110	226	162	278	214	60
28.0	32	182	118	238	174	294	230	60
30.0	32	190	126	250	186	310	246	60

Carbide twist drills (Ratio drills)

Carbide twist drills (Ratio drills) DIN 6539

Applies to solid carbide twist drills with parallel shank, i.e. equal nom. drill and shank diameter.

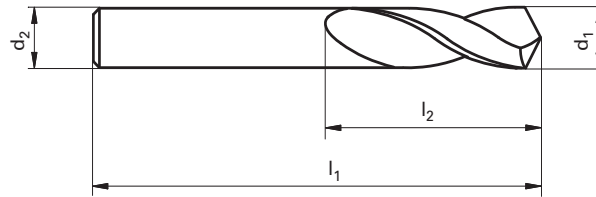

Dimensions in mm

nom. Ø-range up to (= shank Ø d2) d1	overall length		flute length	
	l1		l2	
1.90...2.12	38	12		
2.36	40	13		
2.65	43	14		
3.00	46	16		
3.35	49	18		
3.75	52	20		
4.25	55	22		
4.75	58	24		
5.30	62	26		
6.00	66	28		
6.70	70	31		
7.50	74	34		
8.00	79	37		
8.50	79	37		
9.50	84	40		

nom. Ø-range up to (= shank Ø d2) d1	overall length		flute length	
	l1		l2	
10.00	89	43		
10.60	89	43		
11.80	95	47		
12.00	102	51		
13.20	102	51		
14.00	107	54		
15.00	111	56		
16.00	115	58		
17.00	119	60		
18.00	123	62		
19.00	127	64		
20.00	131	66		

Morse taper twist drills

dia. to (incl.) mm	DIN 345			DIN 346			DIN 341			Bushing drills with oversize taper*			GV/VA-drills* for drilling difficult materials			DIN 1870 Extra length twist drills					
	total length	flute length	Morse taper	total length	flute length	Morse taper	total length	flute length	Morse taper	total length	flute length	Morse taper	total length	flute length	Morse taper	series 1			series 2		
																total length	flute length	Morse taper	total length	flute length	Morse taper
mm	mm	mm	mm	mm	mm	mm	mm	mm	mm	mm	mm	mm	mm	mm	mm	mm	mm	mm			
2.65	111*	30*	1*																		
3.00	114	33	1																		
3.35	117	36	1																		
3.75	120	39	1																		
4.25	124	43	1				145*	64*	1*												
4.75	128	47	1				150*	69*	1*												
5.30	133	52	1				155	74	1												
6.00	138	57	1				161	80	1												
6.70	144	63	1				167	86	1												
7.50	150	69	1				174	93	1												
8.50	156	75	1				181	100	1			130	49	1	265	165	1	330	210	1	
9.50	162	81	1				188	107	1			134	53	1	275	175	1	345	220	1	
10.60	168	87	1	185*	87*	2*	197	116	1	214	116	2	138	57	1	285	185	1	360	235	1
11.80	175	94	1	192*	94*	2*	206	125	1	223	125	2	142	61	1	300	195	1	375	250	1
13.20	182	101	1	199	101	2	215	134	1	232	134	2	147	66	1	310	205	1	395	260	1
14.00	189	108	1	206	108	2	223	142	1	240	142	2	168	70	2	325	220	1	410	275	1
15.00	212	114	2	235*	114*	3*	245	147	2	268	147	3	172	74	2	340	220	2	425	275	2
16.00	218	120	2	241*	120*	3*	251	153	2	274	153	3	176	78	2	355	230	2	445	295	2
17.00	223	125	2	246*	125*	3*	257	159	2	280	159	3	179	81	2	355	230	2	445	295	2
18.00	228	130	2	251*	130*	3*	263	165	2	286	165	3	183	85	2	370	245	2	465	310	2
19.00	233	135	2	256	135	3	269	171	2	292	171	3	186	88	2	370	245	2	465	310	2
20.00	238	140	2	261	140	3	275	177	2	298	177	3	212	91	3	385	260	2	490	325	2
21.20	243	145	2	266	145	3	282	184	2	305	184	3	216	95	3	385	260	3	490	325	3
22.40	248	150	2	271	150	3	289	191	2	312	191	3	219	98	3	405	270	3	515	345	3
23.02	253	155	2	276	155	3	296	198	2	319	198	3	222	101	3	405	270	3	515	345	3
23.60	276	155	3	304*	155*	4*	319	198	3	347	198	4	222	101	3	425	270	3	535	345	3
25.00	281	160	3	309*	160*	4*	327	206	3	355	206	4	225	104	3	440	290	3	555	365	3
26.50	286	165	3	314*	165*	4*	335	214	3	363	214	4	256	107	4	440	290	3	555	365	3
28.00	291	170	3	319	170	4	343	222	3	371	222	4	259	110	4	460	305	3	580	385	3
30.00	296	175	3	324	175	4	351	230	3	379	230	4	263	114	4	460	305	3	580	385	3
31.50	301	180	3	329	180	4	360	239	3	388	239	4	266	117	4	480	320	3	610	410	3
31.75	306	185	3	334	185	4	369	248	3	397	248	4	269	120	4	480	320	3	610	410	3
33.50	334	185	4	372*	185*	5*	397	248	4	435	248	5	269	120	4	505	320	4	635	410	4
35.50	339	190	4	377*	190*	5*	406	257	4				272	123	4	530	340	4	665	430	4
37.50	344	195	4	382*	195*	5*	416	267	4				276	127	4	530	340	4	665	430	4
40.00	349	200	4	387*	200*	5*	426	277	4				317	130	5	555	360	4	695	460	4
42.50	354	205	4	392	205	5	436	287	4				320	133	5	555	360	4	695	460	4
45.00	359	210	4	397	210	5	447	298	4				323	136	5	585	385	4	735	490	4
47.50	364	215	4	402	215	5	459	310	4							585	385	4	735	490	4
50.00	369	220	4	407	220	5	470	321	4							605	405	4	765	510	4
50.80	374	225	4	412	225	5	475*	326*	4*												
53.00	412	225	5	479*	225*	6*	513*	326*	5*												
56.00	417	230	5	484*	230*	6*	518*	331*	5*												
60.00	422	235	5	489*	235*	6*	523*	336*	5*												
63.00	427	240	5	494*	240*	6*															
67.00	432	245	5	499	245	6															
71.00	437	250	5	504	250	6															
75.00	442	255	5	509	255	6															
76.50	447	260	5	514	260	6															
80.00	514	260	6																		
85.00	519	265	6																		
90.00	524	270	6																		
95.00	529	275	6																		
100.00	534	280	6																		
106.00	539*	285*	6*																		

* Guhring std.

Straight shank core drills

diameter up to incl. mm	DIN 344				
	overall length	flute length	diameter up to incl. mm	overall length	flute length
	mm	mm	mm	mm	mm
4.25	96*	64*	11.70	173	125
4.75	102*	69*	13.20	184	134
5.30	108	74	14.00	194	142
6.00	116	80	15.00	202	147
6.70	124	86	16.00	211	153
7.50	133	93	17.00	218	159
8.50	142	100	18.00	226	165
9.50	151	107	19.00	234	171
10.60	162	116	20.00	242	177

Shell-core drills

DIN 222		
nom. Ø up to incl. mm	overall length	nom. Ø of hole mm
mm	mm	mm
35.5	45	13
45.0	50	16
53.0	56	19
63.0	63	22
75.0	71	27
90.0	80	32
101.6	90	40

Taper shank core drills

diameter up to incl. mm	DIN 343			DIN 1864		
	overall length	flute length	Morse taper	overall length	flute length	Morse taper
	mm	mm		mm	mm	
7.50	150*	69*	1*	174*	93*	1*
8.50	156*	75*	1*	181*	100*	1*
9.50	162	81	1	188	107	1
10.60	168	87	1	197	116	1
11.70	175	94	1	206	125	1
13.20	182	101	1	215	134	1
14.00	189	108	1	223	142	1
15.00	212	114	2	245	147	2
16.00	218	120	2	251	153	2
17.00	223	125	2	257	159	2
18.00	228	130	2	263	165	2
19.00	233	135	2	269	171	2
20.00	238	140	2	275	177	2
21.20	243	145	2	282	184	2
22.40	248	150	2	289	191	2
23.60	253	155	2	296	198	2
25.00	281	160	3	327	206	3
26.50	286	165	3	335	214	3
28.00	291	170	3	343	222	3
30.00	296	175	3	351	230	3
31.50	301	180	3	360	239	3
33.50	334	185	4			
35.50	339	190	4			
37.50	344	195	4			
40.00	349	200	4			
42.50	354	205	4			
45.00	359	210	4			
47.50	364	215	4			
50.00	369	220	4			

Micro-precision drills (total length 25 mm)

*Guhring std.

DIN 1899					
diameter up to incl. mm	shank Ø	flute length	diameter up to incl. mm	shank Ø	flute length
mm	mm	mm	mm	mm	mm
from 0.1 . . . 0.12	1.0	0.5	0.67	1.0	4.2
0.15	1.0	0.8	0.75	1.0	4.8
0.19	1.0	1.1	0.79	1.0	5.3
0.24	1.0	1.5	0.85	1.5	5.3
0.30	1.0	1.9	0.95	1.5	6.0
0.38	1.0	2.4	1.06	1.5	6.8
0.48	1.0	3.0	1.18	1.5	7.6
0.53	1.0	3.4	1.32	1.5	8.5
0.60	1.0	3.9	1.45	1.5	9.5

Straight shank subland drills, 90° step angle

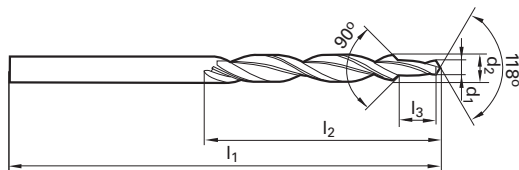

body Ø d2 h8 mm	step Ø d1 h9 mm	overall length l1 mm	flute length l2 mm	step length l3 mm	for thread	range of application
HSS DIN 8378/ Carbide Guhring std.						
3.4	2.5	70	39	8.8	M 3	For tapping size holes to DIN 336 and countersinks in accordance with clearance holes to DIN-ISO 273 (old) and DIN EN 20273 »medial tolerance«.
4.5	3.3	80	47	11.4	M 4	
5.5	4.2	93	57	13.6	M 5	
6.6	5.0	101	63	16.5	M 6	
9.0	6.8	125	81	21.0	M 8	
11.0	8.5	142	94	25.5	M10	
13.5	10.2	160	108	30.0	M12	
DIN 8374 for countersinks, fine tolerance						
6.0	3.2	93	57	9.0	M 3	For clearance holes to DIN-ISO 273 (old), DIN EN 20273 »fine tolerance« and screwhead countersinks form A and B to DIN 74 part 1 (old) »fine tolerance« and screwhead countersinks to DIN 74 form F. For screws to DIN 963 (old) and DIN 964 (old).
8.0	4.3	117	75	11.0	M 4	
10.0	5.3	133	87	13.0	M 5	
11.5	6.4	142	94	15.0	M 6	
15.0	8.4	169	114	19.0	M 8	
19.0	10.5	198	135	23.0	M10	
Guhring std. for countersinks, medial tolerance						
6.6	3.4	101	63	9.0	M 3	For clearance holes to DIN-ISO 273 (old) and screwhead countersinks form A and B to DIN 74 part 1 (old) »medial tolerance«. For screws to DIN 963 (old) and DIN 964 (old).
9.0	4.5	125	81	11.0	M 4	
11.0	5.5	142	94	13.0	M 5	
13.0	6.6	151	101	15.0	M 6	
17.2	9.0	191	130	19.0	M 8	
DIN 8374 for countersinks, medial tolerance						
7.5	3.4	109	69	9.0	M 3	For clearance holes to DIN-ISO 273 (old) and screwhead countersinks form A and B to DIN 74 part 1 (old) »medial tolerance«. For screws to DIN 963 (old) and DIN 964 (old).
9.7	4.5	133	87	11.0	M 4	
12.0	5.5	151	101	13.0	M 5	
14.5	6.6	169	114	15.0	M 6	
19.9	9.0	198	135	19.0	M 8	

Straight shank subland drills, 180° step angle

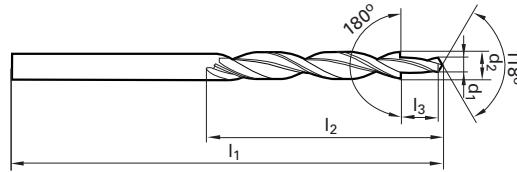

body Ø d2 h8 mm	step Ø d1 h9 mm	overall length l1 mm	flute length l2 mm	step length l3 mm	for thread	range of application
HSS DIN 8376/ Carbide Guhring std.						
6.0**	3.4	93**	57**	9.0	M 3	For clearance holes to DIN-ISO 273 (old), DIN EN 20273 »medial tolerance«, screwhead countersinks to DIN 974-1 and screwhead countersinks form H, J and K to DIN 74 part 2 (old): »medial tolerance«. For screws to DIN 84 (old), 912 (old), 6912, 7513 and DIN 7984.
6.5	3.4	101	63	9.0	M 3	
8.0	4.5	117	75	11.0	M 4	
10.0	5.5	133	87	13.0	M 5	
11.0	6.6	142	94	15.0	M 6	
15.0	9.0	169	114	19.0	M 8	
18.0	11.0	191	130	23.0	M10	
Guhring std.						
6.0	3.2	93	57	9.0	M 3	For clearance holes to DIN-ISO 273 (old) and screwhead countersinks form H, J and K to DIN 74 part 2 (old): »fine tolerance«. For screws to DIN 84 (old), 912 (old), 6912, 7513 and DIN 7984.
8.0	4.3	117	75	11.0	M 4	
Guhring std. for countersinks, fine tolerance (old*)						
5.9	3.2	93	57	11.0	M 3	For screws to DIN 84 (old), DIN 912 (old) and DIN 6912. For old type screwhead countersinks form H, J and K to DIN 75 part 2: »fine tolerance«.
7.4	4.3	109	69	13.0	M 4	
9.4	5.3	125	81	16.0	M 5	
10.4	6.4	133	87	19.0	M 6	
13.5	8.4	160	108	22.0	M 8	
16.5	10.5	184	125	25.0	M10	
Guhring std. for countersinks, medial tolerance (old*)						
8.0	4.8	117	75	13.0	M 3	For screws to DIN 84 (old), DIN 912 (old) and DIN 6912. For old type screwhead countersinks form H, J and K to DIN 75 part 2: »medial tolerance«.
10.0	5.8	133	87	16.0	M 4	
11.0	7.0	142	94	19.0	M 5	
14.5	9.5	169	114	22.0	M 6	
17.5	11.5	191	130	25.0	M 8	

* DIN 75, part 2; ** Guhring std

Morse taper subland drills, 180° step angle

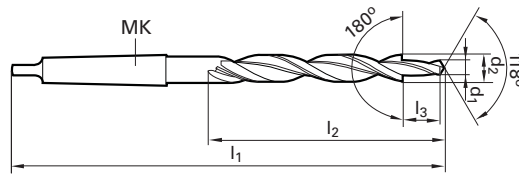

body Ø d2 h8 mm	step Ø d1 h9 mm	overall length l1 mm	flute length l2 mm	Morse taper MK	step length l3 mm	for thread	range of application					
HSS DIN 8377/ Carbide Guhring std.												
10.0	5.5	168	87	1	13.0	M 5	For clearance holes to DIN-ISO 273 (old), DIN EN 20273 »medial tolerance«, screwhead countersinks to DIN 974-1 and screwhead countersinks form H, J and K to DIN 74 part 2 (old): »medial tolerance«. For screws to DIN 84 (old), 912 (old), 6912, 7513 and DIN 7984.					
11.0	6.6	175	94	1	15.0	M 6						
15.0	9.0	212	114	2	19.0	M 8						
18.0	11.0	228	130	2	23.0	M10						
20.0	13.5	238	140	2	27.0	M12						
24.0	15.5	281	160	3	31.0	M14						
26.0	17.5	286	165	3	35.0	M16						
30.0	20.0	296	175	3	39.0	M18						
33.0	22.0	334	185	4	43.0	M20						
Guhring std.												
10.0	5.3	168	87	1	13.0	M 5	For clearance holes to DIN-ISO 273 (old) and screwhead countersinks form H, J and K to DIN 74 part 2 (old): »fine tolerance«. For screws to DIN 84 (old), 912 (old), 6912, 7513 and DIN 7984.					
11.0	6.4	175	94	1	15.0	M 6						
15.0	8.4	212	114	2	19.0	M 8						
18.0	10.5	228	130	2	23.0	M10						
20.0	13.0	238	140	2	27.0	M12						
24.0	15.0	281	160	3	31.0	M14						
26.0	17.0	286	165	3	35.0	M16						
Guhring std. for countersinks, fine tolerance (old*)												
9.4	5.3	162	81	1	16.0	M 5	For screws DIN 84 (old), DIN 912 (old) and DIN 6912. For old countersinks form H, J and K to DIN 75 part 2: »fine tolerance«.					
10.4	6.4	168	87	1	19.0	M 6						
13.5	8.4	189	108	1	22.0	M 8						
16.5	10.5	223	125	2	25.0	M10						
19.0	13.0	233	135	2	28.0	M12						
23.0	15.0	253	155	2	30.0	M14						
25.0	17.0	281	160	3	33.0	M16						
28.0	19.0	291	170	3	36.0	M18						
31.0	21.0	301	180	3	39.0	M 20						
Guhring std. for countersinks, medial tolerance (old*)												
10.0	5.8	168	87	1	16.0	M 5	For screws DIN 84 (old), DIN 6912. For old countersinks form H, J and K to DIN 75 part 2: »medial tolerance«.					
11.0	7.0	175	94	1	19.0	M 6						
14.5	9.5	212	114	2	22.0	M 8						
17.5	11.5	228	130	2	25.0	M10						
20.0	14.0	238	140	2	28.0	M12						
24.0	16.0	281	160	3	30.0	M14						
26.0	18.0	286	165	3	33.0	M16						
29.0	20.0	296	175	3	36.0	M18						
33.0	23.0	334	185	4	39.0	M20						
inch	mm	inch	mm	inches	mm	inches	mm	MK	inches	mm	for thread	range of application
British Standard												
19/32	15.08	25/64	9.92	8 5/8	219	4 3/4	121	2	3/4	19.05	3/8 inch	For British Standard caphead screws.
21/32	16.67	29/64	11.51	8 3/4	222	4 7/8	124	2	7/8	22.22	7/16 inch	
25/32	19.84	33/64	13.10	9 3/8	238	5 1/2	140	2	1	25.40	1/2 inch	

* DIN 75, part 2

Morse taper subland drills, 90° step angle

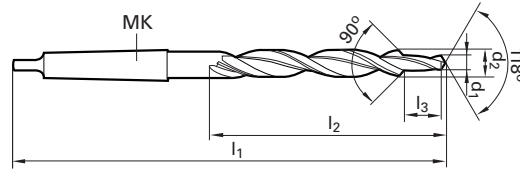

body Ø d2 h8 mm	step Ø d1 h9 mm	overall length l1 mm	flute length l2 mm	Morse taper MK	step length l3 mm	for thread	range of application
Guhring std.							
11.0	5.5	175	94	1	13.0	M 5	For clearance holes to DIN-ISO 273 (old), DIN EN 20273 »medial tolerance«, screwhead countersinks to DIN 74 form F and screwhead countersinks form A and B to DIN 74 part 1 (old) »medial tolerance«. For screws to DIN 963 (old) and DIN 964 (old).
13.0	6.6	182	101	1	15.0	M 6	
17.2	9.0	228	130	2	19.0	M 8	
21.5	11.0	248	150	2	23.0	M10	
26.0	14.0	286	165	3	27.0	M12	
29.0	16.0	296	175	3	31.0	M14	
DIN 8375							
12.0	5.5	182	101	1	13.0	M 5	For clearance holes to DIN-ISO 273 (old), DIN EN 20273 »medial tolerance«, screwhead countersinks to DIN 74 form F and screwhead countersinks form A and B to DIN 74 part 1 (old) »medial tolerance«. For screws to DIN 963 (old) and DIN 964 (old).
14.5	6.6	---	108	1	15.0	M 6	
19.0	9.0	253	135	2	19.0	M 8	
23.0	11.0	248	155	2	23.0	M10	
Guhring std.							
11.5	6.4	175	94	1	15.0	M 6	For clearance holes to DIN-ISO 273 (old) and screwhead countersinks form A and B to DIN 74 part 1 (old) »fine tolerance«. For screws to DIN 963 (old) and DIN 964 (old).
15.0	8.4	212	114	2	19.0	M 8	
19.0	10.5	233	135	2	23.0	M10	
23.0	13.0	253	155	2	27.0	M12	
26.0	15.0	286	165	3	31.0	M14	
30.0	17.0	296	175	3	35.0	M16	
DIN 8379							
9.0	6.8	162	81	1	21.0	M 8	For tapping size holes to DIN 336, DIN EN 20273 »medial tolerance« and countersinks in accordance with clearance holes to DIN-ISO 273 (old).
11.0	8.5	175	94	1	25.5	M10	
13.5	10.2	189	108	1	30.0	M12	
15.5	12.0	218	120	2	34.5	M14	
17.5	14.0	228	130	2	38.5	M16	
20.0	15.5	238	140	2	43.5	M18	
22.0	17.5	248	150	2	47.5	M20	

High speed steel straight shanks, DIN 1835-1 (extract)

Form A, plain

Dimensions in mm

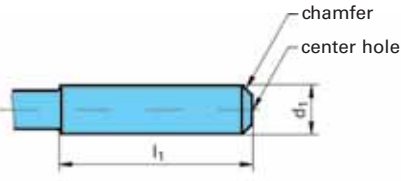
	d ₁	l ₁	d ₁	l ₁	d ₁	l ₁
	h8	+2 0	h8	+2 0	h8	+2 0
	3	28	12	45	50	80
	4	28	16	48	63	90
	5	28	20	50		
	6	36	25	56		
	8	36	32	60		
	10	40	40	70		

Form B, with drive flat

Dimensions in mm

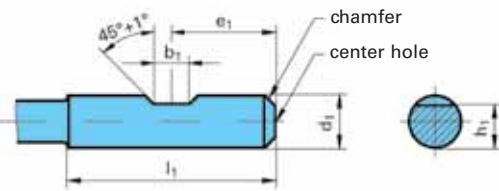
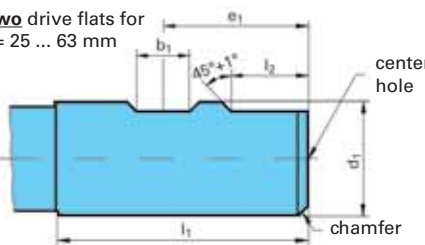
	d ₁	b ₁	e ₁	h ₁	l ₁	l ₂	center hole form R DIN 332 sect. 1
	h6	+0.05 0	0 -1	h13	+2 0	+1 0	
with one drive flat for d ₁ = 6 ... 20 mm	6	4.2	18	4.8	36	-	1.6x2.5
	8	5.5	18	6.6	36	-	1.6x3.35
	10	7	20	8.4	40	-	1.6x3.35
	12	8	22.5	10.4	45	-	1.6x3.35
	16	10	24	14.2	48	-	2.0x4.25
	20	11	25	18.2	50	-	2.5x5.3
	25	12	32	23	56	17	2.5x5.3
	32	14	36	30	60	19	3.15x6.7
	40	14	40	38	70	19	3.15x6.7
	50	18	45	47.8	80	23	3.15x6.7
	63	18	50	60.8	90	23	3.15x6.7

Form D, threaded shank

Dimensions in mm

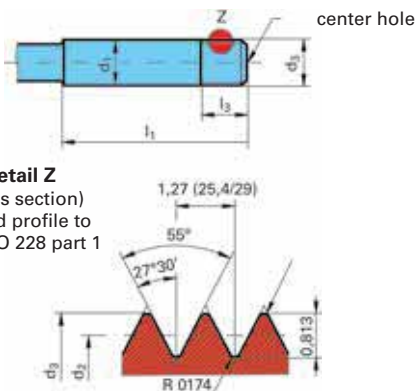
	d ₁	d ₃	tol. zone	d ₂	tol. zone	l ₁	l ₃	center hole form R DIN 332 sect. 1
	h8					+2 0	+2 0	
	6	5.9	0 -0.1	5.087	0 -0.1	36	10	1.6 x 2.5
	10	9.9	0 -0.1	9.087	0 -0.1	40	10	1.6 x 3.35
	12	11.9	0 -0.1	11.087	0 -0.1	45	10	1.6 x 3.35
	16	15.9	0 -0.1	15.087	0 -0.1	48	10	2.0 x 4.25
	20	19.9	0 -0.15	19.087	0 -0.15	50	15	2.5 x 5.3
	25	24.9	0 -0.15	24.087	0 -0.15	56	15	2.5 x 5.3
	32	31.9	0 -0.15	31.087	0 -0.15	60	15	3.15 x 6.7

Carbide straight shanks for twist drills and end mills

Form HA, plain

Dimensions in mm

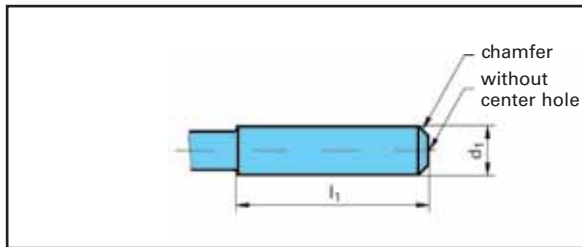

d ₁ h6	l ₁ +2 0
2	28
3	28
4	28
5	28
6	36
8	36
10	40
12	45

d ₁ h6	l ₁ +2 0
14	45
16	48
18	48
20	50
25	56
32	60

Form HB, with drive flat

Dimensions in mm

with **one** drive flat for
d₁ = 6 and 20 mm

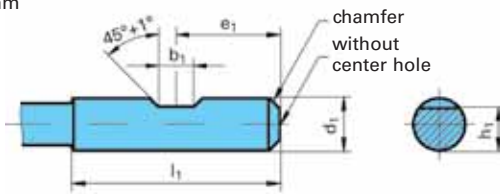

d ₁ h6	b ₁ +0.05 0	e ₁ 0 -1	h ₁ h11	l ₁ +2 0	l ₂ +1 0
6	4.2	18	5.1	36	–
8	5.5	18	6.9	36	–
10	7	20	8.5	40	–
12	8	22.5	10.4	45	–
14	8	22.5	12.7	45	–
16	10	24	14.2	48	–
18	10	24	16.2	48	–
20	11	25	18.2	50	–

with **two** drive flats for
d₁ = 25 and 32 mm

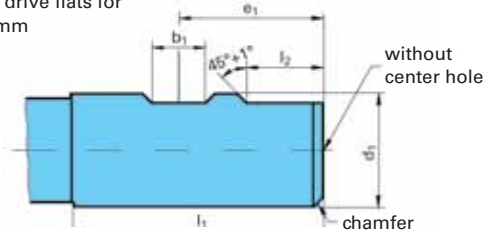

25	12	32	23	56	17
32	14	36	30	60	19

Form HE, with whistle notch flat without coolant ducts*

* Design: Straight shanks to DIN 6335 are available with or without oil feed holes. Applications for various tools, dimensions and position of oil feed holes are fully described within the standard range sections.

for d₁ = 6 to 20 mm

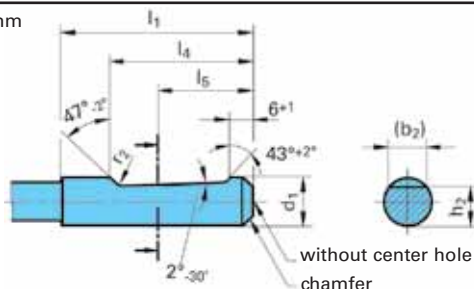

d ₁ h6	(b ₂) ≈	(b ₃)	h ₂ h11	(h ₃)	l ₁ +2 0	l ₄ 0 -1	l ₅ nom. size	r ₂ min.
6	4.3	–	5.1	–	36	25	18	1.2
8	5.5	–	6.9	–	36	25	18	1.2
10	7.1	–	8.5	–	40	28	20	1.2
12	8.2	–	10.4	–	45	33	22.5	1.2
14	8.1	–	12.7	–	45	33	22.5	1.2
16	10.1	–	14.2	–	48	36	24	1.6
18	10.8	–	16.2	–	48	36	24	1.6
20	11.4	–	18.2	–	50	38	25	1.6

for d₁ = 25 and 32 mm

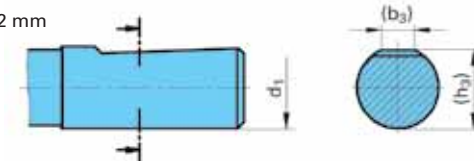

25	13.6	9.3	23.0	24.1	56	44	32	1.6
32	15.5	9.9	30.0	31.2	60	48	35	1.6

Morse taper shanks DIN 228 part 1 (extract)

Form B, Morse taper with tang

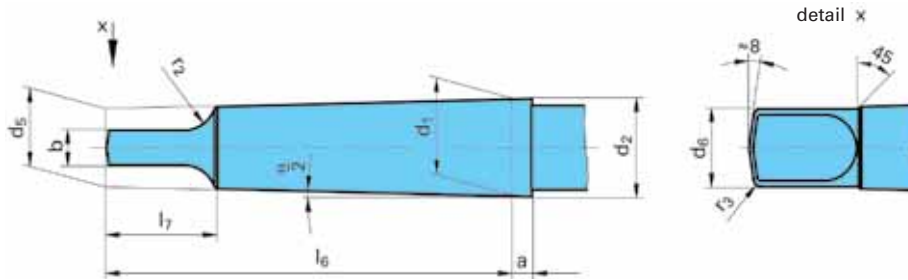

Dimensions in mm

shank to DIN 228 form B size	a limiting dim.	b	d ₁	d ₂	d ₅	d ₆ max.	l ₆	l ₇ max.	r ₂ max.	r ₅	$\frac{\alpha}{2}$
MT 1	3.5 ^{+1.4} / ₀	5.2	12.065	12.2	9.0	8.7	62	13.5	5	1.2	1°25'43"
MT 2	5.0 ^{+1.4} / ₀	6.3	17.780	18.0	14.0	13.5	75	16	6	1.6	1°25'50"
MT 3	5.0 ^{+1.7} / ₀	7.9	23.825	24.1	19.1	18.5	94	20	7	2	1°26'16"
MT 4	6.5 ^{+1.9} / ₀	11.9	31.267	31.6	25.2	24.5	117.5	24	8	2.5	1°29'15"
MT 5	6.5 ^{+1.9} / ₀	15.9	44.399	44.7	36.5	35.7	149.5	29	10	3	1°30'26"

ISO tapers for automatic tool change, DIN 69871 (extract)

Form A, with gripper groove, without through hole

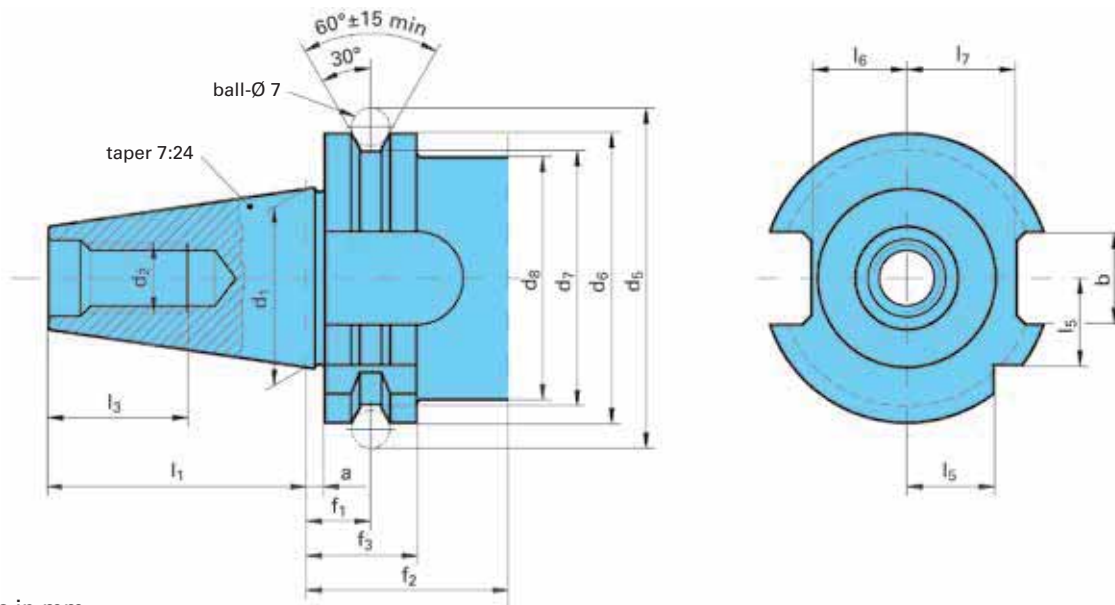

Dimensions in mm

ISO taper no.	a	b	d ₁	d ₂	d ₅	d ₆	d ₇	d ₈	f ₁	f ₂	f ₃	l ₁	l ₃	l ₅	l ₆	l ₇
	±0.1	H12			±0.05	0 -0.1	0 -0.5	max.	±0.1	min.	0 -0.1	0 -0.3	min.	0 -0.3	0 -0.4	0 -0.4
30	3.2	16.1	31.75	M12	59.3	50.00	44.30	45	11.1	35	19.1	47.8	24	15	16.4	19
40	3.2	16.1	44.45	M16	72.3	63.55	63.55	50	11.1	35	19.1	68.4	32	18.5	22.8	25
45	3.2	19.3	57.15	M20	91.35	82.55	82.55	63	11.1	35	19.1	82.7	40	24	29.1	31.3
50	3.2	25.7	69.85	M24	107.25	97.50	97.50	80	11.1	35	19.1	101.75	47	30	35.5	37.7

General overview of HSK shanks ISO 12164-1/DIN 69893

Form A DIN 69893 part 1

HSK-sizes 32...160

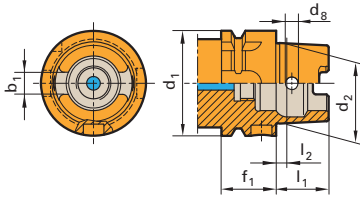

Form C DIN 69893 part 1

HSK-sizes 32...160

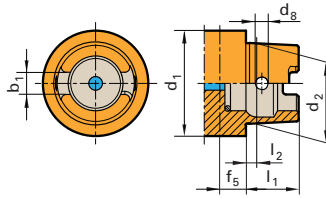

Form E DIN 69893 part 5

HSK-sizes 25...63

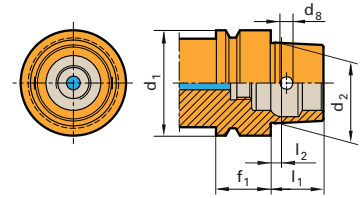

Form B DIN 69893 part 2

HSK-sizes 40...160

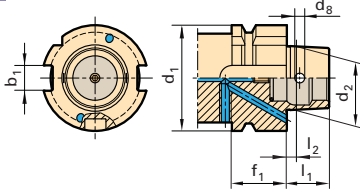

Form D DIN 69893 part 2

HSK-sizes 40...160

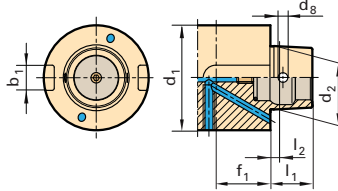

Form F DIN 69893 part 6

HSK-sizes 50...80

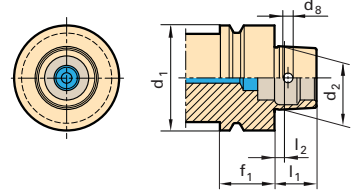

HSK for automatic tool change with gripper groove and index notch. Manual operation is via access hole in taper. Form B relies on driving dogs on the joint face as shank isn't slotted. Torque is transmitted through highly accurate connection.

HSK for manual tool change. Operation is via access hole in taper. Form D relies on driving dogs on the joint face as shank isn't slotted. Torque is transmitted through highly accurate connection.

HSK for automatic tool change. Torque is transmitted through highly accurate connection. Version with access hole acc. to DIN 69893-1 by arrangement.

HSK form A C E								
Nominal Ø d ₁ mm	d ₂ mm	l ₁ mm	l ₂ mm	f ₁ mm	f ₅ mm	d ₈ mm	b ₁ mm	
25	19.000	13	2.5	10	-	-	-	
32	24.007	16	3.2	20	10.0	4.0	7.05	
40	30.007	20	4.0	20	10.0	4.6	8.05	
50	38.009	25	5.0	26	12.5	6.0	10.54	
63	48.010	32	6.3	26	12.5	7.5	12.54	
80	60.012	40	8.0	26	16.0	8.5	16.04	
100	75.013	50	10.0	29	16.0	12.0	20.02	
125	95.016	63	12.5	29	-	-	25.02	
160	120.016	90	16.0	31	-	-	30.02	

HSK form B D F							
Nominal Ø d ₁ mm	d ₂ mm	l ₁ mm	l ₂ mm	f ₁ mm	d ₈ mm	b ₁ mm	
25	-	-	-	-	-	-	
32	-	-	-	-	-	-	
40	24.007	16	3.2	20	4.0	10	
50	30.007	20	4.0	26	4.6	12	
63	38.009	25	5.0	26	6.0	16	
80	48.010	32	6.3	26	7.5	18	
100	60.012	40	8.0	29	8.5	20	
125	75.013	50	10.0	29	12.0	25	
160	95.016	63	12.5	31	12.0	32	

Because the rotational speed is the largest influencing factor together with the limits regarding the spindle or spindle bearing interface, the following r.p.m. limits for HSK interfaces have been recommended as guidelines within the HSK standards:

HSK-A/C 32	to 50.000 rev./min
HSK-A/C 40	to 42.000 rev./min
HSK-A/C 50	to 30.000 rev./min
HSK-A/C 63	to 25.000 rev./min
HSK-A/C 80	to 20.000 rev./min
HSK-A/C 100	to 16.000 rev./min

Dry machining and minimal quantity lubrication (MQL)

Dry machining and minimal quantity lubrication (MQL) are important current technologies with the aim of reducing production costs. Guhring has invested heavily in these technologies and developed tools as well as tool holders with optimal geometries for this type of machining. An observation of the thermal conditions at the tool and the workpiece was therefore extremely important.

Basic observations

Because with dry and MQL machining, any generated heat is not dissipated via coolant like with conventional wet machining, the design of the optimized tool must ensure that.

- Heat generation is minimized during the machining process (i.e. through sharp cutting edges and a positive rake angle whilst increasing the cutting parameters),
- Friction is minimized (i.e. through a width reduction of the leading margins in comparison to the wet tool and increasing the back taper of the tool),
- Heat transfer between chip and tool is reduced (i.e. through heat insulating hard coatings and polished tool surfaces to reduce the friction between chip and face),
- Heat transfer between chip and work piece is reduced (i.e. through improved chip evacuation from the hole or from the work piece surface respectively).

Influence of rake angle on temperature

To examine this parameter, Guhring produced three drilling test tools in 10 mm diameter for a drilling depth of 100 mm. The tools were geometrically the same, however, the tools had different spirals and subsequently different rake angles. The test tools had 0° (i.e. straight-fluted), 15° and 30° rake angles. The internal coolant duct diameter of the tools was identical.

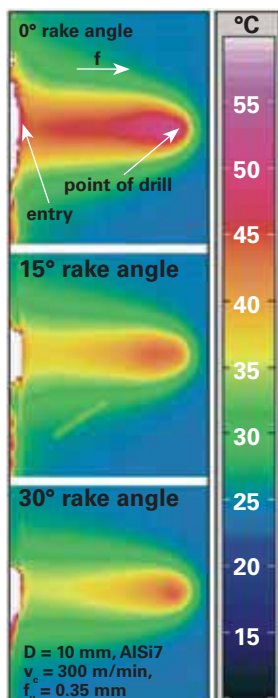

Using a thermal imaging camera, the heat generated during the machining of a hole in Al-alloy AlSi7 was taken in real time and documented. The sheets applied for the test had a thickness of 14.00 mm and were drilled on the face so that the remaining residual wall between the hole and thermo-graphic examination of the sheet surface was 2.00 mm. Using the above test layout it was possible to make a qualitative analysis of the heat generated by the individual tools.

The thermal imaging of the tool point show a clear connection between the rake angle and the heat generated. A positive rake angle resulted in a clearly lower temperature being generated in the shear zone of the chip, because with a tool with a 30° helix the chip only requires deflecting by 60° (reduced shearing action), whilst the chip deflection for a straight-fluted tool is 90° (increased shearing action).

The heat generated in the shear zone directly enters the process as cutting heat. A shorter chip transfers less frictional heat to the tool due to a smaller contact area on the flute surface resulting in improved temperature conditions

In addition, the chipflow was recorded using a high-speed camera. With the cutting parameters v_c = 300 m/min and f = 0.35 mm/rev., distinct differences were apparent regarding the chip evacuation and the process heat. Chip evacuation, i.e. the continuous transportation of chips from the hole, improved when the helix angle of the tool was increased.

This is primarily due to a positive geometry and the resulting improved chip fracture, providing a shorter shearing chip that, due to its improved surface-volume-relationship, can be evacuated from the hole with greater ease and is less prone to jamming in the flute.

Thanks to considerably improved chip evacuation and comparatively lower process temperatures, spiral-fluted tools play an important role in the increased process reliability in dry machining and MQL applications.

However, the application of straight-fluted drills can be of advantage for the machining of aluminium and cast iron materials, where the demand for hole quality (improved roundness and reduced run-out) is high. This is because straight-fluted tools generally possess four leading margins. In addition, the temperature profile of straight-fluted drilling tools can be reduced by an optimized, geometric design of the coolant ducts to an extent that the thermal disadvantage in comparison to spiral drilling tools is compensated to a large degree.

Dry machining and minimal quantity lubrication (MQL)

Influence of friction on the process temperature

In an additional, three-part test, holes were produced in spheroidal graphite iron GGG40. An identical test tool was applied for completely dry machining, MQL machining and machining with air cooling.

The test tool was a diameter 8.5 mm drill, optimized for MQL. The drilling depth was 42.00 mm. The cutting rates were $v_c = 130$ m/min and $f = 0.26$ mm/rev.

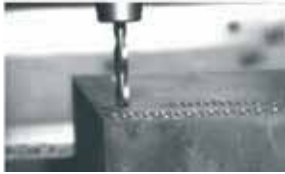

A thermo-graphic camera recorded the temperature at the point during the return stroke from the hole. A machining sequence of seven consecutive drilling operations was recorded for this purpose. From the first to the fifth hole a temperature increase at the point was recorded, however, following the fifth hole the maximum temperature at the point during the withdrawal process did not change (quasi stationary condition). For this reason the temperature of the drill was always recorded following the seventh hole.

Consequently, this temperature is lower than that occurring at the point of the drill during the cutting process. Measuring with thermal elements below the face and just behind the cutting lip have shown that temperatures up to 900° C can occur in this area. However, the temperature comparison carried out in this test is admissible because the measurement was always taken at the same point in time.

WITHOUT

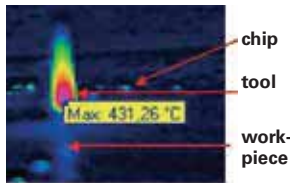

During a completely dry application, the temperature at the point of the drill reached a maximum 431° C. This temperature does not pose a particular problem for modern tool materials and hard coatings, even a completely dry

application offers process reliability.

However, the diffusion and adhesion wear mechanisms both accelerate at higher temperature levels, which in turn reduces tool life. Furthermore, an increased level of heat can lead to a thermal expansion of the work piece, that in turn can jeopardise the close tolerance dimensions if the

suitability of the machining strategy is not observed. In addition, with steel machining it can come to fringe zone hardening of the hole wall, making follow-up operations such as tapping or reaming more difficult.

AIR

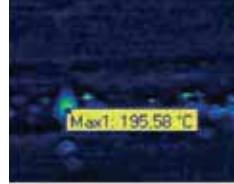

In the second test, the heat measured at the point of the drill with internal air cooling was 196° C, evidence that the flow of air dissipates a considerable amount of the generated heat. In addition, chip evacuation was considerably improved, confirming that in contrast to completely dry machining the spiral flute of a drilling tool alone is not sufficient for an optimal chip evacuation.

MQL

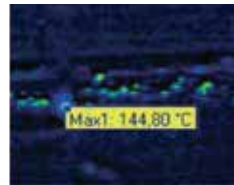

Under similar test conditions, the heat measured at the point of the drill applied with MQL, i.e. air mixed with small quantities of oil, was only 145° C. An oil volume of only 30 ml/h could not be regarded a major contributing factor in the cooling process, therefore, it must be presumed that the small quantities of oil mixed with air caused a considerable reduction in friction. It also confirms, in contrast to pure air cooling, a further increase in speed of chip evacuation. The lower chip temperature, in comparison to pure air cooling, is further clear evidence of oil reaching the effective area and improving chip evacuation from the face thanks to improved friction characteristics.

Dry machining

Dry machining dispenses with the use of coolant entirely resulting in savings in various areas. For example, less expensive tools without internal coolant ducts can be applied. Furthermore, machines and tool holders suffice without elaborate coolant delivery techniques and obviously there are no longer the costs of coolant and their disposal. Coolant does not have to be removed from components and the surrounding machine area.

Without lubrication, the heat generated during the machining process must be kept to a minimum and dissipated solely via the chip. Otherwise, tool and work piece are exposed to excessive heat, resulting in increased wear to the tool and hardening of the hole surface in the work piece. Suitable coatings can prevent overheating of the tool. However, excessive heat to the work piece can only be achieved by a

good chip evacuation, whereby the tool geometry also plays an important role. Short chips, large flutes with polished surfaces – possibly MolyGlide-coated – can provide the solution.

In a few dry machining applications, air is used for cooling. Obviously, tools with coolant ducts are applied, through which air is delivered to the hole. Air not only cools tool and work piece, but under the correct pressure also improves chip evacuation.

Interestingly, dry and HSC machining do not exclude one another, as one would expect. On the contrary, modern carbide drills and coatings allow so-called dry HSC – dry high speed machining, combining the advantages of the two machining trends, as for example, a reduction in production costs in certain applications.

Minimal quantity lubrication MQL

MQL or minimal quantity lubrication works with an air-lubricant-mixture, that only contains a small part of lubricant.

In the past, the technology of minimal quantity lubrication was generally applied on the own initiative of the user, in order to reduce costs. Often, tools for wet machining were simply applied under MQL conditions. With this approach, the limits of the tools' efficiency were reached very quickly and it became clear that a mere substitution of the lubricant was not a targeted approach.

A professional approach during the design of MQL suitable tools nowadays allows considerable performance increases whilst maintaining process reliability. Hereby, all the drill's relevant attributes for providing efficiency and process reliability, from the cutting edge to the flute as well as the shank end, are adapted to satisfy the special demands of MQL. As well as the choice of carbide, this also includes the special tool geometry, the tool coating and the design of the shank end for MQL drills.

To optimize drills for the MQL technology, Guhring is increasingly applying the Finite-Element-Method (FEM). FEM allows the dimensioning and optimization of the tools during the design phase. The flute in the area directly behind the cutting edge has the task to mould the chip in order to break it as small as possible. In the rear area its task is to evacuate the chip as quickly as possible. These tasks apply to wet machining, minimal quantity lubrication as well as dry machining. With minimal quantity lubrication and dry machining, however, it is extremely important to provide the chip with minimal frictional resistance in the rear area, in order to ensure a problem-free chip evacuation. This is aided by an optimized flute form as well as a specially polished flute surface.

Flute design to suit MQL

With the assistance of the aforementioned FEM-analysis, it is possible to simulate the flow resistance of a flute with chip, subsequently providing optimized flute forms for different material classes. The following image shows a flow optimized flute form and point design, providing optimal chip flow and also minimizing the thermal load of the cutting edge thanks to an optimized through flow of the point area and the flute by the MQL aerosol.

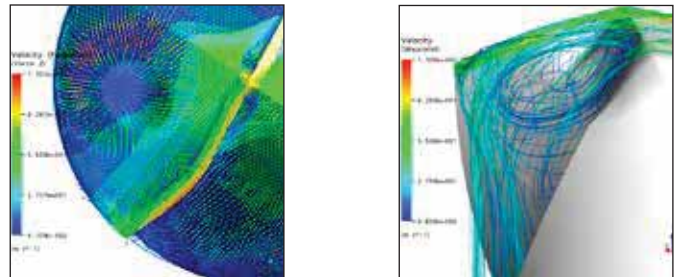

In addition, improved chip evacuation and therefore increased process reliability is provided by a MQL-suitable coating. Guhring has developed a double coating, consisting of a hard coating with an additional soft coating, MolyGlide. Tests confirm a considerably higher chip evacuation speed for the MQL tool with the above coating in comparison with conventional tools.

Coolant delivery to suit MQL

Because an extremely low volume of lubricant is applied with minimal quantity lubrication, the delivery of these low coolant quantities to the effective area is of utmost importance. Hereby, the geometric design of the shank end is of main significance for a safe delivery of the lubricant.

Dry machining and minimal quantity lubrication (MQL)

In order to satisfy the demand for more efficiency and process reliability with MQL drilling operations, Guhring has examined the design of the shank end and subsequently the coolant delivery in great detail.

Due to the low volumes of coolant involved, it is important that four basic demands are met in the design stage.

- minimal dead areas that could lead to consolidation of coolant
- sealed coolant transfer surface between shank end and delivery screw preventing the escape of coolant in the clamping area of the chuck or in the internal areas of HSK (preventing swarf deposits that could lead to concentricity errors following the next tool change).
- simple handling
- cost-effective production

The technologies applied in the design solution of a MQL suitable shank end are based on spray tests as well as computer based simulation programs. CAD-CFD combination has proved to be an especially effective technology. CFD (Computational Fluid Dynamics) assists in determining flow fields. The final choice of suitable shank end is confirmed by spray tests.

Via CAD-CFD and spray tests Guhring has examined four different shank ends and the corresponding adjustment screws regarding their efficiency:



1. Plain shank end without groove with plain screw (left)
2. Plain shank end with sickle-shaped groove to connect the two coolant ducts with plain screw (second from left).
3. Conical shank end with circular groove and taper screw (second from right)
4. Recessed shank end (labyrinth seal) without connection groove with corresponding screw (including indexing facility for orientation of coolant ducts, right)

In intermittent spray tests the different shank ends were examined regarding coolant consolidation in the clamping area of the tool shank and inside the HSK. A test period of one hour with intervals of 5 seconds spraying with a spindle speed of 10,000 rev./min and 2 seconds dry running with

a stationary spindle provided the following results for the four examined shank ends:

re.: 1. and 2.: Heavy oil contamination in clamping area and inside HSK.

re.: 3. and 4.: No oil contamination in clamping area and inside HSK

The conical shank end and the shank end with labyrinth seal proved to possess optimal sealing characteristics.

In a second test, the various shank ends were examined regarding response time and the conveyed volume accuracy of the transferred cooling agent. A slotted pipe was fitted at an angle into the working area of the machine tool. The tool was inserted into the slot. During a Z/Y travel sequence the MQL delivery was switched on and off. The internal area of the pipe was fitted with blotting paper to collect the flow of coolant. The blotting paper was then removed to examine the spray pattern.

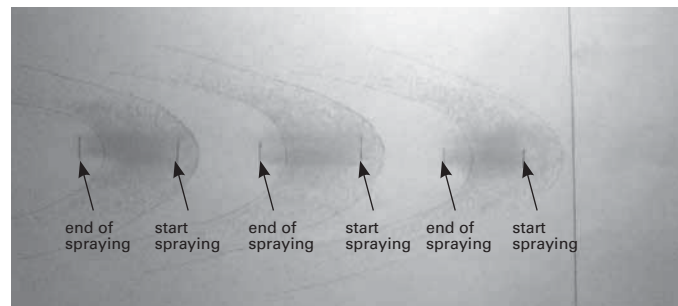

Layed flat, the blotting paper shows a geometry dependent parabolic spray pattern. By analyzing the spray pattern at the beginning and at the end of the test whilst simultaneously observing the axis stabilization signal for the machine tool axes it is possible to calculate the reaction time of the various shank end design solutions.

There are clear differences dependent on the shank end design. Furthermore, through the spray volume shown in a broader spray pattern, it is possible to deduce the conveyed volume during the spray period.

By the way, with Guhring's new measuring instrument MQL-Check 3000 it is possible to evaluate the MQL aerosol flow characteristics of tools quantitatively and time-resolved. The measuring instrument provides the user with reliable data to adapt the air pressure and the lubricant content of the MQL aerosol to the process.

Both findings (spray pattern and reaction time) show the conical shank end and the shank end with labyrinth seal to be superior to those with plain shank end. Subsequently, only the conical shank end and the shank end with labyrinth seal were deemed suitable for further examination and optimization.

Because a vector analysis is carried out for the flow, it is possible to analyze the flow pattern according to the direction of flow. Hereby, the speed vectors are examined for forward and reverse flow. Any turbulence formation has a forward and reverse flow. Often, turbulence occurs in dead areas. At this point totally opposing statements can be made for single and two coolant duct systems.

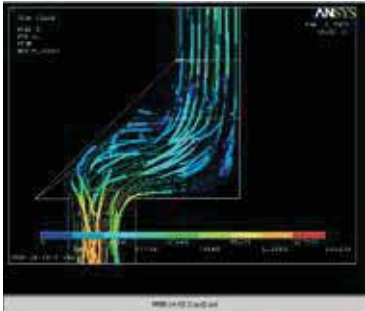

With the assistance of a CFD analysis, the form and size of the connection slot at the shank end were examined. The picture on the left shows the flow profile within the connection shank end – adjustment screw for a conical shank end. Various slot forms were analyzed.

Whilst dead areas in single coolant duct systems lead the medium to be deposited on the wall and separating thanks to the flow speed within the turbulence, dead areas in two coolant duct systems are areas requiring to be filled before the medium can continue. Based on the produced flow patterns, conical shank end B with wide connection slot and rounded base proved to be the optimal solution.

An analysis of the two requirements “simple handling” and “cost-effective production” painted a similar picture. The following table shows the respective evaluation, whereby the data refers to the shank end and the corresponding screw. Relevant features for process reliability, such as “minimal dead areas” and being “leakproof” provide criteria for excluding the two versions with plain shank ends. Subsequently, the most favoured shank end is the one with a conical end and a wide slot with rounded base.

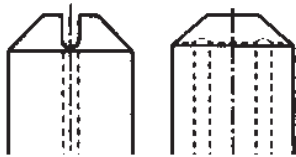

A: Narrow slot with rounded base

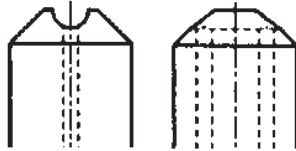

B: Wide slot with rounded base

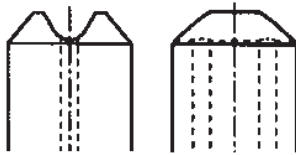

C: Wide slot with round-convex base

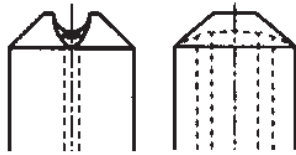

D: Wide slot with convex base

Spray patterns were also produced for the above slot forms, showing a tendency to solution B. However, the variations were marginal but the CFD analysis showed a clearer picture.

Shank end	Handling	Cost-effective production	Minimal dead areas geom. analysis	Leak-proof
Plain w/o slot	++	++	-	-
Plain w. sickle-shaped slot	++	+	-	-
Conical with slot	++	+	+	++
Recessed end with labyrinth seal	-	-	++	++

++ = very good properties, + = good properties, - = poor properties

The Guhring MQL system

A further decisive criteria for the process reliability of MQL tools is a problem-free system assembly. Guhring's solution is a recently developed MQL delivery system consisting of a one-piece delivery pipe with a thin-walled stainless steel pipe glued inside and a MQL adjustment screw.

The MQL pipe installed in conventional MQL systems is not optimally suited for a process reliable installation due to its high flexibility and its low thermal resistance. Therefore, Guhring uses a stainless steel pipe, eliminating the disadvantages mentioned above. Its large internal diameter also ensures improved flow conditions. The necessary radial flexibility of the coolant delivery pipe installed in the chuck is ensured because it is not glued along its entire length, only a few millimetres of its axial length at the base. Following the glued area, the bore is enlarged so that the coolant delivery pipe has radial flexibility. In addition, Guhring's MQL system provides access and also its axial adjustment at the shank end via hexagon screw.

Guhring has perfected every proposed design feature for an optimum MQL delivery including the design of MQL specific tools for its entire program ensuring the possibility of process reliable MQL operations with solid carbide tools. In addition, our GM300 program includes tool holders, clamping systems and accessories that are specifically designed to satisfy the requirements of MQL machining.

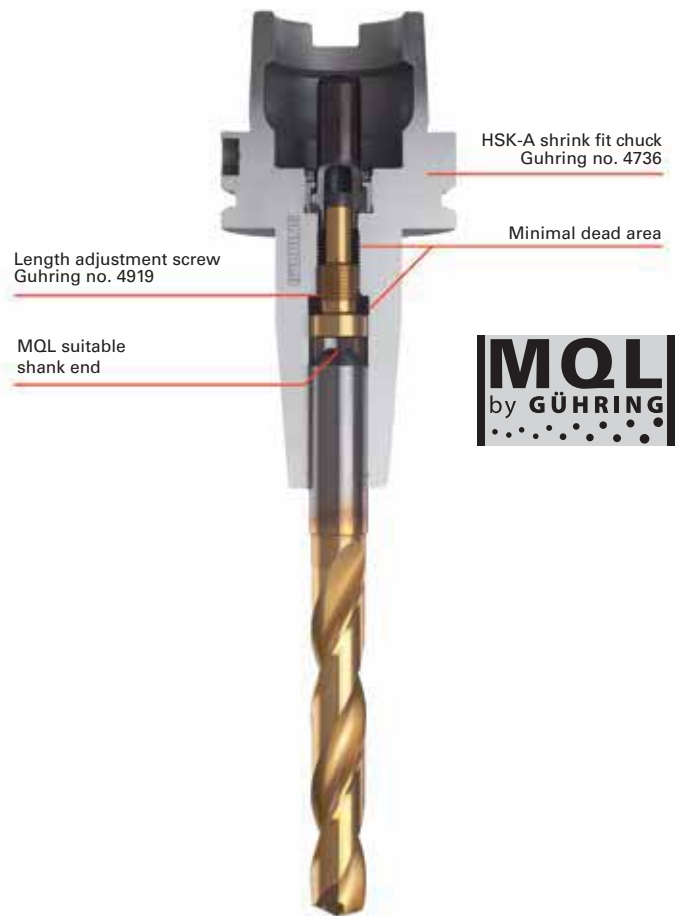



SPECIAL DRILLS

Although we probably offer the most comprehensive standard tool range, there are still applications that require special solutions.

Customer specific special solutions are therefore also part of the Guhring program.

Put us to the test with your special requirements – thanks to our know-how regarding geometries, tool materials and coatings we will surely convince you!

Special point geometry and manufacturing tolerances

Special point geometry to DIN 1412 (extract; edition 03/01)

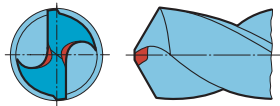

Form A
Thinned
chisel edge

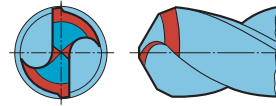

Form D
Point ground
for cast iron

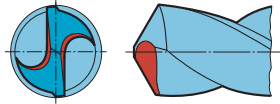

Form B
Thinned chisel edge with
corrected
cutting lips

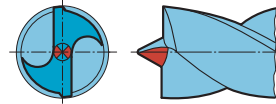

Form E
Brad point
(center point)

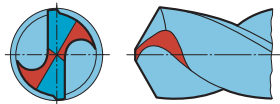

Form C
Split point

Twist drill manufacturing tolerances to DIN ISO 286, part 2

diameter (nominal size) up to and incl. mm	tolerance range mm	
	h8	h7
0.38 ... 0.60	10	7
0.95	12	8
3.00	14	10
6.00	18	12
10.00	22	15
18.00	27	18
30.00	33	21
50.00	39	25
80.00	46	30
120.00	54	35

* If you need tolerances other than ISO h8 please let us know. Additional charges for closer diameter tolerance see additional charges at the end of chapter Drilling Tools.

Reference to other relevant standards

- DIN 228 Part 1 machine tapers; Morse tapers and metric tapers, taper shank
- DIN 1414-1 Directions for design and use for high speed steel twist drills
- DIN 6580 Definitions of the metal-cutting industry; motions and geometry of the cutting process
- DIN 6581 Definitions of the metal-cutting industry; Cutting portion reference systems and angles

The standard descriptions above are given with the permission from the German Standards Institute (Deutsches Institut für Normung). The most recent editions of the standard sheets apply and are available in DIN A 4 format from Beuth-Verlag GmbH, D-10787 Berlin.

HSS & HSCO specials production range options

Substrate HSS and HSCO (M2, M35, M42) and Other Materials on request
 Solid and Coolant-Through

Flute Style Normal, High Helix, Low Helix, GT 100, GT 80, GT 50, Chipbreaker and Other Special Forms

Margin Single, Double, Triple, Full Cylindrical

Helix Angle 0° to 52°

Cutting Direction Right Hand or Left Hand

Reamers available in Left Hand Flute, Right Hand Cut, Equal or Unequal Flute Space

No.	Tool Description	Diameter		Overall length		Flute length	
		Inches	mm	Inches	mm	Inches	mm
01	Drills	$3/64 - 3/4$	1,00 - 19,05	$37 \frac{1}{2}$	950	$31 \frac{1}{2}$	800
		$> 3/4 - 1 \frac{1}{2}$	$> 19,05 - 40,00$	$37 \frac{1}{2}$	950	$31 \frac{1}{2}$	800
02	Three- & Four-Flute Drills	$3/64 - 3/4$	1,00 - 19,05	$37 \frac{1}{2}$	950	$31 \frac{1}{2}$	800
		$> 3/4 - 1 \frac{1}{2}$	$> 19,05 - 40,00$	$37 \frac{1}{2}$	950	$31 \frac{1}{2}$	800
03	Step Drills						
04	Step Drill Reamers						
05	Step Core Drills						
06	Step Core Drill Reamers	$3/32 - 1 \frac{9}{16}$	2,38 - 40,00	$27 \frac{3}{4}$	710	$24 \frac{1}{2}$	620
07	Reamers						
08	Step Reamers						
10	Subland Drills						
11	Subland Drill Reamers	$1/8 - 1 \frac{1}{2}$	3,175 - 40,00	$27 \frac{3}{4}$	710	$19 \frac{3}{4}$	500
12	Subland Core Drills						

Table for General Guidance only. Contact a GUHRING Territory Manager to confirm specifications and availability.

Carbide specials production range options

Substrate Carbide (P40, K10/K20, K40) and Other Materials on request
 Solid, Coolant-Through and 2-Piece Construction

Flute Style Normal, High Helix, Low Helix, GT 100, GT 80, GT 50, RT 100, RT 150 (Straight), RT 80, GS 200 (Three) and Other Special Forms

Margin Single, Double, Full Cylindrical

Helix Angle 0° to 45°

Cutting Direction Right Hand or Left Hand

Reamers available in Left Hand Flute, Right Hand Cut, Equal or Unequal Flute Space

No.	Tool Description	Diameter		Overall length		Flute length	
		Inches	mm	Inches	mm	Inches	mm
01	Drills	$5/64 - 51/64$	2,00 - 20,00	$17 \frac{11}{16}$	450	$15 \frac{23}{32}$	400
		$> 51/64 - 1$	$> 20,00 - 25,40$	$15 \frac{23}{32}$	400	$13 \frac{49}{64}$	350
02	Three- & Four-Flute Drills	$1/8 - 51/64$	3,175 - 20,00	$37 \frac{1}{2}$	450	$31 \frac{1}{2}$	400
		$> 51/64 - 1$	$> 20,00 - 25,40$	$15 \frac{23}{32}$	400	$13 \frac{49}{64}$	350
03	Step Drills						
04	Step Drill Reamers						
05	Step Core Drills	$3/32 - 51/64$	2,38 - 20,00	$17 \frac{11}{16}$	450	$15 \frac{23}{32}$	400
06	Step Core Drill Reamers	$> 51/64 - 1$	$> 20,00 - 25,40$	$15 \frac{23}{32}$	400	$13 \frac{49}{64}$	350
07	Reamers						
08	Step Reamers						
10	Subland Drills						
11	Subland Drill Reamers	$1/8 - 51/64$	3,175 - 20,00	$37 \frac{1}{2}$	450	$31 \frac{1}{2}$	400
12	Subland Core Drills	$> 51/64 - 1$	$> 20,00 - 25,40$	$15 \frac{23}{32}$	400	$13 \frac{49}{64}$	350
	Gun Drills, Routers, End Mills, Diamond Inserts/Tooling	On request		On request		On request	

Table for General Guidance only. Contact a GUHRING Territory Manager to confirm specifications and availability.

Quote Request Form



Date Received: _____ Quote #: _____ Date Due #: _____

Distributor: _____ Enduser: _____

Attn: _____

RFQ #: _____ Attn: _____

Tool #: _____ Quantity: _____

Tool Description: _____

_____ MT #: _____ Tang: Yes No

Nominal Diam.	Overall Length	Flute Length	Shank Diam.	Point
Step _____	Length _____	Angle _____		Meas _____
Step _____	Length _____	Angle _____		Meas _____
Step _____	Length _____	Angle _____		Meas _____
Step _____	Length _____	Angle _____		Meas _____

Material to Cut: _____

Hardness (Rc or Bhn): _____

Condition: _____

Hole Diameter: _____

Hole Tolerance: _____

Depth of Cut: _____

Location Tolerance: _____

Straightness: _____

Hole Finish: _____

Hole Type:

- Drill
- Drill-Countersink
- Drill-Ream
- Core
- Drill-Bore
- Other _____
- Ream
- Drill-Drill

Bushing: Yes No

Hole description: Blind Through Pre-drilled
 Interrupted Cast hole

Approach: Horizontal Vertical

Other: _____

Rigid Setup: Yes No Somewhat

Turning: Tool Part Both

Coolant: Flood Through-the-spindle None

Flexible S & F: Yes No

Limits: _____

Comments: _____



Versatile

For deep holes from \varnothing 0.9 to 40.00 mm
up to max. 3000 mm overall length



EB 800

EB 80

ZB 80

EB 100

GUN DRILLS



GUHRING

A brief introduction to the subject of deep hole gun drilling

In the machining world, drilling depths of $10 \times D$ and deeper are regarded as deep hole drilling operations, whereby smaller drilling depths can naturally also be produced with gun drills. Advantage is taken of the positive side effects, as for example good surface quality, low deviation from concentricity and optimized alignment accuracy.

High pressure cooling - has become a matter of course.

In recent years, internal cooling has established itself for all drilling tools. Coolants are now living up to their name and being supplied via coolant ducts to where they are urgently required. Considerable improvements in tool life and less breakages have been achieved by this measure for twist drills, taps etc.

Every conventional machine tool currently on the market can be supplied with high pressure internal cooling and is therefore also suitable for deep hole drilling.

The share of gun drills on machining centres, lathes etc. is forever gaining more importance. The process is therefore increasing in popularity in the machining world.

Typical procedure with all gun drills on conventional machine tools:

- production of pilot hole (tol. H8). Enter at low revolutions, approx. 200 rev./min, feed rate approx. 500 mm/min.
- setting coolant pressure and speed.
- continuous drilling to complete hole depth without wood pecking.
- switch off coolant supply after reaching hole depth.
- rapid withdrawal with stationary spindle.

Application advice

- For drilling depths in excess than $40 \times D$ we recommend the use of two or more gun drills, e. g. $\varnothing 10 \times 400$ mm and $\varnothing 9.95 \times 800$ mm.
- Gun drills for drilling depths of more than $40 \times D$ should enter the pilot hole revolving in the left hand direction.
- For machining of long-chipping materials we recommend the use of gun drills with polished flutes.
- Single-fluted gun drills for long-chipping aluminium should be supplied with point grind 180° and coolant chamber.
- Generally we recommend the use of soluble oil with a minimum oil content of 10 %.



All gun drills must have support for the pilot hole.

Gun drills must never operate at full speed without support in the machine shop.

Deep hole drilling is not a closed book, but can be mastered by anybody as long as certain conditions are adhered to.

Recommended cutting rates for the application of Guhring gun drills can be found on the pages for the individual types!

Deep hole drilling on conventional machine tools

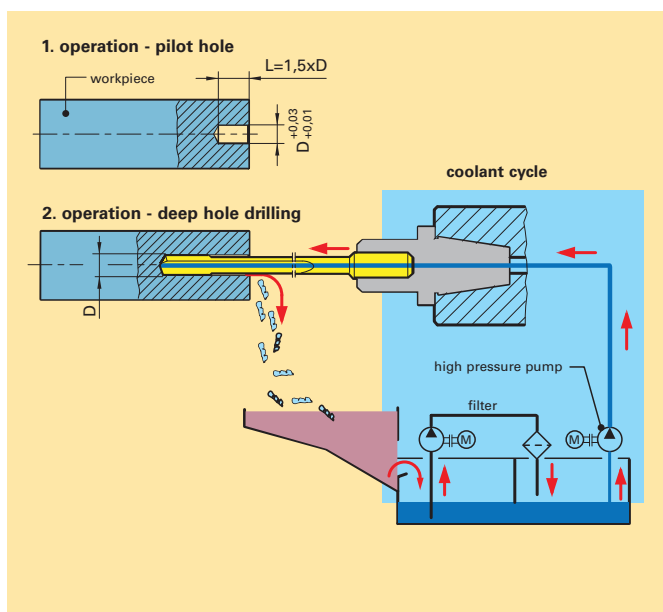

Deep hole drilling machines

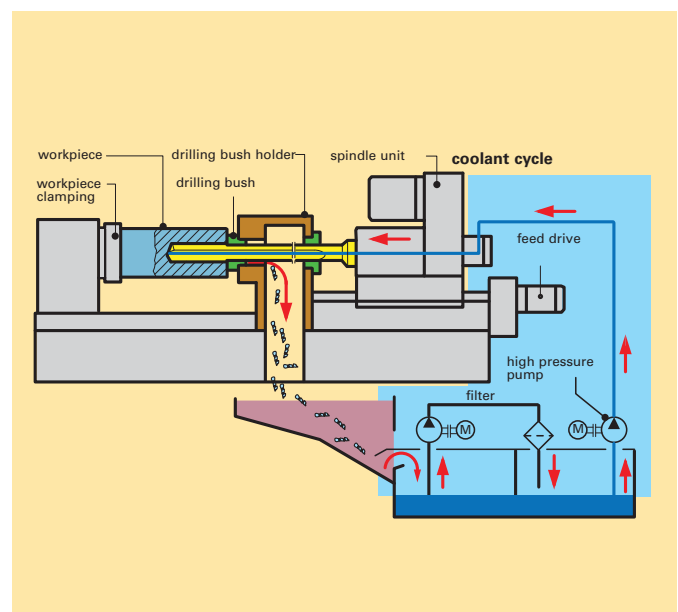

Basic tolerances

The application of single-fluted gun drills can achieve a lower basic tolerance, as the cutting forces at the cutting edge are absorbed by the supporting strips, unlike twist drills where the slightest deviation of the two cutting edges causes a larger hole.

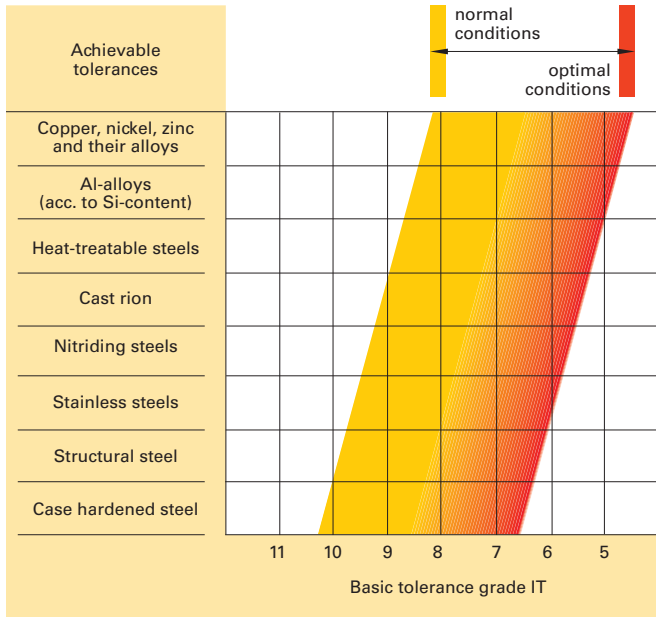

Alignment accuracy

Because brazed single-fluted gun drills always have the precision carbide head brazed on to a flexible tube, the tool achieves very accurate aligned holes remaining unaffected by possible concentricity errors.

However, extreme material fluctuations and other influencing factors can impair the alignment accuracy.

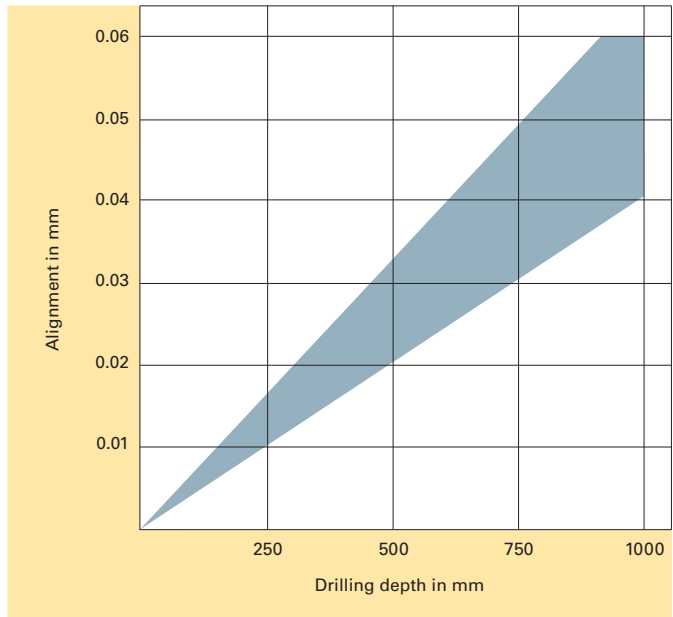

Surface quality

The forces at the cutting edge are absorbed by the support bushes, which in return burnishes the surface. Lubrication between the supporting strips and hole surface is therefore very important. The better the lubricant, the better the surface quality.

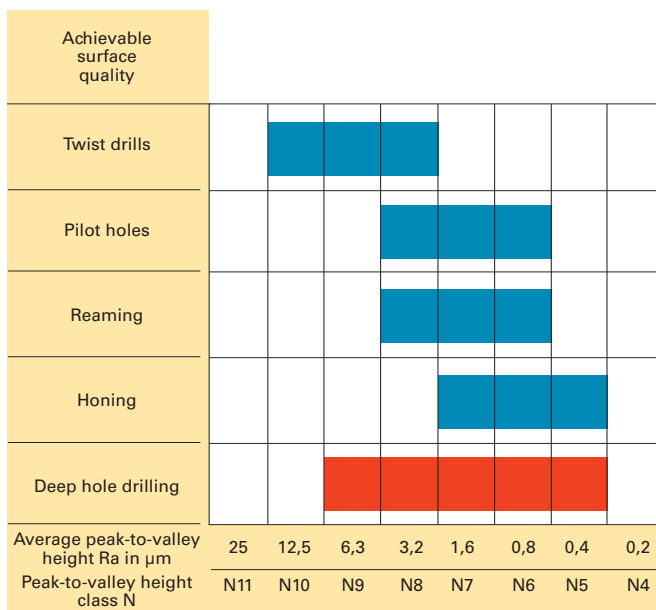

Deviation from concentricity

When a hole is produced with, for example, a commercial twist drill, the quality of the point grind affects the concentricity of the hole. An imbalance of forces is created at the cutting edges. With gun drills, these cutting forces are absorbed by the supporting strips, resulting in excellent concentricity.

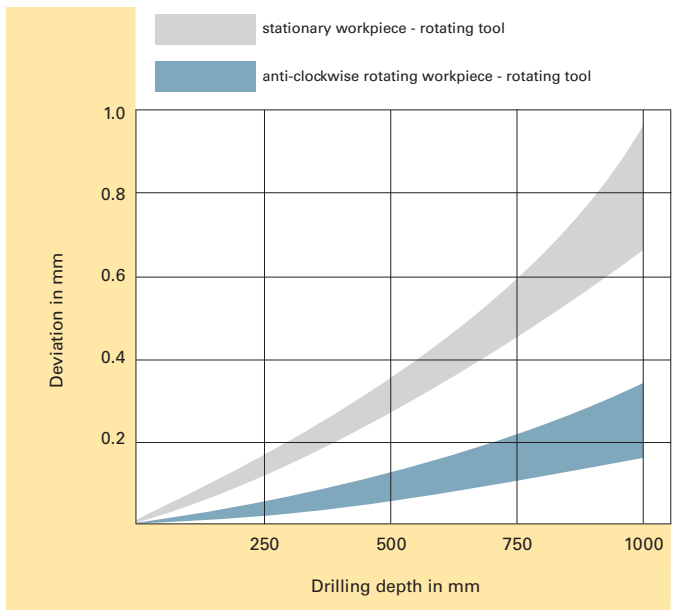

Technical



suitable for almost every material, from Ø 1.0 - 8.0 mm, max. flute length 300 mm



For certain materials a coating is required, as the successful application of gun drills with a bright surface finish cannot be guaranteed. For coating definitions see GühringNavigator.

- S TiN-coat
- F FIRE
- M MolyGlide
- A SuperA

The dimensions required to calculate the length for conventional machine tools

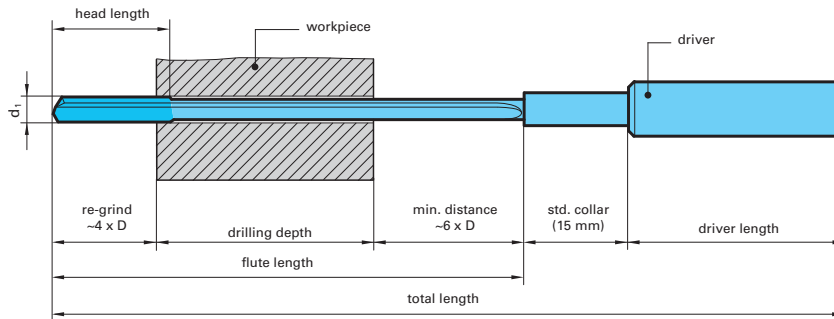

EB 100 Head forms

(Position of supporting strips. Special head forms on request.)

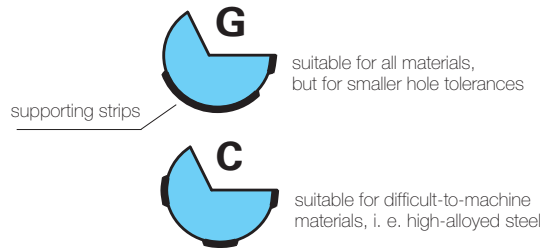

EB 100 Standard point grinds

(special point grinds on request)

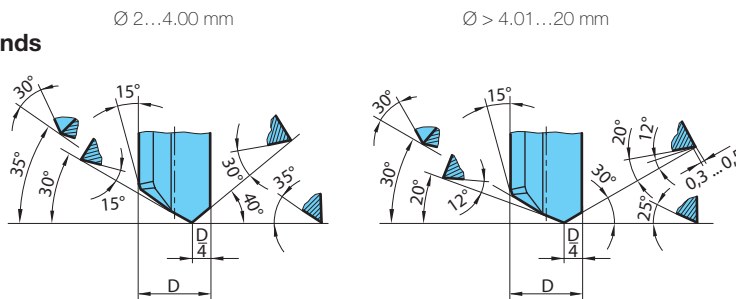

EB 100 Back taper ratio

(dimensions in mm)

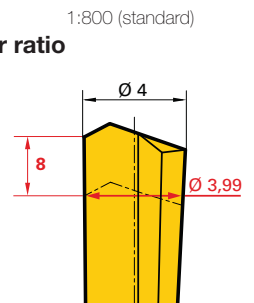



To ensure EB 100 is designed and produced specifically for your application, please complete the questionnaire and use for your inquiry/order.

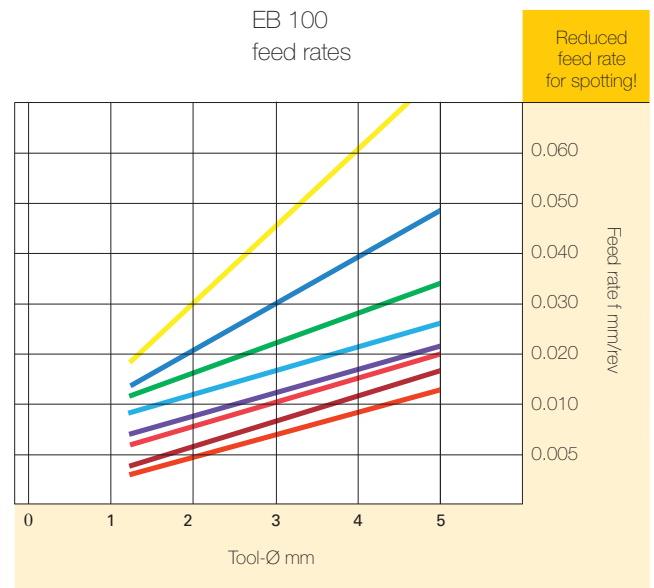
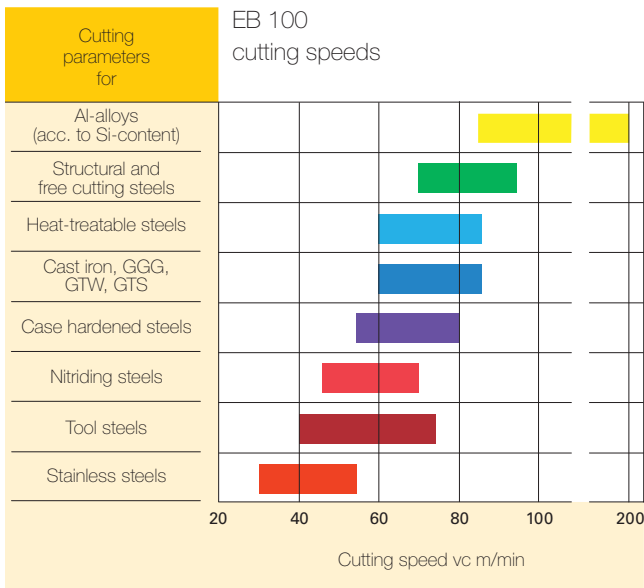

(Detailed cutting parameters see GuhringNavigator)

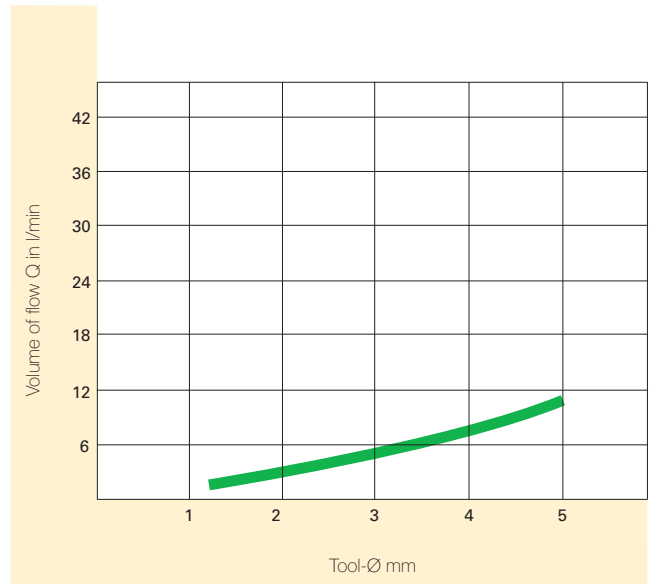
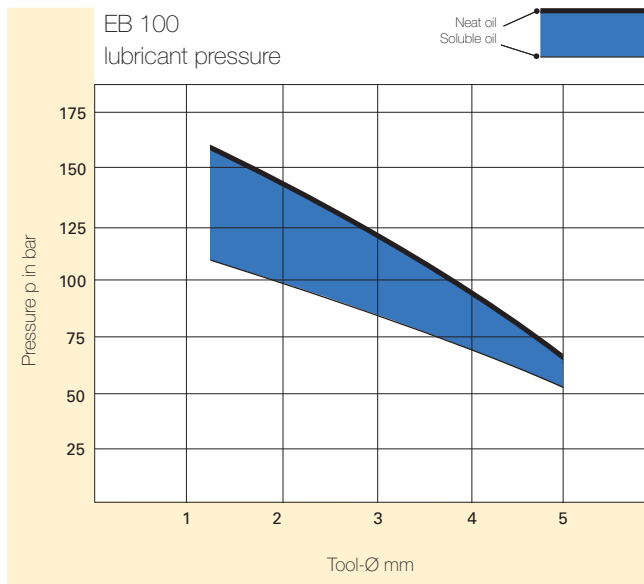

Technical

**suitable for almost every material, from Ø 2 - 40.0 mm,
max. total length 3000 mm**



For certain materials a coating is required, as the successful application of gun drills with a bright surface finish cannot be guaranteed. For coating definitions see GuhringNavigator.

- S TIN-coat
- F FIRE
- M MolyGlide
- C TiCN

**The dimensions required to calculate the length
for conventional machine tools**

* max. flute length per tool
40 x D, for larger drilling depths
apply two tools. (i.e. Ø 10 x 450
and Ø 9.95 x 850 mm)

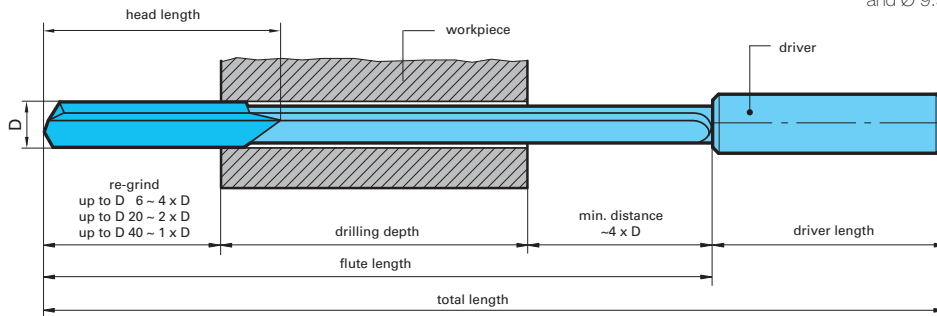

**EB 80
Head forms**
(position of
supporting strips)

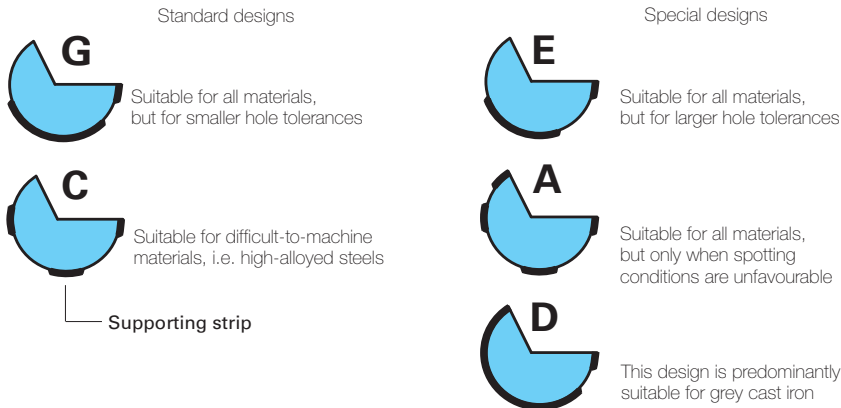

**EB 80
Standard point grinds**

(special point grinds available)

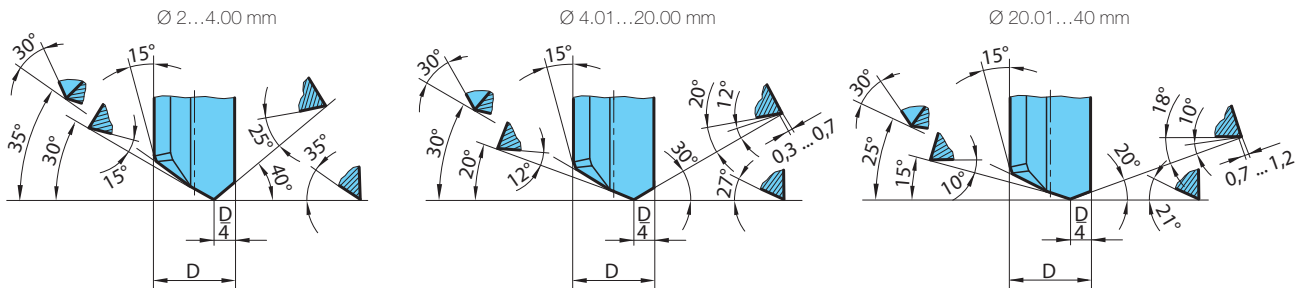

To ensure EB 80 is designed and produced specifically for your application, please complete the questionnaire and use for your inquiry/order. From Ø 6.0...20.0 mm we can fit PCD or CBN cutting edges on request. With AISi-alloys for example, tool life subsequently increases multi-fold.

Fast service for brazed single-fluted gun drills

In addition to the ex-stock range Guhring offers a fast service for gun drills with standard point grind and standard driver in the following dimensions. Delivery time is max. 3 weeks.

nom.-Ø-mm	in increments of mm	head form	total length	Prices on request
2.00...13.90	0.1	G	≤ 7.5 mm Ø 650 max	
4.00...13.90	0.1	C	> 7.5 mm Ø 1000 max	
14.00...22.00	0.5	G	1000 max	
14.00...22.00	0.5	C	1000 max	

Tool material:	solid carbide/K15			
Surface finish:	○			
Standard head lengths (mm)	Ø-range	length	Ø-range	length
	2.00...2.49	15	10.00...10.99	35
	2.50...2.99	18	11.00...17.00	40
	3.00...3.99	20	17.01...20.00	45
	4.00...5.19	25	20.01...23.00	50
	5.20...6.99	30	23.01...26.00	55
	7.00...9.99	35	26.01...40.00	65
Flute length:	min. 20 x D			

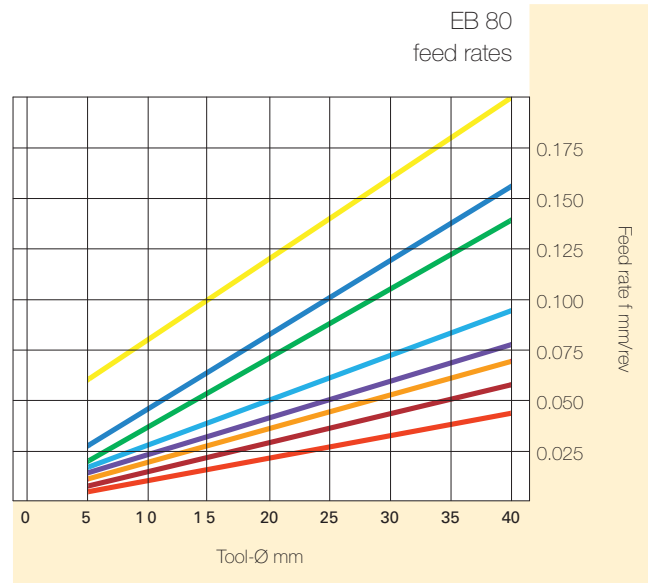
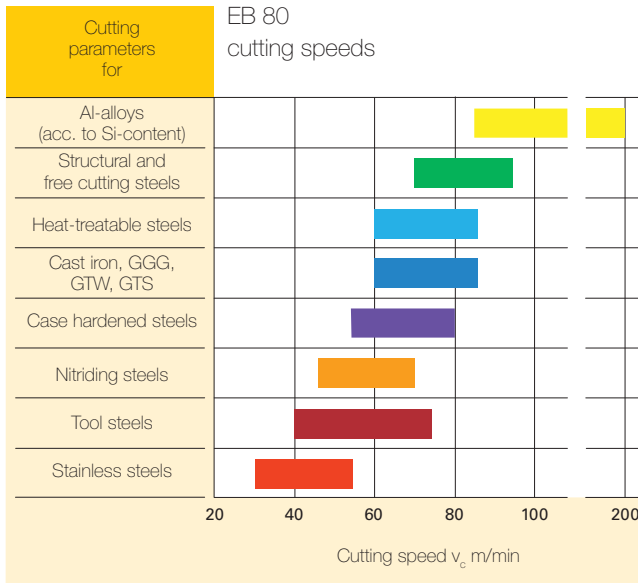

(Detailed cutting parameters see GuhringNavigator)

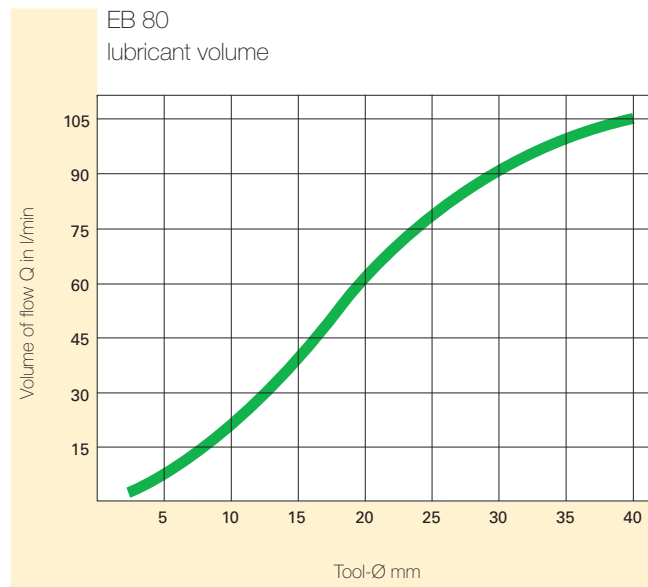
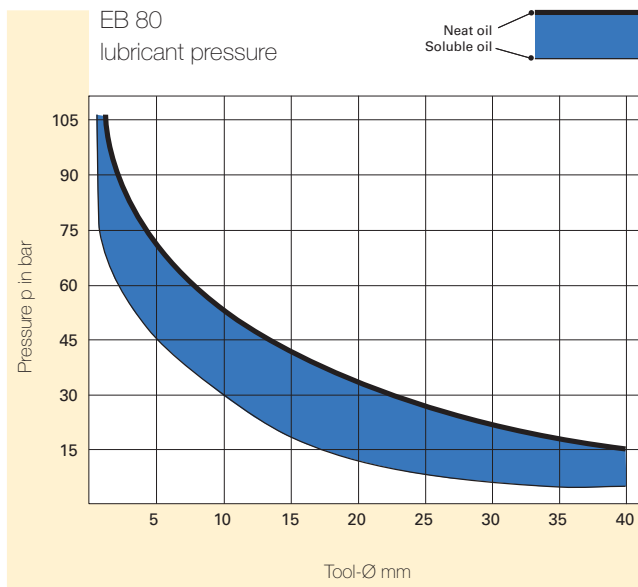

Technical

suitable for cast iron, aluminium and short-chipping non-ferrous metals, from Ø 6.0 - 27.0 mm, max. total length 1000 mm

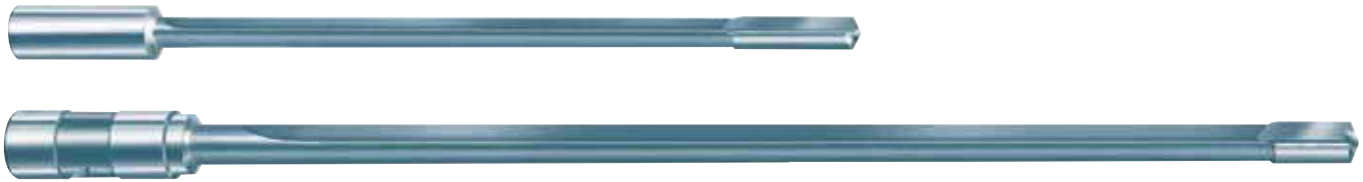

M MolyGlide

For certain materials a coating is required, as the successful application of gun drills with a bright surface finish cannot be guaranteed. For chilled cast iron and Al cast alloys with a Si-content above 10% we recommend our MolyGlide-coating. However, two-fluted gun drills type ZB80 can only be coated with MolyGlide up to an overall length of maximum 500 mm due to the technical production process. See also the GuhringNavigator.

The main advantage of two-fluted gun drills compared to single-fluted gun drills is the substantially higher feed rate that can be applied during the production of the hole. This is due to the design of the two-fluted gun drill, it has two cutting edges and two flutes. Holes can therefore be produced considerably faster. However, this increase in machining speed is combined with a reduction in hole accuracy. This is also a direct consequence of a drill design with two cutting edges. As the cutting edges are

positioned opposite each other, there is less of a smoothing effect and less support in comparison to a single-fluted gun drill. For drilling depths $\leq 10 \times D$ we recommend our Ratio drill RT 150 GG, available ex stock and more cost-effective for these drilling depths than brazed gun drills. In addition, RT 150 GG does not require a pilot hole in most applications.

The dimensions required to calculate the length for conventional machine tools

* max. flute length per tool $40 \times D$, for larger drilling depths apply two tools, (i.e. $\text{Ø } 10 \times 450$ and $\text{Ø } 9.95 \times 850$ mm)

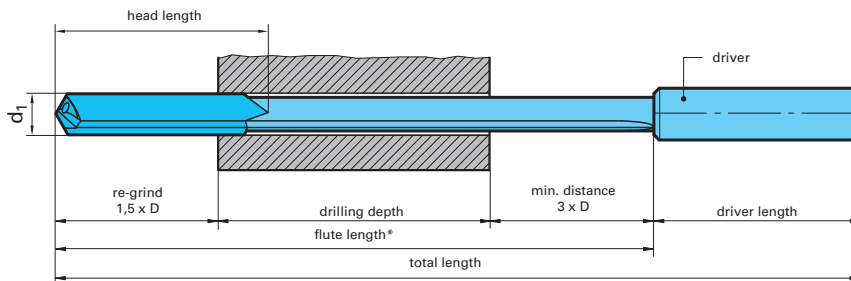

Technical

ZB 80 Standard point grinds

(special point grinds available)

Point grind G for machining cast iron

Point grind A for machining aluminium

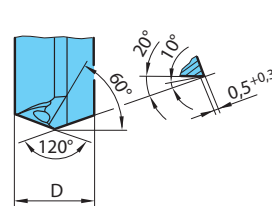
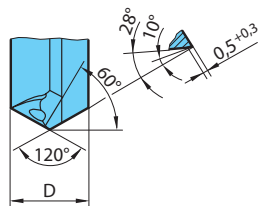

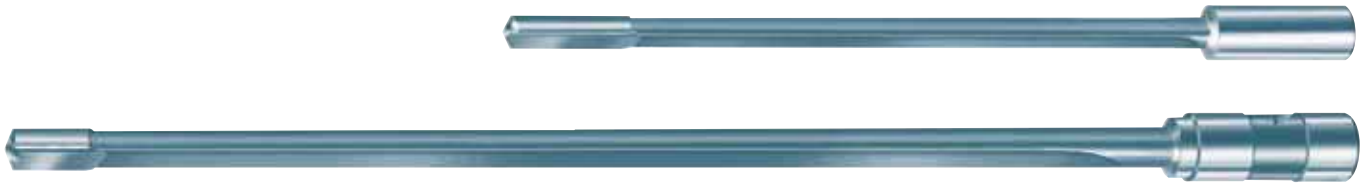

To ensure ZB 80 is designed and produced specifically for your application, please complete the questionnaire and use for your inquiry/order.

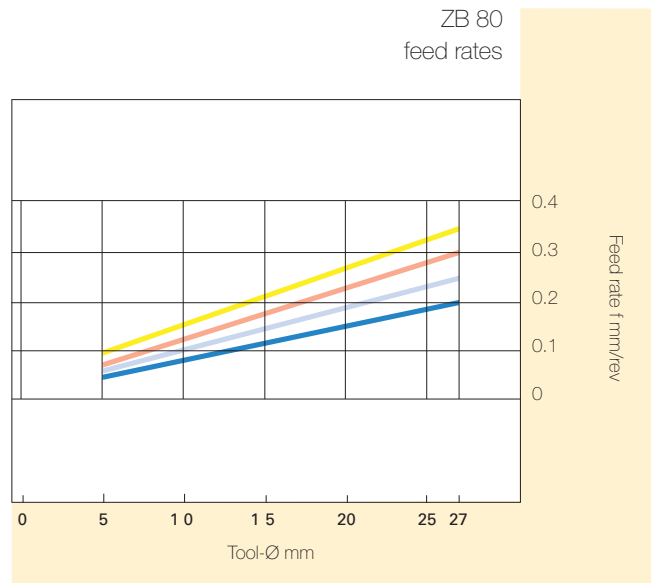
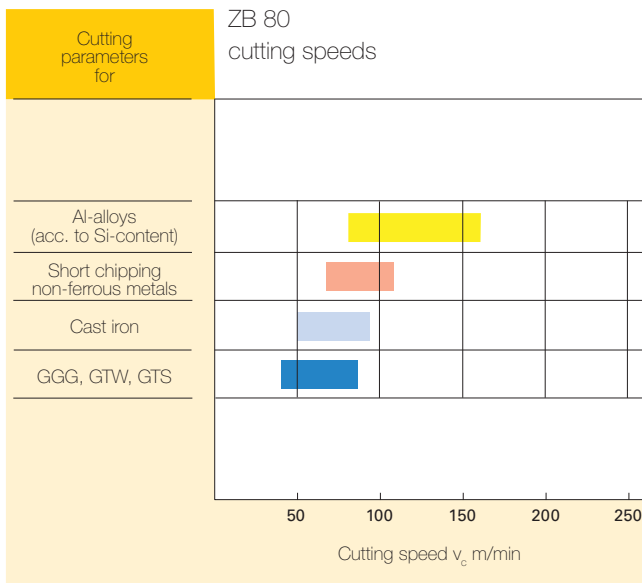

(Detailed cutting parameters see GuhringNavigator)

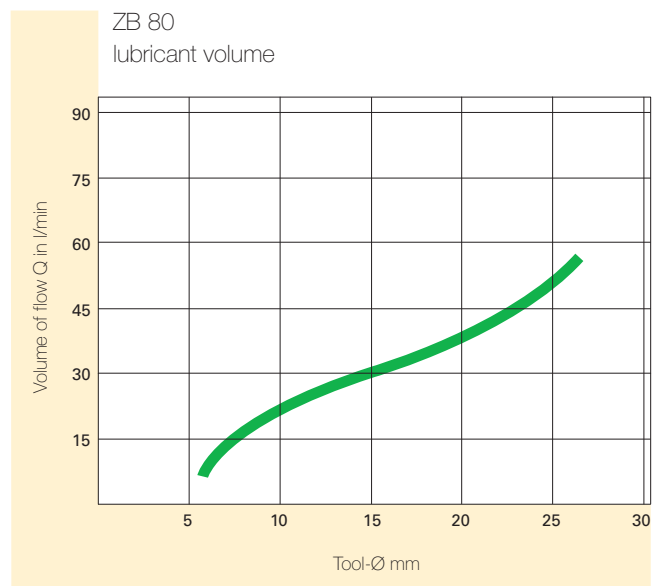
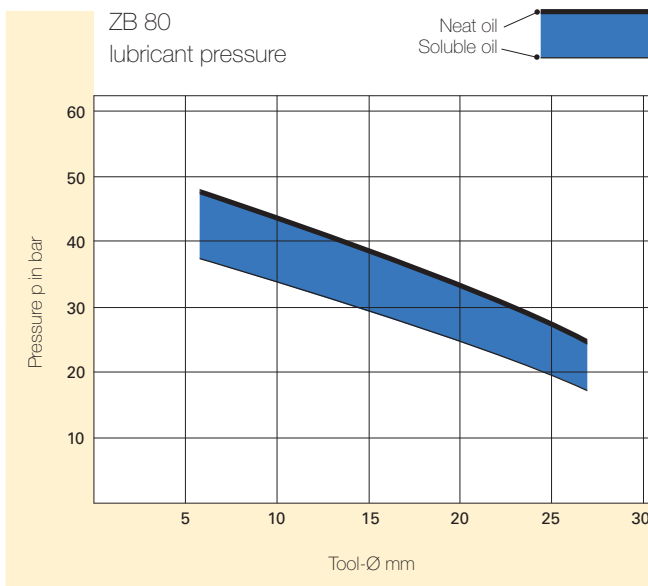

Technical



with interchangeable inserts and supporting strips, suitable for most materials, from Ø 16.0 - 40.0 mm, max. total length 3000 mm

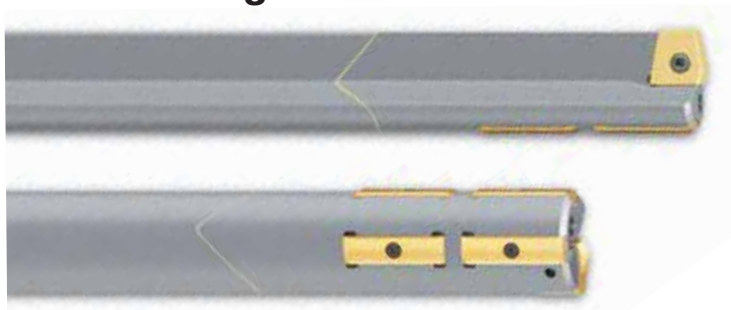

Guhring single-fluted gun drills with interchangeable inserts and supporting strips are also produced as special tools according to customer requirements. They are suitable for nearly every material and available from diameter 16.0 to 40.0 mm up to a maximum total length of 3000 mm.

Your special advantages are:

- The interchangeable component technology for inserts and supporting strips makes any combination of carbide grade and coating possible.
- The precision interchangeable inserts and supporting strips eliminate complicated adjustments.
- The precision supporting strips are produced in a special carbide for your individual deep drilling task. They can be reverse-fitted, providing double tool life. In addition, they can be provided with any of the Guhring coatings.
- Thanks to the precision insert seatings and the interchangeable inserts there is only a small number of interchangeable components. The tool is therefore extremely rigid.

- Expensive stoppages are eliminated because the worn components can be replaced without removing the tool from the machine.
 - The expensive re-grinding process is eliminated thanks to the interchangeable insert technology.
 - The application orientated selection of the most suitable interchangeable insert always ensures optimal chip breaking – even in problematic materials.
 - Specifically optimized to your individual deep drilling task, the precision inter-changeable inserts are also produced in a special carbide. In addition, all Guhring coatings are available.
 - Within the diameter range it is possible to modify the nominal diameter at any time by simply interchanging the individual components.
 - The driver is produced in heat-treatable steel acc. to:
 - DIN 6535 HA - DIN 6535 HE
 - DIN 6535 HB - DIN 1835 E
- Also, all the forms generally required for deep drilling machines are possible to be manufactured.

GUHRING EB 800 for your application

**Attention: shortest flute length 15 x D
- possible diameter tolerance IT9/IT10**

Drawing, all Guhring nos. and specifications included with every quote.

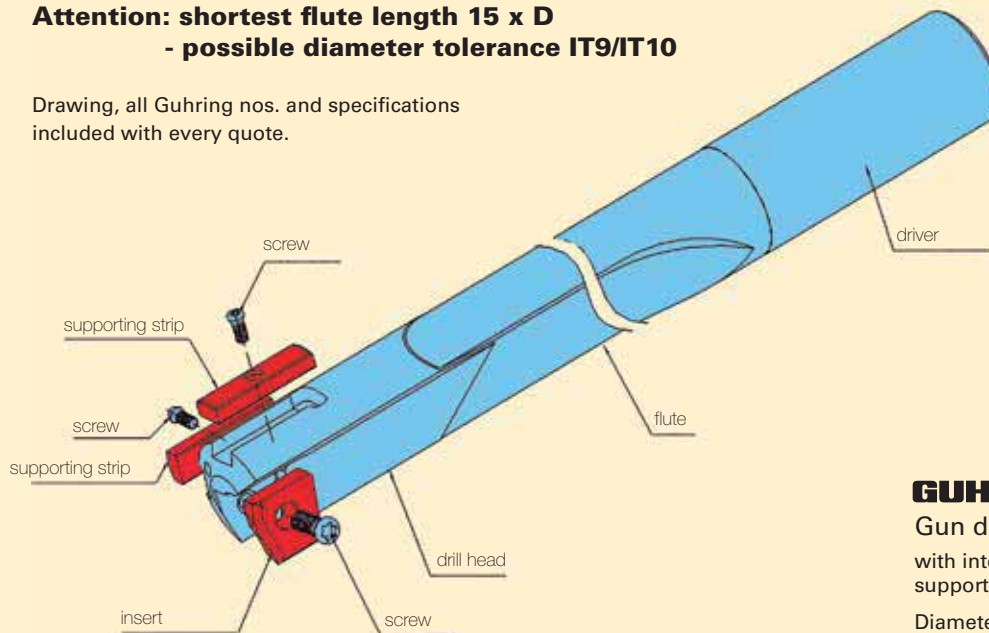

GUHRING

Gun drills

with interchangeable insert and supporting strip, internal cooling

Diameter range: 16.00 mm - 40.00 mm

Ranges of nominal diameters

Size	Ø range (mm)
1.00	16.00 - 16.49
1.01	16.50 - 16.99
1.02	17.00 - 17.49
1.03	17.50 - 17.99
1.04	18.00 - 18.49
1.05	18.50 - 18.99
1.06	19.00 - 19.49
1.07	19.50 - 19.99
2.00	20.00 - 20.49
2.01	20.50 - 20.99
2.02	21.00 - 21.49
2.03	21.50 - 21.99
2.04	22.00 - 22.49
2.05	22.50 - 22.99
2.06	23.00 - 23.49
2.07	23.50 - 23.99
2.08	24.00 - 24.49
2.09	24.50 - 24.99
2.10	25.00 - 25.49
2.11	25.50 - 25.99
3.00	26.00 - 26.49
3.01	26.50 - 26.99
3.02	27.00 - 27.49
3.03	27.50 - 27.99

Every tool can be modified within the diameter range

Size	Ø range (mm)
3.04	28.00 - 28.49
3.05	28.50 - 28.99
3.06	29.00 - 29.49
3.07	29.50 - 29.99
4.00	30.00 - 30.49
4.01	30.50 - 30.99
4.02	31.00 - 31.49
4.03	31.50 - 31.99
4.04	32.00 - 32.49
4.05	32.50 - 32.99
4.06	33.00 - 33.49
4.07	33.50 - 33.99
5.00	34.00 - 34.49
5.01	34.50 - 34.99
5.02	35.00 - 35.49
5.03	35.50 - 35.99
5.04	36.00 - 36.49
5.05	36.50 - 36.99
5.06	37.00 - 37.49
5.07	37.50 - 37.99
6.00	38.00 - 38.49
6.01	38.50 - 38.99
6.02	39.00 - 39.49
6.03	39.50 - 40.00

Every tool can be modified within the diameter range

To ensure EB 800 is designed and produced specifically for your application, please complete the questionnaire and use for your inquiry/order.

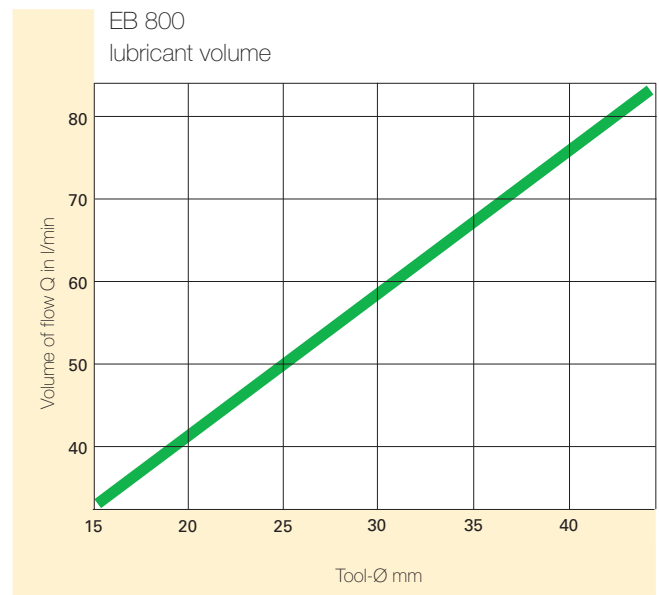
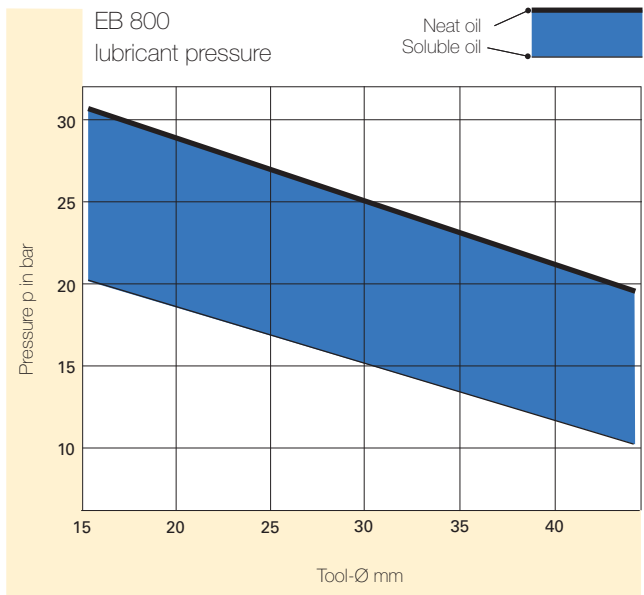
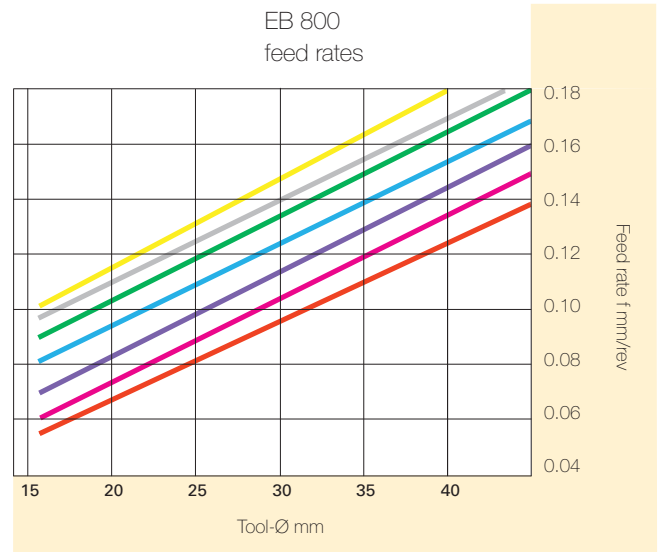
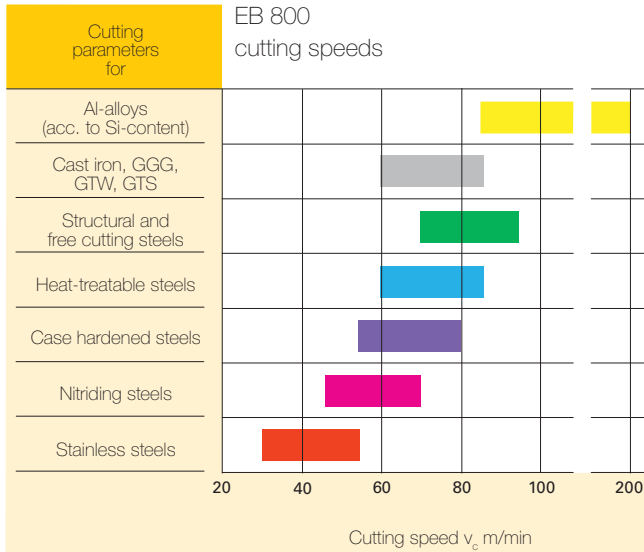

Technical

TBM 116

TBM 116 is a manually operated, universal grinding machine. Its compact design combined with Guhring's single-fluted gun drill grinding system and Guhring's double grinding wheel makes this a perfect unit to re-grind single-fluted gun drills. It is especially suitable for the re-grinding of a small to medium number of items of varying diameters and lengths. Furthermore, it also allows the fairly simple addition of transverse chip breakers to single-fluted gun drills as well as other modifications.

Supplied items:

Grinding machine with two high-powered light units as well as two 220 V sockets (grinding system and grinding wheel not included)

Machine data:

Input power requirements 380 V/50 Hz, Grinding wheel 2850 rev./min, Max. diameter of grinding wheel 150 mm



TBV 116

The fixture is designed for the re-grinding of single-fluted gun drills in the diameter range from 3 mm to 30 mm. It is ideally suitable for standard and special point grinds. A minimum flute length is of no importance thanks to a short center sleeve. In addition, the fixture is supplied with a supporting bar for long tools. TBV 116 is therefore truly universal and can be applied on any commercial, manual tool grinding machine.

With TBV 116 we recommend our double grinding wheel DSS 125.

Attention:

Single-fluted gun drills have a flute spacing angle of 120° and can therefore not be clamped in a collet in a separate unit. You could possibly destroy the tool.



TBV 216

The new TBV 216 universal grinding fixture for small diameter single-fluted gun drills from 1.0 to 6.0 mm and a maximum length of 350 mm is simple to handle and enables the re-grinding or modifying of single-fluted gun drills in only four operations. Grinding is achieved with a 3-axis swivel mechanism, enabling the grinding of various point angles. It is possible to adjust and if necessary correct any angle individually.

We recommend the application of our single grinding wheel ESS 125.

To include:

- A set of guide bushes with the diameters 1.0 / 1.5 / 2.0 / 2.5 / 3.0 / 3.5 mm
- Various adaptors
- Centering microscope
- Spotlight and magnifier



Additional technical parameters

The range of drivers introduced below is available ex stock. However, it only represents a small selection of drivers from our complete range. We naturally also produce individual drivers of the highest precision to

customer drawings. Attention! EB 100 requires drivers with positioning lugs. Further information on request.

Drivers for deep drilling machines				
1				
	d_1	l_1	l_2	l_3
code no.				
1.1	10	40	24	-
1.2	10	40	24	45
1.3	10	40	24	55
1.4	16	45	31,2	-
1.5	25	70	34	-
1.6	25	70	34	78
2				
	d_1	l_1	l_2	l_3
code no.				
2.1	16	50	47	-
2.2	16	50	47	55
2.3	16	50	47	70
3				
	d_1	l_1	l_2	l_3
code no.				
3.1	25	70	34	100
4				
	d_1	l_1		
code no.				
4.1	19,05	70		
5				
	d_1	l_1	l_2	
code no.				
5.1	10	60	20	
5.2	16	80	28	
5.3	25	100	50	
6				
	d_1 (inch)	l_1		
code no.				
6.1	1/2	38		
6.2	3/4	70		
7				
	d_1	l_1	l_2	
code no.				
7.1	16	112	73	
7.2	20	126	82	

Drivers to DIN 1835		
9 form E		
	d_1	l_1
code no.		
9.1	8	36
9.2	10	40
9.3	12	45
9.4	16	48
9.5	20	50
9.6	25	56
9.7	32	60

Drivers to VDI draft		
12		
	d_1	l_1
code no.		
12.1	10	68
12.2	16	90
12.3	25	112

Drivers to Speed-Bit-System			
13			
	d_1	l_1	l_2
code no.			
13.1	16	40	16
13.2	25	50	25

Drivers to DIN 6535		
10 form HA		
	d_1	l_1
code no.		
10.1	8	36
10.2	10	40
10.3	12	45
10.4	16	48
10.5	20	50
10.6	25	56
10.7	32	60

Drivers to VDI draft		
8 form HB		
	d_1	l_1
code no.		
8.1	8	36
8.2	10	40
8.3	12	45
8.4	16	48
8.5	20	50
8.6	25	56
8.7	32	60
8.8	40	70

Drivers to VDI draft		
11 form HE		
	d_1	l_1
code no.		
11.1	8	36
11.2	10	40
11.3	12	45
11.4	16	48
11.5	20	50

Examples for special point geometries for single-fluted gun drills

(further geometries on request)

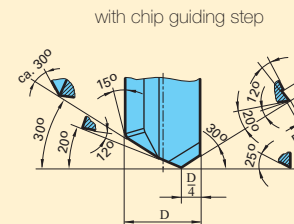
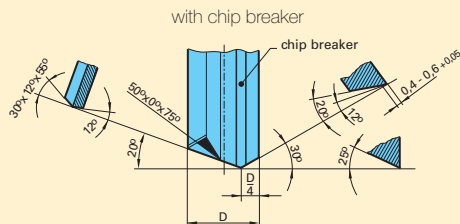
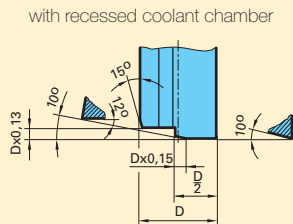

Driver variations to suit gun drill tubes

Solution for $nom.-\varnothing < driver-\varnothing$ (difference must be appr. 6 mm):
tube shank installed in driver

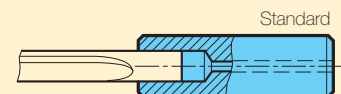

Solution for $nom.-\varnothing \neq driver-\varnothing$ (close to parallel):
tube shank installed over spigot

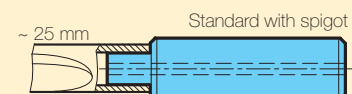

Solution for $nom.-\varnothing > driver-\varnothing$:
tube shank installed over spigot, inside- \varnothing of tube shank $> driver-\varnothing$,
tube shank fits against collar shoulder.

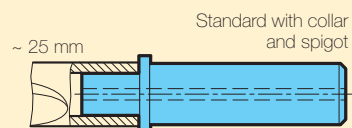

High speed steels

Only high quality materials are used to produce Guhring HSS tools. Systematic selection of alloying elements ensure the tool possesses the optimal characteristics for the individual application.

Tungsten, Molybdenum: increase tempering- and wear-resistance

Vanadium: increases wear-resistance of finishing tools

Cobalt: enables increased hardening temperatures and improves heat-resistance.

Guhring description	German steel descript.	Material no. (steel code)	Range of application	comparable steels			
				USA	France	Italy	Great Britain
HSS	HS 6-5-2 (DMo5)	1.3343	standard tool material for most common applications	M 2	Z 90 WDCV 06-05-04-02	HS 6-5-2	BM 2
HSCO HSS-E	HS 6-5-2-5 (EMo5Co5)	1.3243	high heat-resistance, especially suited for roughing or when coolant insufficient	M 35	Z 90 WDKCV 06-05-05-04-02	HS 6-5-2-5	BM 35
HSS-E	S 6-5-3 (EMo5V3)	1.3344	high friction resistance and cutting edge stability, especially important for reaming operations	M 3	Z 120 WDCV 06-05-04-03	HS 6-5-3	-
M42	HS 2-9-1-8	1.3247	increased heat resistance and hardness, suitable for difficult-to-machine materials	M 42	Z 110 DKCWV 09-08-04-02-01	HS 2-9-1-8	BM 42
HSS-E							
HSS-E-PM	10-2-5-8 PM52	1.3253	high hardness, heat-resistance and cutting edge stability, very dense structure	-			
	HS 6-5-3-8 PM30	1.3294					

Superhard tool materials

It is not only the extreme hardness of superhard tool materials but also their high heat-resistance which enables highest cutting rates and increased productivity. One disadvantage is however their low toughness.

Economical application is only possible on extremely rigid

machines and for a specific range of application. Further information regarding PCD and CBN can be found in the Diamond Tool section of this catalogue, our Cermet reamers are covered in the Technical Section under Reaming Tools.

Guhring description	Classification	Range of application	Average grain size	Diamond content
PCD	Fine grain	Aluminium and AISi-alloys <10%Si, magnesium alloys, brass, copper, bronze, wood composite materials excellent cutting edge quality high abrasion resistance excellent surface qualities	2-4µm	approx. 90%
	Medium grain	Universal grade (general finishing applications) AISi-alloys <14%Si, copper alloys, graphite and graphite composite materials, wood composite materials, unsintered ceramic and carbide (<15% binding metal content) excellent resistance good surface qualities	5-10µm	approx. 92%
	Coarse grain	Roughing and finishing applications AISi-alloys >14%Si and other abrasive machining applications, MMC, sintered ceramic and carbide (<15% binding metal content) extreme abrasion resistance, high shock resistance long tool life with acceptable to good surface quality	25µm	approx. 94%
	Mixed grain	Abrasive machining applications (i.e.: >14% AISi-alloys, MMC, composite materials) highest wear resistance, excellent shock resistance extreme abrasion resistance with good edge roughness long tool life with good surface quality	2-4µm+ 25µm	approx. 95%
CBN 10..	Low CBN-content	CBN tool material with carbide base for finishing machining of, for example, case hardened steels, heat-treatable steels, tool steels, grey cast iron, suitable for continuous and interrupted cut applications (especially hard turning) with a chip removal <0.5mm, high pressure resistance, low thermal conductivity, excellent abrasion resistance, chemical stability, good shock toughness for high removal rates, excellent surface finish and long tool life	2µm	50-65% CBN content
CBN 20..	High CBN-content with carbide base	CBN tool material with carbide base for the machining of, for example, pearlitic grey cast iron (> 45 HRC), hardened steel, tool and structural profile steels, powder metallurgic Fe-sinter materials, alloys on Ni/Cr basis (nickel base alloys - „superalloys“) thermal sprayed alloy & hard coatings on Co-, Ni- and Fe-basis suitable for continuous and interrupted cut applications with a medium chip removal (typical 0.5 - 1.5mm) high thermal conductivity, high break toughness, high surface qualities	2µm	80-95% CBN content
CBN 30..	High CBN-content without carbide base	Solid CBN tool material without carbide base for rough machining of pearlitic grey cast iron, chilled cast iron (> 45 HRC), hardened steels with high break toughness, excellent wear resistance, very good chemical stability, high specific removal rates For the application in tool holders, drilling and boring tools, recessing tools as well as cutter heads with clamping element and negative rake angle geometry	15µm	80-95% CBN content
Cermet	TCN 54 P15/P20	high cutting edge stability, for finishing tools such as reamers	< 2.5µm	

Main material group P

This group includes long-chipping ferrous metals except stainless and austenitic steels and is, according to the cutting load, divided into the application groups 01-50.

Main material group M

Group M includes austenitic stainless steels, austenitic/ferritic steels and cast steels. The group is subdivided into the application groups 01-40, dependent on the cutting load. At Guhring, P and M applications are achieved with coated K carbide.

Main material group K

Group K incorporates all forms of grey cast iron and malleable cast iron. Dependent on cutting load it is subdivided into the application groups 01-40.

Main material group S

Heat-resistant "super alloys" based on iron, nickel or cobalt as well as titanium alloys are included in group S. It is divided into the application groups 01-30, dependent on the cutting load.

Main material group N

This group includes non-ferrous metals, especially aluminium-alloys and non-metal materials. It is, depending on the cutting load, divided into the application groups 01-30.

Main material group H

This group includes hard machining of hardened steels. The application groups are from 01-30, depending on the cutting load.

Many carbide grades cover the broad spectrum of the main material groups, especially when coated tools are applied. For example, most of the FIRE-coated carbide drills in the Guhring range are assigned to the main material groups K and P.

Individual Guhring grades

The following table lists the most important carbides that are available from Guhring ex-stock for general applications. Further carbide grades are available on request and detailed information can be found at www.guehring-carbide.de

In more than 80% of applications known to Guhring, the results of DK460UF carbide grade tools together with a specially adapted coating could not be surpassed by any other carbide grades, including coated tools. This and the availability of the material ex-stock simplify tool selection immensely. For further information regarding the application of other carbide grades please contact our technical engineers.

Guhring description	Co-content [M-%]	Tungsten carbide grain size [µm]	Hardness [HV]	ISO classification [ISO 513]	Characteristics
DK460UF	10	0.5	1620	K20-K40 coated: P, M20-M40, H, S, N25	A carbide grade with wide range of application possibilities. It is applied, mostly coated, for the machining of steel, soft Al alloys, cast iron as well as "super alloys" such as Inconel 718. This grade is the backbone of our carbide production.
DK500UF	12	0.5	1680	K25 coated: P, M, H, S, N25	The grade has been especially developed for hard machining. It possesses a higher hardness and deformation tolerance in comparison to DK460UF. Due to the high Co-content, a coated application is strongly recommended.
DK255F	8	0.7	1720	K20 coated: P, M, H, S, N20	The grade is recommended for hard machining, the machining of high tensile grey cast iron and hard AlSi-alloys. Dry machining is possible. A coated application is preferable.
DK120	6	1.3	1620	K15 coated: N15	The grade is especially suitable for the application with diamond coating.
DK120UF	7	0.5	1850	K05	Ultra fine grain type offering extreme wear resistance, suitable for absolutely rigid machines, preferred for reamers.
K55SF	9	0.2 -0.5	1920	K10-K30	For application with high wear resistant materials, stainless steels, composite materials such as Kevlar and GRP, high speed machining and dry machining.
DK400N	10	0.7	1580	K35M coated: P, M, S, N35M	An extremely tough grade for the machining of high heat resistant metals.

Basic characteristics of carbide for drilling applications

Carbide

Carbide, similar to steel, is a less than precise and indeed a very general term for an entire material group. Carbide can be produced in an infinite number of variations with different characteristics through the combination of at least two basic constituents.

Carbide production

Carbide consists of a hardness carrier – tungsten carbide plus maybe one or more carbides – and an extremely tough component: Cobalt (Co). Cobalt basically serves as a cementing or binding agent in which the carbide particles are distributed.

In order to satisfy the diverse demands that, dependent on the individual application task, are placed on carbide, Guhring offers a choice of more than 20 different standard carbide types. Some are especially hard, others possess a very high toughness, some are ultra fine grain and others are coarse. Furthermore, on the request of the customer, any conceivable carbide grade can be developed and produced as a special carbide, so-to-speak.

Our carbide division has a state-of-the-art laboratory at its disposal to ensure our carbide always corresponds with customer requirements. From the raw material to the finished product, samples are continuously examined in order to guarantee and document the highest quality and process reliability in accordance with the certification.

For drilling applications the following characteristics are of importance:

Rigidity

Rigidity is a measure of the energy that is required to force a material to deform. With carbide it is determined by the cobalt content. The higher the cobalt content, the lower the rigidity of the material.

The rigidity of conventional carbide is more than double compared to that of steel. Subsequently, holes of considerably greater straightness can be produced with carbide drills than with steel drills. However, this positive effect of the rigidity is limited because of deformation forced upon the drill – for example through offset or imbalance – result in a heavy increase in load on the material. Therefore, more rigid materials are also more prone to breakage.

Hardness

Hardness is described as the resistance of a material against penetration of another. It is clear, that the tool material must be considerably harder than that of the work piece, in order to not be exposed to excessive wear.

There are several possibilities to adjust the hardness of carbide: on the one hand by modifying the cobalt content and on the other hand by varying the carbide grain size. If the cobalt content is increased whilst retaining the same grain size, the hardness of the carbide is reduced. However, if the grain size is reduced whilst retaining the same cobalt content, the hardness is increased.

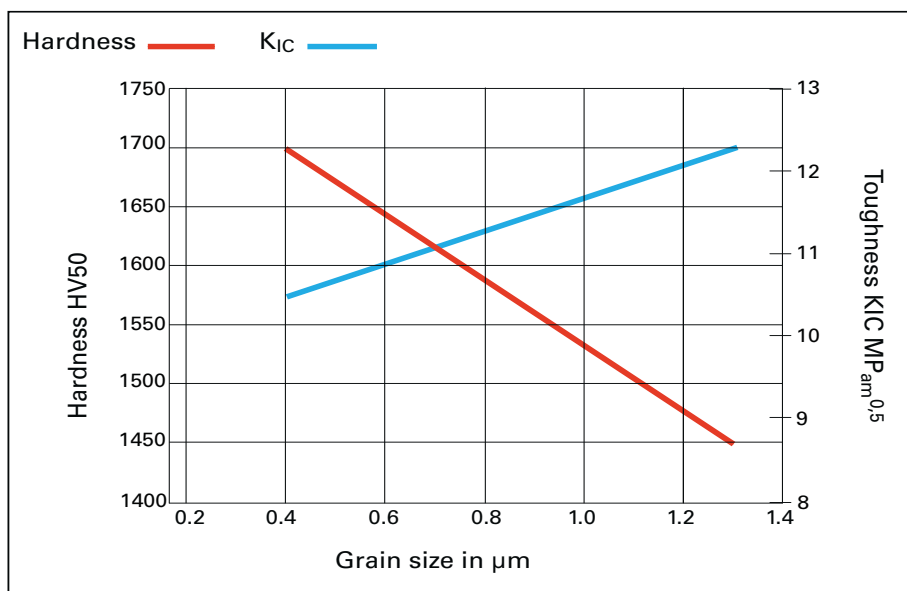

The new material abbreviations (selection)

mat. nos.	ASTM / SAE / AISI	DIN abbreviation	mat. nos.	ASTM / SAE / AISI	DIN abbreviation	mat. nos.	ASTM / SAE / AISI	DIN abbreviation	mat. nos.	ASTM / SAE / AISI	DIN abbreviation
0.6010	A48-20 B	EN-GJL-100	1.0756	11L39	35SPb20	1.4511		X3CrNb17	1.7219	4125	26CrMo4-2
0.6020	A48-30 B	EN-GJL-200	1.0757		46SPb20	1.4512	409	X2CrTi12	1.7220	4135, 4137	34CrMo4
0.6025	A48-40 B	EN-GJL-250	1.0760		38SMn26	1.4520		X2CrTi17	1.7225	4140, 4142	42CrMo4
0.6035	A48-50B	EN-GJL-350	1.0761		385MnNb26	1.4521	443, 444	X2CrMoTi18-2	1.7226	4135	34CrMoS4
0.7050	65-45-12	EN-GJS-500-7	1.0762		44SMn28	1.4522		X2CrMoNb18-2	1.7227	4140	42CrMoS4
0.7070	100-70-03	EN-GJS-700-2	1.0763		445MnNb28	1.4532	AL 15-7	X8CrNiMoAl15-7-2	1.7228	4147	50CrMo4
0.8035		EN-GJMW-350-4	1.0873		DC06 [Fe P06]	1.4541	321	X6CrNiTi18-10	1.7264	4118	20CrMo5
0.8155		EN-GJMB-550-4	1.1103		S255NL1	1.4542	630	X5CrNiCuNb16-4	1.7321		20MoCr4
0.8170		EN-GJMB-700-2	1.1105		S315NL1	1.4550	347, 348	X6CrNiNb18-10	1.7323		20MoCrS4
1.0022		-	1.1121	1010	C10E	1.4558	B407-409	X2NiCrAlTi32-20	1.7333		22CrMoS3-5
1.0035	A283 Gr A	S185	1.1141	1015	C15E	1.4567	18-9-LW	X3CrNiCu18-9-4	1.7335	A182-F11, F12	13CrMo4-5
1.0039		S235JRH	1.1151	1020, 1023	C22E	1.4568	17-7	X7CrNiAl17-7	1.7362	501	12CrMo19-5
1.0044	1020, AG570 Gr40	S275JR	1.1158	1025	C25E	1.4571	316 Ti	X6CrNiMoTi17-12-2	1.7380	A182 F22, A387	10CrMo9-10
1.0050	A570/572 Gr50	E295	1.1170	1330	28Mn6	1.4577		X3CrNiMoTi25-25	1.7383		11CrMo9-10
1.0060	A572 Gr 65	E335	1.1178	1030	C30E	1.4592		X2CrMoTi29-4	1.7779		20CrMoV13-5-5
1.0070		E360	1.1181	1035, 1038	C35E	1.4713		X10CrAlSi7	1.8159	6145, 6150	51CrV4
1.0114		S235J0	1.1186	1040	C40E	1.4724		X10CrAlSi13	1.8504		34CrAl6
1.0226		DX51D	1.1191	1045	C45E	1.4742		X10CrAlSi18	1.8519		31CrMoV9
1.0242		S250GD	1.1203	1055	C55E	1.4762	(446)	X10CrAlSi25	1.8550		34CrAlNi7
1.0244		S280GD	1.1206	1049, 1050	C50E	1.4821		X20CrNiSi25-4	1.8807		13MnNiMoV5-4
1.0250		S320GD	1.1221	1060, 1064	C60E	1.4828	309	X15CrNiSi20-12	1.8812		18MnMoV5-2
1.0301	1010	-	1.1241	1050	C50R	1.4833	309 S	X7CrNi23-12	1.8815	4012	18MnMoV6-3
1.0302	10L10	-	1.1750	W1	C75W	1.4841	314, 310	X15CrNiSi25-21	1.8821		P355M
1.0306		DX54D	1.2067	L 1, L 3	102Cr6	1.4845	310 S	X12CrNi25-21	1.8824		P420M
1.0312	1005, G10050	DC05 [Fe P05]	1.2080	D 3	X210Cr12	1.4864	330	X12NiCrSi35-16	1.8826		P460M
1.0319	1013, G10030	L210GA	1.2083		X42Cr13	1.4878	321	X10CrNiTi18-10	1.8828		P420ML2
1.0322	1008, G10080	DX56D	1.2419	07,T31507	105WCr6	1.4903		X10CrMoVNb9-1	1.8831		P460ML2
1.0330	A366 (1012), 1008	DC01 [Fe P01]	1.2767		X45NiCrMo4	1.5026	9255	55Si7	1.8832		P355ML1
1.0333	A619 (1008)	-	1.3243	M5, M41	S 6-5-2-5	1.5131		50MnSi4	1.8835		P420ML1
1.0338	A620 (1008)	DC04 [Fe P04]	1.3343	M 2	S 6-5-2	1.5415	A204 GrA, 4017	16Mo3	1.8837		P460ML1
1.0345	A516, A515 Gr	P235GH	1.3344	M3 Class 2	S 6-5-3	1.5530		20MnB5	1.8879		P690Q
1.0347	A619	DC03 [Fe P03]	1.4000	403, 410S, 429	X6Cr13	1.5531		30MnB5	1.8880		P690QH
1.0348		P195GH	1.4002	405	X6CrAl13	1.5532		38MnB5	1.8881		P690QL1
1.0350		DX52D	1.4003		X2CrNi12	1.5637	A350-LF3	12Ni14	1.8882		10MnTi3
1.0355		DX53D	1.4005	416	X12CrS13	1.5662	A353	X11CrMo5+I	1.8888		P690QL2
1.0356	1013	P215NL	1.4006	410, CA-15	X12Cr13	1.5680	2515, 2517	X12Ni5	1.8900		S380N
1.0358		-	1.4016	430	X6Cr17	1.5710	3135	36NiCr6	1.8901		S460N
1.0401	M1015/16/17	-	1.4021	420	X20Cr13	1.5715		16NiCrS4	1.8902	A633 Gr E	S420N
1.0402	(M) 1020, M1023	C22	1.4028	420 F	X30Cr13	1.5752	3310, 3415, 9314	15NiCr13	1.8903		S460NL
1.0403	10L15	-	1.4031	420	X38Cr13	1.6210		15MnNi6-3	1.8905	A633 Gr E	P460N
1.0406	(M) 1025	C25	1.4034	4105	X46Cr13	1.6211		16MnNi6-3	1.8907		S500N
1.0419	1016	L355	1.4037		X65Cr13	1.6310		20MnMoNi5-5	1.8910		S380NL
1.0424	1513	P265	1.4057	431	X17CrNi16-2	1.6311		20MnMoNi4-5	1.8911		S380NL1
1.0424		P265	1.4104	430 F	X14CrMoS17	1.6341		11NiMoV5-3	1.8912		S420NL
1.0425		P265GH	1.4105		X6CrMoS17	1.6368		15NiCuMoNb5	1.8913		S420NL1
1.0429		L290MB	1.4109	440A	X70CrMo15	1.6511	4340, 9840	36CrNiMo4	1.8915		P460NL1
1.0457	1013	L245NB	1.4110		X55CrMo14	1.6523	8620	21NiCrMo2-2	1.8917		S500NL
1.0459		L245GA	1.4112	440B	X90CrMoV18	1.6526	8620	21NiCrMoS2-2	1.8918		P460NL2
1.0461		S255N	1.4113	434	X6CrMo17-1	1.6580		30CrNiMo8	1.8919		S500NL1
1.0473	A537 Cl1, A414GrG	P355GH	1.4116		X50CrMoV15	1.6582	4337, 4340	34CrNiMo6	1.8930		P380NH
1.0481	A515 Gr70	P295GH	1.4120		X20CrMo13	1.6587	4317	18CrNiMo7-6	1.8932		P420NH
1.0484		L290NB	1.4122		X39CrMo17-1	1.7003	50B40	38Cr2	1.8935		P460NH
1.0486		P275N	1.4125	440 C	X105CrMo17	1.7006	5045, 5046	46Cr2	1.8937		P500NH
1.0501	1035	C35	1.4301	304, 304H	X5CrNi18-10	1.7016	5117	17Cr3	1.8972	1522	L415NB
1.0503	1045	C45	1.4303	305, 308	X4CrNi18-12	1.7023	50B40	38CrS2	1.8973		L415MB
1.0505		P315N	1.4305	303	X8CrNiS18-9	1.7025	5045	46CrS2	1.8975		L450MB
1.0511	1040	C40	1.4306	304 L	X2CrNi19-11	1.7030	5130	28Cr4	1.8977		L485MB
1.0528	1030	C30	1.4310	301	X10CrNi18-8	1.7033	5132	34Cr4	1.8978	1522	L555MB
1.0529	1522	S350GD	1.4311	304 LN	X2CrNiN18-10	1.7034	5135	37Cr4			
1.0535	1055	C55	1.4313	CA 6-NM	X3CrNiMo13-4	1.7035	5140	41Cr4			
1.0539		S355NH	1.4318		X2CrNiN18-7	1.7036		28CrS4			
1.0540	1050	C50	1.4335	3105	X1CrNi25-21	1.7037	5132	34CrS4			
1.0547		S355J0H	1.4361		X1CrNiSi18-15-4	1.7038	5135	37CrS4			
1.0582	1518	L360NB	1.4362	2304	X2CrNiN23-4	1.7039	5140	41CrS4			
1.0601	1060	C60	1.4401	316	X5CrNiMo17-12-2	1.7131	5115	16MnCr5			
1.0710		-	1.4404	316 L	X2CrNiMo17-12-2	1.7139	5117	16MnCrS5			
1.0715	1213	11SMn30	1.4410	2507	X2CrNiMoN25-7-4	1.7043	5135	38Cr4			
1.0718	12 L 13	11SMnNb30	1.4418		X4CrNiMo16-5-1	1.7147	5120	20MnCr5			
1.0721	1108, 1109	10S20	1.4435	316 L	X2CrNiMo18-14-3	1.7149	5120	20MnCrS5			
1.0722	11 L 08	10SPb20	1.4436	316	X3CrNiMo17-13-3	1.7176	5155, 5160	55Cr3			
1.0726	1140	35S20	1.4438	317 L	X2CrNiMo18-15-4	1.7182		27MnCrB5-2			
1.0727	1146	46S20	1.4460	329	X3CrNiMoN27-5-2	1.7185		33MnCrB5-2			
1.0728	1151	-	1.4462	2205	X2CrNiMoN22-5-3	1.7189		39MnCrB6-2			
1.0736	1215	11SMn37	1.4509		X2CrTiNb18	1.7213		25CrMoS4			
1.0737	12 L 14	11SMnNb37	1.4510	XM 8, 430Ti	X3CrTi17	1.7218	4130	25CrMo4			



Bloomfield, CT



Huntington Beach, CA



Brookfield, WI



New Hudson, MI

Coating and Reconditioning Services

Guhring opened its fourth reconditioning center, in Bloomfield, CT. The new facility provides reconditioned carbide tools and PVD coatings.

The other reconditioning facilities are in Brookfield, WI., New Hudson, MI., and Huntington Beach, CA.



Basic properties

○ bright

High speed steel or carbide tools generally offer good basic properties even without surface refinement or coating. In addition, bright tools from Guhring's standard range serve as base tools for a cost-efficient coating with all Guhring coatings to customer specification

● steam nitrided

● nitrided lands

This finish is recommended for the machining of grey cast iron, aluminium with a high silicon content, plastics, steels with a high perlite content etc. Our tools are nitrided using different application orientated processes.





Surface refining processes

For special application cases a surface refinement is recommended that improves the wear-resistance as well as the gliding properties and decreases the welding tendency. Because hard or soft material coatings provide much better results surface refinement is increasingly losing importance.



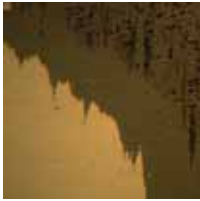
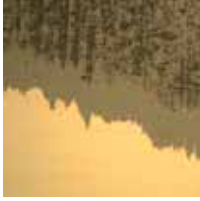

● steam tempered

Steam tempered tools can prevent cold welding that can occur when machining low-carbon steels. However, they are only suitable for the machining of ferrous materials.

Guhring coatings

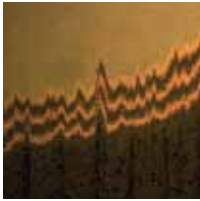
	TiAlN A	TiAlN Super A/nanoA A a	TiCN C	Carbo Cb	Cristall D
					
Colour	violet	grey-violet	grey violet	black	anthrazite
hardness	3200 HV	3400 HV	3000 HV	> 6000 HV	> 8000 HV
Friction coefficient	0.55	0.6	0.4	< 0.1	< 0.1
max. application temperature	< 800°	< 900°	< 400°	< 700°	< 700°
Thermal expansion	7.2 * 10 ⁻⁶ /K	6.9 * 10 ⁻⁶ /K	–	3 * 10 ⁻⁶ /K	1.1 * 10 ⁻⁶ /K
Brief description	Hard coating for abrasive applications, HPC and MQL	Hard coating for difficult and hard machining, HPC as well as MQL	Tough hard coating	Extremely hard coating	Extremely hard diamond coating

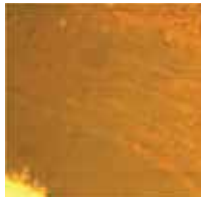
Special coatings

	FIREX/nano-FIREX F	AlCrN P	TiN·TiN+ S S+	nano-Si Y	ICE
					
Colour	violet	grey-blue	golden yellow	bronze-red	grey metallic
hardness	3300 HV	3200 HV	2300 HV	5500 HV	3500 HV
Friction coefficient	0.6	0.35	0.5	0.55	0.6
max. application temperature	< 800°	< 1100°	< 600°	< 800°	< 1000°
Thermal expansion	–	6.4 * 10 ⁻⁶ /K	9.3 * 10 ⁻⁶ /K	7.5 * 10 ⁻⁶ /K	–
Brief description	Wear-resistant multi-layer coating, also for MQL	Wear-resistant coating with high oxidation resistance and temperature hardness	Cost-efficient standard coating	Extremely hard, heat-resistant multi-layer coating	Hard, high heat-resistant coating

Application recommendations

	Drilling			Milling			Tapping			Thread milling		Fluteless tapping			Reaming		
	conv.	MQL		conv.	MQL		conv.	MQL		conv.	MQL	conv.	MQL		conv.	MQL	
Steel unalloyed	F A Y	F A Y	F S	F a A	F a A	F C	C S	S C	C S A	C A	C A	C S C	S S C	C P	A A	A S	
Steel alloyed	F A Y	F A Y	F S	F a Y	F a Y	F C	C S	S C	C S A	C A	C A	C S C	S S C	C P	A A	A S	
Steel hardened <55-HRc	F A Y	F A		Y A A	Y A A		A A C	A A	C A	C A		C C C	S S C	C P	A A		
Steel hardened 55-65-HRc	A F Y	F Y		Y A A	Y A A		A			A					A		
Steel rust and acid-resistant	a F Y	a F Y	F S	a F Y	a F Y	F S	A A C	A A S	C S A	C A		C S C	C P S	C P	A A	A S	
Cast iron	Y F A	Y F A	F	Y F A	Y F A	F C	a A S	a C	A C	A A		C S C	C P S	C P	A A	A S	
Aluminium wrought alloys	○ Cb D	○ Cb D	○ Cb	○ Cb D	○ Cb D	○ Cb	Cb ○	Cb ○ Cb	○	○		Cb C	Cb	Cb	Cb		
Aluminium cast alloys	○ D Cb	○ D Cb	○ Cb	○ Cb D Cb	○ D Cb	○ Cb	○ Cb	○ Cb Cb	○	○		Cb	Cb	Cb	Cb		
Nickel alloys	a F	a F	F	a F	a F	F		A C	C A	C A		C C	C C	P C	A A	A S	
Titanium	a F	a		a F		F		A C	C A	C A		C C	C C	C P	A A	A S	
Copper	ICE	ICE	S	ICE	ICE	S	ICE	ICE	○	○		ICE	ICE	S	A	A	S
Bronze/brass	ICE	ICE	S	ICE	ICE	S	ICE	ICE	○			ICE	ICE	S	A	A	S
Cobalt-chromium Alloys	a F	a F		a Y F	a Y F										A	A	S
Precious metals	a	a		a	a										A	A	S
Ceramics, pre-sintered	D	D		D	D												
fibre-reinforced Plastics	D Y	D Y		D Y	D Y												

The order in the material groups shows our application recommendation from top to bottom. The optimum suitability for each specific material in your application can only be determined in machining trials.

$$\text{RPM} = \frac{\text{SFM}}{\text{DIAM. in.}} \times 3.82 \quad \text{IPM} = \text{IPR} \times \text{RPM}$$

$$\frac{\text{HOLE DEPTH in.}}{\text{IPM}} \times 60 = \text{Cut Time}$$

$$\text{mm} = \text{in.} \times 25.40$$

$$\text{m/min.} = \text{SFM} \div 3.28$$

$$\text{Bar} = \text{PSI} \div 14.50$$

$$\text{mm/rev.} = \text{IPR} \times 25.40$$

$$\text{Liter} = \text{Gal.} \div 3.79$$

Series # 207

Material group	Hardness	SFM	Feed Rate - IPR											
			1/16 in. 1.590 mm	1/8 in. 3.170 mm	1/4 in. 6.350 mm	3/8 in. 9.520 mm	1/2 in. 12.700 mm	5/8 in. 15.870 mm	3/4 in. 19.050 mm	1 in. 25.400 mm	1 1/4 in. 31.750 mm	1 1/2 in. 38.100 mm		
Common structural steels	≤100 Bhn >100-260 Bhn	•	•	•	•	•	•	•	•	•	•	•	•	•
Free-cutting steels	≤24 Rc >24-30 Rc	•	•	•	•	•	•	•	•	•	•	•	•	•
Unalloyed heat-treatable steels	≤16 Rc 16-24 Rc 24-30 Rc	•	•	•	•	•	•	•	•	•	•	•	•	•
Alloyed heat-treatable steels	24-30 Rc >30-38 Rc	•	•	•	•	•	•	•	•	•	•	•	•	•
Unalloyed case hardened steels	≤230 Bhn	•	•	•	•	•	•	•	•	•	•	•	•	•
Alloyed case hardened steels	24-30 Rc >30-38 Rc	•	•	•	•	•	•	•	•	•	•	•	•	•
Nitriding steels	≥24-30 Rc >30-38 Rc	•	•	•	•	•	•	•	•	•	•	•	•	•
Tool steels	≤24 Rc >24-30 Rc	•	•	•	•	•	•	•	•	•	•	•	•	•
High speed steels	≥14-30 Rc	•	•	•	•	•	•	•	•	•	•	•	•	•
Spring steels	≤330 Bhn	•	•	•	•	•	•	•	•	•	•	•	•	•
Stainless steels, sulphured austenitic	≤24 Rc	•	•	•	•	•	•	•	•	•	•	•	•	•
Stainless steels, sulphured martensitic	≤24 Rc	•	•	•	•	•	•	•	•	•	•	•	•	•
Hardened steels	≤40-48 Rc >48-60 Rc	•	•	•	•	•	•	•	•	•	•	•	•	•
Special alloys	≤38 Rc	•	•	•	•	•	•	•	•	•	•	•	•	•
Cast iron	≤240 Bhn <300 Bhn	•	•	•	•	•	•	•	•	•	•	•	•	•
Spheroidal graphite iron and malleable cast iron	≤240 Bhn <300 Bhn	•	•	•	•	•	•	•	•	•	•	•	•	•
Chilled cast iron	≤350 Bhn	•	•	•	•	•	•	•	•	•	•	•	•	•
Ti and Ti-alloys	≤24 Rc >24-38 Rc	•	•	•	•	•	•	•	•	•	•	•	•	•
Aluminium and Al-alloys	≤120 Bhn	260	0.002	0.0065	0.0100	0.0125	0.0160	0.0160	0.0180	•	•	•	•	•
Al wrought alloys	≤150 Bhn	260	0.002	0.0065	0.0100	0.0125	0.0160	0.0160	0.0180	•	•	•	•	•
Al cast alloys ≤ 10 % Si > 10 % Si	≤200 Bhn ≤200 Bhn	205	0.002	0.0065	0.0100	0.0125	0.0160	0.0160	0.0180	•	•	•	•	•
Magnesium alloys	≤150 Bhn	•	•	•	•	•	•	•	•	•	•	•	•	•
Copper, low-alloyed	≤120 Bhn	100	0.0015	0.0040	0.0065	0.0080	0.0100	0.0100	0.0110	•	•	•	•	•
Brass, short-chipping long-chipping	≤200 Bhn ≤200 Bhn	•	•	•	•	•	•	•	•	•	•	•	•	•
Bronze, short-chipping	≤200 Bhn >200-260 Bhn	•	•	•	•	•	•	•	•	•	•	•	•	•
Bronze, long-chipping	≤24 Rc >24-30 Rc	•	•	•	•	•	•	•	•	•	•	•	•	•
Duroplastics	-	•	•	•	•	•	•	•	•	•	•	•	•	•
Thermoplastics	-	80	0.0015	0.0040	0.0065	0.0080	0.0100	0.0100	0.0110	•	•	•	•	•
Reinforced plastics - Kevlar	-	•	•	•	•	•	•	•	•	•	•	•	•	•
Reinforced plastics - GFK / CFK	-	•	•	•	•	•	•	•	•	•	•	•	•	•

Series # 208

Material group	Hardness	SFM	Feed Rate - IPR											
			1/16 in. 1.590 mm	1/8 in. 3.170 mm	1/4 in. 6.350 mm	3/8 in. 9.520 mm	1/2 in. 12.700 mm	5/8 in. 15.870 mm	3/4 in. 19.050 mm	1 in. 25.400 mm	1 1/4 in. 31.750 mm	1 1/2 in. 38.100 mm		
Common structural steels	≤100 Bhn >100-260 Bhn	100	0.0017	0.005	0.0080	0.0100	0.0125	•	•	•	•	•	•	•
Free-cutting steels	≤24 Rc >24-30 Rc	100	0.0017	0.005	0.0080	0.0100	0.0125	•	•	•	•	•	•	•
Unalloyed heat-treatable steels	≤16 Rc 16-24 Rc 24-30 Rc	100	0.0015	0.004	0.0065	0.0080	0.0100	•	•	•	•	•	•	•
Alloyed heat-treatable steels	24-30 Rc >30-38 Rc	•	•	•	•	•	•	•	•	•	•	•	•	•
Unalloyed case hardened steels	≤230 Bhn	100	0.0017	0.0050	0.0080	0.0100	0.0125	•	•	•	•	•	•	•
Alloyed case hardened steels	24-30 Rc >30-38 Rc	•	•	•	•	•	•	•	•	•	•	•	•	•
Nitriding steels	≥24-30 Rc >30-38 Rc	•	•	•	•	•	•	•	•	•	•	•	•	•
Tool steels	≤24 Rc >24-30 Rc	50	0.0012	0.0030	0.0050	0.0065	0.0080	•	•	•	•	•	•	•
High speed steels	≥14-30 Rc	•	•	•	•	•	•	•	•	•	•	•	•	•
Spring steels	≤330 Bhn	•	•	•	•	•	•	•	•	•	•	•	•	•
Stainless steels, sulphured austenitic	≤24 Rc	•	•	•	•	•	•	•	•	•	•	•	•	•
Stainless steels, sulphured martensitic	≤24 Rc	•	•	•	•	•	•	•	•	•	•	•	•	•
Hardened steels	≤40-48 Rc >48-60 Rc	•	•	•	•	•	•	•	•	•	•	•	•	•
Special alloys	≤38 Rc	•	•	•	•	•	•	•	•	•	•	•	•	•
Cast iron	≤240 Bhn <300 Bhn	100	0.0017	0.005	0.008	0.0100	0.0125	•	•	•	•	•	•	•
Spheroidal graphite iron and malleable cast iron	≤240 Bhn <300 Bhn	90	0.0017	0.005	0.008	0.0100	0.0125	•	•	•	•	•	•	•
Chilled cast iron	≤350 Bhn	•	•	•	•	•	•	•	•	•	•	•	•	•
Ti and Ti-alloys	≤24 Rc >24-38 Rc	•	•	•	•	•	•	•	•	•	•	•	•	•
Aluminium and Al-alloys	≤120 Bhn	•	•	•	•	•	•	•	•	•	•	•	•	•
Al wrought alloys	≤150 Bhn	•	•	•	•	•	•	•	•	•	•	•	•	•
Al cast alloys ≤ 10 % Si > 10 % Si	≤200 Bhn ≤200 Bhn	205	0.0020	0.0065	0.0100	0.0125	0.0160	•	•	•	•	•	•	•
Magnesium alloys	≤150 Bhn	260	0.0017	0.0050	0.0080	0.0100	0.0125	•	•	•	•	•	•	•
Copper, low-alloyed	≤120 Bhn	100	0.0015	0.0040	0.0065	0.0080	0.0100	•	•	•	•	•	•	•
Brass, short-chipping long-chipping	≤200 Bhn ≤200 Bhn	205	0.0015	0.0040	0.0065	0.0080	0.0100	•	•	•	•	•	•	•
Bronze, short-chipping	≤200 Bhn >200-260 Bhn	100	0.0012	0.0030	0.0050	0.0065	0.0080	•	•	•	•	•	•	•
Bronze, long-chipping	≤24 Rc >24-30 Rc	80	0.0012	0.0030	0.0050	0.0065	0.0080	•	•	•	•	•	•	•
Duroplastics	-	50	0.0012	0.0030	0.0050	0.0065	0.0080	•	•	•	•	•	•	•
Thermoplastics	-	80	0.0015	0.0040	0.0065	0.0080	0.0100	•	•	•	•	•	•	•
Reinforced plastics - Kevlar	-	•	•	•	•	•	•	•	•	•	•	•	•	•
Reinforced plastics - GFK / CFK	-	•	•	•	•	•	•	•	•	•	•	•	•	•

Using These Tables. The Speeds & Feeds listed below are conservative recommendations for initial setup. In actual use, depending on the machining environment and workpiece material, significantly higher speeds and feeds may be achievable. Using the below as a starting point, cutting speed/feed can be gradually adjusted upwards until the optimum settings per application are found.
 Questions? Contact us by telephone at (800) 776-6170.

Series # 225

Material group	Hardness	SFM	Feed Rate - IPR										
			1/16 in. 1.590 mm	1/8 in. 3.170 mm	1/4 in. 6.350 mm	3/8 in. 9.520 mm	1/2 in. 12.700 mm	5/8 in. 15.870 mm	3/4 in. 19.050 mm	1 in. 25.400 mm	1 1/4 in. 31.750 mm	1 1/2 in. 38.100 mm	
Common structural steels	≤100 Bhn >100-260 Bhn	• •	• •	• •	• •	• •	• •	• •	• •	• •	• •	• •	• •
Free-cutting steels	≤24 Rc >24-30 Rc	• •	• •	• •	• •	• •	• •	• •	• •	• •	• •	• •	• •
Unalloyed heat-treatable steels	≤16 Rc 16-24 Rc 24-30 Rc	• • •	• • •	• • •	• • •	• • •	• • •	• • •	• • •	• • •	• • •	• • •	• • •
Alloyed heat-treatable steels	24-30 Rc >30-38 Rc	• •	• •	• •	• •	• •	• •	• •	• •	• •	• •	• •	• •
Unalloyed case hardened steels	≤230 Bhn	•	•	•	•	•	•	•	•	•	•	•	•
Alloyed case hardened steels	24-30 Rc >30-38 Rc	• •	• •	• •	• •	• •	• •	• •	• •	• •	• •	• •	• •
Nitriding steels	≥24-30 Rc >30-38 Rc	• •	• •	• •	• •	• •	• •	• •	• •	• •	• •	• •	• •
Tool steels	≤24 Rc >24-30 Rc	• •	• •	• •	• •	• •	• •	• •	• •	• •	• •	• •	• •
High speed steels	≥14-30 Rc	•	•	•	•	•	•	•	•	•	•	•	•
Spring steels	≤330 Bhn	•	•	•	•	•	•	•	•	•	•	•	•
Stainless steels, sulphured austenitic martensitic	≤24 Rc • • •	• • • •	• • • •	• • • •	• • • •	• • • •	• • • •	• • • •	• • • •	• • • •	• • • •	• • • •	• • • •
Hardened steels	≤40-48 Rc >48-60 Rc	• •	• •	• •	• •	• •	• •	• •	• •	• •	• •	• •	• •
Special alloys	≤38 Rc	•	•	•	•	•	•	•	•	•	•	•	•
Cast iron	≤240 Bhn <300 Bhn	• •	• •	• •	• •	• •	• •	• •	• •	• •	• •	• •	• •
Spheroidal graphite iron and malleable cast iron	≤240 Bhn <300 Bhn	• •	• •	• •	• •	• •	• •	• •	• •	• •	• •	• •	• •
Chilled cast iron	≤350 Bhn	•	•	•	•	•	•	•	•	•	•	•	•
Ti and Ti-alloys	≤24 Rc >24-38 Rc	• •	• •	• •	• •	• •	• •	• •	• •	• •	• •	• •	• •
Aluminium and Al-alloys	≤120 Bhn	295	0.0020	0.0065	0.0100	0.0125	0.0160	0.0160	0.0180	0.0200	•	•	•
Al wrought alloys	≤150 Bhn	295	0.0020	0.0065	0.0100	0.0125	0.0160	0.0160	0.0180	0.0200	•	•	•
Al cast alloys ≤ 10 % Si > 10 % Si	≤200 Bhn •	225 •	0.0020 •	0.0065 •	0.0100 •	0.0125 •	0.0160 •	0.0160 •	0.0180 •	0.0200 •	• •	• •	• •
Magnesium alloys	≤150 Bhn	•	•	•	•	•	•	•	•	•	•	•	•
Copper, low-alloyed	≤120 Bhn	115	0.0015	0.0040	0.0065	0.0080	0.0100	0.0100	0.0110	0.0125	•	•	•
Brass, short-chipping long-chipping	≤200 Bhn •	• 145	• 0.0015	• 0.0040	• 0.0065	• 0.0080	• 0.0100	• 0.0100	• 0.0110	• 0.0125	• •	• •	• •
Bronze, short-chipping	≤200 Bhn >200-260 Bhn	• •	• •	• •	• •	• •	• •	• •	• •	• •	• •	• •	• •
Bronze, long-chipping	≤24 Rc >24-30 Rc	• •	• •	• •	• •	• •	• •	• •	• •	• •	• •	• •	• •
Duroplastics	-	•	•	•	•	•	•	•	•	•	•	•	•
Thermoplastics	-	90	0.0015	0.0040	0.0065	0.0080	0.0100	0.0100	0.0110	0.0125	•	•	•
Reinforced plastics - Kevlar	-	•	•	•	•	•	•	•	•	•	•	•	•
Reinforced plastics - GFK / CFK	-	•	•	•	•	•	•	•	•	•	•	•	•

Series # 226

Material group	Hardness	SFM	Feed Rate - IPR										
			0.0039 in. 1.590 mm	0.0063 in. 3.170 mm	1/4 in. 6.350 mm	3/8 in. 9.520 mm	1/2 in. 12.700 mm	5/8 in. 15.870 mm	3/4 in. 19.050 mm	1 in. 25.400 mm	1 1/4 in. 31.750 mm	1 1/2 in. 38.100 mm	
Common structural steels	≤100 Bhn >100-260 Bhn	115 90	0.0017 0.0015	0.0050 0.0040	0.0080 0.0065	0.0100 0.0080	0.0125 0.0100	• •	• •	• •	• •	• •	• •
Free-cutting steels	≤24 Rc >24-30 Rc	115 90	0.0017 0.0015	0.0050 0.0040	0.0080 0.0065	0.0100 0.0080	0.0125 0.0100	• •	• •	• •	• •	• •	• •
Unalloyed heat-treatable steels	≤16 Rc 16-24 Rc 24-30 Rc	115 90 •	0.0015 0.0015 •	0.0040 0.0040 •	0.0065 0.0065 •	0.0080 0.0080 •	0.0100 0.0100 •	• • •	• • •	• • •	• • •	• • •	• • •
Alloyed heat-treatable steels	24-30 Rc >30-38 Rc	• •	• •	• •	• •	• •	• •	• •	• •	• •	• •	• •	• •
Unalloyed case hardened steels	≤230 Bhn	115	0.0017	0.0050	0.0080	0.0100	0.0125	•	•	•	•	•	•
Alloyed case hardened steels	24-30 Rc >30-38 Rc	• •	• •	• •	• •	• •	• •	• •	• •	• •	• •	• •	• •
Nitriding steels	≥24-30 Rc >30-38 Rc	• •	• •	• •	• •	• •	• •	• •	• •	• •	• •	• •	• •
Tool steels	≤24 Rc >24-30 Rc	55 •	0.0012 •	0.0030 •	0.0050 •	0.0065 •	0.0080 •	• •	• •	• •	• •	• •	• •
High speed steels	≥14-30 Rc	•	•	•	•	•	•	•	•	•	•	•	•
Spring steels	≤330 Bhn	•	•	•	•	•	•	•	•	•	•	•	•
Stainless steels, sulphured austenitic martensitic	≤24 Rc • • •	• • • •	• • • •	• • • •	• • • •	• • • •	• • • •	• • • •	• • • •	• • • •	• • • •	• • • •	• • • •
Hardened steels	≤40-48 Rc >48-60 Rc	• •	• •	• •	• •	• •	• •	• •	• •	• •	• •	• •	• •
Special alloys	≤38 Rc	•	•	•	•	•	•	•	•	•	•	•	•
Cast iron	≤240 Bhn <300 Bhn	115 90	0.0017 0.0017	0.0050 0.0050	0.0080 0.0080	0.0100 0.0100	0.0125 0.0125	• •	• •	• •	• •	• •	• •
Spheroidal graphite iron and malleable cast iron	≤240 Bhn <300 Bhn	100 75	0.0017 0.0017	0.0050 0.0050	0.0080 0.0080	0.0100 0.0100	0.0125 0.0125	• •	• •	• •	• •	• •	• •
Chilled cast iron	≤350 Bhn	•	•	•	•	•	•	•	•	•	•	•	•
Ti and Ti-alloys	≤24 Rc >24-38 Rc	• •	• •	• •	• •	• •	• •	• •	• •	• •	• •	• •	• •
Aluminium and Al-alloys	≤120 Bhn	•	•	•	•	•	•	•	•	•	•	•	•
Al wrought alloys	≤150 Bhn	•	•	•	•	•	•	•	•	•	•	•	•
Al cast alloys ≤ 10 % Si > 10 % Si	≤200 Bhn •	225 180	0.0020 0.0017	0.0065 0.0050	0.0100 0.0080	0.0125 0.0100	0.0160 0.0125	• •	• •	• •	• •	• •	• •
Magnesium alloys	≤150 Bhn	295	0.0017	0.0050	0.0080	0.0100	0.0125	•	•	•	•	•	•
Copper, low-alloyed	≤120 Bhn	115	0.0015	0.0040	0.0065	0.0080	0.0100	•	•	•	•	•	•
Brass, short-chipping long-chipping	≤200 Bhn •	• 145	• 0.0015	• 0.0040	• 0.0065	• 0.0080	• 0.0100	• •	• •	• •	• •	• •	• •
Bronze, short-chipping	≤200 Bhn >200-260 Bhn	115 100	0.0012 0.0012	0.0030 0.0030	0.0050 0.0050	0.0065 0.0065	0.0080 0.0080	• •	• •	• •	• •	• •	• •
Bronze, long-chipping	≤24 Rc >24-30 Rc	90 •	0.0012 •	0.0030 •	0.0050 •	0.0065 •	0.0080 •	• •	• •	• •	• •	• •	• •
Duroplastics	-	55	0.0012	0.0030	0.0050	0.0065	0.0080	•	•	•	•	•	•
Thermoplastics	-	90	0.0015	0.0040	0.0065	0.0080	0.0100	•	•	•	•	•	•
Reinforced plastics - Kevlar	-	•	•	•	•	•	•	•	•	•	•	•	•
Reinforced plastics - GFK / CFK	-	•	•	•	•	•	•	•	•	•	•	•	•

$$\text{RPM} = \frac{\text{SFM}}{\text{DIAM. in.}} \times 3.82 \quad \text{IPM} = \text{IPR} \times \text{RPM}$$

$$\frac{\text{HOLE DEPTH in.}}{\text{IPM}} \times 60 = \text{Cut Time}$$

$$\text{mm} = \text{in.} \times 25.40$$

$$\frac{\text{m/min.}}{\text{mm/rev.}} = \frac{\text{SFM}}{\text{IPR} \times 25.40}$$

$$\text{Bar} = \frac{\text{PSI}}{1.450} \quad \text{Liter} = \frac{\text{Gal.}}{3.79}$$

Series # 235

Material group	Hardness	SFM	Feed Rate - IPR										
			1/16 in. 1.590 mm	1/8 in. 3.170 mm	1/4 in. 6.350 mm	3/8 in. 9.520 mm	1/2 in. 12.700 mm	5/8 in. 15.870 mm	3/4 in. 19.050 mm	1 in. 25.400 mm	1 1/4 in. 31.750 mm	1 1/2 in. 38.100 mm	
Common structural steels	≤100 Bhn >100-260 Bhn	70 55	0.0015 0.0012	0.0040 0.0030	0.0065 0.0050	0.0080 0.0065	0.0100 0.0080	•	•	•	•	•	•
Free-cutting steels	≤24 Rc >24-30 Rc	70 55	0.0015 0.0012	0.0040 0.0030	0.0065 0.0050	0.0080 0.0065	0.0100 0.0080	•	•	•	•	•	•
Unalloyed heat-treatable steels	≤16 Rc 16-24 Rc 24-30 Rc	70 55 •	0.0012 0.0012 •	0.0030 0.0030 •	0.0050 0.0050 •	0.0065 0.0065 •	0.0080 0.0080 •	•	•	•	•	•	•
Alloyed heat-treatable steels	24-30 Rc >30-38 Rc	35 •	0.0010 •	0.0025 •	0.0040 •	0.0050 •	0.0065 •	•	•	•	•	•	•
Unalloyed case hardened steels	≤230 Bhn	70	0.0015	0.0040	0.0065	0.0080	0.0100	•	•	•	•	•	•
Alloyed case hardened steels	24-30 Rc >30-38 Rc	30 •	0.0010 •	0.0025 •	0.0040 •	0.0050 •	0.0065 •	•	•	•	•	•	•
Nitriding steels	≥24-30 Rc >30-38 Rc	25 •	0.0010 •	0.0025 •	0.0040 •	0.0050 •	0.0065 •	•	•	•	•	•	•
Tool steels	≤24 Rc >24-30 Rc	35 15	0.0010 0.0007	0.0025 0.0020	0.0040 0.0030	0.0050 0.0040	0.0065 0.0050	•	•	•	•	•	•
High speed steels	≥14-30 Rc	15	0.0007	0.0020	0.0030	0.0040	0.0050	•	•	•	•	•	•
Spring steels	≤330 Bhn	•	•	•	•	•	•	•	•	•	•	•	•
Stainless steels, sulphured austenitic martensitic	≤24 Rc • • • ≤24 Rc	25 • • • •	0.0010 • • • •	0.0025 • • • •	0.0040 • • • •	0.0050 • • • •	0.0065 • • • •	•	•	•	•	•	•
Hardened steels	≤40-48 Rc >48-60 Rc	• •	• •	• •	• •	• •	• •	•	•	•	•	•	•
Special alloys	≤38 Rc	•	•	•	•	•	•	•	•	•	•	•	•
Cast iron	≤240 Bhn <300 Bhn	70 55	0.0015 0.0015	0.0040 0.0040	0.0065 0.0065	0.0080 0.0080	0.0100 0.0100	•	•	•	•	•	•
Spheroidal graphite iron and malleable cast iron	≤240 Bhn <300 Bhn	65 45	0.0015 0.0015	0.0040 0.0040	0.0065 0.0065	0.0080 0.0080	0.0100 0.0100	•	•	•	•	•	•
Chilled cast iron	≤350 Bhn	•	•	•	•	•	•	•	•	•	•	•	•
Ti and Ti-alloys	≤24 Rc >24-38 Rc	• •	• •	• •	• •	• •	• •	•	•	•	•	•	•
Aluminium and Al-alloys	≤120 Bhn	•	•	•	•	•	•	•	•	•	•	•	•
Al wrought alloys	≤150 Bhn	•	•	•	•	•	•	•	•	•	•	•	•
Al cast alloys ≤ 10 % Si > 10 % Si	≤200 Bhn 115	145 115	0.0017 0.0015	0.0050 0.0040	0.0080 0.0065	0.0100 0.0080	0.0125 0.0100	•	•	•	•	•	•
Magnesium alloys	≤150 Bhn	180	0.0015	0.0040	0.0065	0.0080	0.0100	•	•	•	•	•	•
Copper, low-alloyed	≤120 Bhn	70	0.0012	0.0030	0.0050	0.0065	0.0080	•	•	•	•	•	•
Brass, short-chipping long-chipping	≤200 Bhn ≤200 Bhn	145 90	0.0012 0.0012	0.0030 0.0030	0.0050 0.0050	0.0065 0.0065	0.0080 0.0080	•	•	•	•	•	•
Bronze, short-chipping	≤200 Bhn >200-260 Bhn	70 65	0.0010 0.0010	0.0025 0.0025	0.0040 0.0040	0.0050 0.0050	0.0065 0.0065	•	•	•	•	•	•
Bronze, long-chipping	≤24 Rc >24-30 Rc	55 45	0.0010 0.0010	0.0025 0.0025	0.0040 0.0040	0.0050 0.0050	0.0065 0.0065	•	•	•	•	•	•
Duroplastics	—	35	0.0010	0.0025	0.0040	0.0050	0.0065	•	•	•	•	•	•
Thermoplastics	—	55	0.0012	0.0030	0.0050	0.0065	0.0080	•	•	•	•	•	•
Reinforced plastics - Kevlar	—	•	•	•	•	•	•	•	•	•	•	•	•
Reinforced plastics - GFK / CFK	—	•	•	•	•	•	•	•	•	•	•	•	•

Series # 245

Material group	Hardness	SFM	Feed Rate - IPR										
			1/16 in. 1.590 mm	1/8 in. 3.170 mm	1/4 in. 6.350 mm	3/8 in. 9.520 mm	1/2 in. 12.700 mm	5/8 in. 15.870 mm	3/4 in. 19.050 mm	1 in. 25.400 mm	1 1/4 in. 31.750 mm	1 1/2 in. 38.100 mm	
Common structural steels	≤100 Bhn >100-260 Bhn	100 80	• •	0.0050 0.0040	0.0080 0.0065	0.0100 0.0080	0.0125 0.0100	0.0140 0.0110	0.0160 0.0125	0.0200 0.0160	0.0245 0.0200	•	•
Free-cutting steels	≤24 Rc >24-30 Rc	100 80	• •	0.0050 0.0040	0.0080 0.0065	0.0100 0.0080	0.0125 0.0100	0.0140 0.0110	0.0160 0.0125	0.0200 0.0160	0.0245 0.0200	•	•
Unalloyed heat-treatable steels	≤16 Rc 16-24 Rc 24-30 Rc	100 80 •	• • •	0.0040 0.0040 •	0.0065 0.0065 •	0.0080 0.0080 •	0.0100 0.0100 •	0.0110 0.0110 •	0.0125 0.0125 •	0.0160 0.0160 •	0.0200 0.0200 •	•	•
Alloyed heat-treatable steels	24-30 Rc >30-38 Rc	• •	• •	• •	• •	• •	• •	• •	• •	• •	• •	•	•
Unalloyed case hardened steels	≤230 Bhn	100	•	0.0050	0.0080	0.0100	0.0125	0.0140	0.0160	0.0200	0.0245	•	•
Alloyed case hardened steels	24-30 Rc >30-38 Rc	• •	• •	• •	• •	• •	• •	• •	• •	• •	• •	•	•
Nitriding steels	≥24-30 Rc >30-38 Rc	• •	• •	• •	• •	• •	• •	• •	• •	• •	• •	•	•
Tool steels	≤24 Rc >24-30 Rc	50 •	• •	0.0030 •	0.0050 •	0.0065 •	0.0080 •	0.0090 •	0.0100 •	0.0125 •	0.0160 •	•	•
High speed steels	≥14-30 Rc	•	•	•	•	•	•	•	•	•	•	•	•
Spring steels	≤330 Bhn	•	•	•	•	•	•	•	•	•	•	•	•
Stainless steels, sulphured austenitic martensitic	≤24 Rc • • • ≤24 Rc	• • • • •	• • • • •	• • • • •	• • • • •	• • • • •	• • • • •	• • • • •	•	•	•	•	•
Hardened steels	≤40-48 Rc >48-60 Rc	• •	• •	• •	• •	• •	• •	• •	• •	• •	• •	•	•
Special alloys	≤38 Rc	•	•	•	•	•	•	•	•	•	•	•	•
Cast iron	≤240 Bhn <300 Bhn	100 80	• •	0.0050 0.0050	0.0080 0.0080	0.0100 0.0100	0.0125 0.0125	0.0140 0.0140	0.0160 0.0160	0.0200 0.0200	0.0245 0.0245	•	•
Spheroidal graphite iron and malleable cast iron	≤240 Bhn <300 Bhn	90 65	• •	0.0050 0.0050	0.0080 0.0080	0.0100 0.0100	0.0125 0.0125	0.0140 0.0140	0.0160 0.0160	0.0200 0.0200	0.0245 0.0245	•	•
Chilled cast iron	≤350 Bhn	•	•	•	•	•	•	•	•	•	•	•	•
Ti and Ti-alloys	≤24 Rc >24-38 Rc	• •	• •	• •	• •	• •	• •	• •	• •	• •	• •	•	•
Aluminium and Al-alloys	≤120 Bhn	•	•	•	•	•	•	•	•	•	•	•	•
Al wrought alloys	≤150 Bhn	•	•	•	•	•	•	•	•	•	•	•	•
Al cast alloys ≤ 10 % Si > 10 % Si	≤200 Bhn 160	205 160	• •	0.0065 0.0050	0.0100 0.0080	0.0125 0.0100	0.0160 0.0125	0.0180 0.0140	0.0200 0.0160	0.0245 0.0200	0.0290 0.0245	•	•
Magnesium alloys	≤150 Bhn	260	•	0.0050	0.0080	0.0100	0.0125	0.0140	0.0160	0.0200	0.0245	•	•
Copper, low-alloyed	≤120 Bhn	100	•	0.0040	0.0065	0.0080	0.0100	0.0110	0.0125	0.0160	0.0200	•	•
Brass, short-chipping long-chipping	≤200 Bhn ≤200 Bhn	• 130	• •	• 0.0040	• 0.0065	• 0.0080	• 0.0100	• 0.0110	• 0.0125	• 0.0160	• 0.0200	•	•
Bronze, short-chipping	≤200 Bhn	100	•	0.0030	0.0050	0.0065	0.0080	0.0090	0.0100	0.0125	0.0160	•	•
Bronze, long-chipping	>200-260 Bhn	90	•	0.0030	0.0050	0.0065	0.0080	0.0090	0.0100	0.0125	0.0160	•	•
Bronze, long-chipping	≤24 Rc >24-30 Rc	80 •	• •	0.0030 •	0.0050 •	0.0065 •	0.0080 •	0.0090 •	0.0100 •	0.0125 •	0.0160 •	•	•
Duroplastics	—	50	•	0.0030	0.0050	0.0065	0.0080	0.0090	0.0100	0.0125	0.0160	•	•
Thermoplastics	—	80	•	0.0040	0.0065	0.0080	0.0100	0.0110	0.0125	0.0160	0.0200	•	•
Reinforced plastics - Kevlar	—	•	•	•	•	•	•	•	•	•	•	•	•
Reinforced plastics - GFK / CFK	—	•	•	•	•	•	•	•	•	•	•	•	•

Using These Tables. The Speeds & Feeds listed below are conservative recommendations for initial setup. In actual use, depending on the machining environment and workpiece material, significantly higher speeds and feeds may be achievable. Using the below as a starting point, cutting speed/feed can be gradually adjusted upwards until the optimum settings per application are found. Questions? Contact us by telephone at (800) 776-6170.

Series # 257

Material group	Hardness	SFM	Feed Rate - IPR									
			1/16 in. 1.590 mm	1/8 in. 3.170 mm	1/4 in. 6.350 mm	3/8 in. 9.520 mm	1/2 in. 12.700 mm	5/8 in. 15.870 mm	3/4 in. 19.050 mm	1 in. 25.400 mm	1 1/4 in. 31.750 mm	1 1/2 in. 38.100 mm
Common structural steels	≤100 Bhn	90	.	.	.	0.0100	0.0125	0.0125	0.0140	0.0160	0.0200	0.0245
	>100-260 Bhn	70	.	.	.	0.0080	0.0100	0.0100	0.0110	0.0125	0.0160	0.0200
Free-cutting steels	≤24 Rc	90	.	.	.	0.0100	0.0125	0.0125	0.0140	0.0160	0.0200	0.0245
	>24-30 Rc	70	.	.	.	0.0080	0.0100	0.0100	0.0110	0.0125	0.0160	0.0200
Unalloyed heat-treatable steels	≤16 Rc	90	.	.	.	0.0080	0.0100	0.0100	0.0110	0.0125	0.0160	0.0200
	16-24 Rc	70	.	.	.	0.0080	0.0100	0.0100	0.0110	0.0125	0.0160	0.0200
	24-30 Rc
Alloyed heat-treatable steels	24-30 Rc
	>30-38 Rc
Unalloyed case hardened steels	≤230 Bhn	90	.	.	.	0.0100	0.0125	0.0125	0.0140	0.0160	0.0200	0.0245
Alloyed case hardened steels	24-30 Rc
	>30-38 Rc
Nitriding steels	≥24-30 Rc
	>30-38 Rc
Tool steels	≤24 Rc	45	.	.	.	0.0065	0.0080	0.0080	0.0090	0.0100	0.0125	0.0160
	>24-30 Rc
High speed steels	≥14-30 Rc
Spring steels	≤330 Bhn
Stainless steels, sulphured austenitic martensitic	≤24 Rc
	≤24 Rc
	≤24 Rc
Hardened steels	≤40-48 Rc
	>48-60 Rc
Special alloys	≤38 Rc
Cast iron	≤240 Bhn	90	.	.	.	0.0100	0.0125	0.0125	0.0140	0.0160	0.0200	0.0245
	<300 Bhn	70	.	.	.	0.0100	0.0125	0.0125	0.0140	0.0160	0.0200	0.0245
Spheroidal graphite iron and malleable cast iron	≤240 Bhn	70	.	.	.	0.0100	0.0125	0.0125	0.0140	0.0160	0.0200	0.0245
	<300 Bhn	55	.	.	.	0.0100	0.0125	0.0125	0.0140	0.0160	0.0200	0.0245
Chilled cast iron	≤350 Bhn
Ti and Ti-alloys	≤24 Rc
	>24-38 Rc
Aluminium and Al-alloys	≤120 Bhn
Al wrought alloys	≤150 Bhn
Al cast alloys ≤ 10 % Si > 10 % Si	≤200 Bhn	180	.	.	.	0.0125	0.0160	0.0160	0.0180	0.0200	0.0245	0.0290
	≤200 Bhn	145	.	.	.	0.0100	0.0125	0.0125	0.0140	0.0160	0.0200	0.0245
Magnesium alloys	≤150 Bhn	225	.	.	.	0.0100	0.0125	0.0125	0.0140	0.0160	0.0200	0.0245
Copper, low-alloyed	≤120 Bhn	90	.	.	.	0.0080	0.0100	0.0100	0.0110	0.0125	0.0160	0.0200
Brass, short-chipping long-chipping	≤200 Bhn
	≤200 Bhn	110	.	.	.	0.0080	0.0100	0.0100	0.0110	0.0125	0.0160	0.0200
Bronze, short-chipping	≤200 Bhn	90	.	.	.	0.0065	0.0080	0.0080	0.0090	0.0100	0.0125	0.0160
	>200-260 Bhn	70	.	.	.	0.0065	0.0080	0.0080	0.0090	0.0100	0.0125	0.0160
Bronze, long-chipping	≤24 Rc	70	.	.	.	0.0065	0.0080	0.0080	0.0090	0.0100	0.0125	0.0160
	>24-30 Rc
Duroplastics	-	45	.	.	.	0.0065	0.0080	0.0080	0.0090	0.0100	0.0125	0.0160
Thermoplastics	-	70	.	.	.	0.0080	0.0100	0.0100	0.0110	0.0125	0.0160	0.0200
Reinforced plastics - Kevlar	-
Reinforced plastics - GFK / CFK	-

Series # 266

Material group	Hardness	SFM	Feed Rate - IPR									
			1/16 in. 1.590 mm	1/8 in. 3.170 mm	1/4 in. 6.350 mm	3/8 in. 9.520 mm	1/2 in. 12.700 mm	5/8 in. 15.870 mm	3/4 in. 19.050 mm	1 in. 25.400 mm	1 1/4 in. 31.750 mm	1 1/2 in. 38.100 mm
Common structural steels	≤100 Bhn	70	.	.	.	0.0080	0.0100	0.0100	0.0110	0.0125	0.0160	.
	>100-260 Bhn	55	.	.	.	0.0065	0.0080	0.0080	0.0090	0.0100	0.0125	.
Free-cutting steels	≤24 Rc	70	.	.	.	0.0080	0.0100	0.0100	0.0110	0.0125	0.0160	.
	>24-30 Rc	55	.	.	.	0.0065	0.0080	0.0080	0.0090	0.0100	0.0125	.
Unalloyed heat-treatable steels	≤16 Rc	70	.	.	.	0.0065	0.0080	0.0080	0.0090	0.0100	0.0125	.
	16-24 Rc	55	.	.	.	0.0065	0.0080	0.0080	0.0090	0.0100	0.0125	.
	24-30 Rc
Alloyed heat-treatable steels	24-30 Rc	35	.	.	.	0.0050	0.0065	0.0065	0.0070	0.0080	0.0100	.
	>30-38 Rc
Unalloyed case hardened steels	≤230 Bhn	70	.	.	.	0.0080	0.0100	0.0100	0.0110	0.0125	0.0160	.
Alloyed case hardened steels	24-30 Rc	30	.	.	.	0.0050	0.0065	0.0065	0.0070	0.0080	0.0100	.
	>30-38 Rc
Nitriding steels	≥24-30 Rc	25	.	.	.	0.0050	0.0065	0.0065	0.0070	0.0080	0.0100	.
	>30-38 Rc
Tool steels	≤24 Rc	35	.	.	.	0.0050	0.0065	0.0065	0.0070	0.0080	0.0100	.
	>24-30 Rc	15	.	.	.	0.0040	0.0050	0.0050	0.0055	0.0065	0.0080	.
High speed steels	≥14-30 Rc	15	.	.	.	0.0040	0.0050	0.0050	0.0055	0.0065	0.0080	.
Spring steels	≤330 Bhn
Stainless steels, sulphured austenitic martensitic	≤24 Rc	25	.	.	.	0.0050	0.0065	0.0065	0.0070	0.0080	0.0100	.
	≤24 Rc
	≤24 Rc
Hardened steels	≤40-48 Rc
	>48-60 Rc
Special alloys	≤38 Rc
Cast iron	≤240 Bhn	70	.	.	.	0.0080	0.0100	0.0100	0.0110	0.0125	0.0160	.
	<300 Bhn	55	.	.	.	0.0080	0.0100	0.0100	0.0110	0.0125	0.0160	.
Spheroidal graphite iron and malleable cast iron	≤240 Bhn	65	.	.	.	0.0080	0.0100	0.0100	0.0110	0.0125	0.0160	.
	<300 Bhn	45	.	.	.	0.0080	0.0100	0.0100	0.0110	0.0125	0.0160	.
Chilled cast iron	≤350 Bhn
Ti and Ti-alloys	≤24 Rc
	>24-38 Rc
Aluminium and Al-alloys	≤120 Bhn
Al wrought alloys	≤150 Bhn
Al cast alloys ≤ 10 % Si > 10 % Si	≤200 Bhn	145	.	.	.	0.0100	0.0125	0.0125	0.0140	0.0160	0.0200	.
	≤200 Bhn	115	.	.	.	0.0080	0.0100	0.0100	0.0110	0.0125	0.0160	.
Magnesium alloys	≤150 Bhn	180	.	.	.	0.0080	0.0100	0.0100	0.0110	0.0125	0.0160	.
Copper, low-alloyed	≤120 Bhn	70	.	.	.	0.0065	0.0080	0.0080	0.0090	0.0100	0.0125	.
Brass, short-chipping long-chipping	≤200 Bhn	145	.	.	.	0.0065	0.0080	0.0080	0.0090	0.0100	0.0125	.
	≤200 Bhn	90	.	.	.	0.0065	0.0080	0.0080	0.0090	0.0100	0.0125	.
Bronze, short-chipping	≤200 Bhn	70	.	.	.	0.0050	0.0065	0.0065	0.0070	0.0080	0.0100	.
	>200-260 Bhn	65	.	.	.	0.0050	0.0065	0.0065	0.0070	0.0080	0.0100	.
Bronze, long-chipping	≤24 Rc	55	.	.	.	0.0050	0.0065	0.0065	0.0070	0.0080	0.0100	.
	>24-30 Rc	45	.	.	.	0.0050	0.0065	0.0065	0.0070	0.0080	0.0100	.
Duroplastics	-	35	.	.	.	0.0050	0.0065	0.0065	0.0070	0.0080	0.0100	.
Thermoplastics	-	55	.	.	.	0.0065	0.0080	0.0080	0.0090	0.0100	0.0125	.
Reinforced plastics - Kevlar	-
Reinforced plastics - GFK / CFK	-

$$\text{RPM} = \frac{\text{SFM}}{\text{DIAM. in.}} \times 3.82 \quad \text{IPM} = \text{IPR} \times \text{RPM}$$

$$\frac{\text{HOLE DEPTH in.}}{\text{IPM}} \times 60 = \text{Cut Time}$$

$$\text{mm} = \text{in.} \times 25.40$$

$$\text{m/min.} = \text{SFM} \div 3.28$$

$$\text{mm/rev.} = \text{IPR} \times 25.40$$

$$\text{Bar} = \text{PSI} \div 14.50$$

$$\text{Liter} = \text{Gal.} \div 3.79$$

Series # 390

Material group	Hardness	SFM	Feed Rate - IPR												
			1/16 in. 1.590 mm	1/8 in. 3.170 mm	1/4 in. 6.350 mm	3/8 in. 9.520 mm	1/2 in. 12.700 mm	5/8 in. 15.870 mm	3/4 in. 19.050 mm	1 in. 25.400 mm	1 1/4 in. 31.750 mm	1 1/2 in. 38.100 mm			
Common structural steels	≤100 Bhn >100-260 Bhn	130 95	•	•	•	•	•	•	•	•	•	•	•	•	•
Free-cutting steels	≤24 Rc >24-30 Rc	130 95	•	•	•	•	•	•	•	•	•	•	•	•	•
Unalloyed heat-treatable steels	≤16 Rc 16-24 Rc 24-30 Rc	130 95 70	•	•	•	•	•	•	•	•	•	•	•	•	•
Alloyed heat-treatable steels	24-30 Rc >30-38 Rc	65 45	•	•	•	•	•	•	•	•	•	•	•	•	•
Unalloyed case hardened steels	≤230 Bhn	130	•	•	•	•	•	•	•	•	•	•	•	•	•
Alloyed case hardened steels	24-30 Rc >30-38 Rc	55 35	•	•	•	•	•	•	•	•	•	•	•	•	•
Nitriding steels	≥24-30 Rc >30-38 Rc	45 30	•	•	•	•	•	•	•	•	•	•	•	•	•
Tool steels	≤24 Rc >24-30 Rc	65 30	•	•	•	•	•	•	•	•	•	•	•	•	•
High speed steels	≥14-30 Rc	30	•	•	•	•	•	•	•	•	•	•	•	•	•
Spring steels	≤330 Bhn	20	•	•	•	•	•	•	•	•	•	•	•	•	•
Stainless steels, sulphured	≤24 Rc	45	•	•	•	•	•	•	•	•	•	•	•	•	•
austenitic	≤24 Rc	30	•	•	•	•	•	•	•	•	•	•	•	•	•
martensitic	≤24 Rc	35	•	•	•	•	•	•	•	•	•	•	•	•	•
Hardened steels	≤40-48 Rc >48-60 Rc	10 •	•	•	•	•	•	•	•	•	•	•	•	•	•
Special alloys	≤38 Rc	15	•	•	•	•	•	•	•	•	•	•	•	•	•
Cast iron	≤240 Bhn <300 Bhn	130 95	•	•	•	•	•	•	•	•	•	•	•	•	•
Spheroidal graphite iron and malleable cast iron	≤240 Bhn <300 Bhn	110 80	•	•	•	•	•	•	•	•	•	•	•	•	•
Chilled cast iron	≤350 Bhn	20	•	•	•	•	•	•	•	•	•	•	•	•	•
Ti and Ti-alloys	≤24 Rc >24-38 Rc	30 15	•	•	•	•	•	•	•	•	•	•	•	•	•
Aluminium and Al-alloys	≤120 Bhn	•	•	•	•	•	•	•	•	•	•	•	•	•	•
Al wrought alloys	≤150 Bhn	•	•	•	•	•	•	•	•	•	•	•	•	•	•
Al cast alloys ≤ 10 % Si	≤200 Bhn	245	•	•	•	•	•	•	•	•	•	•	•	•	•
> 10 % Si	≤200 Bhn	195	•	•	•	•	•	•	•	•	•	•	•	•	•
Magnesium alloys	≤150 Bhn	•	•	•	•	•	•	•	•	•	•	•	•	•	•
Copper, low-alloyed	≤120 Bhn	130	•	•	•	•	•	•	•	•	•	•	•	•	•
Brass, short-chipping	≤200 Bhn	•	•	•	•	•	•	•	•	•	•	•	•	•	•
long-chipping	≤200 Bhn	160	•	•	•	•	•	•	•	•	•	•	•	•	•
Bronze, short-chipping	≤200 Bhn	•	•	•	•	•	•	•	•	•	•	•	•	•	•
>200-260 Bhn	110	•	•	•	•	•	•	•	•	•	•	•	•	•	•
Bronze, long-chipping	≤24 Rc >24-30 Rc	95 80	•	•	•	•	•	•	•	•	•	•	•	•	•
Duroplastics	-	•	•	•	•	•	•	•	•	•	•	•	•	•	•
Thermoplastics	-	95	•	•	•	•	•	•	•	•	•	•	•	•	•
Reinforced plastics - Kevlar	-	•	•	•	•	•	•	•	•	•	•	•	•	•	•
Reinforced plastics - GFK / CFK	-	•	•	•	•	•	•	•	•	•	•	•	•	•	•

Series # 501

Material group	Hardness	SFM	Feed Rate - IPR												
			1/16 in. 1.590 mm	1/8 in. 3.170 mm	1/4 in. 6.350 mm	3/8 in. 9.520 mm	1/2 in. 12.700 mm	5/8 in. 15.870 mm	3/4 in. 19.050 mm	1 in. 25.400 mm	1 1/4 in. 31.750 mm	1 1/2 in. 38.100 mm			
Common structural steels	≤100 Bhn >100-260 Bhn	•	•	•	•	•	•	•	•	•	•	•	•	•	•
Free-cutting steels	≤24 Rc >24-30 Rc	•	•	•	•	•	•	•	•	•	•	•	•	•	•
Unalloyed heat-treatable steels	≤16 Rc 16-24 Rc 24-30 Rc	•	•	•	•	•	•	•	•	•	•	•	•	•	•
Alloyed heat-treatable steels	24-30 Rc >30-38 Rc	•	•	•	•	•	•	•	•	•	•	•	•	•	•
Unalloyed case hardened steels	≤230 Bhn	•	•	•	•	•	•	•	•	•	•	•	•	•	•
Alloyed case hardened steels	24-30 Rc >30-38 Rc	•	•	•	•	•	•	•	•	•	•	•	•	•	•
Nitriding steels	≥24-30 Rc >30-38 Rc	•	•	•	•	•	•	•	•	•	•	•	•	•	•
Tool steels	≤24 Rc >24-30 Rc	•	•	•	•	•	•	•	•	•	•	•	•	•	•
High speed steels	≥14-30 Rc	•	•	•	•	•	•	•	•	•	•	•	•	•	•
Spring steels	≤330 Bhn	•	•	•	•	•	•	•	•	•	•	•	•	•	•
Stainless steels, sulphured	≤24 Rc	•	•	•	•	•	•	•	•	•	•	•	•	•	•
austenitic	≤24 Rc	•	•	•	•	•	•	•	•	•	•	•	•	•	•
martensitic	≤24 Rc	•	•	•	•	•	•	•	•	•	•	•	•	•	•
Hardened steels	≤40-48 Rc >48-60 Rc	•	•	•	•	•	•	•	•	•	•	•	•	•	•
Special alloys	≤38 Rc	•	•	•	•	•	•	•	•	•	•	•	•	•	•
Cast iron	≤240 Bhn <300 Bhn	•	•	•	•	•	•	•	•	•	•	•	•	•	•
Spheroidal graphite iron and malleable cast iron	≤240 Bhn <300 Bhn	•	•	•	•	•	•	•	•	•	•	•	•	•	•
Chilled cast iron	≤350 Bhn	•	•	•	•	•	•	•	•	•	•	•	•	•	•
Ti and Ti-alloys	≤24 Rc >24-38 Rc	•	•	•	•	•	•	•	•	•	•	•	•	•	•
Aluminium and Al-alloys	≤120 Bhn	225	0.0020	0.0065	0.0100	0.0125	0.0160	0.0160	•	•	•	•	•	•	•
Al wrought alloys	≤150 Bhn	225	0.0020	0.0065	0.0100	0.0125	0.0160	0.0160	•	•	•	•	•	•	•
Al cast alloys ≤ 10 % Si	≤200 Bhn	•	•	•	•	•	•	•	•	•	•	•	•	•	•
> 10 % Si	≤200 Bhn	•	•	•	•	•	•	•	•	•	•	•	•	•	•
Magnesium alloys	≤150 Bhn	225	0.0017	0.0050	0.0080	0.0100	0.0125	0.0125	•	•	•	•	•	•	•
Copper, low-alloyed	≤120 Bhn	130	0.0020	0.0065	0.0100	0.0125	0.0160	0.0160	•	•	•	•	•	•	•
Brass, short-chipping	≤200 Bhn	•	•	•	•	•	•	•	•	•	•	•	•	•	•
long-chipping	≤200 Bhn	•	•	•	•	•	•	•	•	•	•	•	•	•	•
Bronze, short-chipping	≤200 Bhn	•	•	•	•	•	•	•	•	•	•	•	•	•	•
>200-260 Bhn	•	•	•	•	•	•	•	•	•	•	•	•	•	•	•
Bronze, long-chipping	≤24 Rc >24-30 Rc	•	•	•	•	•	•	•	•	•	•	•	•	•	•
Duroplastics	-	•	•	•	•	•	•	•	•	•	•	•	•	•	•
Thermoplastics	-	70	0.0015	0.0040	0.0065	0.0080	0.0100	0.0100	•	•	•	•	•	•	•
Reinforced plastics - Kevlar	-	•	•	•	•	•	•	•	•	•	•	•	•	•	•
Reinforced plastics - GFK / CFK	-	•	•	•	•	•	•	•	•	•	•	•	•	•	•

$$\text{RPM} = \frac{\text{SFM}}{\text{DIAM. in.}} \times 3.82 \quad \text{IPM} = \text{IPR} \times \text{RPM}$$

$$\frac{\text{HOLE DEPTH in.}}{\text{IPM}} \times 60 = \text{Cut Time}$$

$$\text{mm} = \text{in.} \times 25.40$$

$$\text{m/min.} = \text{SFM} \div 3.28$$

$$\text{mm/rev.} = \text{IPR} \times 25.40$$

$$\text{Bar} = \text{PSI} \div 14.50$$

$$\text{Liter} = \text{Gal.} \div 3.79$$

Series # 504

Material group	Hardness	SFM	Feed Rate - IPR										
			1/16 in. 1.590 mm	1/8 in. 3.170 mm	1/4 in. 6.350 mm	3/8 in. 9.520 mm	1/2 in. 12.700 mm	5/8 in. 15.870 mm	3/4 in. 19.050 mm	1 in. 25.400 mm	1 1/4 in. 31.750 mm	1 1/2 in. 38.100 mm	
Common structural steels	≤100 Bhn >100-260 Bhn	70 55	•	0.0040	0.0065	0.0080	0.0100	•	•	•	•	•	•
Free-cutting steels	≤24 Rc >24-30 Rc	70 55	•	0.0040	0.0050	0.0065	0.0080	•	•	•	•	•	•
Unalloyed heat-treatable steels	≤16 Rc 16-24 Rc 24-30 Rc	70 55 •	•	0.0030	0.0050	0.0065	0.0080	•	•	•	•	•	•
Alloyed heat-treatable steels	24-30 Rc >30-38 Rc	35 •	•	0.0025	0.0040	0.0050	0.0065	•	•	•	•	•	•
Unalloyed case hardened steels	≤230 Bhn	70	•	0.0040	0.0065	0.0080	0.0100	•	•	•	•	•	•
Alloyed case hardened steels	24-30 Rc >30-38 Rc	30 •	•	0.0025	0.0040	0.0050	0.0065	•	•	•	•	•	•
Nitriding steels	≥24-30 Rc >30-38 Rc	25 •	•	0.0025	0.0040	0.0050	0.0065	•	•	•	•	•	•
Tool steels	≤24 Rc >24-30 Rc	35 15	•	0.0025	0.0040	0.0050	0.0065	•	•	•	•	•	•
High speed steels	≥14-30 Rc	15	•	0.0020	0.0030	0.0040	0.0050	•	•	•	•	•	•
Spring steels	≤330 Bhn	•	•	•	•	•	•	•	•	•	•	•	•
Stainless steels, sulphured austenitic martensitic	≤24 Rc • • • • •	25 • • • • •	•	0.0025	0.0040	0.0050	0.0065	•	•	•	•	•	•
Hardened steels	≤40-48 Rc >48-60 Rc	• •	•	•	•	•	•	•	•	•	•	•	•
Special alloys	≤38 Rc	•	•	•	•	•	•	•	•	•	•	•	•
Cast iron	≤240 Bhn <300 Bhn	70 55	•	0.0040	0.0065	0.0080	0.0100	•	•	•	•	•	•
Spheroidal graphite iron and malleable cast iron	≤240 Bhn <300 Bhn	65 45	•	0.0040	0.0065	0.0080	0.0100	•	•	•	•	•	•
Chilled cast iron	≤350 Bhn	•	•	•	•	•	•	•	•	•	•	•	•
Ti and Ti-alloys	≤24 Rc >24-38 Rc	• •	•	•	•	•	•	•	•	•	•	•	•
Aluminium and Al-alloys	≤120 Bhn	•	•	•	•	•	•	•	•	•	•	•	•
Al wrought alloys	≤150 Bhn	•	•	•	•	•	•	•	•	•	•	•	•
Al cast alloys ≤ 10 % Si > 10 % Si	≤200 Bhn 115	145 •	•	0.0050	0.0080	0.0100	0.0125	•	•	•	•	•	•
Magnesium alloys	≤150 Bhn	180	•	0.0040	0.0065	0.0080	0.0100	•	•	•	•	•	•
Copper, low-alloyed	≤120 Bhn	70	•	0.0030	0.0050	0.0065	0.0080	•	•	•	•	•	•
Brass, short-chipping long-chipping	≤200 Bhn • • •	• • 90 •	•	•	•	•	•	•	•	•	•	•	•
Bronze, short-chipping	≤200 Bhn >200-260 Bhn	70 65	•	0.0025	0.0040	0.0050	0.0065	•	•	•	•	•	•
Bronze, long-chipping	≤24 Rc >24-30 Rc	55 •	•	0.0025	0.0040	0.0050	0.0065	•	•	•	•	•	•
Duroplastics	-	35	•	0.0025	0.0040	0.0050	0.0065	•	•	•	•	•	•
Thermoplastics	-	55	•	0.0030	0.0050	0.0065	0.0080	•	•	•	•	•	•
Reinforced plastics - Kevlar	-	•	•	•	•	•	•	•	•	•	•	•	•
Reinforced plastics - GFK / CFK	-	•	•	•	•	•	•	•	•	•	•	•	•

Series # 515

Material group	Hardness	SFM	Feed Rate - IPR										
			1/16 in. 1.590 mm	1/8 in. 3.170 mm	1/4 in. 6.350 mm	3/8 in. 9.520 mm	1/2 in. 12.700 mm	5/8 in. 15.870 mm	3/4 in. 19.050 mm	1 in. 25.400 mm	1 1/4 in. 31.750 mm	1 1/2 in. 38.100 mm	
Common structural steels	≤100 Bhn >100-260 Bhn	160 130	0.0017	0.0050	0.0080	0.0100	0.0125	0.0125	•	•	•	•	•
Free-cutting steels	≤24 Rc >24-30 Rc	195 160	0.0017	0.0050	0.0080	0.0100	0.0125	0.0125	•	•	•	•	•
Unalloyed heat-treatable steels	≤16 Rc 16-24 Rc 24-30 Rc	130 130 100	0.0017	0.0050	0.0080	0.0100	0.0125	0.0125	•	•	•	•	•
Alloyed heat-treatable steels	24-30 Rc >30-38 Rc	100 100	0.0012	0.0030	0.0050	0.0065	0.0080	0.0080	•	•	•	•	•
Unalloyed case hardened steels	≤230 Bhn	130	0.0010	0.0025	0.0040	0.0050	0.0065	0.0065	•	•	•	•	•
Alloyed case hardened steels	24-30 Rc >30-38 Rc	80 65	0.0012	0.0030	0.0050	0.0065	0.0080	0.0080	•	•	•	•	•
Nitriding steels	≥24-30 Rc >30-38 Rc	65 65	0.0012	0.0030	0.0050	0.0065	0.0080	0.0080	•	•	•	•	•
Tool steels	≤24 Rc >24-30 Rc	80 65	0.0012	0.0030	0.0050	0.0065	0.0080	0.0080	•	•	•	•	•
High speed steels	≥14-30 Rc	65	0.0010	0.0025	0.0040	0.0050	0.0065	0.0065	•	•	•	•	•
Spring steels	≤330 Bhn	35	0.0007	0.0020	0.0030	0.0040	0.0050	0.0050	•	•	•	•	•
Stainless steels, sulphured austenitic martensitic	≤24 Rc • • • • •	65 45 • • 65 •	0.0012	0.0030	0.0050	0.0065	0.0080	0.0080	•	•	•	•	•
Hardened steels	≤40-48 Rc >48-60 Rc	• •	•	•	•	•	•	•	•	•	•	•	•
Special alloys	≤38 Rc	40	0.0007	0.0020	0.0030	0.0040	0.0050	0.0050	•	•	•	•	•
Cast iron	≤240 Bhn <300 Bhn	145 115	0.0017	0.0050	0.0080	0.0100	0.0125	0.0125	•	•	•	•	•
Spheroidal graphite iron and malleable cast iron	≤240 Bhn <300 Bhn	130 100	0.0017	0.0050	0.0080	0.0100	0.0125	0.0125	•	•	•	•	•
Chilled cast iron	≤350 Bhn	•	•	•	•	•	•	•	•	•	•	•	•
Ti and Ti-alloys	≤24 Rc >24-38 Rc	• •	•	•	•	•	•	•	•	•	•	•	•
Aluminium and Al-alloys	≤120 Bhn	•	•	•	•	•	•	•	•	•	•	•	•
Al wrought alloys	≤150 Bhn	•	•	•	•	•	•	•	•	•	•	•	•
Al cast alloys ≤ 10 % Si > 10 % Si	≤200 Bhn 260	295 •	0.0020	0.0065	0.0100	0.0125	0.0160	0.0160	•	•	•	•	•
Magnesium alloys	≤150 Bhn	260	0.0017	0.0050	0.0080	0.0100	0.0125	0.0125	•	•	•	•	•
Copper, low-alloyed	≤120 Bhn	•	•	•	•	•	•	•	•	•	•	•	•
Brass, short-chipping long-chipping	≤200 Bhn • • •	• • • •	•	•	•	•	•	•	•	•	•	•	•
Bronze, short-chipping	≤200 Bhn >200-260 Bhn	• •	•	•	•	•	•	•	•	•	•	•	•
Bronze, long-chipping	≤24 Rc >24-30 Rc	• •	•	•	•	•	•	•	•	•	•	•	•
Duroplastics	-	•	•	•	•	•	•	•	•	•	•	•	•
Thermoplastics	-	•	•	•	•	•	•	•	•	•	•	•	•
Reinforced plastics - Kevlar	-	•	•	•	•	•	•	•	•	•	•	•	•
Reinforced plastics - GFK / CFK	-	•	•	•	•	•	•	•	•	•	•	•	•

Using These Tables. The Speeds & Feeds listed below are conservative recommendations for initial setup. In actual use, depending on the machining environment and workpiece material, significantly higher speeds and feeds may be achievable. Using the below as a starting point, cutting speed/feed can be gradually adjusted upwards until the optimum settings per application are found.
 Questions? Contact us by telephone at (800) 776-6170.

Series # 524

Material group	Hardness	SFM	Feed Rate - IPR											
			1/16 in. 1.590 mm	1/8 in. 3.170 mm	1/4 in. 6.350 mm	3/8 in. 9.520 mm	1/2 in. 12.700 mm	5/8 in. 15.870 mm	3/4 in. 19.050 mm	1 in. 25.400 mm	1 1/4 in. 31.750 mm	1 1/2 in. 38.100 mm		
Common structural steels	≤100 Bhn >100-260 Bhn	•	•	•	•	•	•	•	•	•	•	•	•	•
Free-cutting steels	≤24 Rc >24-30 Rc	•	•	•	•	•	•	•	•	•	•	•	•	•
Unalloyed heat-treatable steels	≤16 Rc 16-24 Rc 24-30 Rc	•	•	•	•	•	•	•	•	•	•	•	•	•
Alloyed heat-treatable steels	24-30 Rc >30-38 Rc	•	•	•	•	•	•	•	•	•	•	•	•	•
Unalloyed case hardened steels	≤230 Bhn	•	•	•	•	•	•	•	•	•	•	•	•	•
Alloyed case hardened steels	24-30 Rc >30-38 Rc	•	•	•	•	•	•	•	•	•	•	•	•	•
Nitriding steels	≥24-30 Rc >30-38 Rc	•	•	•	•	•	•	•	•	•	•	•	•	•
Tool steels	≤24 Rc >24-30 Rc	•	•	•	•	•	•	•	•	•	•	•	•	•
High speed steels	≥14-30 Rc	•	•	•	•	•	•	•	•	•	•	•	•	•
Spring steels	≤330 Bhn	•	•	•	•	•	•	•	•	•	•	•	•	•
Stainless steels, sulphured austenitic martensitic	≤24 Rc • •	•	•	•	•	•	•	•	•	•	•	•	•	•
Hardened steels	≤40-48 Rc >48-60 Rc	•	•	•	•	•	•	•	•	•	•	•	•	•
Special alloys	≤38 Rc	•	•	•	•	•	•	•	•	•	•	•	•	•
Cast iron	≤240 Bhn • •	•	•	•	•	•	•	•	•	•	•	•	•	•
Spheroidal graphite iron and malleable cast iron	≤240 Bhn <300 Bhn	•	•	•	•	•	•	•	•	•	•	•	•	•
Chilled cast iron	≤350 Bhn	•	•	•	•	•	•	•	•	•	•	•	•	•
Ti and Ti-alloys	≤24 Rc >24-38 Rc	•	•	•	•	•	•	•	•	•	•	•	•	•
Aluminium and Al-alloys	≤120 Bhn	180	0.0017	0.0050	0.0080	0.0100	0.0125	•	•	•	•	•	•	•
Al wrought alloys	≤150 Bhn	180	0.0017	0.0050	0.0080	0.0100	0.0125	•	•	•	•	•	•	•
Al cast alloys ≤ 10 % Si > 10 % Si	≤200 Bhn •	•	•	•	•	•	•	•	•	•	•	•	•	•
Magnesium alloys	≤150 Bhn	180	0.0015	0.0040	0.0065	0.0080	0.0100	•	•	•	•	•	•	•
Copper, low-alloyed	≤120 Bhn	105	0.0017	0.0050	0.0080	0.0100	0.0125	•	•	•	•	•	•	•
Brass, short-chipping long-chipping	≤200 Bhn •	•	•	•	•	•	•	•	•	•	•	•	•	•
Bronze, short-chipping	≤200 Bhn •	•	•	•	•	•	•	•	•	•	•	•	•	•
Bronze, long-chipping	>200-260 Bhn •	•	•	•	•	•	•	•	•	•	•	•	•	•
Duroplastics Thermoplastics	- •	55	0.0012	0.0030	0.0050	0.0065	0.0080	•	•	•	•	•	•	•
Reinforced plastics - Kevlar Reinforced plastics - GFK / CFK	- •	•	•	•	•	•	•	•	•	•	•	•	•	•

Series # 526

Material group	Hardness	SFM	Feed Rate - IPR												
			1/16 in. 1.590 mm	1/8 in. 3.170 mm	1/4 in. 6.350 mm	3/8 in. 9.520 mm	1/2 in. 12.700 mm	5/8 in. 15.870 mm	3/4 in. 19.050 mm	1 in. 25.400 mm	1 1/4 in. 31.750 mm	1 1/2 in. 38.100 mm			
Common structural steels	≤100 Bhn >100-260 Bhn	70	•	•	•	•	0.0100	0.0100	0.0100	0.0110	0.0125	•	•	•	•
Free-cutting steels	≤24 Rc >24-30 Rc	70	•	•	•	•	0.0080	0.0080	0.0100	0.0110	0.0125	•	•	•	•
Unalloyed heat-treatable steels	≤16 Rc 16-24 Rc 24-30 Rc	70	•	•	•	•	0.0065	0.0080	0.0080	0.0090	0.0100	•	•	•	•
Alloyed heat-treatable steels	24-30 Rc >30-38 Rc	35	•	•	•	•	0.0050	0.0065	0.0065	0.0070	0.0080	•	•	•	•
Unalloyed case hardened steels	≤230 Bhn	70	•	•	•	•	0.0080	0.0100	0.0100	0.0110	0.0125	•	•	•	•
Alloyed case hardened steels	24-30 Rc >30-38 Rc	30	•	•	•	•	0.0050	0.0065	0.0065	0.0070	0.0080	•	•	•	•
Nitriding steels	≥24-30 Rc >30-38 Rc	25	•	•	•	•	0.0050	0.0065	0.0065	0.0070	0.0080	•	•	•	•
Tool steels	≤24 Rc >24-30 Rc	35	•	•	•	•	0.0050	0.0065	0.0065	0.0070	0.0080	•	•	•	•
High speed steels	≥14-30 Rc	15	•	•	•	•	0.0040	0.0050	0.0050	0.0055	0.0065	•	•	•	•
Spring steels	≤330 Bhn	•	•	•	•	•	•	•	•	•	•	•	•	•	•
Stainless steels, sulphured austenitic martensitic	≤24 Rc • •	25	•	•	•	•	0.0050	0.0065	0.0065	0.0070	0.0080	•	•	•	•
Hardened steels	≤40-48 Rc >48-60 Rc	•	•	•	•	•	•	•	•	•	•	•	•	•	•
Special alloys	≤38 Rc	•	•	•	•	•	•	•	•	•	•	•	•	•	•
Cast iron	≤240 Bhn • •	70	•	•	•	•	0.0080	0.0100	0.0100	0.0110	0.0125	•	•	•	•
Spheroidal graphite iron and malleable cast iron	≤240 Bhn <300 Bhn	65	•	•	•	•	0.0080	0.0100	0.0100	0.0110	0.0125	•	•	•	•
Chilled cast iron	≤350 Bhn	45	•	•	•	•	0.0080	0.0100	0.0100	0.0110	0.0125	•	•	•	•
Ti and Ti-alloys	≤24 Rc >24-38 Rc	•	•	•	•	•	•	•	•	•	•	•	•	•	•
Aluminium and Al-alloys	≤120 Bhn	•	•	•	•	•	•	•	•	•	•	•	•	•	•
Al wrought alloys	≤150 Bhn	•	•	•	•	•	•	•	•	•	•	•	•	•	•
Al cast alloys ≤ 10 % Si > 10 % Si	≤200 Bhn •	145	•	•	•	•	0.0100	0.0125	0.0125	0.0140	0.0160	•	•	•	•
Magnesium alloys	≤150 Bhn	115	•	•	•	•	0.0080	0.0100	0.0100	0.0110	0.0125	•	•	•	•
Copper, low-alloyed	≤120 Bhn	180	•	•	•	•	0.0080	0.0100	0.0100	0.0110	0.0125	•	•	•	•
Brass, short-chipping long-chipping	≤200 Bhn •	70	•	•	•	•	0.0065	0.0080	0.0080	0.0090	0.0100	•	•	•	•
Bronze, short-chipping	≤200 Bhn •	90	•	•	•	•	0.0065	0.0080	0.0080	0.0090	0.0100	•	•	•	•
Bronze, long-chipping	>200-260 Bhn •	70	•	•	•	•	0.0050	0.0065	0.0065	0.0070	0.0080	•	•	•	•
Duroplastics Thermoplastics	- •	65	•	•	•	•	0.0050	0.0065	0.0065	0.0070	0.0080	•	•	•	•
Reinforced plastics - Kevlar Reinforced plastics - GFK / CFK	- •	55	•	•	•	•	0.0050	0.0065	0.0065	0.0070	0.0080	•	•	•	•

RPM = $\frac{\text{SFM}}{\text{DIAM. in.}} \times 3.82$ IPM = IPR x RPM

HOLE DEPTH in. x 60 = Cut Time
IPM

m/min. = SFM ÷ 3.28
mm/rev. = IPR x 25.40

Bar = PSI ÷ 14.50
Liter = Gal. ÷ 3.79

Series # 527

Material group	Hardness	SFM	Feed Rate - IPR											
			1/16 in. 1.590 mm	1/8 in. 3.170 mm	1/4 in. 6.350 mm	3/8 in. 9.520 mm	1/2 in. 12.700 mm	5/8 in. 15.870 mm	3/4 in. 19.050 mm	1 in. 25.400 mm	1 1/4 in. 31.750 mm	1 1/2 in. 38.100 mm		
Common structural steels	≤100 Bhn >100-260 Bhn	70 55	•	•	•	•	•	•	•	•	•	•	•	•
Free-cutting steels	≤24 Rc >24-30 Rc	70 55	•	•	•	0.0080	0.0100	0.0100	0.0100	0.0100	0.0125	•	•	•
Unalloyed heat-treatable steels	≤16 Rc 16-24 Rc 24-30 Rc	70 55 •	•	•	•	0.0065	0.0080	0.0080	0.0080	0.0090	0.0100	•	•	•
Alloyed heat-treatable steels	24-30 Rc >30-38 Rc	35 •	•	•	•	0.0050	0.0065	0.0065	0.0070	0.0080	•	•	•	•
Unalloyed case hardened steels	≤230 Bhn	70	•	•	•	0.0080	0.0100	0.0100	0.0110	0.0125	•	•	•	•
Alloyed case hardened steels	24-30 Rc >30-38 Rc	30 •	•	•	•	0.0050	0.0065	0.0065	0.0070	0.0080	•	•	•	•
Nitriding steels	≥24-30 Rc >30-38 Rc	25 •	•	•	•	0.0050	0.0065	0.0065	0.0070	0.0080	•	•	•	•
Tool steels	≤24 Rc >24-30 Rc	35 15	•	•	•	0.0050	0.0065	0.0065	0.0070	0.0080	•	•	•	•
High speed steels	≥14-30 Rc	15	•	•	•	0.0040	0.0050	0.0050	0.0055	0.0065	•	•	•	•
Spring steels	≤330 Bhn	•	•	•	•	•	•	•	•	•	•	•	•	•
Stainless steels, sulphured austenitic martensitic	≤24 Rc • • • •	25 • • • •	•	•	•	0.0050	0.0065	0.0065	0.0070	0.0080	•	•	•	•
Hardened steels	≤40-48 Rc >48-60 Rc	• •	•	•	•	•	•	•	•	•	•	•	•	•
Special alloys	≤38 Rc	•	•	•	•	•	•	•	•	•	•	•	•	•
Cast iron	≤240 Bhn <300 Bhn	70 55	•	•	•	0.0080	0.0100	0.0100	0.0110	0.0125	•	•	•	•
Spheroidal graphite iron and malleable cast iron	≤240 Bhn <300 Bhn	65 45	•	•	•	0.0080	0.0100	0.0100	0.0110	0.0125	•	•	•	•
Chilled cast iron	≤350 Bhn	•	•	•	•	•	•	•	•	•	•	•	•	•
Ti and Ti-alloys	≤24 Rc >24-38 Rc	• •	•	•	•	•	•	•	•	•	•	•	•	•
Aluminium and Al-alloys	≤120 Bhn	•	•	•	•	•	•	•	•	•	•	•	•	•
Al wrought alloys	≤150 Bhn	•	•	•	•	•	•	•	•	•	•	•	•	•
Al cast alloys ≤ 10 % Si > 10 % Si	≤200 Bhn 115	145 115	•	•	•	0.0100	0.0125	0.0125	0.0140	0.0160	•	•	•	•
Magnesium alloys	≤150 Bhn	180	•	•	•	0.0080	0.0100	0.0100	0.0110	0.0125	•	•	•	•
Copper, low-alloyed	≤120 Bhn	70	•	•	•	0.0065	0.0080	0.0080	0.0090	0.0100	•	•	•	•
Brass, short-chipping long-chipping	≤200 Bhn • • •	• • • •	•	•	•	•	•	•	•	•	•	•	•	•
Bronze, short-chipping	≤200 Bhn >200-260 Bhn	70 65	•	•	•	0.0050	0.0065	0.0065	0.0070	0.0080	•	•	•	•
Bronze, long-chipping	≤24 Rc >24-30 Rc	55 •	•	•	•	0.0050	0.0065	0.0065	0.0070	0.0080	•	•	•	•
Duroplastics	-	35	•	•	•	0.0050	0.0065	0.0065	0.0070	0.0080	•	•	•	•
Thermoplastics	-	55	•	•	•	0.0065	0.0080	0.0080	0.0090	0.0100	•	•	•	•
Reinforced plastics - Kevlar	-	•	•	•	•	•	•	•	•	•	•	•	•	•
Reinforced plastics - GFK / CFK	-	•	•	•	•	•	•	•	•	•	•	•	•	•

Series # 530

Material group	Hardness	SFM	Feed Rate - IPR											
			1/16 in. 1.590 mm	1/8 in. 3.170 mm	1/4 in. 6.350 mm	3/8 in. 9.520 mm	1/2 in. 12.700 mm	5/8 in. 15.870 mm	3/4 in. 19.050 mm	1 in. 25.400 mm	1 1/4 in. 31.750 mm	1 1/2 in. 38.100 mm		
Common structural steels	≤100 Bhn >100-260 Bhn	160 130	0.0017	0.0050	0.0080	0.0100	0.0125	0.0125	•	•	•	•	•	•
Free-cutting steels	≤24 Rc >24-30 Rc	195 160	0.0017	0.0050	0.0080	0.0100	0.0125	0.0125	•	•	•	•	•	•
Unalloyed heat-treatable steels	≤16 Rc 16-24 Rc 24-30 Rc	130 130 100	0.0017	0.0050	0.0080	0.0100	0.0125	0.0125	•	•	•	•	•	•
Alloyed heat-treatable steels	24-30 Rc >30-38 Rc	100 100	0.0012	0.0030	0.0050	0.0065	0.0080	0.0080	•	•	•	•	•	•
Unalloyed case hardened steels	≤230 Bhn	130	0.0010	0.0025	0.0040	0.0050	0.0065	0.0065	•	•	•	•	•	•
Alloyed case hardened steels	24-30 Rc >30-38 Rc	80 65	0.0012	0.0030	0.0050	0.0065	0.0080	0.0080	•	•	•	•	•	•
Nitriding steels	≥24-30 Rc >30-38 Rc	65 65	0.0012	0.0030	0.0050	0.0065	0.0080	0.0080	•	•	•	•	•	•
Tool steels	≤24 Rc >24-30 Rc	80 65	0.0012	0.0030	0.0050	0.0065	0.0080	0.0080	•	•	•	•	•	•
High speed steels	≥14-30 Rc	65	0.0010	0.0025	0.0040	0.0050	0.0065	0.0065	•	•	•	•	•	•
Spring steels	≤330 Bhn	35	0.0007	0.0020	0.0030	0.0040	0.0050	0.0050	•	•	•	•	•	•
Stainless steels, sulphured austenitic martensitic	≤24 Rc • • •	65 45 • 65	0.0012	0.0030	0.0050	0.0065	0.0080	0.0080	•	•	•	•	•	•
Hardened steels	≤40-48 Rc >48-60 Rc	• •	•	•	•	•	•	•	•	•	•	•	•	•
Special alloys	≤38 Rc	40	0.0007	0.0020	0.0030	0.0040	0.0050	0.0050	•	•	•	•	•	•
Cast iron	≤240 Bhn <300 Bhn	145 115	0.0017	0.0050	0.0080	0.0100	0.0125	0.0125	•	•	•	•	•	•
Spheroidal graphite iron and malleable cast iron	≤240 Bhn <300 Bhn	130 100	0.0017	0.0050	0.0080	0.0100	0.0125	0.0125	•	•	•	•	•	•
Chilled cast iron	≤350 Bhn	•	•	•	•	•	•	•	•	•	•	•	•	•
Ti and Ti-alloys	≤24 Rc >24-38 Rc	• •	•	•	•	•	•	•	•	•	•	•	•	•
Aluminium and Al-alloys	≤120 Bhn	•	•	•	•	•	•	•	•	•	•	•	•	•
Al wrought alloys	≤150 Bhn	•	•	•	•	•	•	•	•	•	•	•	•	•
Al cast alloys ≤ 10 % Si > 10 % Si	≤200 Bhn 260	295 260	0.0020	0.0065	0.0100	0.0125	0.0160	0.0160	•	•	•	•	•	•
Magnesium alloys	≤150 Bhn	260	0.0017	0.0050	0.0080	0.0100	0.0125	0.0125	•	•	•	•	•	•
Copper, low-alloyed	≤120 Bhn	•	•	•	•	•	•	•	•	•	•	•	•	•
Brass, short-chipping long-chipping	≤200 Bhn • • •	• • • •	•	•	•	•	•	•	•	•	•	•	•	•
Bronze, short-chipping	≤200 Bhn >200-260 Bhn	• •	•	•	•	•	•	•	•	•	•	•	•	•
Bronze, long-chipping	≤24 Rc >24-30 Rc	• •	•	•	•	•	•	•	•	•	•	•	•	•
Duroplastics	-	•	•	•	•	•	•	•	•	•	•	•	•	•
Thermoplastics	-	•	•	•	•	•	•	•	•	•	•	•	•	•
Reinforced plastics - Kevlar	-	•	•	•	•	•	•	•	•	•	•	•	•	•
Reinforced plastics - GFK / CFK	-	•	•	•	•	•	•	•	•	•	•	•	•	•

Using These Tables. The Speeds & Feeds listed below are conservative recommendations for initial setup. In actual use, depending on the machining environment and workpiece material, significantly higher speeds and feeds may be achievable. Using the below as a starting point, cutting speed/feed can be gradually adjusted upwards until the optimum settings per application are found.
 Questions? Contact us by telephone at (800) 776-6170.

Series # 535

Material group	Hardness	SFM	Feed Rate - IPR									
			1/16 in. 1.590 mm	1/8 in. 3.170 mm	1/4 in. 6.350 mm	3/8 in. 9.520 mm	1/2 in. 12.700 mm	5/8 in. 15.870 mm	3/4 in. 19.050 mm	1 in. 25.400 mm	1 1/4 in. 31.750 mm	1 1/2 in. 38.100 mm
Common structural steels	≤100 Bhn >100-260 Bhn	90 70	0.0017 0.0015	0.0050 0.0040	0.0080 0.0065	0.0100 0.0080	0.0125 0.0100	0.0125 0.0100	•	•	•	•
Free-cutting steels	≤24 Rc >24-30 Rc	90 70	0.0017 0.0015	0.0050 0.0040	0.0080 0.0065	0.0100 0.0080	0.0125 0.0100	0.0125 0.0100	•	•	•	•
Unalloyed heat-treatable steels	≤16 Rc 16-24 Rc 24-30 Rc	90 90 •	0.0015 0.0015 •	0.0040 0.0040 •	0.0065 0.0065 •	0.0080 0.0080 •	0.0100 0.0100 •	0.0100 0.0100 •	•	•	•	•
Alloyed heat-treatable steels	24-30 Rc >30-38 Rc	• •	• •	• •	• •	• •	• •	• •	•	•	•	•
Unalloyed case hardened steels	≤230 Bhn	90	0.0017	0.0050	0.0080	0.0100	0.0125	0.0125	•	•	•	•
Alloyed case hardened steels	24-30 Rc >30-38 Rc	• •	• •	• •	• •	• •	• •	• •	•	•	•	•
Nitriding steels	≥24-30 Rc >30-38 Rc	• •	• •	• •	• •	• •	• •	• •	•	•	•	•
Tool steels	≤24 Rc >24-30 Rc	45 •	0.0012 •	0.0030 •	0.0050 •	0.0065 •	0.0080 •	0.0080 •	•	•	•	•
High speed steels	≥14-30 Rc	•	•	•	•	•	•	•	•	•	•	•
Spring steels	≤330 Bhn	•	•	•	•	•	•	•	•	•	•	•
Stainless steels, sulphured austenitic martensitic	≤24 Rc • • •	• • • •	• • • •	• • • •	• • • •	• • • •	• • • •	• • • •	• • • •	•	•	•
Hardened steels	≤40-48 Rc >48-60 Rc	• •	• •	• •	• •	• •	• •	• •	•	•	•	•
Special alloys	≤38 Rc	•	•	•	•	•	•	•	•	•	•	•
Cast iron	≤240 Bhn <300 Bhn	90 70	0.0017 0.0017	0.0050 0.0050	0.0080 0.0080	0.0100 0.0100	0.0125 0.0125	0.0125 0.0125	•	•	•	•
Spheroidal graphite iron and malleable cast iron	≤240 Bhn <300 Bhn	70 55	0.0017 0.0017	0.0050 0.0050	0.0080 0.0080	0.0100 0.0100	0.0125 0.0125	0.0125 0.0125	•	•	•	•
Chilled cast iron	≤350 Bhn	•	•	•	•	•	•	•	•	•	•	•
Ti and Ti-alloys	≤24 Rc >24-38 Rc	• •	• •	• •	• •	• •	• •	• •	•	•	•	•
Aluminium and Al-alloys	≤120 Bhn	•	•	•	•	•	•	•	•	•	•	•
Al wrought alloys	≤150 Bhn	•	•	•	•	•	•	•	•	•	•	•
Al cast alloys ≤ 10 % Si > 10 % Si	≤200 Bhn ≤200 Bhn	180 145	0.0020 0.0017	0.0065 0.0050	0.0100 0.0080	0.0125 0.0100	0.0160 0.0125	0.0160 0.0125	•	•	•	•
Magnesium alloys	≤150 Bhn	•	•	•	•	•	•	•	•	•	•	•
Copper, low-alloyed	≤120 Bhn	90	0.0015	0.0040	0.0065	0.0080	0.0100	0.0100	•	•	•	•
Brass, short-chipping long-chipping	≤200 Bhn ≤200 Bhn	• 110	• 0.0015	• 0.0040	• 0.0065	• 0.0080	• 0.0100	• 0.0100	•	•	•	•
Bronze, short-chipping	≤200 Bhn >200-260 Bhn	• •	• •	• •	• •	• •	• •	• •	•	•	•	•
Bronze, long-chipping	≤24 Rc >24-30 Rc	70 •	0.0012 •	0.0030 •	0.0050 •	0.0065 •	0.0080 •	0.0080 •	•	•	•	•
Duroplastics Thermoplastics	- -	45 •	0.0012 •	0.0030 •	0.0050 •	0.0065 •	0.0080 •	0.0080 •	•	•	•	•
Reinforced plastics - Kevlar Reinforced plastics - GFK / CFK	- -	• •	• •	• •	• •	• •	• •	• •	•	•	•	•

Series # 549

Material group	Hardness	SFM	Feed Rate - IPR									
			1/16 in. 1.590 mm	1/8 in. 3.170 mm	1/4 in. 6.350 mm	3/8 in. 9.520 mm	1/2 in. 12.700 mm	5/8 in. 15.870 mm	3/4 in. 19.050 mm	1 in. 25.400 mm	1 1/4 in. 31.750 mm	1 1/2 in. 38.100 mm
Common structural steels	≤100 Bhn >100-260 Bhn	100 80	0.0017 0.0015	0.0050 0.0040	0.0080 0.0065	0.0100 0.0080	0.0125 0.0100	0.0125 0.0100	•	•	•	•
Free-cutting steels	≤24 Rc >24-30 Rc	100 80	0.0017 0.0015	0.0050 0.0040	0.0080 0.0065	0.0100 0.0080	0.0125 0.0100	0.0125 0.0100	•	•	•	•
Unalloyed heat-treatable steels	≤16 Rc 16-24 Rc 24-30 Rc	100 80 •	0.0015 0.0015 •	0.0040 0.0040 •	0.0065 0.0065 •	0.0080 0.0080 •	0.0100 0.0100 •	0.0100 0.0100 •	•	•	•	•
Alloyed heat-treatable steels	24-30 Rc >30-38 Rc	• •	• •	• •	• •	• •	• •	• •	•	•	•	•
Unalloyed case hardened steels	≤230 Bhn	100	0.0017	0.0050	0.0080	0.0100	0.0125	0.0125	•	•	•	•
Alloyed case hardened steels	24-30 Rc >30-38 Rc	• •	• •	• •	• •	• •	• •	• •	•	•	•	•
Nitriding steels	≥24-30 Rc >30-38 Rc	• •	• •	• •	• •	• •	• •	• •	•	•	•	•
Tool steels	≤24 Rc >24-30 Rc	50 •	0.0012 •	0.0030 •	0.0050 •	0.0065 •	0.0080 •	0.0080 •	•	•	•	•
High speed steels	≥14-30 Rc	•	•	•	•	•	•	•	•	•	•	•
Spring steels	≤330 Bhn	•	•	•	•	•	•	•	•	•	•	•
Stainless steels, sulphured austenitic martensitic	≤24 Rc • • •	• • • •	• • • •	• • • •	• • • •	• • • •	• • • •	• • • •	• • • •	•	•	•
Hardened steels	≤40-48 Rc >48-60 Rc	• •	• •	• •	• •	• •	• •	• •	•	•	•	•
Special alloys	≤38 Rc	•	•	•	•	•	•	•	•	•	•	•
Cast iron	≤240 Bhn <300 Bhn	100 80	0.0017 0.0017	0.0050 0.0050	0.0080 0.0080	0.0100 0.0100	0.0125 0.0125	0.0125 0.0125	•	•	•	•
Spheroidal graphite iron and malleable cast iron	≤240 Bhn <300 Bhn	90 65	0.0017 0.0017	0.0050 0.0050	0.0080 0.0080	0.0100 0.0100	0.0125 0.0125	0.0125 0.0125	•	•	•	•
Chilled cast iron	≤350 Bhn	•	•	•	•	•	•	•	•	•	•	•
Ti and Ti-alloys	≤24 Rc >24-38 Rc	• •	• •	• •	• •	• •	• •	• •	•	•	•	•
Aluminium and Al-alloys	≤120 Bhn	260	0.0020	0.0065	0.0100	0.0125	0.0160	0.0160	•	•	•	•
Al wrought alloys	≤150 Bhn	260	0.0020	0.0065	0.0100	0.0125	0.0160	0.0160	•	•	•	•
Al cast alloys ≤ 10 % Si > 10 % Si	≤200 Bhn ≤200 Bhn	205 130	0.0020 0.0017	0.0065 0.0050	0.0100 0.0080	0.0125 0.0100	0.0160 0.0125	0.0160 0.0125	•	•	•	•
Magnesium alloys	≤150 Bhn	260	0.0017	0.0050	0.0080	0.0100	0.0125	0.0125	•	•	•	•
Copper, low-alloyed	≤120 Bhn	100	0.0015	0.0040	0.0065	0.0080	0.0100	0.0100	•	•	•	•
Brass, short-chipping long-chipping	≤200 Bhn ≤200 Bhn	• 130	• 0.0015	• 0.0040	• 0.0065	• 0.0080	• 0.0100	• 0.0100	•	•	•	•
Bronze, short-chipping	≤200 Bhn >200-260 Bhn	• •	• •	• •	• •	• •	• •	• •	•	•	•	•
Bronze, long-chipping	≤24 Rc >24-30 Rc	80 •	0.0012 •	0.0030 •	0.0050 •	0.0065 •	0.0080 •	0.0080 •	•	•	•	•
Duroplastics Thermoplastics	- -	50 •	0.0012 •	0.0030 •	0.0050 •	0.0065 •	0.0080 •	0.0080 •	•	•	•	•
Reinforced plastics - Kevlar Reinforced plastics - GFK / CFK	- -	• •	• •	• •	• •	• •	• •	• •	•	•	•	•

Using These Tables. The Speeds & Feeds listed below are conservative recommendations for initial setup. In actual use, depending on the machining environment and workpiece material, significantly higher speeds and feeds may be achievable. Using the below as a starting point, cutting speed/feed can be gradually adjusted upwards until the optimum settings per application are found.
 Questions? Contact us by telephone at (800) 776-6170.

Series # 552

Material group	Hardness	SFM	Feed Rate - IPR										
			1/16 in. 1.590 mm	1/8 in. 3.170 mm	1/4 in. 6.350 mm	3/8 in. 9.520 mm	1/2 in. 12.700 mm	5/8 in. 15.870 mm	3/4 in. 19.050 mm	1 in. 25.400 mm	1 1/4 in. 31.750 mm	1 1/2 in. 38.100 mm	
Common structural steels	≤100 Bhn >100-260 Bhn	115 90	0.0017 0.0015	0.0050 0.0040	0.0080 0.0065	0.0100 0.0080	0.0125 0.0100	0.0125 0.0100	0.0140 0.0110	•	•	•	
Free-cutting steels	≤24 Rc >24-30 Rc	115 90	0.0017 0.0015	0.0050 0.0040	0.0080 0.0065	0.0100 0.0080	0.0125 0.0100	0.0125 0.0100	0.0140 0.0110	•	•	•	
Unalloyed heat-treatable steels	≤16 Rc 16-24 Rc 24-30 Rc	115 90 •	0.0015 0.0015 •	0.0040 0.0040 •	0.0065 0.0065 •	0.0080 0.0080 •	0.0100 0.0100 •	0.0100 0.0100 •	0.0110 0.0110 •	•	•	•	
Alloyed heat-treatable steels	24-30 Rc >30-38 Rc	• •	• •	• •	• •	• •	• •	• •	• •	•	•	•	
Unalloyed case hardened steels	≤230 Bhn	115	0.0017	0.0050	0.0080	0.0100	0.0125	0.0125	0.0140	•	•	•	
Alloyed case hardened steels	24-30 Rc >30-38 Rc	• •	• •	• •	• •	• •	• •	• •	• •	•	•	•	
Nitriding steels	≥24-30 Rc >30-38 Rc	• •	• •	• •	• •	• •	• •	• •	• •	•	•	•	
Tool steels	≤24 Rc >24-30 Rc	55 •	0.0012 •	0.0030 •	0.0050 •	0.0065 •	0.0080 •	0.0080 •	0.0090 •	•	•	•	
High speed steels	≥14-30 Rc	•	•	•	•	•	•	•	•	•	•	•	
Spring steels	≤330 Bhn	•	•	•	•	•	•	•	•	•	•	•	
Stainless steels, sulphured austenitic martensitic	≤24 Rc • • •	• • • •	• • • •	• • • •	• • • •	• • • •	• • • •	• • • •	• • • •	• • • •	•	•	•
Hardened steels	≤40-48 Rc >48-60 Rc	• •	• •	• •	• •	• •	• •	• •	• •	•	•	•	
Special alloys	≤38 Rc	•	•	•	•	•	•	•	•	•	•	•	
Cast iron	≤240 Bhn <300 Bhn	115 90	0.0017 0.0017	0.0050 0.0050	0.0080 0.0080	0.0100 0.0100	0.0125 0.0125	0.0125 0.0125	0.0140 0.0140	•	•	•	
Spheroidal graphite iron and malleable cast iron	≤240 Bhn <300 Bhn	100 75	0.0017 0.0017	0.0050 0.0050	0.0080 0.0080	0.0100 0.0100	0.0125 0.0125	0.0125 0.0125	0.0140 0.0140	•	•	•	
Chilled cast iron	≤350 Bhn	•	•	•	•	•	•	•	•	•	•	•	
Ti and Ti-alloys	≤24 Rc >24-38 Rc	• •	• •	• •	• •	• •	• •	• •	• •	•	•	•	
Aluminium and Al-alloys	≤120 Bhn	295	0.0020	0.0065	0.0100	0.0125	0.0160	0.0160	0.0180	•	•	•	
Al wrought alloys	≤150 Bhn	295	0.0020	0.0065	0.0100	0.0125	0.0160	0.0160	0.0180	•	•	•	
Al cast alloys ≤ 10 % Si > 10 % Si	≤200 Bhn • •	225 180 •	0.0020 0.0017 •	0.0065 0.0050 •	0.0100 0.0080 •	0.0125 0.0100 •	0.0160 0.0125 •	0.0160 0.0125 •	0.0180 0.0140 •	•	•	•	
Magnesium alloys	≤150 Bhn	295	0.0017	0.0050	0.0080	0.0100	0.0125	0.0125	0.0140	•	•	•	
Copper, low-alloyed	≤120 Bhn	115	0.0015	0.0040	0.0065	0.0080	0.0100	0.0100	0.0110	•	•	•	
Brass, short-chipping long-chipping	≤200 Bhn • •	• 145 •	• 0.0015 •	• 0.0040 •	• 0.0065 •	• 0.0080 •	• 0.0100 •	• 0.0100 •	• 0.0110 •	•	•	•	
Bronze, short-chipping	≤200 Bhn >200-260 Bhn	115 100	0.0012 0.0012	0.0030 0.0030	0.0050 0.0050	0.0065 0.0065	0.0080 0.0080	0.0080 0.0080	0.0090 0.0090	•	•	•	
Bronze, long-chipping	≤24 Rc >24-30 Rc	90 •	0.0012 •	0.0030 •	0.0050 •	0.0065 •	0.0080 •	0.0080 •	0.0090 •	•	•	•	
Duroplastics	-	55	0.0012	0.0030	0.0050	0.0065	0.0080	0.0080	0.0090	•	•	•	
Thermoplastics	-	90	0.0015	0.0040	0.0065	0.0080	0.0100	0.0100	0.0110	•	•	•	
Reinforced plastics - Kevlar	-	•	•	•	•	•	•	•	•	•	•	•	
Reinforced plastics - GFK / CFK	-	•	•	•	•	•	•	•	•	•	•	•	

Series # 553

Material group	Hardness	SFM	Feed Rate - IPR										
			1/16 in. 1.590 mm	1/8 in. 3.170 mm	1/4 in. 6.350 mm	3/8 in. 9.520 mm	1/2 in. 12.700 mm	5/8 in. 15.870 mm	3/4 in. 19.050 mm	1 in. 25.400 mm	1 1/4 in. 31.750 mm	1 1/2 in. 38.100 mm	
Common structural steels	≤100 Bhn >100-260 Bhn	115 90	0.0017 0.0015	0.0050 0.0040	0.0080 0.0065	0.0100 0.0080	0.0125 0.0100	•	•	•	•	•	
Free-cutting steels	≤24 Rc >24-30 Rc	115 90	0.0017 0.0015	0.0050 0.0040	0.0080 0.0065	0.0100 0.0080	0.0125 0.0100	•	•	•	•	•	
Unalloyed heat-treatable steels	≤16 Rc 16-24 Rc 24-30 Rc	115 90 •	0.0015 0.0015 •	0.0040 0.0040 •	0.0065 0.0065 •	0.0080 0.0080 •	0.0100 0.0100 •	•	•	•	•	•	
Alloyed heat-treatable steels	24-30 Rc >30-38 Rc	• •	• •	• •	• •	• •	• •	• •	• •	•	•	•	
Unalloyed case hardened steels	≤230 Bhn	115	0.0017	0.0050	0.0080	0.0100	0.0125	•	•	•	•	•	
Alloyed case hardened steels	24-30 Rc >30-38 Rc	• •	• •	• •	• •	• •	• •	• •	• •	•	•	•	
Nitriding steels	≥24-30 Rc >30-38 Rc	• •	• •	• •	• •	• •	• •	• •	• •	•	•	•	
Tool steels	≤24 Rc >24-30 Rc	55 •	0.0012 •	0.0030 •	0.0050 •	0.0065 •	0.0080 •	•	•	•	•	•	
High speed steels	≥14-30 Rc	•	•	•	•	•	•	•	•	•	•	•	
Spring steels	≤330 Bhn	•	•	•	•	•	•	•	•	•	•	•	
Stainless steels, sulphured austenitic martensitic	≤24 Rc • • •	• • • •	• • • •	• • • •	• • • •	• • • •	• • • •	• • • •	• • • •	• • • •	•	•	•
Hardened steels	≤40-48 Rc >48-60 Rc	• •	• •	• •	• •	• •	• •	• •	• •	•	•	•	
Special alloys	≤38 Rc	•	•	•	•	•	•	•	•	•	•	•	
Cast iron	≤240 Bhn <300 Bhn	115 90	0.0017 0.0017	0.0050 0.0050	0.0080 0.0080	0.0100 0.0100	0.0125 0.0125	•	•	•	•	•	
Spheroidal graphite iron and malleable cast iron	≤240 Bhn <300 Bhn	100 75	0.0017 0.0017	0.0050 0.0050	0.0080 0.0080	0.0100 0.0100	0.0125 0.0125	•	•	•	•	•	
Chilled cast iron	≤350 Bhn	•	•	•	•	•	•	•	•	•	•	•	
Ti and Ti-alloys	≤24 Rc >24-38 Rc	• •	• •	• •	• •	• •	• •	• •	• •	•	•	•	
Aluminium and Al-alloys	≤120 Bhn	295	0.0020	0.0065	0.0100	0.0125	0.0160	•	•	•	•	•	
Al wrought alloys	≤150 Bhn	295	0.0020	0.0065	0.0100	0.0125	0.0160	•	•	•	•	•	
Al cast alloys ≤ 10 % Si > 10 % Si	≤200 Bhn • •	225 180 •	0.0020 0.0017 •	0.0065 0.0050 •	0.0100 0.0080 •	0.0125 0.0100 •	0.0160 0.0125 •	•	•	•	•	•	
Magnesium alloys	≤150 Bhn	295	0.0017	0.0050	0.0080	0.0100	0.0125	•	•	•	•	•	
Copper, low-alloyed	≤120 Bhn	115	0.0015	0.0040	0.0065	0.0080	0.0100	•	•	•	•	•	
Brass, short-chipping long-chipping	≤200 Bhn • •	• 145 •	• 0.0015 •	• 0.0040 •	• 0.0065 •	• 0.0080 •	• 0.0100 •	• • •	• • •	•	•	•	
Bronze, short-chipping	≤200 Bhn >200-260 Bhn	115 100	0.0012 0.0012	0.0030 0.0030	0.0050 0.0050	0.0065 0.0065	0.0080 0.0080	•	•	•	•	•	
Bronze, long-chipping	≤24 Rc >24-30 Rc	90 •	0.0012 •	0.0030 •	0.0050 •	0.0065 •	0.0080 •	•	•	•	•	•	
Duroplastics	-	55	0.0012	0.0030	0.0050	0.0065	0.0080	•	•	•	•	•	
Thermoplastics	-	90	0.0015	0.0040	0.0065	0.0080	0.0100	•	•	•	•	•	
Reinforced plastics - Kevlar	-	•	•	•	•	•	•	•	•	•	•	•	
Reinforced plastics - GFK / CFK	-	•	•	•	•	•	•	•	•	•	•	•	

Using These Tables. The Speeds & Feeds listed below are conservative recommendations for initial setup. In actual use, depending on the machining environment and workpiece material, significantly higher speeds and feeds may be achievable. Using the below as a starting point, cutting speed/feed can be gradually adjusted upwards until the optimum settings per application are found.
 Questions? Contact us by telephone at (800) 776-6170.

Series # 610

Material group	Hardness	SFM	Feed Rate - IPR									
			1/16 in. 1.590 mm	1/8 in. 3.170 mm	1/4 in. 6.350 mm	3/8 in. 9.520 mm	1/2 in. 12.700 mm	5/8 in. 15.870 mm	3/4 in. 19.050 mm	1 in. 25.400 mm	1 1/4 in. 31.750 mm	1 1/2 in. 38.100 mm
Common structural steels	≤100 Bhn >100-260 Bhn	130 100	0.0017 0.0015	0.0050 0.0040	0.0080 0.0065	0.0100 0.0080	0.0125 0.0100	0.0125 0.0100	•	•	•	•
Free-cutting steels	≤24 Rc >24-30 Rc	155 125	0.0017 0.0017	0.0050 0.0050	0.0080 0.0080	0.0100 0.0100	0.0125 0.0125	0.0125 0.0125	•	•	•	•
Unalloyed heat-treatable steels	≤16 Rc 16-24 Rc 24-30 Rc	130 100 65	0.0017 0.0017 0.0015	0.0050 0.0050 0.0040	0.0080 0.0080 0.0065	0.0100 0.0100 0.0080	0.0125 0.0125 0.0100	0.0125 0.0125 0.0100	•	•	•	•
Alloyed heat-treatable steels	24-30 Rc >30-38 Rc	55 35	0.0012 0.0010	0.0030 0.0025	0.0050 0.0040	0.0065 0.0050	0.0080 0.0065	0.0080 0.0065	•	•	•	•
Unalloyed case hardened steels	≤230 Bhn	100	0.0017	0.0050	0.0080	0.0100	0.0125	0.0125	•	•	•	•
Alloyed case hardened steels	24-30 Rc >30-38 Rc	50 35	0.0012 0.0010	0.0030 0.0025	0.0050 0.0040	0.0065 0.0050	0.0080 0.0065	0.0080 0.0065	•	•	•	•
Nitriding steels	≥24-30 Rc >30-38 Rc	45 35	0.0012 0.0010	0.0030 0.0025	0.0050 0.0040	0.0065 0.0050	0.0080 0.0065	0.0080 0.0065	•	•	•	•
Tool steels	≤24 Rc >24-30 Rc	55 30	0.0012 0.0010	0.0030 0.0025	0.0050 0.0040	0.0065 0.0050	0.0080 0.0065	0.0080 0.0065	•	•	•	•
High speed steels	≥14-30 Rc	30	0.0010	0.0025	0.0040	0.0050	0.0065	0.0065	•	•	•	•
Spring steels	≤330 Bhn	•	•	•	•	•	•	•	•	•	•	•
Stainless steels, sulphured	≤24 Rc	50	0.0012	0.0030	0.0050	0.0065	0.0080	0.0080	•	•	•	•
austenitic	≤24 Rc	35	0.0012	0.0030	0.0050	0.0065	0.0080	0.0080	•	•	•	•
martensitic	≤24 Rc	45	0.0012	0.0030	0.0050	0.0065	0.0080	0.0080	•	•	•	•
Hardened steels	≤40-48 Rc >48-60 Rc	•	•	•	•	•	•	•	•	•	•	•
Special alloys	≤38 Rc	•	•	•	•	•	•	•	•	•	•	•
Cast iron	≤240 Bhn <300 Bhn	115 90	0.0017 0.0017	0.0050 0.0050	0.0080 0.0080	0.0100 0.0100	0.0125 0.0125	0.0125 0.0125	•	•	•	•
Spheroidal graphite iron and malleable cast iron	≤240 Bhn <300 Bhn	100 80	0.0017 0.0017	0.0050 0.0050	0.0080 0.0080	0.0100 0.0100	0.0125 0.0125	0.0125 0.0125	•	•	•	•
Chilled cast iron	≤350 Bhn	•	•	•	•	•	•	•	•	•	•	•
Ti and Ti-alloys	≤24 Rc >24-38 Rc	•	•	•	•	•	•	•	•	•	•	•
Aluminium and Al-alloys	≤120 Bhn	180	0.0020	0.0065	0.0100	0.0125	0.0160	0.0160	•	•	•	•
Al wrought alloys	≤150 Bhn	180	0.0020	0.0065	0.0100	0.0125	0.0160	0.0160	•	•	•	•
Al cast alloys ≤ 10 % Si	≤200 Bhn	230	0.0020	0.0065	0.0100	0.0125	0.0160	0.0160	•	•	•	•
> 10 % Si	≤200 Bhn	185	0.0017	0.0050	0.0080	0.0100	0.0125	0.0125	•	•	•	•
Magnesium alloys	≤150 Bhn	205	0.0017	0.0050	0.0080	0.0100	0.0125	0.0125	•	•	•	•
Copper, low-alloyed	≤120 Bhn	80	0.0015	0.0040	0.0065	0.0080	0.0100	0.0100	•	•	•	•
Brass, short-chipping	≤200 Bhn	165	0.0015	0.0040	0.0065	0.0080	0.0100	0.0100	•	•	•	•
long-chipping	≤200 Bhn	100	0.0015	0.0040	0.0065	0.0080	0.0100	0.0100	•	•	•	•
Bronze, short-chipping	≤200 Bhn >200-260 Bhn	130 75	0.0012 0.0012	0.0030 0.0030	0.0050 0.0050	0.0065 0.0065	0.0080 0.0080	0.0080 0.0080	•	•	•	•
Bronze, long-chipping	≤24 Rc >24-30 Rc	100 75	0.0012 0.0012	0.0030 0.0030	0.0050 0.0050	0.0065 0.0065	0.0080 0.0080	0.0080 0.0080	•	•	•	•
Duroplastics	–	65	0.0012	0.0030	0.0050	0.0065	0.0080	0.0080	•	•	•	•
Thermoplastics	–	65	0.0012	0.0030	0.0050	0.0065	0.0080	0.0080	•	•	•	•
Reinforced plastics - Kevlar	–	•	•	•	•	•	•	•	•	•	•	•
Reinforced plastics - GFK / CFK	–	•	•	•	•	•	•	•	•	•	•	•

Series # 617

Material group	Hardness	SFM	Feed Rate - IPR									
			1/16 in. 1.590 mm	1/8 in. 3.170 mm	1/4 in. 6.350 mm	3/8 in. 9.520 mm	1/2 in. 12.700 mm	5/8 in. 15.870 mm	3/4 in. 19.050 mm	1 in. 25.400 mm	1 1/4 in. 31.750 mm	1 1/2 in. 38.100 mm
Common structural steels	≤100 Bhn >100-260 Bhn	•	•	•	•	•	•	•	•	•	•	•
Free-cutting steels	≤24 Rc >24-30 Rc	•	•	•	•	•	•	•	•	•	•	•
Unalloyed heat-treatable steels	≤16 Rc 16-24 Rc 24-30 Rc	•	•	•	•	•	•	•	•	•	•	•
Alloyed heat-treatable steels	24-30 Rc >30-38 Rc	•	0.0010	0.0025	0.0040	0.0050	0.0065	•	•	•	•	•
Unalloyed case hardened steels	≤230 Bhn	•	•	•	•	•	•	•	•	•	•	•
Alloyed case hardened steels	24-30 Rc >30-38 Rc	•	•	•	•	•	•	•	•	•	•	•
Nitriding steels	≥24-30 Rc >30-38 Rc	•	•	•	•	•	•	•	•	•	•	•
Tool steels	≤24 Rc >24-30 Rc	•	•	•	•	•	•	•	•	•	•	•
High speed steels	≥14-30 Rc	•	•	•	•	•	•	•	•	•	•	•
Spring steels	≤330 Bhn	•	•	•	•	•	•	•	•	•	•	•
Stainless steels, sulphured	≤24 Rc	35	0.0012	0.0030	0.0050	0.0065	0.0080	•	•	•	•	•
austenitic	≤24 Rc	25	0.0010	0.0025	0.0040	0.0050	0.0065	•	•	•	•	•
martensitic	≤24 Rc	30	0.0010	0.0025	0.0040	0.0050	0.0065	•	•	•	•	•
Hardened steels	≤40-48 Rc >48-60 Rc	•	•	•	•	•	•	•	•	•	•	•
Special alloys	≤38 Rc	15	0.0005	0.0015	0.0025	0.0030	0.0040	•	•	•	•	•
Cast iron	≤240 Bhn <300 Bhn	•	•	•	•	•	•	•	•	•	•	•
Spheroidal graphite iron and malleable cast iron	≤240 Bhn <300 Bhn	•	•	•	•	•	•	•	•	•	•	•
Chilled cast iron	≤350 Bhn	15	0.0010	0.0025	0.0040	0.0050	0.0065	•	•	•	•	•
Ti and Ti-alloys	≤24 Rc >24-38 Rc	25 15	0.0007 0.0007	0.0020 0.0020	0.0030 0.0030	0.0040 0.0040	0.0050 0.0050	•	•	•	•	•
Aluminium and Al-alloys	≤120 Bhn	•	•	•	•	•	•	•	•	•	•	•
Al wrought alloys	≤150 Bhn	•	•	•	•	•	•	•	•	•	•	•
Al cast alloys ≤ 10 % Si	≤200 Bhn	•	•	•	•	•	•	•	•	•	•	•
> 10 % Si	≤200 Bhn	•	•	•	•	•	•	•	•	•	•	•
Magnesium alloys	≤150 Bhn	•	•	•	•	•	•	•	•	•	•	•
Copper, low-alloyed	≤120 Bhn	•	•	•	•	•	•	•	•	•	•	•
Brass, short-chipping	≤200 Bhn	•	•	•	•	•	•	•	•	•	•	•
long-chipping	≤200 Bhn	•	•	•	•	•	•	•	•	•	•	•
Bronze, short-chipping	≤200 Bhn >200-260 Bhn	•	•	•	•	•	•	•	•	•	•	•
Bronze, long-chipping	≤24 Rc >24-30 Rc	•	•	•	•	•	•	•	•	•	•	•
Duroplastics	–	•	•	•	•	•	•	•	•	•	•	•
Thermoplastics	–	65	0.0012	0.0030	0.0050	0.0065	0.0080	•	•	•	•	•
Reinforced plastics - Kevlar	–	•	•	•	•	•	•	•	•	•	•	•
Reinforced plastics - GFK / CFK	–	•	•	•	•	•	•	•	•	•	•	•

Series # 622

Material group	Hardness	SFM	Feed Rate - IPR									
			1/16 in. 1.590 mm	1/8 in. 3.170 mm	1/4 in. 6.350 mm	3/8 in. 9.520 mm	1/2 in. 12.700 mm	5/8 in. 15.870 mm	3/4 in. 19.050 mm	1 in. 25.400 mm	1 1/4 in. 31.750 mm	1 1/2 in. 38.100 mm
Common structural steels	≤100 Bhn >100-260 Bhn	• •	• •	• •	• •	• •	• •	• •	• •	• •	• •	• •
Free-cutting steels	≤24 Rc >24-30 Rc	• 90	• 0.0015	• 0.0040	• 0.0065	• 0.0080	• 0.0100	• •	• •	• •	• •	• •
Unalloyed heat-treatable steels	≤16 Rc 16-24 Rc 24-30 Rc	• 90 45	• 0.0015 0.0012	• 0.0040 0.0030	• 0.0065 0.0050	• 0.0080 0.0065	• 0.0100 0.0080	• • •	• • •	• • •	• • •	• • •
Alloyed heat-treatable steels	24-30 Rc >30-38 Rc	55 45	0.0012 0.0010	0.0030 0.0025	0.0050 0.0040	0.0065 0.0050	0.0080 0.0065	• •	• •	• •	• •	• •
Unalloyed case hardened steels	≤230 Bhn	•	•	•	•	•	•	•	•	•	•	•
Alloyed case hardened steels	24-30 Rc >30-38 Rc	50 35	0.0012 0.0010	0.0030 0.0025	0.0050 0.0040	0.0065 0.0050	0.0080 0.0065	• •	• •	• •	• •	• •
Nitriding steels	≥24-30 Rc >30-38 Rc	45 30	0.0012 0.0010	0.0030 0.0025	0.0050 0.0040	0.0065 0.0050	0.0080 0.0065	• •	• •	• •	• •	• •
Tool steels	≤24 Rc >24-30 Rc	55 30	0.0012 0.0010	0.0030 0.0025	0.0050 0.0040	0.0065 0.0050	0.0080 0.0065	• •	• •	• •	• •	• •
High speed steels	≥14-30 Rc	30	0.0010	0.0025	0.0040	0.0050	0.0065	•	•	•	•	•
Spring steels	≤330 Bhn	•	•	•	•	•	•	•	•	•	•	•
Stainless steels, sulphured austenitic martensitic	≤24 Rc • ≤24 Rc	45 • 35	0.0012 • 0.0010	0.0030 • 0.0025	0.0050 • 0.0040	0.0065 • 0.0050	0.0080 • 0.0065	• • •	• • •	• • •	• • •	• • •
Hardened steels	≤40-48 Rc >48-60 Rc	• •	• •	• •	• •	• •	• •	• •	• •	• •	• •	• •
Special alloys	≤38 Rc	•	•	•	•	•	•	•	•	•	•	•
Cast iron	≤240 Bhn >300 Bhn	115 90	0.0017 0.0017	0.0050 0.0050	0.0080 0.0080	0.0100 0.0100	0.0125 0.0125	• •	• •	• •	• •	• •
Spheroidal graphite iron and malleable cast iron	≤240 Bhn >300 Bhn	95 70	0.0017 0.0017	0.0050 0.0050	0.0080 0.0080	0.0100 0.0100	0.0125 0.0125	• •	• •	• •	• •	• •
Chilled cast iron	≤350 Bhn	25	0.0010	0.0025	0.0040	0.0050	0.0065	•	•	•	•	•
Ti and Ti-alloys	≤24 Rc >24-38 Rc	• •	• •	• •	• •	• •	• •	• •	• •	• •	• •	• •
Aluminium and Al-alloys	≤120 Bhn	•	•	•	•	•	•	•	•	•	•	•
Al wrought alloys	≤150 Bhn	•	•	•	•	•	•	•	•	•	•	•
Al cast alloys ≤ 10 % Si > 10 % Si	≤200 Bhn ≤200 Bhn	225 180	0.0020 0.0017	0.0065 0.0050	0.0100 0.0080	0.0125 0.0100	0.0160 0.0125	• •	• •	• •	• •	• •
Magnesium alloys	≤150 Bhn	•	•	•	•	•	•	•	•	•	•	•
Copper, low-alloyed	≤120 Bhn	115	0.0015	0.0040	0.0065	0.0080	0.0100	•	•	•	•	•
Brass, short-chipping long-chipping	≤200 Bhn ≤200 Bhn	• 145	• 0.0015	• 0.0040	• 0.0065	• 0.0080	• 0.0100	• •	• •	• •	• •	• •
Bronze, short-chipping	≤200 Bhn >200-260 Bhn	• •	• •	• •	• •	• •	• •	• •	• •	• •	• •	• •
Bronze, long-chipping	≤24 Rc >24-30 Rc	90 70	0.0012 0.0012	0.0030 0.0030	0.0050 0.0050	0.0065 0.0065	0.0080 0.0080	• •	• •	• •	• •	• •
Duroplastics Thermoplastics	- -	55 •	0.0012 •	0.0030 •	0.0050 •	0.0065 •	0.0080 •	• •	• •	• •	• •	• •
Reinforced plastics - Kevlar Reinforced plastics - GFK / CFK	- -	• •	• •	• •	• •	• •	• •	• •	• •	• •	• •	• •

Series # 651

Material group	Hardness	SFM	Feed Rate - IPR									
			1/16 in. 1.590 mm	1/8 in. 3.170 mm	1/4 in. 6.350 mm	3/8 in. 9.520 mm	1/2 in. 12.700 mm	5/8 in. 15.870 mm	3/4 in. 19.050 mm	1 in. 25.400 mm	1 1/4 in. 31.750 mm	1 1/2 in. 38.100 mm
Common structural steels	≤100 Bhn >100-260 Bhn	130 100	0.0017 0.0015	0.0050 0.0040	0.0080 0.0065	0.0100 0.0080	0.0125 0.0100	0.0125 0.0100	0.0140 0.0110	• •	• •	• •
Free-cutting steels	≤24 Rc >24-30 Rc	130 100	0.0017 0.0015	0.0050 0.0040	0.0080 0.0065	0.0100 0.0080	0.0125 0.0100	0.0125 0.0100	0.0140 0.0110	• •	• •	• •
Unalloyed heat-treatable steels	≤16 Rc 16-24 Rc 24-30 Rc	130 100 50	0.0015 0.0015 0.0012	0.0040 0.0040 0.0030	0.0065 0.0065 0.0050	0.0080 0.0080 0.0065	0.0100 0.0100 0.0080	0.0100 0.0100 0.0080	0.0110 0.0110 0.0090	• • •	• • •	• • •
Alloyed heat-treatable steels	24-30 Rc >30-38 Rc	65 •	0.0012 •	0.0030 •	0.0050 •	0.0065 •	0.0080 •	0.0080 •	0.0090 •	• •	• •	• •
Unalloyed case hardened steels	≤230 Bhn	130	0.0017	0.0050	0.0080	0.0100	0.0125	0.0125	0.0140	•	•	•
Alloyed case hardened steels	24-30 Rc >30-38 Rc	55 •	0.0012 •	0.0030 •	0.0050 •	0.0065 •	0.0080 •	0.0080 •	0.0090 •	• •	• •	• •
Nitriding steels	≥24-30 Rc >30-38 Rc	45 •	0.0012 •	0.0030 •	0.0050 •	0.0065 •	0.0080 •	0.0080 •	0.0090 •	• •	• •	• •
Tool steels	≤24 Rc >24-30 Rc	65 •	0.0012 •	0.0030 •	0.0050 •	0.0065 •	0.0080 •	0.0080 •	0.0090 •	• •	• •	• •
High speed steels	≥14-30 Rc	•	•	•	•	•	•	•	•	•	•	•
Spring steels	≤330 Bhn	•	•	•	•	•	•	•	•	•	•	•
Stainless steels, sulphured austenitic martensitic	≤24 Rc • ≤24 Rc	• • •	• • •	• • •	• • •	• • •	• • •	• • •	• • •	• • •	• • •	• • •
Hardened steels	≤40-48 Rc >48-60 Rc	• •	• •	• •	• •	• •	• •	• •	• •	• •	• •	• •
Special alloys	≤38 Rc	•	•	•	•	•	•	•	•	•	•	•
Cast iron	≤240 Bhn >300 Bhn	130 100	0.0017 0.0017	0.0050 0.0050	0.0080 0.0080	0.0100 0.0100	0.0125 0.0125	0.0125 0.0140	0.0140 0.0140	• •	• •	• •
Spheroidal graphite iron and malleable cast iron	≤240 Bhn >300 Bhn	115 80	0.0017 0.0017	0.0050 0.0050	0.0080 0.0080	0.0100 0.0100	0.0125 0.0125	0.0125 0.0140	0.0140 0.0140	• •	• •	• •
Chilled cast iron	≤350 Bhn	•	•	•	•	•	•	•	•	•	•	•
Ti and Ti-alloys	≤24 Rc >24-38 Rc	• •	• •	• •	• •	• •	• •	• •	• •	• •	• •	• •
Aluminium and Al-alloys	≤120 Bhn	•	•	•	•	•	•	•	•	•	•	•
Al wrought alloys	≤150 Bhn	•	•	•	•	•	•	•	•	•	•	•
Al cast alloys ≤ 10 % Si > 10 % Si	≤200 Bhn ≤200 Bhn	260 225	0.0020 0.0017	0.0065 0.0050	0.0100 0.0080	0.0125 0.0100	0.0160 0.0125	0.0160 0.0140	0.0180 0.0140	• •	• •	• •
Magnesium alloys	≤150 Bhn	325	0.0017	0.0050	0.0080	0.0100	0.0125	0.0125	0.0140	•	•	•
Copper, low-alloyed	≤120 Bhn	130	0.0015	0.0040	0.0065	0.0080	0.0100	0.0100	0.0110	•	•	•
Brass, short-chipping long-chipping	≤200 Bhn ≤200 Bhn	• 160	• 0.0015	• 0.0040	• 0.0065	• 0.0080	• 0.0100	• 0.0100	• 0.0110	• •	• •	• •
Bronze, short-chipping	≤200 Bhn >200-260 Bhn	130 115	0.0012 0.0012	0.0030 0.0030	0.0050 0.0050	0.0065 0.0065	0.0080 0.0080	0.0080 0.0090	0.0090 0.0090	• •	• •	• •
Bronze, long-chipping	≤24 Rc >24-30 Rc	100 80	0.0012 0.0012	0.0030 0.0030	0.0050 0.0050	0.0065 0.0065	0.0080 0.0080	0.0080 0.0090	0.0090 0.0090	• •	• •	• •
Duroplastics Thermoplastics	- -	65 100	0.0012 0.0015	0.0030 0.0040	0.0050 0.0065	0.0065 0.0080	0.0080 0.0100	0.0080 0.0110	0.0090 0.0110	• •	• •	• •
Reinforced plastics - Kevlar Reinforced plastics - GFK / CFK	- -	• •	• •	• •	• •	• •	• •	• •	• •	• •	• •	• •

$$\text{RPM} = \frac{\text{SFM}}{\text{DIAM. in.}} \times 3.82 \quad \text{IPM} = \text{IPR} \times \text{RPM}$$

$$\frac{\text{HOLE DEPTH in.}}{\text{IPM}} \times 60 = \text{Cut Time}$$

$$\text{mm} = \text{in.} \times 25.40$$

$$\text{m/min.} = \text{SFM} \div 3.28$$

$$\text{mm/rev.} = \text{IPR} \times 25.40$$

$$\text{Bar} = \text{PSI} \div 14.50$$

$$\text{Liter} = \text{Gal.} \div 3.79$$

Series # 652

Material group	Hardness	SFM	Feed Rate - IPR									
			1/16 in. 1.590 mm	1/8 in. 3.170 mm	1/4 in. 6.350 mm	3/8 in. 9.520 mm	1/2 in. 12.700 mm	5/8 in. 15.870 mm	3/4 in. 19.050 mm	1 in. 25.400 mm	1 1/4 in. 31.750 mm	1 1/2 in. 38.100 mm
Common structural steels	≤100 Bhn >100-260 Bhn	130 100	0.0017 0.0015	0.0050 0.0040	0.0080 0.0065	0.0100 0.0080	0.0125 0.0100	0.0125 0.0100	*	*	*	*
Free-cutting steels	≤24 Rc >24-30 Rc	130 100	0.0017 0.0015	0.0050 0.0040	0.0080 0.0065	0.0100 0.0080	0.0125 0.0100	0.0125 0.0100	*	*	*	*
Unalloyed heat-treatable steels	≤16 Rc 16-24 Rc 24-30 Rc	130 100 50	0.0015 0.0015 0.0012	0.0040 0.0040 0.0030	0.0065 0.0065 0.0050	0.0080 0.0080 0.0065	0.0100 0.0100 0.0080	0.0100 0.0100 0.0080	*	*	*	*
Alloyed heat-treatable steels	24-30 Rc >30-38 Rc	65 *	0.0012 *	0.0030 *	0.0050 *	0.0065 *	0.0080 *	0.0080 *	*	*	*	*
Unalloyed case hardened steels	≤230 Bhn	130	0.0017	0.0050	0.0080	0.0100	0.0125	0.0125	*	*	*	*
Alloyed case hardened steels	24-30 Rc >30-38 Rc	55 *	0.0012 *	0.0030 *	0.0050 *	0.0065 *	0.0080 *	0.0080 *	*	*	*	*
Nitriding steels	≥24-30 Rc >30-38 Rc	45 *	0.0012 *	0.0030 *	0.0050 *	0.0065 *	0.0080 *	0.0080 *	*	*	*	*
Tool steels	≤24 Rc >24-30 Rc	65 *	0.0012 *	0.0030 *	0.0050 *	0.0065 *	0.0080 *	0.0080 *	*	*	*	*
High speed steels	≥14-30 Rc	*	*	*	*	*	*	*	*	*	*	*
Spring steels	≤330 Bhn	*	*	*	*	*	*	*	*	*	*	*
Stainless steels, sulphured austenitic martensitic	≤24 Rc * ≤24 Rc * ≤24 Rc	*	*	*	*	*	*	*	*	*	*	*
Hardened steels	≤40-48 Rc >48-60 Rc	*	*	*	*	*	*	*	*	*	*	*
Special alloys	≤38 Rc	*	*	*	*	*	*	*	*	*	*	*
Cast iron	≤240 Bhn >300 Bhn	130 100	0.0017 0.0017	0.0050 0.0050	0.0080 0.0080	0.0100 0.0100	0.0125 0.0125	0.0125 0.0125	*	*	*	*
Spheroidal graphite iron and malleable cast iron	≤240 Bhn >300 Bhn	115 80	0.0017 0.0017	0.0050 0.0050	0.0080 0.0080	0.0100 0.0100	0.0125 0.0125	0.0125 0.0125	*	*	*	*
Chilled cast iron	≤350 Bhn	*	*	*	*	*	*	*	*	*	*	*
Ti and Ti-alloys	≤24 Rc >24-38 Rc	*	*	*	*	*	*	*	*	*	*	*
Aluminium and Al-alloys	≤120 Bhn	*	*	*	*	*	*	*	*	*	*	*
Al wrought alloys	≤150 Bhn	*	*	*	*	*	*	*	*	*	*	*
Al cast alloys ≤ 10 % Si	≤200 Bhn	260	0.0020	0.0065	0.0100	0.0125	0.0160	0.0160	*	*	*	*
> 10 % Si	≤200 Bhn	225	0.0017	0.0050	0.0080	0.0100	0.0125	0.0125	*	*	*	*
Magnesium alloys	≤150 Bhn	*	*	*	*	*	*	*	*	*	*	*
Copper, low-alloyed	≤120 Bhn	130	0.0015	0.0040	0.0065	0.0080	0.0100	0.0100	*	*	*	*
Brass, short-chipping long-chipping	≤200 Bhn * ≤200 Bhn	160 *	0.0015 *	0.0040 *	0.0065 *	0.0080 *	0.0100 *	0.0100 *	*	*	*	*
Bronze, short-chipping	≤200 Bhn * >200-260 Bhn	160 *	0.0015 *	0.0040 *	0.0065 *	0.0080 *	0.0100 *	0.0100 *	*	*	*	*
Bronze, long-chipping	≤24 Rc >24-30 Rc	100 80	0.0012 0.0012	0.0030 0.0030	0.0050 0.0050	0.0065 0.0065	0.0080 0.0080	0.0080 0.0080	*	*	*	*
Duroplastics	-	65	0.0012	0.0030	0.0050	0.0065	0.0080	0.0080	*	*	*	*
Thermoplastics	-	*	*	*	*	*	*	*	*	*	*	*
Reinforced plastics - Kevlar	-	*	*	*	*	*	*	*	*	*	*	*
Reinforced plastics - GFK / CFK	-	*	*	*	*	*	*	*	*	*	*	*

Series # 653

Material group	Hardness	SFM	Feed Rate - IPR									
			1/16 in. 1.590 mm	1/8 in. 3.170 mm	1/4 in. 6.350 mm	3/8 in. 9.520 mm	1/2 in. 12.700 mm	5/8 in. 15.870 mm	3/4 in. 19.050 mm	1 in. 25.400 mm	1 1/4 in. 31.750 mm	1 1/2 in. 38.100 mm
Common structural steels	≤100 Bhn >100-260 Bhn	145 115	0.0017 0.0015	0.0050 0.0040	0.0080 0.0065	0.0100 0.0080	0.0125 0.0100	0.0125 0.0100	0.0140 0.0110	0.0160 0.0125	0.0200 0.0160	*
Free-cutting steels	≤24 Rc >24-30 Rc	145 115	0.0017 0.0015	0.0050 0.0040	0.0080 0.0065	0.0100 0.0080	0.0125 0.0100	0.0125 0.0100	0.0140 0.0110	0.0160 0.0125	0.0200 0.0160	*
Unalloyed heat-treatable steels	≤16 Rc 16-24 Rc 24-30 Rc	145 100 55	0.0015 0.0015 0.0012	0.0040 0.0040 0.0030	0.0065 0.0065 0.0050	0.0080 0.0080 0.0065	0.0100 0.0100 0.0080	0.0100 0.0100 0.0080	0.0110 0.0110 0.0090	0.0125 0.0125 0.0100	0.0160 0.0160 0.0125	*
Alloyed heat-treatable steels	24-30 Rc >30-38 Rc	70 *	0.0012 *	0.0030 *	0.0050 *	0.0065 *	0.0080 *	0.0080 *	0.0090 *	0.0100 *	0.0125 *	*
Unalloyed case hardened steels	≤230 Bhn	145	0.0017	0.0050	0.0080	0.0100	0.0125	0.0125	0.0140	0.0160	0.0200	*
Alloyed case hardened steels	24-30 Rc >30-38 Rc	65 *	0.0012 *	0.0030 *	0.0050 *	0.0065 *	0.0080 *	0.0080 *	0.0090 *	0.0100 *	0.0125 *	*
Nitriding steels	≥24-30 Rc >30-38 Rc	55 *	0.0012 *	0.0030 *	0.0050 *	0.0065 *	0.0080 *	0.0080 *	0.0090 *	0.0100 *	0.0125 *	*
Tool steels	≤24 Rc >24-30 Rc	70 *	0.0012 *	0.0030 *	0.0050 *	0.0065 *	0.0080 *	0.0080 *	0.0090 *	0.0100 *	0.0125 *	*
High speed steels	≥14-30 Rc	*	*	*	*	*	*	*	*	*	*	*
Spring steels	≤330 Bhn	*	*	*	*	*	*	*	*	*	*	*
Stainless steels, sulphured austenitic martensitic	≤24 Rc * ≤24 Rc * ≤24 Rc	*	*	*	*	*	*	*	*	*	*	*
Hardened steels	≤40-48 Rc >48-60 Rc	*	*	*	*	*	*	*	*	*	*	*
Special alloys	≤38 Rc	*	*	*	*	*	*	*	*	*	*	*
Cast iron	≤240 Bhn >300 Bhn	145 115	0.0017 0.0017	0.0050 0.0050	0.0080 0.0080	0.0100 0.0100	0.0125 0.0125	0.0125 0.0125	0.0140 0.0140	0.0160 0.0160	0.0200 0.0200	*
Spheroidal graphite iron and malleable cast iron	≤240 Bhn >300 Bhn	130 90	0.0017 0.0017	0.0050 0.0050	0.0080 0.0080	0.0100 0.0100	0.0125 0.0125	0.0125 0.0125	0.0140 0.0140	0.0160 0.0160	0.0200 0.0200	*
Chilled cast iron	≤350 Bhn	*	*	*	*	*	*	*	*	*	*	*
Ti and Ti-alloys	≤24 Rc >24-38 Rc	*	*	*	*	*	*	*	*	*	*	*
Aluminium and Al-alloys	≤120 Bhn	*	*	*	*	*	*	*	*	*	*	*
Al wrought alloys	≤150 Bhn	*	*	*	*	*	*	*	*	*	*	*
Al cast alloys ≤ 10 % Si	≤200 Bhn	295	0.0020	0.0065	0.0100	0.0125	0.0160	0.0160	0.0180	0.0200	0.0245	*
> 10 % Si	≤200 Bhn	260	0.0017	0.0050	0.0080	0.0100	0.0125	0.0125	0.0140	0.0160	0.0200	*
Magnesium alloys	≤150 Bhn	*	*	*	*	*	*	*	*	*	*	*
Copper, low-alloyed	≤120 Bhn	145	0.0015	0.0040	0.0065	0.0080	0.0100	0.0100	0.0110	0.0125	0.0160	*
Brass, short-chipping long-chipping	≤200 Bhn * ≤200 Bhn	180 *	0.0015 *	0.0040 *	0.0065 *	0.0080 *	0.0100 *	0.0100 *	0.0110 *	0.0125 *	0.0160 *	*
Bronze, short-chipping	≤200 Bhn * >200-260 Bhn	145 130	0.0012 0.0012	0.0030 0.0030	0.0050 0.0050	0.0065 0.0065	0.0080 0.0080	0.0080 0.0090	0.0090 0.0100	0.0100 0.0100	0.0125 0.0125	*
Bronze, long-chipping	≤24 Rc >24-30 Rc	110 90	0.0012 0.0012	0.0030 0.0030	0.0050 0.0050	0.0065 0.0065	0.0080 0.0080	0.0080 0.0090	0.0090 0.0100	0.0100 0.0100	0.0125 0.0125	*
Duroplastics	-	70	0.0012	0.0030	0.0050	0.0065	0.0080	0.0080	0.0090	0.0100	0.0125	*
Thermoplastics	-	115	0.0015	0.0040	0.0065	0.0080	0.0100	0.0100	0.0110	0.0125	0.0160	*
Reinforced plastics - Kevlar	-	*	*	*	*	*	*	*	*	*	*	*
Reinforced plastics - GFK / CFK	-	*	*	*	*	*	*	*	*	*	*	*

RPM = $\frac{SFM}{DIAM. \text{ in.}} \times 3.82$ IPM = IPR x RPM

HOLE DEPTH in. x 60 = Cut Time IPM mm = in. x 25.40

m/min. = SFM ÷ 3.28 Bar = PSI ÷ 14.50
mm/rev. = IPR x 25.40 Liter = Gal. ÷ 3.79

Series # 670

Material group	Hardness	SFM	Feed Rate - IPR										
			1/16 in. 1.590 mm	1/8 in. 3.170 mm	1/4 in. 6.350 mm	3/8 in. 9.520 mm	1/2 in. 12.700 mm	5/8 in. 15.870 mm	3/4 in. 19.050 mm	1 in. 25.400 mm	1 1/4 in. 31.750 mm	1 1/2 in. 38.100 mm	
Common structural steels	≤100 Bhn >100-260 Bhn	90 70	0.0015 0.0012	0.0040 0.0030	0.0065 0.0050	0.0080 0.0065	0.0100 0.0080	•	•	•	•	•	•
Free-cutting steels	≤24 Rc >24-30 Rc	90 70	0.0015 0.0012	0.0040 0.0030	0.0065 0.0050	0.0080 0.0065	0.0100 0.0080	•	•	•	•	•	•
Unalloyed heat-treatable steels	≤16 Rc 16-24 Rc 24-30 Rc	90 70 50	0.0012 0.0012 0.0010	0.0030 0.0030 0.0025	0.0050 0.0050 0.0040	0.0065 0.0065 0.0050	0.0080 0.0080 0.0065	•	•	•	•	•	•
Alloyed heat-treatable steels	24-30 Rc >30-38 Rc	45 30	0.0010 0.0007	0.0025 0.0020	0.0040 0.0030	0.0050 0.0040	0.0065 0.0050	•	•	•	•	•	•
Unalloyed case hardened steels	≤230 Bhn	90	0.0015	0.0040	0.0065	0.0080	0.0100	•	•	•	•	•	•
Alloyed case hardened steels	24-30 Rc >30-38 Rc	35 30	0.0010 0.0007	0.0025 0.0020	0.0040 0.0030	0.0050 0.0040	0.0065 0.0050	•	•	•	•	•	•
Nitriding steels	≥24-30 Rc >30-38 Rc	30 25	0.0010 0.0007	0.0025 0.0020	0.0040 0.0030	0.0050 0.0040	0.0065 0.0050	•	•	•	•	•	•
Tool steels	≤24 Rc >24-30 Rc	35 25	0.0010 0.0007	0.0025 0.0020	0.0040 0.0030	0.0050 0.0040	0.0065 0.0050	•	•	•	•	•	•
High speed steels	≥14-30 Rc	25	0.0007	0.0020	0.0030	0.0040	0.0050	•	•	•	•	•	•
Spring steels	≤330 Bhn	15	0.0005	0.0015	0.0025	0.0030	0.0040	•	•	•	•	•	•
Stainless steels, sulphured austenitic martensitic	≤24 Rc 25 ≤24 Rc	30 25 30	0.0010 0.0007 0.0007	0.0025 0.0020 0.0020	0.0040 0.0030 0.0030	0.0050 0.0040 0.0040	0.0065 0.0050 0.0050	•	•	•	•	•	•
Hardened steels	≤40-48 Rc >48-60 Rc	• •	• •	• •	• •	• •	• •	•	•	•	•	•	•
Special alloys	≤38 Rc	15	0.0005	0.0015	0.0025	0.0030	0.0040	•	•	•	•	•	•
Cast iron	≤240 Bhn <300 Bhn	90 70	0.0015 0.0015	0.0040 0.0040	0.0065 0.0065	0.0080 0.0080	0.0100 0.0100	•	•	•	•	•	•
Spheroidal graphite iron and malleable cast iron	≤240 Bhn <300 Bhn	80 55	0.0015 0.0015	0.0040 0.0040	0.0065 0.0065	0.0080 0.0080	0.0100 0.0100	•	•	•	•	•	•
Chilled cast iron	≤350 Bhn	15	0.0007	0.0020	0.0030	0.0040	0.0050	•	•	•	•	•	•
Ti and Ti-alloys	≤24 Rc >24-38 Rc	25 15	0.0005 0.0005	0.0015 0.0015	0.0025 0.0025	0.0030 0.0030	0.0040 0.0040	•	•	•	•	•	•
Aluminium and Al-alloys	≤120 Bhn	225	0.0017	0.0050	0.0080	0.0100	0.0125	•	•	•	•	•	•
Al wrought alloys	≤150 Bhn	225	0.0017	0.0050	0.0080	0.0100	0.0125	•	•	•	•	•	•
Al cast alloys ≤ 10 % Si	≤200 Bhn	180	0.0017	0.0050	0.0080	0.0100	0.0125	•	•	•	•	•	•
> 10 % Si	≤200 Bhn	145	0.0015	0.0040	0.0065	0.0080	0.0100	•	•	•	•	•	•
Magnesium alloys	≤150 Bhn	225	0.0015	0.0040	0.0065	0.0080	0.0100	•	•	•	•	•	•
Copper, low-alloyed	≤120 Bhn	90	0.0012	0.0030	0.0050	0.0065	0.0080	•	•	•	•	•	•
Brass, short-chipping long-chipping	≤200 Bhn ≤200 Bhn	• 115	• 0.0012	• 0.0030	• 0.0050	• 0.0065	• 0.0080	•	•	•	•	•	•
Bronze, short-chipping	≤200 Bhn >200-260 Bhn	90 80	0.0010 0.0010	0.0025 0.0025	0.0040 0.0040	0.0050 0.0050	0.0065 0.0065	•	•	•	•	•	•
Bronze, long-chipping	≤24 Rc >24-30 Rc	70 55	0.0010 0.0010	0.0025 0.0025	0.0040 0.0040	0.0050 0.0050	0.0065 0.0065	•	•	•	•	•	•
Duroplastics	-	45	0.0010	0.0025	0.0040	0.0050	0.0065	•	•	•	•	•	•
Thermoplastics	-	70	0.0012	0.0030	0.0050	0.0065	0.0080	•	•	•	•	•	•
Reinforced plastics - Kevlar	-	•	•	•	•	•	•	•	•	•	•	•	•
Reinforced plastics - GFK / CFK	-	•	•	•	•	•	•	•	•	•	•	•	•

Series # 671

Material group	Hardness	SFM	Feed Rate - IPR										
			1/16 in. 1.590 mm	1/8 in. 3.170 mm	1/4 in. 6.350 mm	3/8 in. 9.520 mm	1/2 in. 12.700 mm	5/8 in. 15.870 mm	3/4 in. 19.050 mm	1 in. 25.400 mm	1 1/4 in. 31.750 mm	1 1/2 in. 38.100 mm	
Common structural steels	≤100 Bhn >100-260 Bhn	90 70	0.0015 0.0012	0.0040 0.0030	0.0065 0.0050	0.0080 0.0065	0.0100 0.0080	•	•	•	•	•	•
Free-cutting steels	≤24 Rc >24-30 Rc	90 70	0.0015 0.0012	0.0040 0.0030	0.0065 0.0050	0.0080 0.0065	0.0100 0.0080	•	•	•	•	•	•
Unalloyed heat-treatable steels	≤16 Rc 16-24 Rc 24-30 Rc	90 70 50	0.0012 0.0012 0.0010	0.0030 0.0030 0.0025	0.0050 0.0050 0.0040	0.0065 0.0065 0.0050	0.0080 0.0080 0.0065	•	•	•	•	•	•
Alloyed heat-treatable steels	24-30 Rc >30-38 Rc	45 30	0.0010 0.0007	0.0025 0.0020	0.0040 0.0030	0.0050 0.0040	0.0065 0.0050	•	•	•	•	•	•
Unalloyed case hardened steels	≤230 Bhn	90	0.0015	0.0040	0.0065	0.0080	0.0100	•	•	•	•	•	•
Alloyed case hardened steels	24-30 Rc >30-38 Rc	35 30	0.0010 0.0007	0.0025 0.0020	0.0040 0.0030	0.0050 0.0040	0.0065 0.0050	•	•	•	•	•	•
Nitriding steels	≥24-30 Rc >30-38 Rc	30 25	0.0010 0.0007	0.0025 0.0020	0.0040 0.0030	0.0050 0.0040	0.0065 0.0050	•	•	•	•	•	•
Tool steels	≤24 Rc >24-30 Rc	35 25	0.0010 0.0007	0.0025 0.0020	0.0040 0.0030	0.0050 0.0040	0.0065 0.0050	•	•	•	•	•	•
High speed steels	≥14-30 Rc	25	0.0007	0.0020	0.0030	0.0040	0.0050	•	•	•	•	•	•
Spring steels	≤330 Bhn	15	0.0005	0.0015	0.0025	0.0030	0.0040	•	•	•	•	•	•
Stainless steels, sulphured austenitic martensitic	≤24 Rc 25 ≤24 Rc	30 25 30	0.0010 0.0007 0.0007	0.0025 0.0020 0.0020	0.0040 0.0030 0.0030	0.0050 0.0040 0.0040	0.0065 0.0050 0.0050	•	•	•	•	•	•
Hardened steels	≤40-48 Rc >48-60 Rc	• •	• •	• •	• •	• •	• •	•	•	•	•	•	•
Special alloys	≤38 Rc	15	0.0005	0.0015	0.0025	0.0030	0.0040	•	•	•	•	•	•
Cast iron	≤240 Bhn <300 Bhn	90 70	0.0015 0.0015	0.0040 0.0040	0.0065 0.0065	0.0080 0.0080	0.0100 0.0100	•	•	•	•	•	•
Spheroidal graphite iron and malleable cast iron	≤240 Bhn <300 Bhn	80 55	0.0015 0.0015	0.0040 0.0040	0.0065 0.0065	0.0080 0.0080	0.0100 0.0100	•	•	•	•	•	•
Chilled cast iron	≤350 Bhn	15	0.0007	0.0020	0.0030	0.0040	0.0050	•	•	•	•	•	•
Ti and Ti-alloys	≤24 Rc >24-38 Rc	25 15	0.0005 0.0005	0.0015 0.0015	0.0025 0.0025	0.0030 0.0030	0.0040 0.0040	•	•	•	•	•	•
Aluminium and Al-alloys	≤120 Bhn	225	0.0017	0.0050	0.0080	0.0100	0.0125	•	•	•	•	•	•
Al wrought alloys	≤150 Bhn	225	0.0017	0.0050	0.0080	0.0100	0.0125	•	•	•	•	•	•
Al cast alloys ≤ 10 % Si	≤200 Bhn	180	0.0017	0.0050	0.0080	0.0100	0.0125	•	•	•	•	•	•
> 10 % Si	≤200 Bhn	145	0.0015	0.0040	0.0065	0.0080	0.0100	•	•	•	•	•	•
Magnesium alloys	≤150 Bhn	225	0.0015	0.0040	0.0065	0.0080	0.0100	•	•	•	•	•	•
Copper, low-alloyed	≤120 Bhn	90	0.0012	0.0030	0.0050	0.0065	0.0080	•	•	•	•	•	•
Brass, short-chipping long-chipping	≤200 Bhn ≤200 Bhn	• 115	• 0.0012	• 0.0030	• 0.0050	• 0.0065	• 0.0080	•	•	•	•	•	•
Bronze, short-chipping	≤200 Bhn >200-260 Bhn	90 80	0.0010 0.0010	0.0025 0.0025	0.0040 0.0040	0.0050 0.0050	0.0065 0.0065	•	•	•	•	•	•
Bronze, long-chipping	≤24 Rc >24-30 Rc	70 55	0.0010 0.0010	0.0025 0.0025	0.0040 0.0040	0.0050 0.0050	0.0065 0.0065	•	•	•	•	•	•
Duroplastics	-	45	0.0010	0.0025	0.0040	0.0050	0.0065	•	•	•	•	•	•
Thermoplastics	-	70	0.0012	0.0030	0.0050	0.0065	0.0080	•	•	•	•	•	•
Reinforced plastics - Kevlar	-	•	•	•	•	•	•	•	•	•	•	•	•
Reinforced plastics - GFK / CFK	-	•	•	•	•	•	•	•	•	•	•	•	•

Using These Tables. The Speeds & Feeds listed below are conservative recommendations for initial setup. In actual use, depending on the machining environment and workpiece material, significantly higher speeds and feeds may be achievable. Using the below as a starting point, cutting speed/feed can be gradually adjusted upwards until the optimum settings per application are found.
 Questions? Contact us by telephone at (800) 776-6170.

Series # 730

Material group	Hardness	SFM	Feed Rate - IPR									
			1/16 in. 1.590 mm	1/8 in. 3.170 mm	1/4 in. 6.350 mm	3/8 in. 9.520 mm	1/2 in. 12.700 mm	5/8 in. 15.870 mm	3/4 in. 19.050 mm	1 in. 25.400 mm	1 1/4 in. 31.750 mm	1 1/2 in. 38.100 mm
Common structural steels	≤100 Bhn >100-260 Bhn	260 225	0.0012 0.0012	0.0030 0.0030	0.0050 0.0050	0.0065 0.0065	0.0080 0.0080	0.0080 0.0080	•	•	•	•
Free-cutting steels	≤24 Rc >24-30 Rc	260 225	0.0015 0.0012	0.0040 0.0030	0.0065 0.0050	0.0080 0.0065	0.0100 0.0080	0.0100 0.0080	•	•	•	•
Unalloyed heat-treatable steels	≤16 Rc 16-24 Rc 24-30 Rc	260 225 195	0.0012 0.0012 0.0012	0.0030 0.0030 0.0030	0.0050 0.0050 0.0050	0.0065 0.0065 0.0065	0.0080 0.0080 0.0080	0.0080 0.0080 0.0080	•	•	•	•
Alloyed heat-treatable steels	24-30 Rc >30-38 Rc	195 •	0.0012 •	0.0030 •	0.0050 •	0.0065 •	0.0080 •	0.0080 •	•	•	•	•
Unalloyed case hardened steels	≤230 Bhn	260	0.0015	0.0040	0.0065	0.0080	0.0100	0.0100	•	•	•	•
Alloyed case hardened steels	24-30 Rc >30-38 Rc	195 •	0.0012 •	0.0030 •	0.0050 •	0.0065 •	0.0080 •	0.0080 •	•	•	•	•
Nitriding steels	≥24-30 Rc >30-38 Rc	160 •	0.0012 •	0.0030 •	0.0050 •	0.0065 •	0.0080 •	0.0080 •	•	•	•	•
Tool steels	≤24 Rc >24-30 Rc	160 •	0.0010 •	0.0025 •	0.0040 •	0.0050 •	0.0065 •	0.0065 •	•	•	•	•
High speed steels	≥14-30 Rc	•	•	•	•	•	•	•	•	•	•	•
Spring steels	≤330 Bhn	80	0.0007	0.0020	0.0030	0.0040	0.0050	0.0050	•	•	•	•
Stainless steels, sulphured	≤24 Rc	80	0.0012	0.0030	0.0050	0.0065	0.0080	0.0080	•	•	•	•
Stainless steels, austenitic	≤24 Rc	80	0.0010	0.0025	0.0040	0.0050	0.0065	0.0065	•	•	•	•
Stainless steels, martensitic	≤24 Rc	80	0.0010	0.0025	0.0040	0.0050	0.0065	0.0065	•	•	•	•
Hardened steels	≤40-48 Rc >48-60 Rc	65 •	0.0010 •	0.0025 •	0.0040 •	0.0050 •	0.0065 •	0.0065 •	•	•	•	•
Special alloys	≤38 Rc	45	0.0007	0.0020	0.0030	0.0040	0.0050	0.0050	•	•	•	•
Cast iron	≤240 Bhn >240-300 Bhn	295 260	0.0012 0.0012	0.0030 0.0030	0.0050 0.0050	0.0065 0.0065	0.0080 0.0080	0.0080 0.0080	•	•	•	•
Spheroidal graphite iron and malleable cast iron	≤240 Bhn >240 Bhn	225 260	0.0012 0.0012	0.0030 0.0030	0.0050 0.0050	0.0065 0.0065	0.0080 0.0080	0.0080 0.0080	•	•	•	•
Chilled cast iron	≤350 Bhn	•	•	•	•	•	•	•	•	•	•	•
Ti and Ti-alloys	≤24 Rc >24-38 Rc	65 45	0.0010 0.0007	0.0025 0.0020	0.0040 0.0030	0.0050 0.0040	0.0065 0.0050	0.0065 0.0050	•	•	•	•
Aluminium and Al-alloys	≤120 Bhn	655	0.0020	0.0065	0.0100	0.0125	0.0160	0.0160	•	•	•	•
Al wrought alloys	≤150 Bhn	655	0.0020	0.0065	0.0100	0.0125	0.0160	0.0160	•	•	•	•
Al cast alloys ≤ 10 % Si	≤200 Bhn	490	0.0017	0.0050	0.0080	0.0100	0.0125	0.0125	•	•	•	•
Al cast alloys > 10 % Si	≤200 Bhn	390	0.0017	0.0050	0.0080	0.0100	0.0125	0.0125	•	•	•	•
Magnesium alloys	≤150 Bhn	590	0.0015	0.0040	0.0065	0.0080	0.0100	0.0100	•	•	•	•
Copper, low-alloyed	≤120 Bhn	260	0.0015	0.0040	0.0065	0.0080	0.0100	0.0100	•	•	•	•
Brass, short-chipping	≤200 Bhn	590	0.0015	0.0040	0.0065	0.0080	0.0100	0.0100	•	•	•	•
Brass, long-chipping	≤200 Bhn	590	0.0015	0.0040	0.0065	0.0080	0.0100	0.0100	•	•	•	•
Bronze, short-chipping	≤200 Bhn >200-260 Bhn	390 390	0.0015 0.0015	0.0040 0.0040	0.0065 0.0065	0.0080 0.0080	0.0100 0.0100	0.0100 0.0100	•	•	•	•
Bronze, long-chipping	≤24 Rc >24-30 Rc	225 160	0.0012 0.0010	0.0030 0.0025	0.0050 0.0040	0.0065 0.0050	0.0080 0.0065	0.0080 0.0065	•	•	•	•
Duroplastics	-	160	•	•	•	•	•	•	•	•	•	•
Thermoplastics	-	130	0.0012	0.0030	0.0050	0.0065	0.0080	0.0080	•	•	•	•
Reinforced plastics - Kevlar	-	•	•	•	•	•	•	•	•	•	•	•
Reinforced plastics - GFK / CFK	-	260	0.0010	0.0025	0.0040	0.0050	0.0065	0.0065	•	•	•	•

Series # 732

Material group	Hardness	SFM	Feed Rate - IPR									
			1/16 in. 1.590 mm	1/8 in. 3.170 mm	1/4 in. 6.350 mm	3/8 in. 9.520 mm	1/2 in. 12.700 mm	5/8 in. 15.870 mm	3/4 in. 19.050 mm	1 in. 25.400 mm	1 1/4 in. 31.750 mm	1 1/2 in. 38.100 mm
Common structural steels	≤100 Bhn >100-260 Bhn	260 225	0.0012 0.0012	0.0030 0.0030	0.0050 0.0050	0.0065 0.0065	0.0080 0.0080	0.0080 0.0080	•	•	•	•
Free-cutting steels	≤24 Rc >24-30 Rc	190 185	0.0015 0.0012	0.0040 0.0030	0.0065 0.0050	0.0080 0.0065	0.0100 0.0080	0.0100 0.0080	•	•	•	•
Unalloyed heat-treatable steels	≤16 Rc 16-24 Rc 24-30 Rc	230 185 100	0.0012 0.0012 0.0012	0.0030 0.0030 0.0030	0.0050 0.0050 0.0050	0.0065 0.0065 0.0065	0.0080 0.0080 0.0080	0.0080 0.0080 0.0080	•	•	•	•
Alloyed heat-treatable steels	24-30 Rc >30-38 Rc	120 90	0.0012 0.0010	0.0030 0.0025	0.0050 0.0040	0.0065 0.0050	0.0080 0.0065	0.0080 0.0065	•	•	•	•
Unalloyed case hardened steels	≤230 Bhn	260	0.0015	0.0040	0.0065	0.0080	0.0100	0.0100	•	•	•	•
Alloyed case hardened steels	24-30 Rc >30-38 Rc	105 80	0.0012 0.0020	0.0030 0.0020	0.0050 0.0030	0.0065 0.0040	0.0080 0.0050	0.0080 0.0050	•	•	•	•
Nitriding steels	≥24-30 Rc >30-38 Rc	90 •	0.0012 •	0.0030 •	0.0050 •	0.0065 •	0.0080 •	0.0080 •	•	•	•	•
Tool steels	≤24 Rc >24-30 Rc	120 •	0.0010 •	0.0025 •	0.0040 •	0.0050 •	0.0065 •	0.0065 •	•	•	•	•
High speed steels	≥14-30 Rc	•	•	•	•	•	•	•	•	•	•	•
Spring steels	≤330 Bhn	•	•	•	•	•	•	•	•	•	•	•
Stainless steels, sulphured	≤24 Rc	80	0.0012	0.0030	0.0050	0.0065	0.0080	0.0080	•	•	•	•
Stainless steels, austenitic	≤24 Rc	80	0.0010	0.0025	0.0040	0.0050	0.0065	0.0065	•	•	•	•
Stainless steels, martensitic	≤24 Rc	80	0.0010	0.0025	0.0040	0.0050	0.0065	0.0065	•	•	•	•
Hardened steels	≤40-48 Rc >48-60 Rc	65 •	0.0010 •	0.0025 •	0.0040 •	0.0050 •	0.0065 •	0.0065 •	•	•	•	•
Special alloys	≤38 Rc	45	0.0020	0.0020	0.0030	0.0040	0.0050	0.0050	•	•	•	•
Cast iron	≤240 Bhn >240-300 Bhn	235 185	0.0012 0.0012	0.0030 0.0030	0.0050 0.0050	0.0065 0.0065	0.0080 0.0080	0.0080 0.0080	•	•	•	•
Spheroidal graphite iron and malleable cast iron	≤240 Bhn >240 Bhn	200 145	0.0012 0.0012	0.0030 0.0030	0.0050 0.0050	0.0065 0.0065	0.0080 0.0080	0.0080 0.0080	•	•	•	•
Chilled cast iron	≤350 Bhn	50	0.0020	0.0020	0.0030	0.0040	0.0050	0.0050	•	•	•	•
Ti and Ti-alloys	≤24 Rc >24-38 Rc	50 40	0.0010 0.0020	0.0025 0.0020	0.0040 0.0030	0.0050 0.0040	0.0065 0.0050	0.0065 0.0050	•	•	•	•
Aluminium and Al-alloys	≤120 Bhn	460	0.0017	0.0050	0.0080	0.0100	0.0125	0.0125	•	•	•	•
Al wrought alloys	≤150 Bhn	360	0.0015	0.0040	0.0065	0.0080	0.0100	0.0100	•	•	•	•
Al cast alloys ≤ 10 % Si	≤200 Bhn	460	0.0017	0.0050	0.0080	0.0100	0.0125	0.0125	•	•	•	•
Al cast alloys > 10 % Si	≤200 Bhn	360	0.0015	0.0040	0.0065	0.0080	0.0100	0.0100	•	•	•	•
Magnesium alloys	≤150 Bhn	390	0.0015	0.0040	0.0065	0.0080	0.0100	0.0100	•	•	•	•
Copper, low-alloyed	≤120 Bhn	260	0.0015	0.0040	0.0065	0.0080	0.0100	0.0100	•	•	•	•
Brass, short-chipping	≤200 Bhn	300	0.0015	0.0040	0.0065	0.0080	0.0100	0.0100	•	•	•	•
Brass, long-chipping	≤200 Bhn	295	0.0015	0.0040	0.0065	0.0080	0.0100	0.0100	•	•	•	•
Bronze, short-chipping	≤200 Bhn >200-260 Bhn	290 280	0.0015 0.0015	0.0040 0.0040	0.0065 0.0065	0.0080 0.0080	0.0100 0.0100	0.0100 0.0100	•	•	•	•
Bronze, long-chipping	≤24 Rc >24-30 Rc	225 160	0.0012 0.0010	0.0030 0.0025	0.0050 0.0040	0.0065 0.0050	0.0080 0.0065	0.0080 0.0065	•	•	•	•
Duroplastics	-	130	0.0012	0.0030	0.0050	0.0065	0.0080	0.0080	•	•	•	•
Thermoplastics	-	160	0.0010	0.0025	0.0040	0.0050	0.0065	0.0065	•	•	•	•
Reinforced plastics - Kevlar	-	•	•	•	•	•	•	•	•	•	•	•
Reinforced plastics - GFK / CFK	-	260	0.0010	0.0025	0.0040	0.0050	0.0065	0.0065	•	•	•	•

$$\text{RPM} = \frac{\text{SFM}}{\text{DIAM. in.}} \times 3.82 \quad \text{IPM} = \text{IPR} \times \text{RPM}$$

$$\frac{\text{HOLE DEPTH in.}}{\text{IPM}} \times 60 = \text{Cut Time} \quad \text{mm} = \text{in.} \times 25.40$$

$$\text{m/min.} = \text{SFM} \div 3.28 \quad \text{Bar} = \text{PSI} \div 14.50$$

$$\text{mm/rev.} = \text{IPR} \times 25.40 \quad \text{Liter} = \text{Gal.} \div 3.79$$

Series # 768

Material group	Hardness	SFM	Feed Rate - IPR											
			1/16 in. 1.590 mm	1/8 in. 3.170 mm	1/4 in. 6.350 mm	3/8 in. 9.520 mm	1/2 in. 12.700 mm	5/8 in. 15.870 mm	3/4 in. 19.050 mm	1 in. 25.400 mm	1 1/4 in. 31.750 mm	1 1/2 in. 38.100 mm		
Common structural steels	≤100 Bhn >100-260 Bhn	•	•	•	•	•	•	•	•	•	•	•	•	•
Free-cutting steels	≤24 Rc >24-30 Rc	•	•	•	•	•	•	•	•	•	•	•	•	•
Unalloyed heat-treatable steels	≤16 Rc 16-24 Rc 24-30 Rc	•	•	•	•	•	•	•	•	•	•	•	•	•
Alloyed heat-treatable steels	24-30 Rc >30-38 Rc	•	•	•	•	•	•	•	•	•	•	•	•	•
Unalloyed case hardened steels	≤230 Bhn	•	•	•	•	•	•	•	•	•	•	•	•	•
Alloyed case hardened steels	24-30 Rc >30-38 Rc	•	•	•	•	•	•	•	•	•	•	•	•	•
Nitriding steels	≥24-30 Rc >30-38 Rc	•	•	•	•	•	•	•	•	•	•	•	•	•
Tool steels	≤24 Rc >24-30 Rc	•	•	•	•	•	•	•	•	•	•	•	•	•
High speed steels	≥14-30 Rc	•	•	•	•	•	•	•	•	•	•	•	•	•
Spring steels	≤330 Bhn	•	•	•	•	•	•	•	•	•	•	•	•	•
Stainless steels, sulphured austenitic martensitic	≤24 Rc ≤24 Rc ≤24 Rc	•	•	•	•	•	•	•	•	•	•	•	•	•
Hardened steels	≤40-48 Rc >48-60 Rc	•	•	•	•	•	•	•	•	•	•	•	•	•
Special alloys	≤38 Rc	295	•	0.0065	0.0100	0.0125	0.0160	0.0180	0.0200	•	•	•	•	•
Cast iron	≤240 Bhn <300 Bhn	260 130	•	0.0065 0.0020	0.0100 0.0030	0.0125 0.0040	0.0160 0.0050	0.0180 0.0055	0.0200 0.0065	•	•	•	•	•
Spheroidal graphite iron and malleable cast iron	≤240 Bhn <300 Bhn	•	•	•	•	•	•	•	•	•	•	•	•	•
Chilled cast iron	≤350 Bhn	•	•	•	•	•	•	•	•	•	•	•	•	•
Ti and Ti-alloys	≤24 Rc >24-38 Rc	•	•	•	•	•	•	•	•	•	•	•	•	•
Aluminium and Al-alloys	≤120 Bhn	1080	•	0.0080	0.0125	0.0160	0.0200	0.0200	0.0220	•	•	•	•	•
Al wrought alloys	≤150 Bhn	•	•	•	•	•	•	•	•	•	•	•	•	•
Al cast alloys ≤ 10 % Si > 10 % Si	≤200 Bhn ≤200 Bhn	• 920	•	• 0.0080	• 0.0125	• 0.0160	• 0.0200	• 0.0200	• 0.0220	•	•	•	•	•
Magnesium alloys	≤150 Bhn	•	•	•	•	•	•	•	•	•	•	•	•	•
Copper, low-alloyed	≤120 Bhn	360	•	0.0050	0.0080	0.0100	0.0125	0.0125	0.0140	•	•	•	•	•
Brass, short-chipping long-chipping	≤200 Bhn ≤200 Bhn	260 •	•	0.0040	0.0065	0.0080	0.0100	0.0100	0.0110	•	•	•	•	•
Bronze, short-chipping	≤200 Bhn >200-260 Bhn	• •	•	•	•	•	•	•	•	•	•	•	•	•
Bronze, long-chipping	≤24 Rc >24-30 Rc	•	•	•	•	•	•	•	•	•	•	•	•	•
Duroplastics	-	•	•	•	•	•	•	•	•	•	•	•	•	•
Thermoplastics	-	•	•	•	•	•	•	•	•	•	•	•	•	•
Reinforced plastics - Kevlar	-	•	•	•	•	•	•	•	•	•	•	•	•	•
Reinforced plastics - GFK / CFK	-	•	•	•	•	•	•	•	•	•	•	•	•	•

Series # 769

Material group	Hardness	SFM	Feed Rate - IPR											
			1/16 in. 1.590 mm	1/8 in. 3.170 mm	1/4 in. 6.350 mm	3/8 in. 9.520 mm	1/2 in. 12.700 mm	5/8 in. 15.870 mm	3/4 in. 19.050 mm	1 in. 25.400 mm	1 1/4 in. 31.750 mm	1 1/2 in. 38.100 mm		
Common structural steels	≤100 Bhn >100-260 Bhn	•	•	•	•	•	•	•	•	•	•	•	•	•
Free-cutting steels	≤24 Rc >24-30 Rc	•	•	•	•	•	•	•	•	•	•	•	•	•
Unalloyed heat-treatable steels	≤16 Rc 16-24 Rc 24-30 Rc	•	•	•	•	•	•	•	•	•	•	•	•	•
Alloyed heat-treatable steels	24-30 Rc >30-38 Rc	•	•	•	•	•	•	•	•	•	•	•	•	•
Unalloyed case hardened steels	≤230 Bhn	•	•	•	•	•	•	•	•	•	•	•	•	•
Alloyed case hardened steels	24-30 Rc >30-38 Rc	•	•	•	•	•	•	•	•	•	•	•	•	•
Nitriding steels	≥24-30 Rc >30-38 Rc	•	•	•	•	•	•	•	•	•	•	•	•	•
Tool steels	≤24 Rc >24-30 Rc	•	•	•	•	•	•	•	•	•	•	•	•	•
High speed steels	≥14-30 Rc	•	•	•	•	•	•	•	•	•	•	•	•	•
Spring steels	≤330 Bhn	•	•	•	•	•	•	•	•	•	•	•	•	•
Stainless steels, sulphured austenitic martensitic	≤24 Rc ≤24 Rc ≤24 Rc	•	•	•	•	•	•	•	•	•	•	•	•	•
Hardened steels	≤40-48 Rc >48-60 Rc	•	•	•	•	•	•	•	•	•	•	•	•	•
Special alloys	≤38 Rc	•	•	•	•	•	•	•	•	•	•	•	•	•
Cast iron	≤240 Bhn <300 Bhn	395 330	•	0.0050 0.0050	0.0080 0.0080	0.0100 0.0100	0.0125 0.0125	0.0125 0.0125	0.0140 0.0140	•	•	•	•	•
Spheroidal graphite iron and malleable cast iron	≤240 Bhn <300 Bhn	295 260	•	0.0050 0.0050	0.0080 0.0080	0.0100 0.0100	0.0125 0.0125	0.0125 0.0125	0.0140 0.0140	•	•	•	•	•
Chilled cast iron	≤350 Bhn	130	•	0.0020	0.0030	0.0040	0.0050	0.0055	0.0065	•	•	•	•	•
Ti and Ti-alloys	≤24 Rc >24-38 Rc	•	•	•	•	•	•	•	•	•	•	•	•	•
Aluminium and Al-alloys	≤120 Bhn	1345	•	0.0080	0.0125	0.0160	0.0200	0.0220	0.0245	•	•	•	•	•
Al wrought alloys	≤150 Bhn	1345	•	0.0080	0.0125	0.0160	0.0200	0.0220	0.0245	•	•	•	•	•
Al cast alloys ≤ 10 % Si > 10 % Si	≤200 Bhn ≤200 Bhn	1245 1080	•	• 0.0080	• 0.0125	• 0.0160	• 0.0200	• 0.0220	• 0.0245	•	•	•	•	•
Magnesium alloys	≤150 Bhn	•	•	•	•	•	•	•	•	•	•	•	•	•
Copper, low-alloyed	≤120 Bhn	•	•	•	•	•	•	•	•	•	•	•	•	•
Brass, short-chipping long-chipping	≤200 Bhn ≤200 Bhn	920 •	•	0.0050	0.0080	0.0100	0.0125	0.0125	0.0140	•	•	•	•	•
Bronze, short-chipping	≤200 Bhn >200-260 Bhn	360 260	•	0.0040 0.0030	0.0065 0.0050	0.0080 0.0065	0.0100 0.0080	0.0100 0.0080	0.0110 0.0090	•	•	•	•	•
Bronze, long-chipping	≤24 Rc >24-30 Rc	•	•	•	•	•	•	•	•	•	•	•	•	•
Duroplastics	-	•	•	•	•	•	•	•	•	•	•	•	•	•
Thermoplastics	-	•	•	•	•	•	•	•	•	•	•	•	•	•
Reinforced plastics - Kevlar	-	•	•	•	•	•	•	•	•	•	•	•	•	•
Reinforced plastics - GFK / CFK	-	•	•	•	•	•	•	•	•	•	•	•	•	•

Using These Tables. The Speeds & Feeds listed below are conservative recommendations for initial setup. In actual use, depending on the machining environment and workpiece material, significantly higher speeds and feeds may be achievable. Using the below as a starting point, cutting speed/feed can be gradually adjusted upwards until the optimum settings per application are found.
 Questions? Contact us by telephone at (800) 776-6170.

Series # 773

Material group	Hardness	SFM	Feed Rate - IPR									
			1/16 in. 1.590 mm	1/8 in. 3.170 mm	1/4 in. 6.350 mm	3/8 in. 9.520 mm	1/2 in. 12.700 mm	5/8 in. 15.870 mm	3/4 in. 19.050 mm	1 in. 25.400 mm	1 1/4 in. 31.750 mm	1 1/2 in. 38.100 mm
Common structural steels	≤100 Bhn >100-260 Bhn	• •	• •	• •	• •	• •	• •	• •	• •	• •	• •	• •
Free-cutting steels	≤24 Rc >24-30 Rc	• •	• •	• •	• •	• •	• •	• •	• •	• •	• •	• •
Unalloyed heat-treatable steels	≤16 Rc 16-24 Rc 24-30 Rc	• • •	• • •	• • •	• • •	• • •	• • •	• • •	• • •	• • •	• • •	• • •
Alloyed heat-treatable steels	24-30 Rc >30-38 Rc	• •	• •	• •	• •	• •	• •	• •	• •	• •	• •	• •
Unalloyed case hardened steels	≤230 Bhn	•	•	•	•	•	•	•	•	•	•	•
Alloyed case hardened steels	24-30 Rc >30-38 Rc	• •	• •	• •	• •	• •	• •	• •	• •	• •	• •	• •
Nitriding steels	≥24-30 Rc >30-38 Rc	• •	• •	• •	• •	• •	• •	• •	• •	• •	• •	• •
Tool steels	≤24 Rc >24-30 Rc	• •	• •	• •	• •	• •	• •	• •	• •	• •	• •	• •
High speed steels	≥14-30 Rc	•	•	•	•	•	•	•	•	•	•	•
Spring steels	≤330 Bhn	•	•	•	•	•	•	•	•	•	•	•
Stainless steels, sulphured austenitic martensitic	≤24 Rc • • •	• • • •	• • • •	• • • •	• • • •	• • • •	• • • •	• • • •	• • • •	• • • •	• • • •	• • • •
Hardened steels	≤40-48 Rc >48-60 Rc	• •	• •	• •	• •	• •	• •	• •	• •	• •	• •	• •
Special alloys	≤38 Rc	•	•	•	•	•	•	•	•	•	•	•
Cast iron	≤240 Bhn <300 Bhn	395 330	• •	0.0030 0.0030	0.0050 0.0050	0.0070 0.0070	0.0080 0.0080	0.0100 0.0100	0.0125 0.0125	• •	• •	• •
Spheroidal graphite iron and malleable cast iron	≤240 Bhn <300 Bhn	295 260	• •	0.0030 0.0030	0.0050 0.0050	0.0070 0.0070	0.0080 0.0080	0.0100 0.0100	0.0125 0.0125	• •	• •	• •
Chilled cast iron	≤350 Bhn	130	•	0.0013	0.0020	0.0025	0.0030	0.0040	0.0050	•	•	•
Ti and Ti-alloys	≤24 Rc >24-38 Rc	• •	• •	• •	• •	• •	• •	• •	• •	• •	• •	• •
Aluminium and Al-alloys	≤120 Bhn	1345	•	0.0050	0.0080	0.0120	0.0125	0.0160	0.0200	•	•	•
Al wrought alloys	≤150 Bhn	1345	•	0.0050	0.0080	0.0120	0.0125	0.0160	0.0200	•	•	•
Al cast alloys ≤ 10 % Si > 10 % Si	≤200 Bhn • •	1245 • 1080	• • •	0.0050 • 0.0050	0.0080 • 0.0080	0.0120 • 0.0120	0.0125 • 0.0125	0.0160 • 0.0160	0.0200 • 0.0200	• • •	• • •	• • •
Magnesium alloys	≤150 Bhn	•	•	•	•	•	•	•	•	•	•	•
Copper, low-alloyed	≤120 Bhn	•	•	•	•	•	•	•	•	•	•	•
Brass, short-chipping long-chipping	≤200 Bhn • •	920 • •	• • •	0.0040 • •	0.0060 • •	0.0090 • •	0.0100 • •	0.0125 • •	0.0160 • •	• • •	• • •	• • •
Bronze, short-chipping	≤200 Bhn >200-260 Bhn	360 260	• •	0.0030 0.0025	0.0050 0.0040	0.0070 0.0050	0.0080 0.0060	0.0100 0.0080	0.0125 0.0100	• •	• •	• •
Bronze, long-chipping	≤24 Rc >24-30 Rc	• •	• •	• •	• •	• •	• •	• •	• •	• •	• •	• •
Duroplastics	-	•	•	•	•	•	•	•	•	•	•	•
Thermoplastics	-	•	•	•	•	•	•	•	•	•	•	•
Reinforced plastics - Kevlar	-	•	•	•	•	•	•	•	•	•	•	•
Reinforced plastics - GFK / CFK	-	•	•	•	•	•	•	•	•	•	•	•

Series # 1047 / # 5242 (3xD body)

Material group	Hardness	SFM	Feed Rate - IPR					
			≤16.000 mm	41/64 - 25/32 in. 16.001 - 20.000 mm	51/64 - 31/32 in. 20.001 - 25.000 mm	63/64 - 1 17/64 in. 25.001 - 31.500 mm	1 1/4 - 1 9/16 in. 31.501 - 40.000 mm	1 37/64 - 1 61/64 in. 40.001 - 50.000 mm
Common structural steels	≤100 Bhn >100-260 Bhn	330 280	0.0100 0.0080	0.0125 0.0100	0.0160 0.0125	0.0160 0.0125	0.0200 0.0160	0.0250 0.0200
Free-cutting steels	≤24 Rc >24-30 Rc	330 280	0.0125 0.0100	0.0160 0.0125	0.0200 0.0160	0.0200 0.0160	0.0250 0.0200	0.0315 0.0250
Unalloyed heat-treatable steels	≤16 Rc 16-24 Rc 24-30 Rc	330 315 280	0.0100 0.0100 0.0080	0.0125 0.0125 0.0100	0.0160 0.0160 0.0125	0.0160 0.0160 0.0125	0.0200 0.0200 0.0160	0.0250 0.0250 0.0200
Alloyed heat-treatable steels	24-30 Rc >30-38 Rc	280 230	0.0100 0.0080	0.0125 0.0100	0.0160 0.0125	0.0160 0.0125	0.0200 0.0160	0.0250 0.0200
Unalloyed case hardened steels	≤230 Bhn	330	0.0125	0.0160	0.0200	0.0200	0.0250	0.0315
Alloyed case hardened steels	24-30 Rc >30-38 Rc	280 185	0.0100 0.0065	0.0125 0.0080	0.0160 0.0100	0.0160 0.0100	0.0200 0.0125	0.0250 0.0160
Nitriding steels	≥24-30 Rc >30-38 Rc	265 185	0.0080 0.0065	0.0100 0.0080	0.0125 0.0100	0.0125 0.0100	0.0160 0.0125	0.0200 0.0160
Tool steels	≤24 Rc >24-30 Rc	135 115	0.0080 0.0065	0.0100 0.0080	0.0125 0.0100	0.0125 0.0100	0.0160 0.0125	0.0200 0.0160
High speed steels	≥14-30 Rc	135	0.0050	0.0065	0.0080	0.0080	0.0100	0.0125
Spring steels	≤330 Bhn	115	0.0040	0.0050	0.0065	0.0065	0.0080	0.0100
Stainless steels, sulphured austenitic martensitic	≤24 Rc • • •	135 • 100 85	0.0050 • 0.0050 0.0050	0.0065 • 0.0065 0.0065	0.0080 • 0.0080 0.0080	0.0080 • 0.0080 0.0080	0.0100 • 0.0100 0.0100	0.0125 • 0.0125 0.0125
Hardened steels	≤40-48 Rc >48-60 Rc	70 •	0.0040 •	0.0050 •	0.0065 •	0.0065 •	0.0080 •	0.0100 •
Special alloys	≤38 Rc	70	0.0040	0.0050	0.0065	0.0065	0.0080	0.0100
Cast iron	≤240 Bhn <300 Bhn	520 390	0.0125 0.0125	0.0160 0.0160	0.0200 0.0200	0.0200 0.0200	0.0250 0.0250	0.0315 0.0315
Spheroidal graphite iron and malleable cast iron	≤240 Bhn <300 Bhn	390 325	0.0125 0.0100	0.0160 0.0125	0.0200 0.0160	0.0200 0.0160	0.0250 0.0200	0.0315 0.0250
Chilled cast iron	≤350 Bhn	85	0.0040	0.0050	0.0065	0.0065	0.0080	0.0100
Ti and Ti-alloys	≤24 Rc >24-38 Rc	100 85	0.0050 0.0040	0.0065 0.0050	0.0080 0.0065	0.0080 0.0065	0.0100 0.0080	0.0125 0.0100
Aluminium and Al-alloys	≤120 Bhn	725	0.0125	0.0160	0.0200	0.0200	0.0250	0.0315
Al wrought alloys	≤150 Bhn	660	0.0125	0.0160	0.0200	0.0200	0.0250	0.0315
Al cast alloys ≤ 10 % Si > 10 % Si	≤200 Bhn • •	590 • 490	0.0125 • 0.0125	0.0160 • 0.0160	0.0200 • 0.0200	0.0200 • 0.0200	0.0250 • 0.0250	0.0315 • 0.0315
Magnesium alloys	≤150 Bhn	655	0.0125	0.0160	0.0200	0.0200	0.0250	0.0315
Copper, low-alloyed	≤120 Bhn	260	0.0100	0.0125	0.0160	0.0160	0.0200	0.0250
Brass, short-chipping long-chipping	≤200 Bhn • •	685 • 455	0.0125 • 0.0100	0.0160 • 0.0125	0.0200 • 0.0160	0.0200 • 0.0160	0.0250 • 0.0200	0.0315 • 0.0250
Bronze, short-chipping	≤200 Bhn >200-260 Bhn	260 210	0.0100 0.0100	0.0125 0.0125	0.0160 0.0160	0.0160 0.0160	0.0200 0.0200	0.0250 0.0250
Bronze, long-chipping	≤24 Rc >24-30 Rc	160 130	0.0100 0.0080	0.0125 0.0100	0.0160 0.0125	0.0160 0.0125	0.0200 0.0160	0.0250 0.0200
Duroplastics	-	260	0.0080	0.0100	0.0125	0.0125	0.0160	0.0200
Thermoplastics	-	260	0.0080	0.0100	0.0125	0.0125	0.0160	0.0200
Reinforced plastics - Kevlar	-	260	0.0080	0.0100	0.0125	0.0125	0.0160	0.0200
Reinforced plastics - GFK / CFK	-	260	0.0080	0.0100	0.0125	0.0125	0.0160	0.0200

$$\text{RPM} = \frac{\text{SFM}}{\text{DIAM. in.}} \times 3.82 \quad \text{IPM} = \text{IPR} \times \text{RPM}$$

$$\frac{\text{HOLE DEPTH in.}}{\text{IPM}} \times 60 = \text{Cut Time}$$

$$\text{mm} = \text{in.} \times 25.40$$

$$\text{m/min.} = \text{SFM} \div 3.28$$

$$\text{mm/rev.} = \text{IPR} \div 25.40$$

$$\text{Bar} = \text{PSI} \div 14.50$$

$$\text{Liter} = \text{Gal.} \div 3.79$$

Series # 1047 / # 5243 (5xD body)

Material group	Hardness	SFM	Feed Rate - IPR					
			≤16.000 mm	41/64 - 25/32 in. 16.001 - 20.000 mm	51/64 - 31/32 in. 20.001 - 25.000 mm	63/64 - 1 17/64 in. 25.001 - 31.500 mm	1 1/4 - 1 9/16 in. 31.501 - 40.000 mm	1 37/64 - 1 61/64 in. 40.001 - 50.000 mm
Common structural steels	≤100 Bhn	315	0.0100	0.0125	0.0160	0.0200	0.0200	0.0250
	>100-260 Bhn	265	0.0080	0.0100	0.0125	0.0125	0.0160	0.0200
Free-cutting steels	≤24 Rc	315	0.0125	0.0160	0.0200	0.0200	0.0250	0.0315
	>24-30 Rc	265	0.0100	0.0125	0.0160	0.0160	0.0200	0.0250
Unalloyed heat-treatable steels	≤16 Rc	315	0.0100	0.0125	0.0160	0.0160	0.0200	0.0250
	16-24 Rc	300	0.0100	0.0125	0.0160	0.0160	0.0200	0.0250
	24-30 Rc	265	0.0080	0.0100	0.0125	0.0125	0.0160	0.0200
Alloyed heat-treatable steels	24-30 Rc	265	0.0100	0.0125	0.0160	0.0160	0.0200	0.0250
	>30-38 Rc	215	0.0080	0.0100	0.0125	0.0125	0.0160	0.0200
Unalloyed case hardened steels	≤230 Bhn	315	0.0125	0.0160	0.0200	0.0200	0.0250	0.0315
Alloyed case hardened steels	24-30 Rc	265	0.0100	0.0125	0.0160	0.0160	0.0200	0.0250
	>30-38 Rc	185	0.0065	0.0080	0.0100	0.0100	0.0125	0.0160
Nitriding steels	≥24-30 Rc	265	0.0080	0.0100	0.0125	0.0125	0.0160	0.0200
	>30-38 Rc	185	0.0065	0.0080	0.0100	0.0100	0.0125	0.0160
Tool steels	≤24 Rc	135	0.0080	0.0100	0.0125	0.0125	0.0160	0.0200
	>24-30 Rc	115	0.0065	0.0080	0.0100	0.0100	0.0125	0.0160
High speed steels	≥14-30 Rc	135	0.0050	0.0065	0.0080	0.0080	0.0100	0.0125
Spring steels	≤330 Bhn	115	0.0040	0.0050	0.0065	0.0065	0.0080	0.0100
Stainless steels, sulphured austenitic martensitic	≤24 Rc	135	0.0050	0.0065	0.0080	0.0080	0.0100	0.0125
	≤24 Rc	100	0.0050	0.0065	0.0080	0.0080	0.0100	0.0125
	≤24 Rc	85	0.0050	0.0065	0.0080	0.0080	0.0100	0.0125
Hardened steels	≤40-48 Rc	70	0.0040	0.0050	0.0065	0.0065	0.0080	0.0100
	>48-60 Rc	*	*	*	*	*	*	*
Special alloys	≤38 Rc	70	0.0040	0.0050	0.0065	0.0065	0.0080	0.0100
Cast iron	≤240 Bhn	490	0.0125	0.0160	0.0200	0.0200	0.0250	0.0315
	<300 Bhn	360	0.0125	0.0160	0.0200	0.0200	0.0250	0.0315
Spheroidal graphite iron and malleable cast iron	≤240 Bhn	360	0.0125	0.0160	0.0200	0.0200	0.0250	0.0315
	<300 Bhn	295	0.0100	0.0125	0.0160	0.0160	0.0200	0.0250
Chilled cast iron	≤350 Bhn	85	0.0040	0.0050	0.0065	0.0065	0.0080	0.0100
Ti and Ti-alloys	≤24 Rc	100	0.0050	0.0065	0.0080	0.0080	0.0100	0.0125
	>24-38 Rc	85	0.0040	0.0050	0.0065	0.0065	0.0080	0.0100
Aluminium and Al-alloys	≤120 Bhn	660	0.0125	0.0160	0.0200	0.0200	0.0250	0.0315
Al wrought alloys	≤150 Bhn	660	0.0125	0.0160	0.0200	0.0200	0.0250	0.0315
Al cast alloys ≤ 10 % Si	≤200 Bhn	555	0.0125	0.0160	0.0200	0.0200	0.0250	0.0315
	> 10 % Si	455	0.0125	0.0160	0.0200	0.0200	0.0250	0.0315
Magnesium alloys	≤150 Bhn	655	0.0125	0.0160	0.0200	0.0200	0.0250	0.0315
Copper, low-alloyed	≤120 Bhn	260	0.0100	0.0125	0.0160	0.0160	0.0200	0.0250
Brass, short-chipping long-chipping	≤200 Bhn	685	0.0125	0.0160	0.0200	0.0200	0.0250	0.0315
	≤200 Bhn	455	0.0100	0.0125	0.0160	0.0160	0.0200	0.0250
Bronze, short-chipping	≤200 Bhn	260	0.0100	0.0125	0.0160	0.0160	0.0200	0.0250
	>200-260 Bhn	210	0.0100	0.0125	0.0160	0.0160	0.0200	0.0250
Bronze, long-chipping	≤24 Rc	160	0.0100	0.0125	0.0160	0.0160	0.0200	0.0250
	>24-30 Rc	130	0.0080	0.0100	0.0125	0.0125	0.0160	0.0200
Duroplastics	-	260	0.0080	0.0100	0.0125	0.0125	0.0160	0.0200
Thermoplastics	-	260	0.0080	0.0100	0.0125	0.0125	0.0160	0.0200
Reinforced plastics - Kevlar	-	260	0.0080	0.0100	0.0125	0.0125	0.0160	0.0200
Reinforced plastics - GFK / CFK	-	260	0.0080	0.0100	0.0125	0.0125	0.0160	0.0200

Series # 1047 / # 5248 (7xD body)

Material group	Hardness	SFM	Feed Rate - IPR					
			≤16.000 mm	41/64 - 25/32 in. 16.001 - 20.000 mm	51/64 - 31/32 in. 20.001 - 25.000 mm	63/64 - 1 17/64 in. 25.001 - 31.500 mm	1 1/4 - 1 9/16 in. 31.501 - 40.000 mm	1 37/64 - 1 61/64 in. 40.001 - 50.000 mm
Common structural steels	≤100 Bhn	300	0.0080	0.0100	0.0125	0.0125	0.0160	0.0200
	>100-260 Bhn	265	0.0065	0.0080	0.0100	0.0100	0.0125	0.0160
Free-cutting steels	≤24 Rc	300	0.0100	0.0125	0.0160	0.0160	0.0200	0.0250
	>24-30 Rc	265	0.0080	0.0100	0.0125	0.0125	0.0160	0.0200
Unalloyed heat-treatable steels	≤16 Rc	300	0.0080	0.0100	0.0125	0.0125	0.0160	0.0200
	16-24 Rc	280	0.0080	0.0100	0.0125	0.0125	0.0160	0.0200
	24-30 Rc	250	0.0065	0.0080	0.0100	0.0100	0.0125	0.0160
Alloyed heat-treatable steels	24-30 Rc	250	0.0080	0.0100	0.0125	0.0125	0.0160	0.0200
	>30-38 Rc	215	0.0065	0.0080	0.0100	0.0100	0.0125	0.0160
Unalloyed case hardened steels	≤230 Bhn	300	0.0100	0.0125	0.0160	0.0160	0.0200	0.0250
Alloyed case hardened steels	24-30 Rc	250	0.0080	0.0100	0.0125	0.0125	0.0160	0.0200
	>30-38 Rc	185	0.0065	0.0080	0.0100	0.0100	0.0125	0.0160
Nitriding steels	≥24-30 Rc	265	0.0065	0.0080	0.0100	0.0100	0.0125	0.0160
	>30-38 Rc	185	0.0050	0.0065	0.0080	0.0080	0.0100	0.0125
Tool steels	≤24 Rc	135	0.0065	0.0080	0.0100	0.0100	0.0125	0.0160
	>24-30 Rc	115	0.0050	0.0065	0.0080	0.0080	0.0100	0.0125
High speed steels	≥14-30 Rc	135	0.0040	0.0050	0.0065	0.0065	0.0080	0.0100
Spring steels	≤330 Bhn	115	0.0040	0.0050	0.0065	0.0065	0.0080	0.0100
Stainless steels, sulphured austenitic martensitic	≤24 Rc	135	0.0040	0.0050	0.0065	0.0065	0.0080	0.0100
	≤24 Rc	100	0.0040	0.0050	0.0065	0.0065	0.0080	0.0100
	≤24 Rc	85	0.0040	0.0050	0.0065	0.0065	0.0080	0.0100
Hardened steels	≤40-48 Rc	70	0.0035	0.0040	0.0050	0.0065	0.0065	0.0080
	>48-60 Rc	*	*	*	*	*	*	*
Special alloys	≤38 Rc	70	0.0035	0.0040	0.0050	0.0065	0.0065	0.0080
Cast iron	≤240 Bhn	490	0.0100	0.0125	0.0160	0.0160	0.0200	0.0250
	<300 Bhn	360	0.0100	0.0125	0.0160	0.0160	0.0200	0.0250
Spheroidal graphite iron and malleable cast iron	≤240 Bhn	360	0.0100	0.0125	0.0160	0.0160	0.0200	0.0250
	<300 Bhn	295	0.0080	0.0100	0.0125	0.0125	0.0160	0.0200
Chilled cast iron	≤350 Bhn	85	0.0040	0.0050	0.0065	0.0065	0.0080	0.0100
Ti and Ti-alloys	≤24 Rc	100	0.0040	0.0050	0.0065	0.0065	0.0080	0.0100
	>24-38 Rc	85	0.0035	0.0040	0.0050	0.0065	0.0065	0.0080
Aluminium and Al-alloys	≤120 Bhn	660	0.0100	0.0125	0.0160	0.0160	0.0200	0.0250
Al wrought alloys	≤150 Bhn	660	0.0100	0.0125	0.0160	0.0160	0.0200	0.0250
Al cast alloys ≤ 10 % Si	≤200 Bhn	555	0.0100	0.0125	0.0160	0.0160	0.0200	0.0250
	> 10 % Si	455	0.0100	0.0125	0.0160	0.0160	0.0200	0.0250
Magnesium alloys	≤150 Bhn	655	0.0100	0.0125	0.0160	0.0160	0.0200	0.0250
Copper, low-alloyed	≤120 Bhn	260	0.0080	0.0100	0.0125	0.0125	0.0160	0.0200
Brass, short-chipping long-chipping	≤200 Bhn	685	0.0100	0.0125	0.0160	0.0160	0.0200	0.0250
	≤200 Bhn	455	0.0080	0.0100	0.0125	0.0125	0.0160	0.0200
Bronze, short-chipping	≤200 Bhn	260	0.0080	0.0100	0.0125	0.0125	0.0160	0.0200
	>200-260 Bhn	210	0.0080	0.0100	0.0125	0.0125	0.0160	0.0200
Bronze, long-chipping	≤24 Rc	160	0.0080	0.0100	0.0125	0.0125	0.0160	0.0200
	>24-30 Rc	130	0.0065	0.0080	0.0100	0.0100	0.0125	0.0160
Duroplastics	-	260	0.0065	0.0080	0.0100	0.0100	0.0125	0.0160
Thermoplastics	-	260	0.0065	0.0080	0.0100	0.0100	0.0125	0.0160
Reinforced plastics - Kevlar	-	260	0.0065	0.0080	0.0100	0.0100	0.0125	0.0160
Reinforced plastics - GFK / CFK	-	260	0.0065	0.0080	0.0100	0.0100	0.0125	0.0160

Series # 1131

Material group	Hardness	SFM	Feed Rate - IPR										
			1/16 in. 1.590 mm	1/8 in. 3.170 mm	1/4 in. 6.350 mm	3/8 in. 9.520 mm	1/2 in. 12.700 mm	5/8 in. 15.870 mm	3/4 in. 19.050 mm	1 in. 25.400 mm	1 1/4 in. 31.750 mm	1 1/2 in. 38.100 mm	
Common structural steels	≤100 Bhn >100-260 Bhn	155 120	•	•	•	•	•	•	•	•	•	•	•
Free-cutting steels	≤24 Rc >24-30 Rc	155 120	•	•	•	•	•	•	•	•	•	•	•
Unalloyed heat-treatable steels	≤16 Rc 16-24 Rc 24-30 Rc	155 120 65	•	•	•	•	•	•	•	•	•	•	•
Alloyed heat-treatable steels	24-30 Rc >30-38 Rc	80 65	•	•	•	•	•	•	•	•	•	•	•
Unalloyed case hardened steels	≤230 Bhn	160	•	•	•	•	•	•	•	•	•	•	•
Alloyed case hardened steels	24-30 Rc >30-38 Rc	70 50	•	•	•	•	•	•	•	•	•	•	•
Nitriding steels	≥24-30 Rc >30-38 Rc	65 45	•	•	•	•	•	•	•	•	•	•	•
Tool steels	≤24 Rc >24-30 Rc	75 45	•	•	•	•	•	•	•	•	•	•	•
High speed steels	≥14-30 Rc	45	•	•	•	•	•	•	•	•	•	•	•
Spring steels	≤330 Bhn	35	•	•	•	•	•	•	•	•	•	•	•
Stainless steels, sulphured austenitic martensitic	≤24 Rc 24-30 Rc ≥24 Rc	65 45 50	•	•	•	•	•	•	•	•	•	•	•
Hardened steels	≤40-48 Rc >48-60 Rc	10 •	•	•	•	•	•	•	•	•	•	•	•
Special alloys	≤38 Rc	30	•	•	•	•	•	•	•	•	•	•	•
Cast iron	≤240 Bhn <300 Bhn	155 120	•	•	•	•	•	•	•	•	•	•	•
Spheroidal graphite iron and malleable cast iron	≤240 Bhn <300 Bhn	135 95	•	•	•	•	•	•	•	•	•	•	•
Chilled cast iron	≤350 Bhn	35	•	•	•	•	•	•	•	•	•	•	•
Ti and Ti-alloys	≤24 Rc >24-38 Rc	45 30	•	•	•	•	•	•	•	•	•	•	•
Aluminium and Al-alloys	≤120 Bhn	•	•	•	•	•	•	•	•	•	•	•	•
Al wrought alloys	≤150 Bhn	•	•	•	•	•	•	•	•	•	•	•	•
Al cast alloys ≤ 10 % Si > 10 % Si	≤200 Bhn ≤200 Bhn	310 245	•	•	•	•	•	•	•	•	•	•	•
Magnesium alloys	≤150 Bhn	•	•	•	•	•	•	•	•	•	•	•	•
Copper, low-alloyed	≤120 Bhn	155	•	•	•	•	•	•	•	•	•	•	•
Brass, short-chipping long-chipping	≤200 Bhn ≤200 Bhn	• 195	•	•	•	•	•	•	•	•	•	•	•
Bronze, short-chipping	≤200 Bhn >200-260 Bhn	• 135	•	•	•	•	•	•	•	•	•	•	•
Bronze, long-chipping	≤24 Rc >24-30 Rc	120 95	•	•	•	•	•	•	•	•	•	•	•
Duroplastics Thermoplastics	- -	• 120	•	•	•	•	•	•	•	•	•	•	•
Reinforced plastics - Kevlar Reinforced plastics - GFK / CFK	- -	• •	•	•	•	•	•	•	•	•	•	•	•

Series # 1132

Material group	Hardness	SFM	Feed Rate - IPR										
			1/16 in. 1.590 mm	1/8 in. 3.170 mm	1/4 in. 6.350 mm	3/8 in. 9.520 mm	1/2 in. 12.700 mm	5/8 in. 15.870 mm	3/4 in. 19.050 mm	1 in. 25.400 mm	1 1/4 in. 31.750 mm	1 1/2 in. 38.100 mm	
Common structural steels	≤100 Bhn >100-260 Bhn	195 155	•	•	•	•	•	•	•	•	•	•	•
Free-cutting steels	≤24 Rc >24-30 Rc	195 155	•	•	•	•	•	•	•	•	•	•	•
Unalloyed heat-treatable steels	≤16 Rc 16-24 Rc 24-30 Rc	195 155 80	•	•	•	•	•	•	•	•	•	•	•
Alloyed heat-treatable steels	24-30 Rc >30-38 Rc	95 80	•	•	•	•	•	•	•	•	•	•	•
Unalloyed case hardened steels	≤230 Bhn	200	•	•	•	•	•	•	•	•	•	•	•
Alloyed case hardened steels	24-30 Rc >30-38 Rc	90 65	•	•	•	•	•	•	•	•	•	•	•
Nitriding steels	≥24-30 Rc >30-38 Rc	80 55	•	•	•	•	•	•	•	•	•	•	•
Tool steels	≤24 Rc >24-30 Rc	95 55	•	•	•	•	•	•	•	•	•	•	•
High speed steels	≥14-30 Rc	55	•	•	•	•	•	•	•	•	•	•	•
Spring steels	≤330 Bhn	45	•	•	•	•	•	•	•	•	•	•	•
Stainless steels, sulphured austenitic martensitic	≤24 Rc 24-30 Rc ≥24 Rc	80 55 65	•	•	•	•	•	•	•	•	•	•	•
Hardened steels	≤40-48 Rc >48-60 Rc	15 45	•	•	•	•	•	•	•	•	•	•	•
Special alloys	≤38 Rc	35	•	•	•	•	•	•	•	•	•	•	•
Cast iron	≤240 Bhn <300 Bhn	195 155	•	•	•	•	•	•	•	•	•	•	•
Spheroidal graphite iron and malleable cast iron	≤240 Bhn <300 Bhn	170 120	•	•	•	•	•	•	•	•	•	•	•
Chilled cast iron	≤350 Bhn	45	•	•	•	•	•	•	•	•	•	•	•
Ti and Ti-alloys	≤24 Rc >24-38 Rc	55 35	•	•	•	•	•	•	•	•	•	•	•
Aluminium and Al-alloys	≤120 Bhn	•	•	•	•	•	•	•	•	•	•	•	•
Al wrought alloys	≤150 Bhn	•	•	•	•	•	•	•	•	•	•	•	•
Al cast alloys ≤ 10 % Si > 10 % Si	≤200 Bhn ≤200 Bhn	390 310	•	•	•	•	•	•	•	•	•	•	•
Magnesium alloys	≤150 Bhn	•	•	•	•	•	•	•	•	•	•	•	•
Copper, low-alloyed	≤120 Bhn	195	•	•	•	•	•	•	•	•	•	•	•
Brass, short-chipping long-chipping	≤200 Bhn ≤200 Bhn	• 245	•	•	•	•	•	•	•	•	•	•	•
Bronze, short-chipping	≤200 Bhn >200-260 Bhn	• 170	•	•	•	•	•	•	•	•	•	•	•
Bronze, long-chipping	≤24 Rc >24-30 Rc	155 120	•	•	•	•	•	•	•	•	•	•	•
Duroplastics Thermoplastics	- -	• 155	•	•	•	•	•	•	•	•	•	•	•
Reinforced plastics - Kevlar Reinforced plastics - GFK / CFK	- -	• •	•	•	•	•	•	•	•	•	•	•	•

$$\text{RPM} = \frac{\text{SFM}}{\text{DIAM. in.}} \times 3.82 \quad \text{IPM} = \text{IPR} \times \text{RPM}$$

$$\frac{\text{HOLE DEPTH in.}}{\text{IPM}} \times 60 = \text{Cut Time}$$

$$\text{mm} = \text{in.} \times 25.40$$

$$\text{m/min.} = \text{SFM} \div 3.28$$

$$\text{mm/rev.} = \text{IPR} \div 25.40$$

$$\text{Bar} = \text{PSI} \div 14.50$$

$$\text{Liter} = \text{Gal.} \div 3.79$$

Series # 1183

Material group	Hardness	SFM	Feed Rate - IPR										
			1/16 in. 1.590 mm	1/8 in. 3.170 mm	1/4 in. 6.350 mm	3/8 in. 9.520 mm	1/2 in. 12.700 mm	5/8 in. 15.870 mm	3/4 in. 19.050 mm	1 in. 25.400 mm	1 1/4 in. 31.750 mm	1 1/2 in. 38.100 mm	
Common structural steels	≤100 Bhn >100-260 Bhn	360 295	•	0.0050	0.0080	0.0100	0.0125	0.0125	0.0100	0.0140	•	•	•
Free-cutting steels	≤24 Rc >24-30 Rc	425 360	•	0.0065	0.0100	0.0125	0.0160	0.0160	0.0180	0.0180	•	•	•
Unalloyed heat-treatable steels	≤16 Rc 16-24 Rc 24-30 Rc	325 310 295	•	0.0065	0.0100	0.0080	0.0125	0.0160	0.0160	0.0180	•	•	•
Alloyed heat-treatable steels	24-30 Rc >30-38 Rc	295 260	•	0.0050	0.0080	0.0100	0.0125	0.0125	0.0140	0.0140	•	•	•
Unalloyed case hardened steels	≤230 Bhn	360	•	0.0065	0.0100	0.0125	0.0160	0.0160	0.0180	•	•	•	
Alloyed case hardened steels	24-30 Rc >30-38 Rc	295 210	•	0.0050	0.0080	0.0100	0.0125	0.0125	0.0140	0.0140	•	•	•
Nitriding steels	≥24-30 Rc >30-38 Rc	260 245	•	0.0050	0.0080	0.0100	0.0125	0.0125	0.0140	0.0140	•	•	•
Tool steels	≤24 Rc >24-30 Rc	180 130	•	0.0040	0.0065	0.0080	0.0100	0.0100	0.0110	0.0110	•	•	•
High speed steels	≥14-30 Rc	145	•	0.0025	0.0040	0.0050	0.0065	0.0065	0.0070	•	•	•	
Spring steels	≤330 Bhn	145	•	0.0020	0.0030	0.0040	0.0050	0.0050	0.0055	•	•	•	
Stainless steels, sulphured austenitic martensitic	≤24 Rc ≤24 Rc ≤24 Rc	145 130 110	•	0.0030	0.0050	0.0065	0.0080	0.0080	0.0090	0.0090	•	•	•
Hardened steels	≤40-48 Rc >48-60 Rc	• •	•	•	•	•	•	•	•	•	•	•	•
Special alloys	≤38 Rc	•	•	•	•	•	•	•	•	•	•	•	•
Cast iron	≤240 Bhn <300 Bhn	620 360	•	0.0080	0.0125	0.0160	0.0200	0.0200	0.0220	0.0220	•	•	•
Spheroidal graphite iron and malleable cast iron	≤240 Bhn <300 Bhn	360 310	•	0.0080	0.0125	0.0160	0.0200	0.0200	0.0220	0.0220	•	•	•
Chilled cast iron	≤350 Bhn	•	•	•	•	•	•	•	•	•	•	•	•
Ti and Ti-alloys	≤24 Rc >24-38 Rc	• •	•	•	•	•	•	•	•	•	•	•	•
Aluminium and Al-alloys	≤120 Bhn	785	•	0.0080	0.0125	0.0160	0.0200	0.0200	0.0220	0.0220	•	•	•
Al wrought alloys	≤150 Bhn	785	•	0.0080	0.0125	0.0160	0.0200	0.0200	0.0220	0.0220	•	•	•
Al cast alloys ≤ 10 % Si > 10 % Si	≤200 Bhn ≤200 Bhn	655 555	•	0.0080	0.0125	0.0160	0.0200	0.0200	0.0220	0.0220	•	•	•
Magnesium alloys	≤150 Bhn	•	•	•	•	•	•	•	•	•	•	•	•
Copper, low-alloyed	≤120 Bhn	•	•	•	•	•	•	•	•	•	•	•	•
Brass, short-chipping long-chipping	≤200 Bhn ≤200 Bhn	• •	•	•	•	•	•	•	•	•	•	•	•
Bronze, short-chipping	≤200 Bhn >200-260 Bhn	• •	•	•	•	•	•	•	•	•	•	•	•
Bronze, long-chipping	≤24 Rc >24-30 Rc	• •	•	•	•	•	•	•	•	•	•	•	•
Duroplastics	-	•	•	•	•	•	•	•	•	•	•	•	•
Thermoplastics	-	•	•	•	•	•	•	•	•	•	•	•	•
Reinforced plastics - Kevlar	-	•	•	•	•	•	•	•	•	•	•	•	•
Reinforced plastics - GFK / CFK	-	•	•	•	•	•	•	•	•	•	•	•	•

Series # 1184

Material group	Hardness	SFM	Feed Rate - IPR										
			1/16 in. 1.590 mm	1/8 in. 3.170 mm	1/4 in. 6.350 mm	3/8 in. 9.520 mm	1/2 in. 12.700 mm	5/8 in. 15.870 mm	3/4 in. 19.050 mm	1 in. 25.400 mm	1 1/4 in. 31.750 mm	1 1/2 in. 38.100 mm	
Common structural steels	≤100 Bhn >100-260 Bhn	330 280	•	0.0050	0.0080	0.0100	0.0125	0.0140	0.0160	0.0160	•	•	•
Free-cutting steels	≤24 Rc >24-30 Rc	360 280	•	0.0065	0.0100	0.0125	0.0160	0.0180	0.0200	0.0200	•	•	•
Unalloyed heat-treatable steels	≤16 Rc 16-24 Rc 24-30 Rc	260 280 260	•	0.0050	0.0080	0.0100	0.0125	0.0140	0.0160	0.0160	•	•	•
Alloyed heat-treatable steels	24-30 Rc >30-38 Rc	260 245	•	0.0050	0.0080	0.0100	0.0125	0.0140	0.0160	0.0160	•	•	•
Unalloyed case hardened steels	≤230 Bhn	330	•	0.0065	0.0100	0.0125	0.0160	0.0180	0.0200	•	•	•	
Alloyed case hardened steels	24-30 Rc >30-38 Rc	295 215	•	0.0050	0.0080	0.0100	0.0125	0.0140	0.0160	0.0160	•	•	•
Nitriding steels	≥24-30 Rc >30-38 Rc	245 230	•	0.0040	0.0065	0.0080	0.0100	0.0110	0.0125	0.0125	•	•	•
Tool steels	≤24 Rc >24-30 Rc	165 130	•	0.0050	0.0080	0.0100	0.0125	0.0140	0.0160	0.0160	•	•	•
High speed steels	≥14-30 Rc	•	•	•	•	•	•	•	•	•	•	•	•
Spring steels	≤330 Bhn	115	•	0.0020	0.0030	0.0040	0.0050	0.0055	0.0065	•	•	•	•
Stainless steels, sulphured austenitic martensitic	≤24 Rc ≤24 Rc ≤24 Rc	95 90 90	•	0.0025	0.0040	0.0050	0.0065	0.0065	0.0080	0.0080	•	•	•
Hardened steels	≤40-48 Rc >48-60 Rc	• •	•	•	•	•	•	•	•	•	•	•	•
Special alloys	≤38 Rc	•	•	•	•	•	•	•	•	•	•	•	•
Cast iron	≤240 Bhn <300 Bhn	525 395	•	0.0065	0.0100	0.0125	0.0160	0.0180	0.0200	0.0200	•	•	•
Spheroidal graphite iron and malleable cast iron	≤240 Bhn <300 Bhn	395 310	•	0.0050	0.0080	0.0100	0.0125	0.0140	0.0160	0.0160	•	•	•
Chilled cast iron	≤350 Bhn	•	•	•	•	•	•	•	•	•	•	•	•
Ti and Ti-alloys	≤24 Rc >24-38 Rc	• •	•	•	•	•	•	•	•	•	•	•	•
Aluminium and Al-alloys	≤120 Bhn	655	•	0.0080	0.0125	0.0160	0.0200	0.0220	0.0245	0.0245	•	•	•
Al wrought alloys	≤150 Bhn	655	•	0.0080	0.0125	0.0160	0.0200	0.0220	0.0245	0.0245	•	•	•
Al cast alloys ≤ 10 % Si > 10 % Si	≤200 Bhn ≤200 Bhn	560 460	•	0.0080	0.0125	0.0160	0.0200	0.0220	0.0245	0.0245	•	•	•
Magnesium alloys	≤150 Bhn	•	•	•	•	•	•	•	•	•	•	•	•
Copper, low-alloyed	≤120 Bhn	•	•	•	•	•	•	•	•	•	•	•	•
Brass, short-chipping long-chipping	≤200 Bhn ≤200 Bhn	• •	•	•	•	•	•	•	•	•	•	•	•
Bronze, short-chipping	≤200 Bhn >200-260 Bhn	• •	•	•	•	•	•	•	•	•	•	•	•
Bronze, long-chipping	≤24 Rc >24-30 Rc	• •	•	•	•	•	•	•	•	•	•	•	•
Duroplastics	-	•	•	•	•	•	•	•	•	•	•	•	•
Thermoplastics	-	•	•	•	•	•	•	•	•	•	•	•	•
Reinforced plastics - Kevlar	-	•	•	•	•	•	•	•	•	•	•	•	•
Reinforced plastics - GFK / CFK	-	•	•	•	•	•	•	•	•	•	•	•	•

Series # 1221

Material group	Hardness	SFM	Feed Rate - IPR										
			1/16 in. 1.590 mm	1/8 in. 3.170 mm	1/4 in. 6.350 mm	3/8 in. 9.520 mm	1/2 in. 12.700 mm	5/8 in. 15.870 mm	3/4 in. 19.050 mm	1 in. 25.400 mm	1 1/4 in. 31.750 mm	1 1/2 in. 38.100 mm	
Common structural steels	≤100 Bhn	•	•	•	•	•	•	•	•	•	•	•	•
	>100-260 Bhn	•	•	•	•	•	•	•	•	•	•	•	•
Free-cutting steels	≤24 Rc	•	•	•	•	•	•	•	•	•	•	•	•
	>24-30 Rc	130	0.0017	0.0050	0.0080	0.0100	0.0125	•	•	•	•	•	•
Unalloyed heat-treatable steels	≤16 Rc	•	•	•	•	•	•	•	•	•	•	•	•
	16-24 Rc	•	•	•	•	•	•	•	•	•	•	•	•
	24-30 Rc	70	0.0015	0.0040	0.0065	0.0080	0.0100	•	•	•	•	•	•
Alloyed heat-treatable steels	24-30 Rc	85	0.0015	0.0040	0.0065	0.0080	0.0100	•	•	•	•	•	•
	>30-38 Rc	65	0.0012	0.0030	0.0050	0.0065	0.0080	•	•	•	•	•	•
Unalloyed case hardened steels	≤230 Bhn	180	0.0020	0.0065	0.0100	0.0125	0.0160	•	•	•	•	•	•
Alloyed case hardened steels	24-30 Rc	70	0.0015	0.0040	0.0065	0.0080	0.0100	•	•	•	•	•	•
	>30-38 Rc	55	0.0012	0.0030	0.0050	0.0065	0.0080	•	•	•	•	•	•
Nitriding steels	≥24-30 Rc	65	0.0015	0.0040	0.0065	0.0080	0.0100	•	•	•	•	•	•
	>30-38 Rc	45	0.0012	0.0030	0.0050	0.0065	0.0080	•	•	•	•	•	•
Tool steels	≤24 Rc	85	0.0015	0.0040	0.0065	0.0080	0.0100	•	•	•	•	•	•
	>24-30 Rc	45	0.0012	0.0030	0.0050	0.0065	0.0080	•	•	•	•	•	•
High speed steels	≥14-30 Rc	45	0.0012	0.0030	0.0050	0.0065	0.0080	•	•	•	•	•	•
Spring steels	≤330 Bhn	35	0.0010	0.0025	0.0040	0.0050	0.0065	•	•	•	•	•	•
Stainless steels, sulphured austenitic martensitic	≤24 Rc	65	0.0015	0.0040	0.0065	0.0080	0.0100	•	•	•	•	•	•
	≤24 Rc	•	•	•	•	•	•	•	•	•	•	•	•
	≤24 Rc	55	0.0012	0.0030	0.0050	0.0065	0.0080	•	•	•	•	•	•
Hardened steels	≤40-48 Rc	•	•	•	•	•	•	•	•	•	•	•	•
	>48-60 Rc	•	•	•	•	•	•	•	•	•	•	•	•
Special alloys	≤38 Rc	•	•	•	•	•	•	•	•	•	•	•	•
Cast iron	≤240 Bhn	•	•	•	•	•	•	•	•	•	•	•	•
	<300 Bhn	•	•	•	•	•	•	•	•	•	•	•	•
Spheroidal graphite iron and malleable cast iron	≤240 Bhn	•	•	•	•	•	•	•	•	•	•	•	•
	<300 Bhn	•	•	•	•	•	•	•	•	•	•	•	•
Chilled cast iron	≤350 Bhn	•	•	•	•	•	•	•	•	•	•	•	•
Ti and Ti-alloys	≤24 Rc	•	•	•	•	•	•	•	•	•	•	•	•
	>24-38 Rc	•	•	•	•	•	•	•	•	•	•	•	•
Aluminium and Al-alloys	≤120 Bhn	•	•	•	•	•	•	•	•	•	•	•	•
Al wrought alloys	≤150 Bhn	•	•	•	•	•	•	•	•	•	•	•	•
Al cast alloys ≤ 10 % Si	≤200 Bhn	•	•	•	•	•	•	•	•	•	•	•	•
	> 10 % Si	•	•	•	•	•	•	•	•	•	•	•	•
Magnesium alloys	≤150 Bhn	•	•	•	•	•	•	•	•	•	•	•	•
Copper, low-alloyed	≤120 Bhn	•	•	•	•	•	•	•	•	•	•	•	•
Brass, short-chipping	≤200 Bhn	•	•	•	•	•	•	•	•	•	•	•	•
	long-chipping	≤200 Bhn	•	•	•	•	•	•	•	•	•	•	•
Bronze, short-chipping	≤200 Bhn	•	•	•	•	•	•	•	•	•	•	•	•
	>200-260 Bhn	•	•	•	•	•	•	•	•	•	•	•	•
Bronze, long-chipping	≤24 Rc	•	•	•	•	•	•	•	•	•	•	•	•
	>24-30 Rc	•	•	•	•	•	•	•	•	•	•	•	•
Duroplastics	—	•	•	•	•	•	•	•	•	•	•	•	•
Thermoplastics	—	•	•	•	•	•	•	•	•	•	•	•	•
Reinforced plastics - Kevlar	—	•	•	•	•	•	•	•	•	•	•	•	•
Reinforced plastics - GFK / CFK	—	•	•	•	•	•	•	•	•	•	•	•	•

Series # 1223

Material group	Hardness	SFM	Feed Rate - IPR										
			1/16 in. 1.590 mm	1/8 in. 3.170 mm	1/4 in. 6.350 mm	3/8 in. 9.520 mm	1/2 in. 12.700 mm	5/8 in. 15.870 mm	3/4 in. 19.050 mm	1 in. 25.400 mm	1 1/4 in. 31.750 mm	1 1/2 in. 38.100 mm	
Common structural steels	≤100 Bhn	•	•	•	•	•	•	•	•	•	•	•	•
	>100-260 Bhn	•	•	•	•	•	•	•	•	•	•	•	•
Free-cutting steels	≤24 Rc	•	•	•	•	•	•	•	•	•	•	•	•
	>24-30 Rc	130	•	0.0040	0.0065	0.0080	0.0100	•	•	•	•	•	•
Unalloyed heat-treatable steels	≤16 Rc	•	•	•	•	•	•	•	•	•	•	•	•
	16-24 Rc	•	•	•	•	•	•	•	•	•	•	•	•
	24-30 Rc	•	•	•	•	•	•	•	•	•	•	•	•
Alloyed heat-treatable steels	24-30 Rc	•	•	•	•	•	•	•	•	•	•	•	•
	>30-38 Rc	•	•	•	•	•	•	•	•	•	•	•	•
Unalloyed case hardened steels	≤230 Bhn	•	•	•	•	•	•	•	•	•	•	•	•
Alloyed case hardened steels	24-30 Rc	•	•	•	•	•	•	•	•	•	•	•	•
	>30-38 Rc	•	•	•	•	•	•	•	•	•	•	•	•
Nitriding steels	≥24-30 Rc	•	•	•	•	•	•	•	•	•	•	•	•
	>30-38 Rc	•	•	•	•	•	•	•	•	•	•	•	•
Tool steels	≤24 Rc	•	•	•	•	•	•	•	•	•	•	•	•
	>24-30 Rc	•	•	•	•	•	•	•	•	•	•	•	•
High speed steels	≥14-30 Rc	•	•	•	•	•	•	•	•	•	•	•	•
Spring steels	≤330 Bhn	•	•	•	•	•	•	•	•	•	•	•	•
Stainless steels, sulphured austenitic martensitic	≤24 Rc	•	•	•	•	•	•	•	•	•	•	•	•
	≤24 Rc	•	•	•	•	•	•	•	•	•	•	•	•
	≤24 Rc	•	•	•	•	•	•	•	•	•	•	•	•
Hardened steels	≤40-48 Rc	•	•	•	•	•	•	•	•	•	•	•	•
	>48-60 Rc	•	•	•	•	•	•	•	•	•	•	•	•
Special alloys	≤38 Rc	•	•	•	•	•	•	•	•	•	•	•	•
Cast iron	≤240 Bhn	180	•	0.0065	0.0100	0.0125	0.0160	•	•	•	•	•	•
	<300 Bhn	130	•	0.0065	0.0100	0.0125	0.0160	•	•	•	•	•	•
Spheroidal graphite iron and malleable cast iron	≤240 Bhn	120	•	0.0065	0.0100	0.0125	0.0160	•	•	•	•	•	•
	<300 Bhn	100	•	0.0065	0.0100	0.0125	0.0160	•	•	•	•	•	•
Chilled cast iron	≤350 Bhn	•	•	•	•	•	•	•	•	•	•	•	•
Ti and Ti-alloys	≤24 Rc	•	•	•	•	•	•	•	•	•	•	•	•
	>24-38 Rc	•	•	•	•	•	•	•	•	•	•	•	•
Aluminium and Al-alloys	≤120 Bhn	345	•	0.0080	0.0125	0.0160	0.0200	•	•	•	•	•	•
Al wrought alloys	≤150 Bhn	260	•	0.0080	0.0125	0.0160	0.0200	•	•	•	•	•	•
Al cast alloys ≤ 10 % Si	≤200 Bhn	340	•	0.0065	0.0100	0.0125	0.0160	•	•	•	•	•	•
	> 10 % Si	260	•	0.0065	0.0100	0.0125	0.0160	•	•	•	•	•	•
Magnesium alloys	≤150 Bhn	345	•	0.0065	0.0100	0.0125	0.0160	•	•	•	•	•	•
Copper, low-alloyed	≤120 Bhn	180	•	0.0050	0.0080	0.0100	0.0125	•	•	•	•	•	•
Brass, short-chipping	≤200 Bhn	•	•	•	•	•	•	•	•	•	•	•	•
	long-chipping	≤200 Bhn	•	•	•	•	•	•	•	•	•	•	•
Bronze, short-chipping	≤200 Bhn	•	•	•	•	•	•	•	•	•	•	•	•
	>200-260 Bhn	•	•	•	•	•	•	•	•	•	•	•	•
Bronze, long-chipping	≤24 Rc	130	•	0.0040	0.0065	0.0080	0.0100	•	•	•	•	•	•
	>24-30 Rc	100	•	0.0040	0.0065	0.0080	0.0100	•	•	•	•	•	•
Duroplastics	—	85	•	0.0040	0.0065	0.0080	0.0100	•	•	•	•	•	•
Thermoplastics	—	•	•	•	•	•	•	•	•	•	•	•	•
Reinforced plastics - Kevlar	—	•	•	•	•	•	•	•	•	•	•	•	•
Reinforced plastics - GFK / CFK	—	•	•	•	•	•	•	•	•	•	•	•	•

$RPM = \frac{SFM}{DIAM. \text{ in.}} \times 3.82$ $IPM = IPR \times RPM$

$HOLE \ DEPTH \text{ in.} \times 60 = \text{Cut Time}$
IPM

$mm = \text{in.} \times 25.40$

$m/min. = SFM \div 3.28$
 $mm/rev. = IPR \div 25.40$

Bar = PSI ÷ 14.50
Liter = Gal. ÷ 3.79

Series # 1242

Material group	Hardness	SFM	Feed Rate - IPR										
			1/16 in. 1.590 mm	1/8 in. 3.170 mm	1/4 in. 6.350 mm	3/8 in. 9.520 mm	1/2 in. 12.700 mm	5/8 in. 15.870 mm	3/4 in. 19.050 mm	1 in. 25.400 mm	1 1/4 in. 31.750 mm	1 1/2 in. 38.100 mm	
Common structural steels	≤100 Bhn >100-260 Bhn	330 280	• •	0.0050 0.0040	0.0080 0.0065	0.0100 0.0080	0.0125 0.0080	0.0175 0.0100	0.0140 0.0110	0.0160 0.0125	• •	• •	• •
Free-cutting steels	≤24 Rc >24-30 Rc	360 280	• •	0.0065 0.0050	0.0100 0.0080	0.0125 0.0100	0.0160 0.0125	0.0180 0.0140	0.0200 0.0160	• •	• •	• •	
Unalloyed heat-treatable steels	≤16 Rc 16-24 Rc 24-30 Rc	260 280 260	• • •	0.0050 0.0050 0.0050	0.0080 0.0080 0.0080	0.0100 0.0100 0.0100	0.0125 0.0125 0.0125	0.0140 0.0140 0.0140	0.0160 0.0160 0.0160	• • •	• • •	• • •	
Alloyed heat-treatable steels	24-30 Rc >30-38 Rc	260 245	• •	0.0050 0.0040	0.0080 0.0065	0.0100 0.0080	0.0125 0.0100	0.0140 0.0110	0.0160 0.0125	• •	• •	• •	
Unalloyed case hardened steels	≤230 Bhn	330	•	0.0065	0.0100	0.0125	0.0160	0.0180	0.0200	•	•	•	
Alloyed case hardened steels	24-30 Rc >30-38 Rc	295 215	• •	0.0050 0.0030	0.0080 0.0050	0.0100 0.0065	0.0125 0.0080	0.0140 0.0090	0.0160 0.0100	• •	• •	• •	
Nitriding steels	≥24-30 Rc >30-38 Rc	245 230	• •	0.0040 0.0030	0.0065 0.0050	0.0080 0.0065	0.0100 0.0080	0.0110 0.0090	0.0125 0.0100	• •	• •	• •	
Tool steels	≤24 Rc >24-30 Rc	165 130	• •	0.0050 0.0030	0.0080 0.0050	0.0100 0.0065	0.0125 0.0080	0.0140 0.0090	0.0160 0.0100	• •	• •	• •	
High speed steels	≥14-30 Rc	•	•	•	•	•	•	•	•	•	•	•	
Spring steels	≤330 Bhn	115	•	0.0020	0.0030	0.0040	0.0050	0.0055	0.0065	•	•	•	
Stainless steels, sulphured	≤24 Rc	95	•	0.0025	0.0040	0.0050	0.0065	0.0065	0.0080	•	•	•	
Stainless steels, austenitic	≤24 Rc	90	•	0.0025	0.0040	0.0050	0.0065	0.0065	0.0080	•	•	•	
Stainless steels, martensitic	≤24 Rc	90	•	0.0020	0.0030	0.0040	0.0050	0.0050	0.0065	•	•	•	
Hardened steels	≤40-48 Rc >48-60 Rc	• •	• •	• •	• •	• •	• •	• •	• •	• •	• •	• •	
Special alloys	≤38 Rc	•	•	•	•	•	•	•	•	•	•	•	
Cast iron	≤240 Bhn <300 Bhn	525 395	• •	0.0065 0.0050	0.0100 0.0080	0.0125 0.0100	0.0160 0.0125	0.0180 0.0140	0.0200 0.0160	• •	• •	• •	
Spheroidal graphite iron and malleable cast iron	≤240 Bhn <300 Bhn	395 310	• •	0.0050 0.0050	0.0080 0.0080	0.0100 0.0100	0.0125 0.0125	0.0140 0.0140	0.0160 0.0160	• •	• •	• •	
Chilled cast iron	≤350 Bhn	•	•	•	•	•	•	•	•	•	•	•	
Ti and Ti-alloys	≤24 Rc >24-38 Rc	• •	• •	• •	• •	• •	• •	• •	• •	• •	• •	• •	
Aluminium and Al-alloys	≤120 Bhn	655	•	0.0080	0.0125	0.0160	0.0200	0.0220	0.0245	•	•	•	
Al wrought alloys	≤150 Bhn	655	•	0.0080	0.0125	0.0160	0.0200	0.0220	0.0245	•	•	•	
Al cast alloys ≤ 10 % Si	≤200 Bhn	560	•	0.0080	0.0125	0.0160	0.0200	0.0220	0.0245	•	•	•	
Al cast alloys > 10 % Si	≤200 Bhn	460	•	0.0065	0.0100	0.0125	0.0160	0.0180	0.0200	•	•	•	
Magnesium alloys	≤150 Bhn	•	•	•	•	•	•	•	•	•	•	•	
Copper, low-alloyed	≤120 Bhn	•	•	•	•	•	•	•	•	•	•	•	
Brass, short-chipping	≤200 Bhn	•	•	•	•	•	•	•	•	•	•	•	
Brass, long-chipping	≤200 Bhn	•	•	•	•	•	•	•	•	•	•	•	
Bronze, short-chipping	≤200 Bhn	•	•	•	•	•	•	•	•	•	•	•	
Bronze, long-chipping	>200-260 Bhn	•	•	•	•	•	•	•	•	•	•	•	
Duroplastics	—	•	•	•	•	•	•	•	•	•	•	•	
Thermoplastics	—	•	•	•	•	•	•	•	•	•	•	•	
Reinforced plastics - Kevlar	—	•	•	•	•	•	•	•	•	•	•	•	
Reinforced plastics - GFK / CFK	—	•	•	•	•	•	•	•	•	•	•	•	

Series # 1243

Material group	Hardness	SFM	Feed Rate - IPR										
			1/16 in. 1.590 mm	1/8 in. 3.170 mm	1/4 in. 6.350 mm	3/8 in. 9.520 mm	1/2 in. 12.700 mm	5/8 in. 15.870 mm	3/4 in. 19.050 mm	1 in. 25.400 mm	1 1/4 in. 31.750 mm	1 1/2 in. 38.100 mm	
Common structural steels	≤100 Bhn >100-260 Bhn	330 280	• •	0.0050 0.0040	0.0080 0.0065	0.0100 0.0080	0.0125 0.0080	0.0175 0.0100	0.0140 0.0110	0.0160 0.0125	• •	• •	• •
Free-cutting steels	≤24 Rc >24-30 Rc	360 280	• •	0.0065 0.0050	0.0100 0.0080	0.0125 0.0100	0.0160 0.0125	0.0180 0.0140	0.0200 0.0160	• •	• •	• •	
Unalloyed heat-treatable steels	≤16 Rc 16-24 Rc 24-30 Rc	260 280 260	• • •	0.0050 0.0050 0.0050	0.0080 0.0080 0.0080	0.0100 0.0100 0.0100	0.0125 0.0125 0.0125	0.0140 0.0140 0.0140	0.0160 0.0160 0.0160	• • •	• • •	• • •	
Alloyed heat-treatable steels	24-30 Rc >30-38 Rc	260 245	• •	0.0050 0.0040	0.0080 0.0065	0.0100 0.0080	0.0125 0.0100	0.0140 0.0110	0.0160 0.0125	• •	• •	• •	
Unalloyed case hardened steels	≤230 Bhn	330	•	0.0065	0.0100	0.0125	0.0160	0.0180	0.0200	•	•	•	
Alloyed case hardened steels	24-30 Rc >30-38 Rc	295 215	• •	0.0050 0.0030	0.0080 0.0050	0.0100 0.0065	0.0125 0.0080	0.0140 0.0090	0.0160 0.0100	• •	• •	• •	
Nitriding steels	≥24-30 Rc >30-38 Rc	245 230	• •	0.0040 0.0030	0.0065 0.0050	0.0080 0.0065	0.0100 0.0080	0.0110 0.0090	0.0125 0.0100	• •	• •	• •	
Tool steels	≤24 Rc >24-30 Rc	165 130	• •	0.0050 0.0030	0.0080 0.0050	0.0100 0.0065	0.0125 0.0080	0.0140 0.0090	0.0160 0.0100	• •	• •	• •	
High speed steels	≥14-30 Rc	•	•	•	•	•	•	•	•	•	•	•	
Spring steels	≤330 Bhn	115	•	0.0020	0.0030	0.0040	0.0050	0.0055	0.0065	•	•	•	
Stainless steels, sulphured	≤24 Rc	95	•	0.0025	0.0040	0.0050	0.0065	0.0065	0.0080	•	•	•	
Stainless steels, austenitic	≤24 Rc	90	•	0.0025	0.0040	0.0050	0.0065	0.0065	0.0080	•	•	•	
Stainless steels, martensitic	≤24 Rc	90	•	0.0020	0.0030	0.0040	0.0050	0.0050	0.0065	•	•	•	
Hardened steels	≤40-48 Rc >48-60 Rc	• •	• •	• •	• •	• •	• •	• •	• •	• •	• •	• •	
Special alloys	≤38 Rc	•	•	•	•	•	•	•	•	•	•	•	
Cast iron	≤240 Bhn <300 Bhn	525 395	• •	0.0065 0.0050	0.0100 0.0080	0.0125 0.0100	0.0160 0.0125	0.0180 0.0140	0.0200 0.0160	• •	• •	• •	
Spheroidal graphite iron and malleable cast iron	≤240 Bhn <300 Bhn	395 310	• •	0.0050 0.0050	0.0080 0.0080	0.0100 0.0100	0.0125 0.0125	0.0140 0.0140	0.0160 0.0160	• •	• •	• •	
Chilled cast iron	≤350 Bhn	•	•	•	•	•	•	•	•	•	•	•	
Ti and Ti-alloys	≤24 Rc >24-38 Rc	• •	• •	• •	• •	• •	• •	• •	• •	• •	• •	• •	
Aluminium and Al-alloys	≤120 Bhn	655	•	0.0080	0.0125	0.0160	0.0200	0.0220	0.0245	•	•	•	
Al wrought alloys	≤150 Bhn	655	•	0.0080	0.0125	0.0160	0.0200	0.0220	0.0245	•	•	•	
Al cast alloys ≤ 10 % Si	≤200 Bhn	560	•	0.0080	0.0125	0.0160	0.0200	0.0220	0.0245	•	•	•	
Al cast alloys > 10 % Si	≤200 Bhn	460	•	0.0065	0.0100	0.0125	0.0160	0.0180	0.0200	•	•	•	
Magnesium alloys	≤150 Bhn	•	•	•	•	•	•	•	•	•	•	•	
Copper, low-alloyed	≤120 Bhn	•	•	•	•	•	•	•	•	•	•	•	
Brass, short-chipping	≤200 Bhn	•	•	•	•	•	•	•	•	•	•	•	
Brass, long-chipping	≤200 Bhn	•	•	•	•	•	•	•	•	•	•	•	
Bronze, short-chipping	≤200 Bhn	•	•	•	•	•	•	•	•	•	•	•	
Bronze, long-chipping	>200-260 Bhn	•	•	•	•	•	•	•	•	•	•	•	
Duroplastics	—	•	•	•	•	•	•	•	•	•	•	•	
Thermoplastics	—	•	•	•	•	•	•	•	•	•	•	•	
Reinforced plastics - Kevlar	—	•	•	•	•	•	•	•	•	•	•	•	
Reinforced plastics - GFK / CFK	—	•	•	•	•	•	•	•	•	•	•	•	

Using These Tables. The Speeds & Feeds listed below are conservative recommendations for initial setup. In actual use, depending on the machining environment and workpiece material, significantly higher speeds and feeds may be achievable. Using the below as a starting point, cutting speed/feed can be gradually adjusted upwards until the optimum settings per application are found.
 Questions? Contact us by telephone at (800) 776-6170.

Series # 1452

Material group	Hardness	SFM	Feed Rate - IPR										
			1/16 in. 1.590 mm	1/8 in. 3.170 mm	1/4 in. 6.350 mm	3/8 in. 9.520 mm	1/2 in. 12.700 mm	5/8 in. 15.870 mm	3/4 in. 19.050 mm	1 in. 25.400 mm	1 1/4 in. 31.750 mm	1 1/2 in. 38.100 mm	
Common structural steels	≤100 Bhn >100-260 Bhn	280 250	•	0.0030	0.0050	0.0065	0.0080	0.0080	0.0065	•	•	•	•
Free-cutting steels	≤24 Rc >24-30 Rc	300 220	•	0.0040	0.0065	0.0080	0.0100	0.0100	•	•	•	•	•
Unalloyed heat-treatable steels	≤16 Rc 16-24 Rc 24-30 Rc	195 185 170	•	0.0030	0.0050	0.0065	0.0080	0.0080	•	•	•	•	•
Alloyed heat-treatable steels	24-30 Rc >30-38 Rc	170 140	•	0.0030	0.0050	0.0065	0.0080	0.0080	•	•	•	•	•
Unalloyed case hardened steels	≤230 Bhn	195	•	0.0040	0.0065	0.0080	0.0100	0.0100	•	•	•	•	•
Alloyed case hardened steels	24-30 Rc >30-38 Rc	170 140	•	0.0030 0.0025	0.0050 0.0040	0.0065 0.0050	0.0080 0.0065	0.0080 0.0065	•	•	•	•	•
Nitriding steels	≥24-30 Rc >30-38 Rc	185 155	•	0.0025 0.0025	0.0040 0.0040	0.0050 0.0050	0.0065 0.0065	0.0065 0.0065	•	•	•	•	•
Tool steels	≤24 Rc >24-30 Rc	95 80	•	0.0025 0.0025	0.0040 0.0040	0.0050 0.0050	0.0065 0.0065	0.0065 0.0065	•	•	•	•	•
High speed steels	≥14-30 Rc	70	•	0.0020	0.0030	0.0040	0.0050	0.0050	•	•	•	•	•
Spring steels	≤330 Bhn	•	•	•	•	•	•	•	•	•	•	•	•
Stainless steels, sulphured austenitic martensitic	≤24 Rc 55 ≤24 Rc	55 55 40	•	0.0030 0.0030 0.0025	0.0050 0.0050 0.0040	0.0065 0.0065 0.0050	0.0080 0.0065 0.0065	0.0080 0.0080 0.0065	•	•	•	•	•
Hardened steels	≤40-48 Rc >48-60 Rc	• •	•	•	•	•	•	•	•	•	•	•	•
Special alloys	≤38 Rc	•	•	•	•	•	•	•	•	•	•	•	•
Cast iron	≤240 Bhn <300 Bhn	360 255	•	0.0050 0.0050	0.0080 0.0080	0.0100 0.0100	0.0125 0.0125	0.0125 0.0125	•	•	•	•	•
Spheroidal graphite iron and malleable cast iron	≤240 Bhn <300 Bhn	255 230	•	0.0050 0.0050	0.0080 0.0080	0.0100 0.0100	0.0125 0.0125	0.0125 0.0125	•	•	•	•	•
Chilled cast iron	≤350 Bhn	•	•	•	•	•	•	•	•	•	•	•	•
Ti and Ti-alloys	≤24 Rc >24-38 Rc	50 40	•	0.0030 0.0025	0.0050 0.0040	0.0065 0.0050	0.0080 0.0065	0.0080 0.0065	•	•	•	•	•
Aluminium and Al-alloys	≤120 Bhn	435	•	0.0065	0.0100	0.0125	0.0160	0.0160	•	•	•	•	•
Al wrought alloys	≤150 Bhn	360	•	0.0050	0.0080	0.0100	0.0125	0.0125	•	•	•	•	•
Al cast alloys ≤ 10 % Si > 10 % Si	≤200 Bhn ≤200 Bhn	435 360	•	0.0065 0.0050	0.0100 0.0080	0.0125 0.0100	0.0160 0.0125	0.0160 0.0125	•	•	•	•	•
Magnesium alloys	≤150 Bhn	510	•	0.0050	0.0080	0.0100	0.0125	0.0125	•	•	•	•	•
Copper, low-alloyed	≤120 Bhn	•	•	•	•	•	•	•	•	•	•	•	•
Brass, short-chipping long-chipping	≤200 Bhn ≤200 Bhn	535 500	•	0.0050 0.0040	0.0080 0.0065	0.0100 0.0080	0.0125 0.0100	0.0125 0.0100	•	•	•	•	•
Bronze, short-chipping	≤200 Bhn >200-260 Bhn	• •	•	•	•	•	•	•	•	•	•	•	•
Bronze, long-chipping	≤24 Rc >24-30 Rc	• •	•	•	•	•	•	•	•	•	•	•	•
Duroplastics	—	•	•	•	•	•	•	•	•	•	•	•	•
Thermoplastics	—	•	•	•	•	•	•	•	•	•	•	•	•
Reinforced plastics - Kevlar	—	•	•	•	•	•	•	•	•	•	•	•	•
Reinforced plastics - GFK / CFK	—	•	•	•	•	•	•	•	•	•	•	•	•

Series # 1662

Material group	Hardness	SFM	Feed Rate - IPR										
			1/16 in. 1.590 mm	1/8 in. 3.170 mm	1/4 in. 6.350 mm	3/8 in. 9.520 mm	1/2 in. 12.700 mm	5/8 in. 15.870 mm	3/4 in. 19.050 mm	1 in. 25.400 mm	1 1/4 in. 31.750 mm	1 1/2 in. 38.100 mm	
Common structural steels	≤100 Bhn >100-260 Bhn	360 295	•	0.0050	0.0080	0.0100	0.0125	0.0125	0.0100	0.0140	0.0160	•	•
Free-cutting steels	≤24 Rc >24-30 Rc	425 360	•	0.0065	0.0100	0.0125	0.0160	0.0160	0.0180	0.0180	0.0200	•	•
Unalloyed heat-treatable steels	≤16 Rc 16-24 Rc 24-30 Rc	325 310 295	•	0.0065	0.0100	0.0125	0.0160	0.0160	0.0180	0.0180	0.0200	•	•
Alloyed heat-treatable steels	24-30 Rc >30-38 Rc	295 260	•	0.0050	0.0080	0.0100	0.0125	0.0125	0.0140	0.0140	0.0160	•	•
Unalloyed case hardened steels	≤230 Bhn	360	•	0.0065	0.0100	0.0125	0.0160	0.0160	0.0180	0.0200	•	•	•
Alloyed case hardened steels	24-30 Rc >30-38 Rc	295 210	•	0.0050 0.0030	0.0080 0.0050	0.0100 0.0065	0.0125 0.0080	0.0125 0.0080	0.0140 0.0090	0.0160 0.0100	•	•	•
Nitriding steels	≥24-30 Rc >30-38 Rc	260 245	•	0.0050 0.0030	0.0080 0.0050	0.0100 0.0065	0.0125 0.0080	0.0125 0.0080	0.0140 0.0090	0.0160 0.0100	•	•	•
Tool steels	≤24 Rc >24-30 Rc	180 130	•	0.0040 0.0030	0.0065 0.0050	0.0080 0.0065	0.0100 0.0080	0.0100 0.0080	0.0110 0.0090	0.0125 0.0100	•	•	•
High speed steels	≥14-30 Rc	145	•	0.0025	0.0040	0.0050	0.0065	0.0065	0.0070	0.0080	•	•	•
Spring steels	≤330 Bhn	145	•	0.0020	0.0030	0.0040	0.0050	0.0050	0.0055	0.0065	•	•	•
Stainless steels, sulphured austenitic martensitic	≤24 Rc 130 ≤24 Rc	145 130 110	•	0.0030 0.0030 0.0030	0.0050 0.0050 0.0050	0.0065 0.0065 0.0065	0.0080 0.0080 0.0080	0.0080 0.0080 0.0080	0.0090 0.0090 0.0090	0.0100 0.0100 0.0100	•	•	•
Hardened steels	≤40-48 Rc >48-60 Rc	130 80	•	0.0020 0.0015	0.0030 0.0025	0.0040 0.0030	0.0050 0.0040	0.0050 0.0040	0.0055 0.0045	0.0065 0.0050	•	•	•
Special alloys	≤38 Rc	80	•	0.0025	0.0040	0.0050	0.0065	0.0065	0.0070	0.0080	•	•	•
Cast iron	≤240 Bhn <300 Bhn	620 360	•	0.0080 0.0080	0.0125 0.0125	0.0160 0.0160	0.0200 0.0200	0.0200 0.0200	0.0220 0.0220	0.0245 0.0245	•	•	•
Spheroidal graphite iron and malleable cast iron	≤240 Bhn <300 Bhn	360 310	•	0.0080 0.0065	0.0125 0.0100	0.0160 0.0125	0.0200 0.0160	0.0200 0.0180	0.0220 0.0180	0.0245 0.0200	•	•	•
Chilled cast iron	≤350 Bhn	95	•	0.0020	0.0030	0.0040	0.0050	0.0050	0.0055	0.0065	•	•	•
Ti and Ti-alloys	≤24 Rc >24-38 Rc	110 95	•	0.0025 0.0020	0.0040 0.0030	0.0050 0.0040	0.0065 0.0050	0.0065 0.0050	0.0070 0.0055	0.0080 0.0065	•	•	•
Aluminium and Al-alloys	≤120 Bhn	785	•	0.0080	0.0125	0.0160	0.0200	0.0200	0.0220	0.0245	•	•	•
Al wrought alloys	≤150 Bhn	785	•	0.0080	0.0125	0.0160	0.0200	0.0200	0.0220	0.0245	•	•	•
Al cast alloys ≤ 10 % Si > 10 % Si	≤200 Bhn ≤200 Bhn	655 555	•	0.0080 0.0080	0.0125 0.0125	0.0160 0.0160	0.0200 0.0200	0.0200 0.0200	0.0220 0.0220	0.0245 0.0245	•	•	•
Magnesium alloys	≤150 Bhn	750	•	0.0065	0.0100	0.0125	0.0160	0.0160	0.0180	0.0200	•	•	•
Copper, low-alloyed	≤120 Bhn	310	•	0.0050	0.0080	0.0100	0.0125	0.0125	0.0140	0.0160	•	•	•
Brass, short-chipping long-chipping	≤200 Bhn ≤200 Bhn	820 555	•	0.0065 0.0050	0.0100 0.0080	0.0125 0.0100	0.0160 0.0125	0.0160 0.0125	0.0180 0.0140	0.0200 0.0160	•	•	•
Bronze, short-chipping	≤200 Bhn >200-260 Bhn	310 260	•	0.0050 0.0040	0.0080 0.0065	0.0100 0.0080	0.0125 0.0100	0.0125 0.0100	0.0140 0.0110	0.0160 0.0125	•	•	•
Bronze, long-chipping	≤24 Rc >24-30 Rc	225 195	•	0.0040 0.0040	0.0065 0.0065	0.0080 0.0080	0.0100 0.0100	0.0100 0.0100	0.0110 0.0110	0.0125 0.0125	•	•	•
Duroplastics	—	•	•	•	•	•	•	•	•	•	•	•	•
Thermoplastics	—	•	•	•	•	•	•	•	•	•	•	•	•
Reinforced plastics - Kevlar	—	•	•	•	•	•	•	•	•	•	•	•	•
Reinforced plastics - GFK / CFK	—	•	•	•	•	•	•	•	•	•	•	•	•

RPM = $\frac{\text{SFM}}{\text{DIAM. in.}} \times 3.82$ $\text{IPM} = \text{IPR} \times \text{RPM}$

$\frac{\text{HOLE DEPTH in.}}{\text{IPM}} \times 60 = \text{Cut Time}$ $\text{mm} = \text{in.} \times 25.40$

$\text{m/min.} = \text{SFM} \div 3.28$ $\text{Bar} = \text{PSI} \div 14.50$
 $\text{mm/rev.} = \text{IPR} \times 25.40$ $\text{Liter} = \text{Gal.} \div 3.79$

Series # 1702

Material group	Hardness	SFM	Feed Rate - IPR									
			1/16 in. 1.590 mm	1/8 in. 3.170 mm	1/4 in. 6.350 mm	3/8 in. 9.520 mm	1/2 in. 12.700 mm	5/8 in. 15.870 mm	3/4 in. 19.050 mm	1 in. 25.400 mm	1 1/4 in. 31.750 mm	1 1/2 in. 38.100 mm
Common structural steels	≤100 Bhn	325	•	0.0050	0.0080	0.0100	0.0125	0.0125	•	•	•	•
	>100-260 Bhn	275	•	0.0040	0.0065	0.0080	0.0100	0.0100	•	•	•	•
Free-cutting steels	≤24 Rc	360	•	0.0065	0.0100	0.0125	0.0160	0.0160	•	•	•	•
	>24-30 Rc	275	•	0.0050	0.0080	0.0100	0.0125	0.0125	•	•	•	•
Unalloyed heat-treatable steels	≤16 Rc	295	•	0.0050	0.0080	0.0100	0.0125	0.0125	•	•	•	•
	16-24 Rc	275	•	0.0050	0.0080	0.0100	0.0125	0.0125	•	•	•	•
	24-30 Rc	260	•	0.0050	0.0080	0.0100	0.0125	0.0125	•	•	•	•
Alloyed heat-treatable steels	24-30 Rc	260	•	0.0050	0.0080	0.0100	0.0125	0.0125	•	•	•	•
	>30-38 Rc	245	•	0.0040	0.0065	0.0080	0.0100	0.0100	•	•	•	•
Unalloyed case hardened steels	≤230 Bhn	325	•	0.0065	0.0100	0.0125	0.0160	0.0160	•	•	•	•
Alloyed case hardened steels	24-30 Rc	295	•	0.0050	0.0080	0.0100	0.0125	0.0125	•	•	•	•
	>30-38 Rc	210	•	0.0030	0.0050	0.0065	0.0080	0.0080	•	•	•	•
Nitriding steels	≥24-30 Rc	245	•	0.0040	0.0065	0.0080	0.0100	0.0100	•	•	•	•
	>30-38 Rc	225	•	0.0030	0.0050	0.0065	0.0080	0.0080	•	•	•	•
Tool steels	≤24 Rc	160	•	0.0040	0.0065	0.0080	0.0100	0.0100	•	•	•	•
	>24-30 Rc	130	•	0.0030	0.0050	0.0065	0.0080	0.0080	•	•	•	•
High speed steels	≥14-30 Rc	130	•	0.0025	0.0040	0.0050	0.0065	0.0065	•	•	•	•
Spring steels	≤330 Bhn	110	•	0.0020	0.0030	0.0040	0.0050	0.0050	•	•	•	•
Stainless steels, sulphured austenitic martensitic	≤24 Rc	115	•	0.0025	0.0040	0.0050	0.0065	0.0065	•	•	•	•
	≤24 Rc	110	•	0.0025	0.0040	0.0050	0.0065	0.0065	•	•	•	•
	≤24 Rc	110	•	0.0020	0.0030	0.0040	0.0050	0.0050	•	•	•	•
Hardened steels	≤40-48 Rc	110	•	0.0020	0.0030	0.0040	0.0050	0.0050	•	•	•	•
	>48-60 Rc	65	•	0.0015	0.0025	0.0030	0.0040	0.0040	•	•	•	•
Special alloys	≤38 Rc	65	•	0.0025	0.0040	0.0050	0.0065	0.0065	•	•	•	•
Cast iron	≤240 Bhn	520	•	0.0065	0.0100	0.0125	0.0160	0.0160	•	•	•	•
	<300 Bhn	390	•	0.0065	0.0100	0.0125	0.0160	0.0160	•	•	•	•
Spheroidal graphite iron and malleable cast iron	≤240 Bhn	390	•	0.0065	0.0100	0.0125	0.0160	0.0160	•	•	•	•
	<300 Bhn	310	•	0.0065	0.0100	0.0125	0.0160	0.0160	•	•	•	•
Chilled cast iron	≤350 Bhn	80	•	0.0020	0.0030	0.0040	0.0050	0.0050	•	•	•	•
Ti and Ti-alloys	≤24 Rc	95	•	0.0020	0.0030	0.0040	0.0050	0.0050	•	•	•	•
	>24-38 Rc	80	•	0.0020	0.0030	0.0040	0.0050	0.0050	•	•	•	•
Aluminium and Al-alloys	≤120 Bhn	655	•	0.0080	0.0125	0.0160	0.0200	0.0200	•	•	•	•
Al wrought alloys	≤150 Bhn	655	•	0.0080	0.0125	0.0160	0.0200	0.0200	•	•	•	•
Al cast alloys ≤ 10 % Si	≤200 Bhn	555	•	0.0080	0.0125	0.0160	0.0200	0.0200	•	•	•	•
	> 10 % Si	455	•	0.0065	0.0100	0.0125	0.0160	0.0160	•	•	•	•
Magnesium alloys	≤150 Bhn	655	•	0.0065	0.0100	0.0125	0.0160	0.0160	•	•	•	•
Copper, low-alloyed	≤120 Bhn	260	•	0.0050	0.0080	0.0100	0.0125	0.0125	•	•	•	•
Brass, short-chipping long-chipping	≤200 Bhn	685	•	0.0065	0.0100	0.0125	0.0160	0.0160	•	•	•	•
	≤200 Bhn	455	•	0.0050	0.0080	0.0100	0.0125	0.0125	•	•	•	•
Bronze, short-chipping	≤200 Bhn	260	•	0.0040	0.0065	0.0080	0.0100	0.0100	•	•	•	•
	>200-260 Bhn	210	•	0.0040	0.0065	0.0080	0.0100	0.0100	•	•	•	•
Bronze, long-chipping	≤24 Rc	195	•	0.0030	0.0050	0.0065	0.0080	0.0080	•	•	•	•
	>24-30 Rc	145	•	0.0030	0.0050	0.0065	0.0080	0.0080	•	•	•	•
Duroplastics	-	•	•	•	•	•	•	•	•	•	•	•
Thermoplastics	-	•	•	•	•	•	•	•	•	•	•	•
Reinforced plastics - Kevlar	-	•	•	•	•	•	•	•	•	•	•	•
Reinforced plastics - GFK / CFK	-	•	•	•	•	•	•	•	•	•	•	•

Series # 2458

Material group	Hardness	SFM	Feed Rate - IPR									
			1/16 in. 1.590 mm	1/8 in. 3.170 mm	1/4 in. 6.350 mm	3/8 in. 9.520 mm	1/2 in. 12.700 mm	5/8 in. 15.870 mm	3/4 in. 19.050 mm	1 in. 25.400 mm	1 1/4 in. 31.750 mm	1 1/2 in. 38.100 mm
Common structural steels	≤100 Bhn	•	•	•	•	•	•	•	•	•	•	•
	>100-260 Bhn	•	•	•	•	•	•	•	•	•	•	•
Free-cutting steels	≤24 Rc	•	•	•	•	•	•	•	•	•	•	•
	>24-30 Rc	•	•	•	•	•	•	•	•	•	•	•
Unalloyed heat-treatable steels	≤16 Rc	•	•	•	•	•	•	•	•	•	•	•
	16-24 Rc	•	•	•	•	•	•	•	•	•	•	•
	24-30 Rc	•	•	•	•	•	•	•	•	•	•	•
Alloyed heat-treatable steels	24-30 Rc	•	•	•	•	•	•	•	•	•	•	•
	>30-38 Rc	•	•	•	•	•	•	•	•	•	•	•
Unalloyed case hardened steels	≤230 Bhn	•	•	•	•	•	•	•	•	•	•	•
Alloyed case hardened steels	24-30 Rc	•	•	•	•	•	•	•	•	•	•	•
	>30-38 Rc	75	0.0010	0.0025	0.0040	0.0050	0.0065	0.0065	•	•	•	•
Nitriding steels	≥24-30 Rc	•	•	•	•	•	•	•	•	•	•	•
	>30-38 Rc	65	0.0010	0.0025	0.0040	0.0050	0.0065	0.0065	•	•	•	•
Tool steels	≤24 Rc	•	•	•	•	•	•	•	•	•	•	•
	>24-30 Rc	55	0.0010	0.0025	0.0040	0.0050	0.0065	0.0065	•	•	•	•
High speed steels	≥14-30 Rc	55	0.0010	0.0025	0.0040	0.0050	0.0065	0.0065	•	•	•	•
Spring steels	≤330 Bhn	40	0.0007	0.0020	0.0030	0.0040	0.0050	0.0050	•	•	•	•
Stainless steels, sulphured austenitic martensitic	≤24 Rc	75	0.0012	0.0030	0.0050	0.0065	0.0080	0.0080	•	•	•	•
	≤24 Rc	60	0.0010	0.0025	0.0040	0.0050	0.0065	0.0065	•	•	•	•
	≤24 Rc	65	0.0010	0.0025	0.0040	0.0050	0.0065	0.0065	•	•	•	•
Hardened steels	≤40-48 Rc	20	0.0005	0.0015	0.0025	0.0030	0.0040	0.0040	•	•	•	•
	>48-60 Rc	•	•	•	•	•	•	•	•	•	•	•
Special alloys	≤38 Rc	30	0.0005	0.0015	0.0025	0.0030	0.0040	0.0040	•	•	•	•
Cast iron	≤240 Bhn	•	•	•	•	•	•	•	•	•	•	•
	<300 Bhn	•	•	•	•	•	•	•	•	•	•	•
Spheroidal graphite iron and malleable cast iron	≤240 Bhn	•	•	•	•	•	•	•	•	•	•	•
	<300 Bhn	•	•	•	•	•	•	•	•	•	•	•
Chilled cast iron	≤350 Bhn	40	0.0010	0.0025	0.0040	0.0050	0.0065	0.0065	•	•	•	•
Ti and Ti-alloys	≤24 Rc	50	0.0007	0.0020	0.0030	0.0040	0.0050	0.0050	•	•	•	•
	>24-38 Rc	30	0.0007	0.0020	0.0030	0.0040	0.0050	0.0050	•	•	•	•
Aluminium and Al-alloys	≤120 Bhn	•	•	•	•	•	•	•	•	•	•	•
Al wrought alloys	≤150 Bhn	•	•	•	•	•	•	•	•	•	•	•
Al cast alloys ≤ 10 % Si	≤200 Bhn	•	•	•	•	•	•	•	•	•	•	•
	> 10 % Si	•	•	•	•	•	•	•	•	•	•	•
Magnesium alloys	≤150 Bhn	•	•	•	•	•	•	•	•	•	•	•
Copper, low-alloyed	≤120 Bhn	•	•	•	•	•	•	•	•	•	•	•
Brass, short-chipping long-chipping	≤200 Bhn	•	•	•	•	•	•	•	•	•	•	•
	≤200 Bhn	•	•	•	•	•	•	•	•	•	•	•
Bronze, short-chipping	≤200 Bhn	•	•	•	•	•	•	•	•	•	•	•
	>200-260 Bhn	•	•	•	•	•	•	•	•	•	•	•
Bronze, long-chipping	≤24 Rc	•	•	•	•	•	•	•	•	•	•	•
	>24-30 Rc	100	0.0012	0.0030	0.0050	0.0065	0.0080	0.0080	•	•	•	•
Duroplastics	-	•	•	•	•	•	•	•	•	•	•	•
Thermoplastics	-	•	•	•	•	•	•	•	•	•	•	•
Reinforced plastics - Kevlar	-	•	•	•	•	•	•	•	•	•	•	•
Reinforced plastics - GFK / CFK	-	•	•	•</								

RPM = $\frac{SFM}{DIAM. in.} \times 3.82$ $IPM = IPR \times RPM$

$\frac{HOLE DEPTH in.}{IPM} \times 60 = \text{Cut Time}$

mm = in. x 25.40

m/min. = $SFM \div 3.28$
mm/rev. = $IPR \times 25.40$

Bar = $PSI \div 14.50$
Liter = $Gal. \div 3.79$

Series # 2477

Material group	Hardness	SFM	Feed Rate - IPR												
			1/16 in. 1.590 mm	1/8 in. 3.170 mm	1/4 in. 6.350 mm	3/8 in. 9.520 mm	1/2 in. 12.700 mm	5/8 in. 15.870 mm	3/4 in. 19.050 mm	1 in. 25.400 mm	1 1/4 in. 31.750 mm	1 1/2 in. 38.100 mm			
Common structural steels	≤100 Bhn >100-260 Bhn	475 395	•	•	•	•	•	•	•	•	•	•	•	•	•
Free-cutting steels	≤24 Rc >24-30 Rc	560 475	•	•	•	•	•	•	•	•	•	•	•	•	•
Unalloyed heat-treatable steels	≤16 Rc 16-24 Rc 24-30 Rc	425 410 395	•	•	•	•	•	•	•	•	•	•	•	•	•
Alloyed heat-treatable steels	24-30 Rc >30-38 Rc	395 345	•	•	•	•	•	•	•	•	•	•	•	•	•
Unalloyed case hardened steels	≤230 Bhn	475	•	•	•	•	•	•	•	•	•	•	•	•	•
Alloyed case hardened steels	24-30 Rc >30-38 Rc	395 280	•	•	•	•	•	•	•	•	•	•	•	•	•
Nitriding steels	≥24-30 Rc >30-38 Rc	360 345	•	•	•	•	•	•	•	•	•	•	•	•	•
Tool steels	≤24 Rc >24-30 Rc	260 215	•	•	•	•	•	•	•	•	•	•	•	•	•
High speed steels	≥14-30 Rc	195	•	•	•	•	•	•	•	•	•	•	•	•	•
Spring steels	≤330 Bhn	195	•	•	•	•	•	•	•	•	•	•	•	•	•
Stainless steels, sulphured austenitic martensitic	≤24 Rc 180 ≤24 Rc	195 180 165	•	•	•	•	•	•	•	•	•	•	•	•	•
Hardened steels	≤40-48 Rc >48-60 Rc	180 115	•	•	•	•	•	•	•	•	•	•	•	•	•
Special alloys	≤38 Rc	115	•	•	•	•	•	•	•	•	•	•	•	•	•
Cast iron	≤240 Bhn <300 Bhn	690 525	•	•	•	•	•	•	•	•	•	•	•	•	•
Spheroidal graphite iron and malleable cast iron	≤240 Bhn <300 Bhn	460 425	•	•	•	•	•	•	•	•	•	•	•	•	•
Chilled cast iron	≤350 Bhn	130	•	•	•	•	•	•	•	•	•	•	•	•	•
Ti and Ti-alloys	≤24 Rc >24-38 Rc	150 130	•	•	•	•	•	•	•	•	•	•	•	•	•
Aluminium and Al-alloys	≤120 Bhn	1015	•	•	•	•	•	•	•	•	•	•	•	•	•
Al wrought alloys	≤150 Bhn	1015	•	•	•	•	•	•	•	•	•	•	•	•	•
Al cast alloys ≤ 10 % Si > 10 % Si	≤200 Bhn ≤200 Bhn	855 720	•	•	•	•	•	•	•	•	•	•	•	•	•
Magnesium alloys	≤150 Bhn	920	•	•	•	•	•	•	•	•	•	•	•	•	•
Copper, low-alloyed	≤120 Bhn	410	•	•	•	•	•	•	•	•	•	•	•	•	•
Brass, short-chipping long-chipping	≤200 Bhn ≤200 Bhn	1065 720	•	•	•	•	•	•	•	•	•	•	•	•	•
Bronze, short-chipping	≤200 Bhn >200-260 Bhn	410 345	•	•	•	•	•	•	•	•	•	•	•	•	•
Bronze, long-chipping	≤24 Rc >24-30 Rc	295 260	•	•	•	•	•	•	•	•	•	•	•	•	•
Duroplastics	-	•	•	•	•	•	•	•	•	•	•	•	•	•	•
Thermoplastics	-	•	•	•	•	•	•	•	•	•	•	•	•	•	•
Reinforced plastics - Kevlar	-	•	•	•	•	•	•	•	•	•	•	•	•	•	•
Reinforced plastics - GFK / CFK	-	•	•	•	•	•	•	•	•	•	•	•	•	•	•

Series # 2479

Material group	Hardness	SFM	Feed Rate - IPR												
			1/16 in. 1.590 mm	1/8 in. 3.170 mm	1/4 in. 6.350 mm	3/8 in. 9.520 mm	1/2 in. 12.700 mm	5/8 in. 15.870 mm	3/4 in. 19.050 mm	1 in. 25.400 mm	1 1/4 in. 31.750 mm	1 1/2 in. 38.100 mm			
Common structural steels	≤100 Bhn >100-260 Bhn	475 395	•	•	•	•	•	•	•	•	•	•	•	•	•
Free-cutting steels	≤24 Rc >24-30 Rc	560 475	•	•	•	•	•	•	•	•	•	•	•	•	•
Unalloyed heat-treatable steels	≤16 Rc 16-24 Rc 24-30 Rc	425 410 395	•	•	•	•	•	•	•	•	•	•	•	•	•
Alloyed heat-treatable steels	24-30 Rc >30-38 Rc	395 345	•	•	•	•	•	•	•	•	•	•	•	•	•
Unalloyed case hardened steels	≤230 Bhn	475	•	•	•	•	•	•	•	•	•	•	•	•	•
Alloyed case hardened steels	24-30 Rc >30-38 Rc	395 280	•	•	•	•	•	•	•	•	•	•	•	•	•
Nitriding steels	≥24-30 Rc >30-38 Rc	350 330	•	•	•	•	•	•	•	•	•	•	•	•	•
Tool steels	≤24 Rc >24-30 Rc	240 180	•	•	•	•	•	•	•	•	•	•	•	•	•
High speed steels	≥14-30 Rc	195	•	•	•	•	•	•	•	•	•	•	•	•	•
Spring steels	≤330 Bhn	195	•	•	•	•	•	•	•	•	•	•	•	•	•
Stainless steels, sulphured austenitic martensitic	≤24 Rc 180 ≤24 Rc	195 180 165	•	•	•	•	•	•	•	•	•	•	•	•	•
Hardened steels	≤40-48 Rc >48-60 Rc	180 115	•	•	•	•	•	•	•	•	•	•	•	•	•
Special alloys	≤38 Rc	115	•	•	•	•	•	•	•	•	•	•	•	•	•
Cast iron	≤240 Bhn <300 Bhn	690 525	•	•	•	•	•	•	•	•	•	•	•	•	•
Spheroidal graphite iron and malleable cast iron	≤240 Bhn <300 Bhn	450 425	•	•	•	•	•	•	•	•	•	•	•	•	•
Chilled cast iron	≤350 Bhn	130	•	•	•	•	•	•	•	•	•	•	•	•	•
Ti and Ti-alloys	≤24 Rc >24-38 Rc	150 130	•	•	•	•	•	•	•	•	•	•	•	•	•
Aluminium and Al-alloys	≤120 Bhn	1015	•	•	•	•	•	•	•	•	•	•	•	•	•
Al wrought alloys	≤150 Bhn	1015	•	•	•	•	•	•	•	•	•	•	•	•	•
Al cast alloys ≤ 10 % Si > 10 % Si	≤200 Bhn ≤200 Bhn	855 720	•	•	•	•	•	•	•	•	•	•	•	•	•
Magnesium alloys	≤150 Bhn	920	•	•	•	•	•	•	•	•	•	•	•	•	•
Copper, low-alloyed	≤120 Bhn	410	•	•	•	•	•	•	•	•	•	•	•	•	•
Brass, short-chipping long-chipping	≤200 Bhn ≤200 Bhn	1065 720	•	•	•	•	•	•	•	•	•	•	•	•	•
Bronze, short-chipping	≤200 Bhn >200-260 Bhn	410 345	•	•	•	•	•	•	•	•	•	•	•	•	•
Bronze, long-chipping	≤24 Rc >24-30 Rc	295 260	•	•	•	•	•	•	•	•	•	•	•	•	•
Duroplastics	-	•	•	•	•	•	•	•	•	•	•	•	•	•	•
Thermoplastics	-	•	•	•	•	•	•	•	•	•	•	•	•	•	•
Reinforced plastics - Kevlar	-	•	•	•	•	•	•	•	•	•	•	•	•	•	•
Reinforced plastics - GFK / CFK	-	•	•	•	•	•	•	•	•	•	•	•	•	•	•

Using These Tables. The Speeds & Feeds listed below are conservative recommendations for initial setup. In actual use, depending on the machining environment and workpiece material, significantly higher speeds and feeds may be achievable. Using the below as a starting point, cutting speed/feed can be gradually adjusted upwards until the optimum settings per application are found.

Questions? Contact us by telephone at (800) 776-6170.

Series # 2485 / # 5242 (3xD body)

Material group	Hardness	SFM	Feed Rate - IPR					
			≤16.000 mm	41/64 - 25/32 in. 16.001 - 20.000 mm	51/64 - 31/32 in. 20.001 - 25.000 mm	63/64 - 1 17/64 in. 25.001 - 31.500 mm	1 1/4 - 1 9/16 in. 31.501 - 40.000 mm	1 37/64 - 1 61/64 in. 40.001 - 50.000 mm
Common structural steels	≤100 Bhn	430	0.0100	0.0125	0.0160	0.0200	0.0250	0.0250
	>100-260 Bhn	365	0.0080	0.0100	0.0125	0.0125	0.0160	0.0200
Free-cutting steels	≤24 Rc	430	0.0125	0.0160	0.0200	0.0200	0.0250	0.0315
	>24-30 Rc	365	0.0100	0.0125	0.0160	0.0160	0.0200	0.0250
Unalloyed heat-treatable steels	≤16 Rc	430	0.0100	0.0125	0.0160	0.0160	0.0200	0.0250
	16-24 Rc	410	0.0100	0.0125	0.0160	0.0160	0.0200	0.0250
	24-30 Rc	365	0.0080	0.0100	0.0125	0.0125	0.0160	0.0200
Alloyed heat-treatable steels	24-30 Rc	365	0.0100	0.0125	0.0160	0.0160	0.0200	0.0250
	>30-38 Rc	300	0.0080	0.0100	0.0125	0.0125	0.0160	0.0200
Unalloyed case hardened steels	≤230 Bhn	430	0.0125	0.0160	0.0200	0.0200	0.0250	0.0315
Alloyed case hardened steels	24-30 Rc	365	0.0100	0.0125	0.0160	0.0160	0.0200	0.0250
	>30-38 Rc	230	0.0065	0.0080	0.0100	0.0100	0.0125	0.0160
Nitriding steels	≥24-30 Rc	345	0.0080	0.0100	0.0125	0.0125	0.0160	0.0200
	>30-38 Rc	230	0.0065	0.0080	0.0100	0.0100	0.0125	0.0160
Tool steels	≤24 Rc	185	0.0080	0.0100	0.0125	0.0125	0.0160	0.0200
	>24-30 Rc	165	0.0065	0.0080	0.0100	0.0100	0.0125	0.0160
High speed steels	≥14-30 Rc	185	0.0050	0.0065	0.0080	0.0080	0.0100	0.0125
Spring steels	≤330 Bhn	165	0.0040	0.0050	0.0065	0.0065	0.0080	0.0100
Stainless steels, sulphured austenitic martensitic	≤24 Rc	185	0.0050	0.0065	0.0080	0.0080	0.0100	0.0125
	≤24 Rc	135	0.0050	0.0065	0.0080	0.0080	0.0100	0.0125
	≤24 Rc	115	0.0050	0.0065	0.0080	0.0080	0.0100	0.0125
Hardened steels	≤40-48 Rc	85	0.0040	0.0050	0.0065	0.0065	0.0080	0.0100
	>48-60 Rc	*	*	*	*	*	*	*
Special alloys	≤38 Rc	85	0.0040	0.0050	0.0065	0.0065	0.0080	0.0100
Cast iron	≤240 Bhn	685	0.0125	0.0160	0.0200	0.0200	0.0250	0.0315
	<300 Bhn	505	0.0125	0.0160	0.0200	0.0200	0.0250	0.0315
Spheroidal graphite iron and malleable cast iron	≤240 Bhn	505	0.0125	0.0160	0.0200	0.0200	0.0250	0.0315
	<300 Bhn	425	0.0100	0.0125	0.0160	0.0160	0.0200	0.0250
Chilled cast iron	≤350 Bhn	115	0.0040	0.0050	0.0065	0.0065	0.0080	0.0100
Ti and Ti-alloys	≤24 Rc	135	0.0050	0.0065	0.0080	0.0080	0.0100	0.0125
	>24-38 Rc	115	0.0040	0.0050	0.0065	0.0065	0.0080	0.0100
Aluminium and Al-alloys	≤120 Bhn	955	0.0125	0.0160	0.0200	0.0200	0.0250	0.0315
Al wrought alloys	≤150 Bhn	855	0.0125	0.0160	0.0200	0.0200	0.0250	0.0315
Al cast alloys ≤ 10 % Si	≤200 Bhn	770	0.0125	0.0160	0.0200	0.0200	0.0250	0.0315
	> 10 % Si	≤200 Bhn	635	0.0125	0.0160	0.0200	0.0200	0.0250
Magnesium alloys	≤150 Bhn	850	0.0125	0.0160	0.0200	0.0200	0.0250	0.0315
Copper, low-alloyed	≤120 Bhn	340	0.0100	0.0125	0.0160	0.0160	0.0200	0.0250
Brass, short-chipping long-chipping	≤200 Bhn	885	0.0125	0.0160	0.0200	0.0200	0.0250	0.0315
	≤200 Bhn	590	0.0100	0.0125	0.0160	0.0160	0.0200	0.0250
Bronze, short-chipping	≤200 Bhn	340	0.0100	0.0125	0.0160	0.0160	0.0200	0.0250
	>200-260 Bhn	275	0.0100	0.0125	0.0160	0.0160	0.0200	0.0250
Bronze, long-chipping	≤24 Rc	210	0.0100	0.0125	0.0160	0.0160	0.0200	0.0250
	>24-30 Rc	180	0.0080	0.0100	0.0125	0.0125	0.0160	0.0200
Duroplastics	-	340	0.0080	0.0100	0.0125	0.0125	0.0160	0.0200
Thermoplastics	-	340	0.0080	0.0100	0.0125	0.0125	0.0160	0.0200
Reinforced plastics - Kevlar	-	340	0.0080	0.0100	0.0125	0.0125	0.0160	0.0200
Reinforced plastics - GFK / CFK	-	340	0.0080	0.0100	0.0125	0.0125	0.0160	0.0200

Series # 2485 / # 5243 (5xD body)

Material group	Hardness	SFM	Feed Rate - IPR					
			≤16.000 mm	41/64 - 25/32 in. 16.001 - 20.000 mm	51/64 - 31/32 in. 20.001 - 25.000 mm	63/64 - 1 17/64 in. 25.001 - 31.500 mm	1 1/4 - 1 9/16 in. 31.501 - 40.000 mm	1 37/64 - 1 61/64 in. 40.001 - 50.000 mm
Common structural steels	≤100 Bhn	410	0.0100	0.0125	0.0160	0.0160	0.0200	0.0250
	>100-260 Bhn	345	0.0080	0.0100	0.0125	0.0125	0.0160	0.0200
Free-cutting steels	≤24 Rc	410	0.0125	0.0160	0.0200	0.0200	0.0250	0.0315
	>24-30 Rc	345	0.0100	0.0125	0.0160	0.0160	0.0200	0.0250
Unalloyed heat-treatable steels	≤16 Rc	410	0.0100	0.0125	0.0160	0.0160	0.0200	0.0250
	16-24 Rc	395	0.0100	0.0125	0.0160	0.0160	0.0200	0.0250
	24-30 Rc	345	0.0080	0.0100	0.0125	0.0125	0.0160	0.0200
Alloyed heat-treatable steels	24-30 Rc	345	0.0100	0.0125	0.0160	0.0160	0.0200	0.0250
	>30-38 Rc	280	0.0080	0.0100	0.0125	0.0125	0.0160	0.0200
Unalloyed case hardened steels	≤230 Bhn	410	0.0125	0.0160	0.0200	0.0200	0.0250	0.0315
Alloyed case hardened steels	24-30 Rc	345	0.0100	0.0125	0.0160	0.0160	0.0200	0.0250
	>30-38 Rc	230	0.0065	0.0080	0.0100	0.0100	0.0125	0.0160
Nitriding steels	≥24-30 Rc	345	0.0080	0.0100	0.0125	0.0125	0.0160	0.0200
	>30-38 Rc	230	0.0065	0.0080	0.0100	0.0100	0.0125	0.0160
Tool steels	≤24 Rc	185	0.0080	0.0100	0.0125	0.0125	0.0160	0.0200
	>24-30 Rc	165	0.0065	0.0080	0.0100	0.0100	0.0125	0.0160
High speed steels	≥14-30 Rc	185	0.0050	0.0065	0.0080	0.0080	0.0100	0.0125
Spring steels	≤330 Bhn	165	0.0040	0.0050	0.0065	0.0065	0.0080	0.0100
Stainless steels, sulphured austenitic martensitic	≤24 Rc	185	0.0050	0.0065	0.0080	0.0080	0.0100	0.0125
	≤24 Rc	135	0.0050	0.0065	0.0080	0.0080	0.0100	0.0125
	≤24 Rc	115	0.0050	0.0065	0.0080	0.0080	0.0100	0.0125
Hardened steels	≤40-48 Rc	85	0.0040	0.0050	0.0065	0.0065	0.0080	0.0100
	>48-60 Rc	*	*	*	*	*	*	*
Special alloys	≤38 Rc	85	0.0040	0.0050	0.0065	0.0065	0.0080	0.0100
Cast iron	≤240 Bhn	635	0.0125	0.0160	0.0200	0.0200	0.0250	0.0315
	<300 Bhn	475	0.0125	0.0160	0.0200	0.0200	0.0250	0.0315
Spheroidal graphite iron and malleable cast iron	≤240 Bhn	475	0.0125	0.0160	0.0200	0.0200	0.0250	0.0315
	<300 Bhn	390	0.0100	0.0125	0.0160	0.0160	0.0200	0.0250
Chilled cast iron	≤350 Bhn	115	0.0040	0.0050	0.0065	0.0065	0.0080	0.0100
Ti and Ti-alloys	≤24 Rc	135	0.0050	0.0065	0.0080	0.0080	0.0100	0.0125
	>24-38 Rc	115	0.0040	0.0050	0.0065	0.0065	0.0080	0.0100
Aluminium and Al-alloys	≤120 Bhn	855	0.0125	0.0160	0.0200	0.0200	0.0250	0.0315
Al wrought alloys	≤150 Bhn	855	0.0125	0.0160	0.0200	0.0200	0.0250	0.0315
Al cast alloys ≤ 10 % Si	≤200 Bhn	720	0.0125	0.0160	0.0200	0.0200	0.0250	0.0315
	> 10 % Si	≤200 Bhn	590	0.0125	0.0160	0.0200	0.0200	0.0250
Magnesium alloys	≤150 Bhn	850	0.0125	0.0160	0.0200	0.0200	0.0250	0.0315
Copper, low-alloyed	≤120 Bhn	340	0.0100	0.0125	0.0160	0.0160	0.0200	0.0250
Brass, short-chipping long-chipping	≤200 Bhn	885	0.0125	0.0160	0.0200	0.0200	0.0250	0.0315
	≤200 Bhn	590	0.0100	0.0125	0.0160	0.0160	0.0200	0.0250
Bronze, short-chipping	≤200 Bhn	340	0.0100	0.0125	0.0160	0.0160	0.0200	0.0250
	>200-260 Bhn	275	0.0100	0.0125	0.0160	0.0160	0.0200	0.0250
Bronze, long-chipping	≤24 Rc	210	0.0100	0.0125	0.0160	0.0160	0.0200	0.0250
	>24-30 Rc	180	0.0080	0.0100	0.0125	0.0125	0.0160	0.0200
Duroplastics	-	340	0.0080	0.0100	0.0125	0.0125	0.0160	0.0200
Thermoplastics	-	340	0.0080	0.0100	0.0125	0.0125	0.0160	0.0200
Reinforced plastics - Kevlar	-	340	0.0080	0.0100	0.0125	0.0125	0.0160	0.0200
Reinforced plastics - GFK / CFK	-	340	0.0080	0.0100	0.0125	0.0125	0.0160	0.0200

RPM = $\frac{SFM}{DIAM. in.} \times 3.82$ IPM = IPR x RPM

HOLE DEPTH in. x 60 = Cut Time
IPM

mm = in. x 25.40

m/min. = SFM ÷ 3.28
mm/rev. = IPR x 25.40

Bar = PSI ÷ 14.50
Liter = Gal. ÷ 3.79

Series # 2485 / # 5248 (7xD body)

Material group	Hardness	SFM	Feed Rate - IPR						
			≤16.000 mm	41/64 - 25/32 in. 16.001 - 20.000 mm	451/64 - 31/32 in. 20.001 - 25.000 mm	63/64 - 1 17/64 in. 25.001 - 31.500 mm	1 1/4 - 1 9/16 in. 31.501 - 40.000 mm	1 37/64 - 1 61/64 in. 40.001 - 50.000 mm	
Common structural steels	≤100 Bhn	395	0.0080	0.0100	0.0125	0.0125	0.0160	0.0200	
	>100-260 Bhn	345	0.0065	0.0080	0.0100	0.0100	0.0125	0.0160	
Free-cutting steels	≤24 Rc	395	0.0100	0.0125	0.0160	0.0160	0.0200	0.0250	
	>24-30 Rc	345	0.0080	0.0100	0.0125	0.0125	0.0160	0.0200	
Unalloyed heat-treatable steels	≤16 Rc	395	0.0080	0.0100	0.0125	0.0125	0.0160	0.0200	
	16-24 Rc	365	0.0080	0.0100	0.0125	0.0125	0.0160	0.0200	
	24-30 Rc	330	0.0065	0.0080	0.0100	0.0100	0.0125	0.0160	
Alloyed heat-treatable steels	24-30 Rc	330	0.0080	0.0100	0.0125	0.0125	0.0160	0.0200	
	>30-38 Rc	280	0.0065	0.0080	0.0100	0.0100	0.0125	0.0160	
Unalloyed case hardened steels	≤230 Bhn	395	0.0100	0.0125	0.0160	0.0160	0.0200	0.0250	
Alloyed case hardened steels	24-30 Rc	330	0.0080	0.0100	0.0125	0.0125	0.0160	0.0200	
	>30-38 Rc	230	0.0065	0.0080	0.0100	0.0100	0.0125	0.0160	
Nitriding steels	≥24-30 Rc	345	0.0065	0.0080	0.0100	0.0100	0.0125	0.0160	
	>30-38 Rc	230	0.0050	0.0065	0.0080	0.0080	0.0100	0.0125	
Tool steels	≤24 Rc	185	0.0065	0.0080	0.0100	0.0100	0.0125	0.0160	
	>24-30 Rc	165	0.0050	0.0065	0.0080	0.0080	0.0100	0.0125	
High speed steels	≥14-30 Rc	185	0.0040	0.0050	0.0065	0.0065	0.0080	0.0100	
Spring steels	≤330 Bhn	165	0.0040	0.0050	0.0065	0.0065	0.0080	0.0100	
Stainless steels, sulphured	≤24 Rc	185	0.0040	0.0050	0.0065	0.0065	0.0080	0.0100	
	austenitic	135	0.0040	0.0050	0.0065	0.0065	0.0080	0.0100	
	martensitic	115	0.0040	0.0050	0.0065	0.0065	0.0080	0.0100	
Hardened steels	≤40-48 Rc	85	0.0035	0.0040	0.0050	0.0065	0.0065	0.0080	
	>48-60 Rc	*	*	*	*	*	*	*	
Special alloys	≤38 Rc	85	0.0035	0.0040	0.0050	0.0065	0.0065	0.0080	
Cast iron	≤240 Bhn	635	0.0100	0.0125	0.0160	0.0160	0.0200	0.0250	
	<300 Bhn	475	0.0100	0.0125	0.0160	0.0160	0.0200	0.0250	
Spheroidal graphite iron and malleable cast iron	≤240 Bhn	475	0.0100	0.0125	0.0160	0.0160	0.0200	0.0250	
	<300 Bhn	390	0.0080	0.0100	0.0125	0.0125	0.0160	0.0200	
Chilled cast iron	≤350 Bhn	115	0.0040	0.0050	0.0065	0.0065	0.0080	0.0100	
Ti and Ti-alloys	≤24 Rc	135	0.0040	0.0050	0.0065	0.0065	0.0080	0.0100	
	>24-38 Rc	115	0.0035	0.0040	0.0050	0.0065	0.0065	0.0080	
Aluminium and Al-alloys	≤120 Bhn	855	0.0100	0.0125	0.0160	0.0160	0.0200	0.0250	
Al wrought alloys	≤150 Bhn	855	0.0100	0.0125	0.0160	0.0160	0.0200	0.0250	
Al cast alloys ≤ 10 % Si	≤200 Bhn	720	0.0100	0.0125	0.0160	0.0160	0.0200	0.0250	
	> 10 % Si	≤200 Bhn	590	0.0100	0.0125	0.0160	0.0160	0.0200	0.0250
Magnesium alloys	≤150 Bhn	850	0.0100	0.0125	0.0160	0.0160	0.0200	0.0250	
Copper, low-alloyed	≤120 Bhn	340	0.0080	0.0100	0.0125	0.0125	0.0160	0.0200	
Brass, short-chipping	≤200 Bhn	885	0.0100	0.0125	0.0160	0.0160	0.0200	0.0250	
	long-chipping	≤200 Bhn	590	0.0080	0.0100	0.0125	0.0125	0.0160	0.0200
Bronze, short-chipping	≤200 Bhn	340	0.0080	0.0100	0.0125	0.0125	0.0160	0.0200	
	>200-260 Bhn	275	0.0080	0.0100	0.0125	0.0125	0.0160	0.0200	
Bronze, long-chipping	≤24 Rc	210	0.0080	0.0100	0.0125	0.0125	0.0160	0.0200	
	>24-30 Rc	180	0.0065	0.0080	0.0100	0.0100	0.0125	0.0160	
Duroplastics	-	340	0.0065	0.0080	0.0100	0.0100	0.0125	0.0160	
Thermoplastics	-	340	0.0065	0.0080	0.0100	0.0100	0.0125	0.0160	
Reinforced plastics - Kevlar	-	340	0.0065	0.0080	0.0100	0.0100	0.0125	0.0160	
Reinforced plastics - GFK / CFK	-	340	0.0065	0.0080	0.0100	0.0100	0.0125	0.0160	

Note: When drilling from solid with #5248 holder, spot drilling (>140° point angle to a depth of at least 2/3 insert diameter) is recommended.

Series # 2601

Material group	Hardness	SFM	Feed Rate - IPR										
			1/16 in. 1.590 mm	1/8 in. 3.170 mm	1/4 in. 6.350 mm	3/8 in. 9.520 mm	1/2 in. 12.700 mm	5/8 in. 15.870 mm	3/4 in. 19.050 mm	1 in. 25.400 mm	1 1/4 in. 31.750 mm	1 1/2 in. 38.100 mm	
Common structural steels	≤100 Bhn	*	*	*	*	*	*	*	*	*	*	*	*
	>100-260 Bhn	*	*	*	*	*	*	*	*	*	*	*	*
Free-cutting steels	≤24 Rc	*	*	*	*	*	*	*	*	*	*	*	*
	>24-30 Rc	185	*	0.0040	0.0065	0.0080	0.0100	*	*	*	*	*	*
Unalloyed heat-treatable steels	≤16 Rc	*	*	*	*	*	*	*	*	*	*	*	*
	16-24 Rc	185	*	0.0040	0.0065	0.0080	0.0100	*	*	*	*	*	*
	24-30 Rc	100	*	0.0030	0.0050	0.0065	0.0080	*	*	*	*	*	*
Alloyed heat-treatable steels	24-30 Rc	120	*	0.0030	0.0050	0.0065	0.0080	*	*	*	*	*	*
	>30-38 Rc	90	*	0.0025	0.0040	0.0050	0.0065	*	*	*	*	*	*
Unalloyed case hardened steels	≤230 Bhn	*	*	*	*	*	*	*	*	*	*	*	*
Alloyed case hardened steels	24-30 Rc	105	*	0.0030	0.0050	0.0065	0.0080	*	*	*	*	*	*
	>30-38 Rc	80	*	0.0025	0.0040	0.0050	0.0065	*	*	*	*	*	*
Nitriding steels	≥24-30 Rc	90	*	0.0030	0.0050	0.0065	0.0080	*	*	*	*	*	*
	>30-38 Rc	65	*	0.0025	0.0040	0.0050	0.0065	*	*	*	*	*	*
Tool steels	≤24 Rc	120	*	0.0030	0.0050	0.0065	0.0080	*	*	*	*	*	*
	>24-30 Rc	65	*	0.0025	0.0040	0.0050	0.0065	*	*	*	*	*	*
High speed steels	≥14-30 Rc	65	*	0.0025	0.0040	0.0050	0.0065	*	*	*	*	*	*
Spring steels	≤330 Bhn	*	*	*	*	*	*	*	*	*	*	*	*
Stainless steels, sulphured	≤24 Rc	90	*	0.0030	0.0050	0.0065	0.0080	*	*	*	*	*	*
	austenitic	*	*	*	*	*	*	*	*	*	*	*	*
	martensitic	80	*	0.0025	0.0040	0.0050	0.0065	*	*	*	*	*	*
Hardened steels	≤40-48 Rc	*	*	*	*	*	*	*	*	*	*	*	*
	>48-60 Rc	*	*	*	*	*	*	*	*	*	*	*	*
Special alloys	≤38 Rc	*	*	*	*	*	*	*	*	*	*	*	*
Cast iron	≤240 Bhn	235	*	0.0050	0.0080	0.0100	0.0125	*	*	*	*	*	*
	<300 Bhn	185	*	0.0050	0.0080	0.0100	0.0125	*	*	*	*	*	*
Spheroidal graphite iron and malleable cast iron	≤240 Bhn	200	*	0.0050	0.0080	0.0100	0.0125	*	*	*	*	*	*
	<300 Bhn	145	*	0.0050	0.0080	0.0100	0.0125	*	*	*	*	*	*
Chilled cast iron	≤350 Bhn	50	*	0.0025	0.0040	0.0050	0.0065	*	*	*	*	*	*
Ti and Ti-alloys	≤24 Rc	*	*	*	*	*	*	*	*	*	*	*	*
	>24-38 Rc	*	*	*	*	*	*	*	*	*	*	*	*
Aluminium and Al-alloys	≤120 Bhn	*	*	*	*	*	*	*	*	*	*	*	*
Al wrought alloys	≤150 Bhn	*	*	*	*	*	*	*	*	*	*	*	*
Al cast alloys ≤ 10 % Si	≤200 Bhn	460	*	0.0065	0.0100	0.0125	0.0160	*	*	*	*	*	*
	> 10 % Si	≤200 Bhn	360	*	0.0040	0.0065	0.0080	0.0100	*	*	*	*	*
Magnesium alloys	≤150 Bhn	*	*	*	*	*	*	*	*	*	*	*	*
Copper, low-alloyed	≤120 Bhn	235	*	0.0040	0.0065	0.0080	0.0100	*	*	*	*	*	*
Brass, short-chipping	≤200 Bhn	*	*	*	*	*	*	*	*	*	*	*	*
	long-chipping	≤200 Bhn	295	*	0.0040	0.0065	0.0080	0.0100	*	*	*	*	*
Bronze, short-chipping	≤200 Bhn	*	*	*	*	*	*	*	*	*	*	*	*
	>200-260 Bhn	*	*	*	*	*	*	*	*	*	*	*	*
Bronze, long-chipping	≤24 Rc	185	*	0.0030	0.0050	0.0065	0.0080	*	*	*	*	*	*
	>24-30 Rc	145	*	0.0030	0.0050	0.0065	0.0080	*	*	*	*	*	*
Duroplastics	-	120	*	0.0030	0.0050	0.0065	0.0080	*	*	*	*	*	*
Thermoplastics	-	*	*	*	*	*	*	*	*	*	*	*	*
Reinforced plastics - Kevlar	-	*	*	*	*	*	*	*	*	*	*	*	*
Reinforced plastics - GFK / CFK	-	*	*	*	*	*	*	*	*	*	*	*	*

Series # 2602

Material group	Hardness	SFM	Feed Rate - IPR											
			1/16 in. 1.590 mm	1/8 in. 3.170 mm	1/4 in. 6.350 mm	3/8 in. 9.520 mm	1/2 in. 12.700 mm	5/8 in. 15.870 mm	3/4 in. 19.050 mm	1 in. 25.400 mm	1 1/4 in. 31.750 mm	1 1/2 in. 38.100 mm		
Common structural steels	≤100 Bhn >100-260 Bhn	• •	• •	• •	• •	• •	• •	• •	• •	• •	• •	• •	• •	• •
Free-cutting steels	≤24 Rc >24-30 Rc	• 235	• •	• 0.0040	• 0.0065	• 0.0080	• 0.0100	• •	• •	• •	• •	• •	• •	• •
Unalloyed heat-treatable steels	≤16 Rc 16-24 Rc 24-30 Rc	• 210 120	• • •	• 0.0040 0.0030	• 0.0065 0.0050	• 0.0080 0.0065	• 0.0100 0.0080	• • •	• • •	• • •	• • •	• • •	• • •	• • •
Alloyed heat-treatable steels	24-30 Rc >30-38 Rc	145 120	• •	• 0.0030 0.0025	• 0.0050 0.0040	• 0.0065 0.0050	• 0.0080 0.0065	• • •	• • •	• • •	• • •	• • •	• • •	• • •
Unalloyed case hardened steels	≤230 Bhn	•	•	•	•	•	•	•	•	•	•	•	•	•
Alloyed case hardened steels	24-30 Rc >30-38 Rc	130 100	• •	• 0.0030 0.0025	• 0.0050 0.0040	• 0.0065 0.0050	• 0.0080 0.0065	• • •	• • •	• • •	• • •	• • •	• • •	• • •
Nitriding steels	≥24-30 Rc >30-38 Rc	120 85	• •	• 0.0030 0.0025	• 0.0050 0.0040	• 0.0065 0.0050	• 0.0080 0.0065	• • •	• • •	• • •	• • •	• • •	• • •	• • •
Tool steels	≤24 Rc >24-30 Rc	145 85	• •	• 0.0030 0.0025	• 0.0050 0.0040	• 0.0065 0.0050	• 0.0080 0.0065	• • •	• • •	• • •	• • •	• • •	• • •	• • •
High speed steels	≥14-30 Rc	85	•	•	•	•	•	•	•	•	•	•	•	•
Spring steels	≤330 Bhn	•	•	•	•	•	•	•	•	•	•	•	•	•
Stainless steels, sulphured austenitic	≤24 Rc	120	•	•	•	•	•	•	•	•	•	•	•	•
Stainless steels, sulphured martensitic	≤24 Rc	100	•	•	•	•	•	•	•	•	•	•	•	•
Hardened steels	≤40-48 Rc >48-60 Rc	• •	• •	• •	• •	• •	• •	• •	• •	• •	• •	• •	• •	• •
Special alloys	≤38 Rc	•	•	•	•	•	•	•	•	•	•	•	•	•
Cast iron	≤240 Bhn >300 Bhn	295 235	• •	• 0.0050 0.0050	• 0.0080 0.0080	• 0.0100 0.0100	• 0.0125 0.0125	• • •	• • •	• • •	• • •	• • •	• • •	• • •
Spheroidal graphite iron and malleable cast iron	≤240 Bhn >300 Bhn	260 185	• •	• 0.0050 0.0050	• 0.0080 0.0080	• 0.0100 0.0100	• 0.0125 0.0125	• • •	• • •	• • •	• • •	• • •	• • •	• • •
Chilled cast iron	≤350 Bhn	60	•	•	•	•	•	•	•	•	•	•	•	•
Ti and Ti-alloys	≤24 Rc >24-38 Rc	• •	• •	• •	• •	• •	• •	• •	• •	• •	• •	• •	• •	• •
Aluminium and Al-alloys	≤120 Bhn	•	•	•	•	•	•	•	•	•	•	•	•	•
Al wrought alloys	≤150 Bhn	•	•	•	•	•	•	•	•	•	•	•	•	•
Al cast alloys ≤ 10 % Si	≤200 Bhn	560	•	•	•	•	•	•	•	•	•	•	•	•
Al cast alloys > 10 % Si	≤200 Bhn	460	•	•	•	•	•	•	•	•	•	•	•	•
Magnesium alloys	≤150 Bhn	•	•	•	•	•	•	•	•	•	•	•	•	•
Copper, low-alloyed	≤120 Bhn	295	•	•	•	•	•	•	•	•	•	•	•	•
Brass, short-chipping long-chipping	≤200 Bhn ≤200 Bhn	• 340	• •	• 0.0065 0.0065	• 0.0080 0.0080	• 0.0100 0.0100	• 0.0100 0.0100	• • •	• • •	• • •	• • •	• • •	• • •	• • •
Bronze, short-chipping	≤200 Bhn >200-260 Bhn	• •	• •	• •	• •	• •	• •	• •	• •	• •	• •	• •	• •	• •
Bronze, long-chipping	≤24 Rc >24-30 Rc	235 185	• •	• 0.0030 0.0030	• 0.0050 0.0050	• 0.0065 0.0065	• 0.0080 0.0080	• • •	• • •	• • •	• • •	• • •	• • •	• • •
Duroplastics	-	145	•	•	•	•	•	•	•	•	•	•	•	•
Thermoplastics	-	•	•	•	•	•	•	•	•	•	•	•	•	•
Reinforced plastics - Kevlar	-	•	•	•	•	•	•	•	•	•	•	•	•	•
Reinforced plastics - GFK / CFK	-	•	•	•	•	•	•	•	•	•	•	•	•	•

Series # 2747 / # 5242 (3xD body)

Material group	Hardness	SFM	Feed Rate - IPR								
			≤16.000 mm	41/64 - 25/32 in. 16.001 - 20.000 mm	51/64 - 31/32 in. 20.001 - 25.000 mm	63/64 - 1 17/64 in. 25.001 - 31.500 mm	1 1/4 - 1 9/16 in. 31.501 - 40.000 mm	1 37/64 - 1 61/64 in. 40.001 - 50.000 mm			
Common structural steels	≤100 Bhn >100-260 Bhn	• •	• •	• •	• •	• •	• •	• •	• •	• •	• •
Free-cutting steels	≤24 Rc >24-30 Rc	• 235	• •	• •	• •	• •	• •	• •	• •	• •	• •
Unalloyed heat-treatable steels	≤16 Rc 16-24 Rc 24-30 Rc	• • •	• • •	• • •	• • •	• • •	• • •	• • •	• • •	• • •	• • •
Alloyed heat-treatable steels	24-30 Rc >30-38 Rc	• •	• •	• •	• •	• •	• •	• •	• •	• •	• •
Unalloyed case hardened steels	≤230 Bhn	•	•	•	•	•	•	•	•	•	•
Alloyed case hardened steels	24-30 Rc >30-38 Rc	• •	• •	• •	• •	• •	• •	• •	• •	• •	• •
Nitriding steels	≥24-30 Rc >30-38 Rc	• •	• •	• •	• •	• •	• •	• •	• •	• •	• •
Tool steels	≤24 Rc >24-30 Rc	• •	• •	• •	• •	• •	• •	• •	• •	• •	• •
High speed steels	≥14-30 Rc	•	•	•	•	•	•	•	•	•	•
Spring steels	≤330 Bhn	•	•	•	•	•	•	•	•	•	•
Stainless steels, sulphured austenitic	≤24 Rc	•	•	•	•	•	•	•	•	•	•
Stainless steels, sulphured martensitic	≤24 Rc	•	•	•	•	•	•	•	•	•	•
Hardened steels	≤40-48 Rc >48-60 Rc	• •	• •	• •	• •	• •	• •	• •	• •	• •	• •
Special alloys	≤38 Rc	•	•	•	•	•	•	•	•	•	•
Cast iron	≤240 Bhn >300 Bhn	325 260	0.0125 0.0125	0.0160 0.0160	0.0200 0.0200	0.0200 0.0200	0.0250 0.0250	0.0315 0.0315	0.0315 0.0315	0.0315 0.0315	0.0315 0.0315
Spheroidal graphite iron and malleable cast iron	≤240 Bhn >300 Bhn	260 230	0.0125 0.0100	0.0160 0.0125	0.0200 0.0160	0.0200 0.0160	0.0250 0.0200	0.0315 0.0250	0.0315 0.0250	0.0315 0.0250	0.0315 0.0250
Chilled cast iron	≤350 Bhn	35	0.0040	0.0050	0.0065	0.0065	0.0080	0.0100	0.0100	0.0100	0.0100
Ti and Ti-alloys	≤24 Rc >24-38 Rc	• •	• •	• •	• •	• •	• •	• •	• •	• •	• •
Aluminium and Al-alloys	≤120 Bhn	660	0.0125	0.0160	0.0200	0.0200	0.0250	0.0315	0.0315	0.0315	0.0315
Al wrought alloys	≤150 Bhn	595	0.0125	0.0160	0.0200	0.0200	0.0250	0.0315	0.0315	0.0315	0.0315
Al cast alloys ≤ 10 % Si	≤200 Bhn	490	0.0125	0.0160	0.0200	0.0200	0.0250	0.0315	0.0315	0.0315	0.0315
Al cast alloys > 10 % Si	≤200 Bhn	390	0.0125	0.0160	0.0200	0.0200	0.0250	0.0315	0.0315	0.0315	0.0315
Magnesium alloys	≤150 Bhn	590	0.0125	0.0160	0.0200	0.0200	0.0250	0.0315	0.0315	0.0315	0.0315
Copper, low-alloyed	≤120 Bhn	225	0.0100	0.0125	0.0160	0.0160	0.0200	0.0250	0.0250	0.0250	0.0250
Brass, short-chipping long-chipping	≤200 Bhn ≤200 Bhn	585 390	0.0125 0.0100	0.0160 0.0125	0.0200 0.0160	0.0200 0.0160	0.0250 0.0200	0.0315 0.0250	0.0315 0.0250	0.0315 0.0250	0.0315 0.0250
Bronze, short-chipping	≤200 Bhn >200-260 Bhn	230 160	0.0100 0.0100	0.0125 0.0125	0.0160 0.0160	0.0160 0.0160	0.0200 0.0200	0.0250 0.0250	0.0250 0.0250	0.0250 0.0250	0.0250 0.0250
Bronze, long-chipping	≤24 Rc >24-30 Rc	145 115	0.0100 0.0080	0.0125 0.0100	0.0160 0.0125	0.0160 0.0125	0.0200 0.0160	0.0250 0.0200	0.0250 0.0200	0.0250 0.0200	0.0250 0.0200
Duroplastics	-	165	0.0080	0.0100	0.0125	0.0125	0.0160	0.0200	0.0200	0.0200	0.0200
Thermoplastics	-	165	0.0080	0.0100	0.0125	0.0125	0.0160	0.0200	0.0200	0.0200	0.0200
Reinforced plastics - Kevlar	-	165	0.0080	0.0100	0.0125	0.0125	0.0160	0.0200	0.0200	0.0200	0.0200
Reinforced plastics - GFK / CFK	-	165	0.0080	0.0100	0.0125	0.0125	0.0160	0.0200	0.0200	0.0200	0.0200

$$\text{RPM} = \frac{\text{SFM}}{\text{DIAM. in.}} \times 3.82 \quad \text{IPM} = \text{IPR} \times \text{RPM}$$

$$\frac{\text{HOLE DEPTH in.}}{\text{IPM}} \times 60 = \text{Cut Time} \quad \text{mm} = \text{in.} \times 25.40$$

$$\text{m/min.} = \text{SFM} \div 3.28 \quad \text{mm/rev.} = \text{IPR} \times 25.40$$

$$\text{Bar} = \text{PSI} \div 14.50 \quad \text{Liter} = \text{Gal.} \div 3.79$$

Series # 2747 / # 5243 (5xD body)

Material group	Hardness	SFM	Feed Rate - IPR					
			≤16.000 mm	41/64 - 25/32 in. 16.001 - 20.000 mm	51/64 - 31/32 in. 20.001 - 25.000 mm	63/64 - 1 17/64 in. 25.001 - 31.500 mm	1 1/4 - 1 9/16 in. 31.501 - 40.000 mm	1 37/64 - 1 61/64 in. 40.001 - 50.000 mm
Common structural steels	≤100 Bhn >100-260 Bhn	• •	• •	• •	• •	• •	• •	• •
Free-cutting steels	≤24 Rc >24-30 Rc	• •	• •	• •	• •	• •	• •	• •
Unalloyed heat-treatable steels	≤16 Rc 16-24 Rc 24-30 Rc	• • •	• • •	• • •	• • •	• • •	• • •	• • •
Alloyed heat-treatable steels	24-30 Rc >30-38 Rc	• •	• •	• •	• •	• •	• •	• •
Unalloyed case hardened steels	≤230 Bhn	•	•	•	•	•	•	•
Alloyed case hardened steels	24-30 Rc >30-38 Rc	• •	• •	• •	• •	• •	• •	• •
Nitriding steels	≥24-30 Rc >30-38 Rc	• •	• •	• •	• •	• •	• •	• •
Tool steels	≤24 Rc >24-30 Rc	• •	• •	• •	• •	• •	• •	• •
High speed steels	≥14-30 Rc	•	•	•	•	•	•	•
Spring steels	≤330 Bhn	•	•	•	•	•	•	•
Stainless steels, sulphured austenitic martensitic	≤24 Rc • • • • • • • •	• • • • • • • •	• • • • • • • •	• • • • • • • •	• • • • • • • •	• • • • • • • •	• • • • • • • •	• • • • • • • •
Hardened steels	≤40-48 Rc >48-60 Rc	• •	• •	• •	• •	• •	• •	• •
Special alloys	≤38 Rc	•	•	•	•	•	•	•
Cast iron	≤240 Bhn >240 Bhn	295 230	0.0125 0.0125	0.0160 0.0160	0.0200 0.0200	0.0200 0.0200	0.0250 0.0250	0.0315 0.0315
Spheroidal graphite iron and malleable cast iron	≤240 Bhn >240 Bhn	230 195	0.0125 0.0100	0.0160 0.0125	0.0200 0.0160	0.0200 0.0160	0.0250 0.0200	0.0315 0.0250
Chilled cast iron	≤350 Bhn	35	0.0040	0.0050	0.0065	0.0065	0.0080	0.0100
Ti and Ti-alloys	≤24 Rc >24-38 Rc	• •	• •	• •	• •	• •	• •	• •
Aluminium and Al-alloys	≤120 Bhn	595	0.0125	0.0160	0.0200	0.0200	0.0250	0.0315
Al wrought alloys	≤150 Bhn	595	0.0125	0.0160	0.0200	0.0200	0.0250	0.0315
Al cast alloys ≤ 10 % Si > 10 % Si	≤200 Bhn • • • • • • •	455 355	0.0125 0.0125	0.0160 0.0160	0.0200 0.0200	0.0200 0.0200	0.0250 0.0250	0.0315 0.0315
Magnesium alloys	≤150 Bhn	590	0.0125	0.0160	0.0200	0.0200	0.0250	0.0315
Copper, low-alloyed	≤120 Bhn	230	0.0100	0.0125	0.0160	0.0160	0.0200	0.0250
Brass, short-chipping long-chipping	≤200 Bhn • • • • • • •	585 390	0.0125 0.0100	0.0160 0.0125	0.0200 0.0160	0.0200 0.0160	0.0250 0.0200	0.0315 0.0250
Bronze, short-chipping	≤200 Bhn >200-260 Bhn	230 160	0.0100 0.0100	0.0125 0.0125	0.0160 0.0160	0.0160 0.0160	0.0200 0.0200	0.0250 0.0250
Bronze, long-chipping	≤24 Rc >24-30 Rc	145 115	0.0100 0.0080	0.0125 0.0100	0.0160 0.0125	0.0160 0.0125	0.0200 0.0160	0.0250 0.0200
Duroplastics	–	165	0.0080	0.0100	0.0125	0.0125	0.0160	0.0200
Thermoplastics	–	165	0.0080	0.0100	0.0125	0.0125	0.0160	0.0200
Reinforced plastics - Kevlar	–	165	0.0080	0.0100	0.0125	0.0125	0.0160	0.0200
Reinforced plastics - GFK / CFK	–	165	0.0080	0.0100	0.0125	0.0125	0.0160	0.0200

Series # 2747 / # 5248 (7xD body)

Material group	Hardness	SFM	Feed Rate - IPR					
			≤16.000 mm	41/64 - 25/32 in. 16.001 - 20.000 mm	51/64 - 31/32 in. 20.001 - 25.000 mm	63/64 - 1 17/64 in. 25.001 - 31.500 mm	1 1/4 - 1 9/16 in. 31.501 - 40.000 mm	1 37/64 - 1 61/64 in. 40.001 - 50.000 mm
Common structural steels	≤100 Bhn >100-260 Bhn	• •	• •	• •	• •	• •	• •	• •
Free-cutting steels	≤24 Rc >24-30 Rc	• •	• •	• •	• •	• •	• •	• •
Unalloyed heat-treatable steels	≤16 Rc 16-24 Rc 24-30 Rc	• • •	• • •	• • •	• • •	• • •	• • •	• • •
Alloyed heat-treatable steels	24-30 Rc >30-38 Rc	• •	• •	• •	• •	• •	• •	• •
Unalloyed case hardened steels	≤230 Bhn	•	•	•	•	•	•	•
Alloyed case hardened steels	24-30 Rc >30-38 Rc	• •	• •	• •	• •	• •	• •	• •
Nitriding steels	≥24-30 Rc >30-38 Rc	• •	• •	• •	• •	• •	• •	• •
Tool steels	≤24 Rc >24-30 Rc	• •	• •	• •	• •	• •	• •	• •
High speed steels	≥14-30 Rc	•	•	•	•	•	•	•
Spring steels	≤330 Bhn	•	•	•	•	•	•	•
Stainless steels, sulphured austenitic martensitic	≤24 Rc • • • • • • •	• • • • • • •	• • • • • • •	• • • • • • •	• • • • • • •	• • • • • • •	• • • • • • •	• • • • • • •
Hardened steels	≤40-48 Rc >48-60 Rc	• •	• •	• •	• •	• •	• •	• •
Special alloys	≤38 Rc	•	•	•	•	•	•	•
Cast iron	≤240 Bhn >240 Bhn	295 230	0.0100 0.0100	0.0125 0.0125	0.0160 0.0160	0.0160 0.0160	0.0200 0.0200	0.0250 0.0250
Spheroidal graphite iron and malleable cast iron	≤240 Bhn >240 Bhn	230 195	0.0100 0.0080	0.0125 0.0100	0.0160 0.0125	0.0160 0.0125	0.0200 0.0160	0.0250 0.0200
Chilled cast iron	≤350 Bhn	35	0.0040	0.0050	0.0065	0.0065	0.0080	0.0100
Ti and Ti-alloys	≤24 Rc >24-38 Rc	• •	• •	• •	• •	• •	• •	• •
Aluminium and Al-alloys	≤120 Bhn	595	0.0100	0.0125	0.0160	0.0160	0.0200	0.0250
Al wrought alloys	≤150 Bhn	595	0.0100	0.0125	0.0160	0.0160	0.0200	0.0250
Al cast alloys ≤ 10 % Si > 10 % Si	≤200 Bhn • • • • • • •	455 355	0.0100 0.0100	0.0125 0.0125	0.0160 0.0160	0.0160 0.0160	0.0200 0.0200	0.0250 0.0250
Magnesium alloys	≤150 Bhn	590	0.0100	0.0125	0.0160	0.0160	0.0200	0.0250
Copper, low-alloyed	≤120 Bhn	230	0.0080	0.0100	0.0125	0.0125	0.0160	0.0200
Brass, short-chipping long-chipping	≤200 Bhn • • • • • • •	585 390	0.0100 0.0080	0.0125 0.0100	0.0160 0.0125	0.0160 0.0125	0.0200 0.0160	0.0250 0.0200
Bronze, short-chipping	≤200 Bhn >200-260 Bhn	230 160	0.0080 0.0080	0.0100 0.0100	0.0125 0.0125	0.0125 0.0125	0.0160 0.0160	0.0200 0.0200
Bronze, long-chipping	≤24 Rc >24-30 Rc	145 115	0.0080 0.0065	0.0100 0.0080	0.0125 0.0100	0.0125 0.0100	0.0160 0.0125	0.0200 0.0160
Duroplastics	–	165	0.0065	0.0080	0.0100	0.0100	0.0125	0.0160
Thermoplastics	–	165	0.0065	0.0080	0.0100	0.0100	0.0125	0.0160
Reinforced plastics - Kevlar	–	165	0.0065	0.0080	0.0100	0.0100	0.0125	0.0160
Reinforced plastics - GFK / CFK	–	165	0.0065	0.0080	0.0100	0.0100	0.0125	0.0160

Note: When drilling from solid with #5248 holder, spot drilling (≥140° point angle to a depth of at least 2/3 insert diameter) is recommended.

Using These Tables. The Speeds & Feeds listed below are conservative recommendations for initial setup. In actual use, depending on the machining environment and workpiece material, significantly higher speeds and feeds may be achievable. Using the below as a starting point, cutting speed/feed can be gradually adjusted upwards until the optimum settings per application are found.
 Questions? Contact us by telephone at (800) 776-6170.

Series # 3899

Material group	Hardness	SFM	Feed Rate - IPR									
			0.0039 in. 0.100 mm	0.0063 in. 0.160 mm	0.0098 in. 0.250 mm	0.0197 in. 0.500 mm	0.0315 in. 0.800 mm	0.0394 in. 1.000 mm	0.0591 in. 1.500 mm	0.0787 in. 2.000 mm	0.0984 in. 2.500 mm	0.1181 in. 3.000 mm
Common structural steels	≤100 Bhn	330	0.0002	0.0003	0.0004	0.0008	0.0024	0.0031	0.0047	0.0063	0.0079	0.0094
	>100-260 Bhn	330	0.0002	0.0002	0.0003	0.0008	0.0024	0.0031	0.0047	0.0063	0.0079	0.0094
Free-cutting steels	≤24 Rc	330	0.0002	0.0003	0.0004	0.0008	0.0024	0.0031	0.0047	0.0063	0.0079	0.0094
	>24-30 Rc	295	0.0002	0.0002	0.0003	0.0004	0.0020	0.0028	0.0039	0.0055	0.0067	0.0083
Unalloyed heat-treatable steels	≤16 Rc	295	0.0002	0.0002	0.0003	0.0008	0.0024	0.0031	0.0047	0.0063	0.0079	0.0094
	16-24 Rc	295	0.0002	0.0002	0.0003	0.0008	0.0024	0.0031	0.0047	0.0063	0.0079	0.0094
	24-30 Rc	295	0.0001	0.0002	0.0002	0.0004	0.0020	0.0028	0.0039	0.0055	0.0067	0.0083
Alloyed heat-treatable steels	24-30 Rc	295	0.0001	0.0002	0.0002	0.0004	0.0020	0.0028	0.0039	0.0055	0.0067	0.0083
	>30-38 Rc	230	0.0001	0.0001	0.0002	0.0003	0.0016	0.0024	0.0035	0.0047	0.0059	0.0071
Unalloyed case hardened steels	≤230 Bhn	330	0.0001	0.0002	0.0002	0.0004	0.0020	0.0028	0.0039	0.0055	0.0067	0.0083
Alloyed case hardened steels	24-30 Rc	280	0.0001	0.0002	0.0002	0.0004	0.0020	0.0028	0.0039	0.0055	0.0067	0.0083
	>30-38 Rc	230	0.0001	0.0001	0.0002	0.0003	0.0016	0.0024	0.0035	0.0047	0.0059	0.0071
Nitriding steels	≥24-30 Rc	230	0.0001	0.0002	0.0002	0.0003	0.0016	0.0024	0.0035	0.0047	0.0059	0.0071
	>30-38 Rc	195	0.0001	0.0001	0.0002	0.0003	0.0016	0.0024	0.0035	0.0047	0.0059	0.0071
Tool steels	≤24 Rc	165	0.0001	0.0002	0.0002	0.0003	0.0016	0.0024	0.0035	0.0047	0.0059	0.0071
	>24-30 Rc	195	0.0001	0.0001	0.0002	0.0003	0.0016	0.0024	0.0035	0.0047	0.0059	0.0071
High speed steels	≥14-30 Rc											
Spring steels	≤330 Bhn											
Stainless steels, sulphured austenitic martensitic	≤24 Rc											
	≤24 Rc											
	≤24 Rc											
Hardened steels	≤40-48 Rc											
	>48-60 Rc											
Special alloys	≤38 Rc											
Cast iron	≤240 Bhn	425	0.0002	0.0003	0.0004	0.0022	0.0031	0.0043	0.0063	0.0087	0.0106	0.0130
	<300 Bhn	425	0.0002	0.0003	0.0004	0.0022	0.0031	0.0043	0.0063	0.0087	0.0106	0.0130
Spheroidal graphite iron and malleable cast iron	≤240 Bhn	425	0.0002	0.0003	0.0004	0.0022	0.0031	0.0043	0.0063	0.0087	0.0106	0.0130
	<300 Bhn	395	0.0002	0.0003	0.0004	0.0020	0.0031	0.0039	0.0059	0.0083	0.0102	0.0122
Chilled cast iron	≤350 Bhn											
Ti and Ti-alloys	≤24 Rc											
	>24-38 Rc											
Aluminium and Al-alloys	≤120 Bhn											
Al wrought alloys	≤150 Bhn											
Al cast alloys ≤ 10 % Si > 10 % Si	≤200 Bhn											
	≤200 Bhn											
Magnesium alloys	≤150 Bhn											
Copper, low-alloyed	≤120 Bhn											
Brass, short-chipping long-chipping	≤200 Bhn											
	≤200 Bhn											
Bronze, short-chipping	≤200 Bhn											
Bronze, long-chipping	>200-260 Bhn											
	≤24 Rc >24-30 Rc											
Duroplastics	-											
Thermoplastics	-											
Reinforced plastics - Kevlar	-											
Reinforced plastics - GFK / CFK	-											

Series # 4024 / # 4042 (3xD body)

Material group	Hardness	SFM	Feed Rate - IPR			
			29/64 - 31/64 in. 11.500 - 12.500 mm	1/2 - 5/8 in. 12.501 - 15.870 mm		
Common structural steels	≤100 Bhn	•	•	•	•	•
	>100-260 Bhn	•	•	•	•	•
Free-cutting steels	≤24 Rc	•	•	•	•	•
	>24-30 Rc	•	•	•	•	•
Unalloyed heat-treatable steels	≤16 Rc	•	•	•	•	•
	16-24 Rc	•	•	•	•	•
	24-30 Rc	•	•	•	•	•
Alloyed heat-treatable steels	24-30 Rc	•	•	•	•	•
	>30-38 Rc	•	•	•	•	•
Unalloyed case hardened steels	≤230 Bhn	•	•	•	•	•
Alloyed case hardened steels	24-30 Rc	•	•	•	•	•
	>30-38 Rc	•	•	•	•	•
Nitriding steels	≥24-30 Rc	•	•	•	•	•
	>30-38 Rc	•	•	•	•	•
Tool steels	≤24 Rc	•	•	•	•	•
	>24-30 Rc	•	•	•	•	•
High speed steels	≥14-30 Rc	•	•	•	•	•
Spring steels	≤330 Bhn	•	•	•	•	•
Stainless steels, sulphured austenitic martensitic	≤24 Rc	•	•	•	•	•
	≤24 Rc	•	•	•	•	•
	≤24 Rc	•	•	•	•	•
Hardened steels	≤40-48 Rc	•	•	•	•	•
	>48-60 Rc	•	•	•	•	•
Special alloys	≤38 Rc	•	•	•	•	•
Cast iron	≤240 Bhn	325	0.0125	0.0160	•	•
	<300 Bhn	260	0.0125	0.0160	•	•
Spheroidal graphite iron and malleable cast iron	≤240 Bhn	260	0.0125	0.0160	•	•
	<300 Bhn	230	0.0100	0.0125	•	•
Chilled cast iron	≤350 Bhn	30	0.0040	0.0050	•	•
Ti and Ti-alloys	≤24 Rc	•	•	•	•	•
	>24-38 Rc	•	•	•	•	•
Aluminium and Al-alloys	≤120 Bhn	655	0.0125	0.0160	•	•
Al wrought alloys	≤150 Bhn	590	0.0125	0.0160	•	•
Al cast alloys ≤ 10 % Si > 10 % Si	≤200 Bhn	490	0.0125	0.0160	•	•
	≤200 Bhn	390	0.0125	0.0160	•	•
Magnesium alloys	≤150 Bhn	590	0.0125	0.0160	•	•
Copper, low-alloyed	≤120 Bhn	230	0.0100	0.0125	•	•
Brass, short-chipping long-chipping	≤200 Bhn	585	0.0125	0.0160	•	•
	≤200 Bhn	390	0.0100	0.0125	•	•
Bronze, short-chipping	≤200 Bhn	230	0.0100	0.0125	•	•
Bronze, long-chipping	>200-260 Bhn	160	0.0100	0.0125	•	•
	≤24 Rc >24-30 Rc	145 115	0.0100 0.0080	0.0125 0.0100	•	•
Duroplastics	-	165	0.0080	0.0100	•	•
Thermoplastics	-	165	0.0080	0.0100	•	•
Reinforced plastics - Kevlar	-	165	0.0080	0.0100	•	•
Reinforced plastics - GFK / CFK	-	165	0.0080	0.0100	•	•

$$\text{RPM} = \frac{\text{SFM}}{\text{DIAM. in.}} \times 3.82 \quad \text{IPM} = \text{IPR} \times \text{RPM}$$

$$\frac{\text{HOLE DEPTH in.}}{\text{IPM}} \times 60 = \text{Cut Time}$$

$$\text{mm} = \text{in.} \times 25.40$$

$$\text{m/min.} = \text{SFM} \div 3.28$$

$$\text{Bar} = \text{PSI} \div 14.50$$

$$\text{mm/rev.} = \text{IPR} \times 25.40$$

$$\text{Liter} = \text{Gal.} \div 3.79$$

Series # 4024 / # 4043 (5xD body)

Material group	Hardness	SFM	Feed Rate - IPR				
			29/64 - 31/64 in. 11.500 - 12.500 mm	1/2 - 5/8 in. 12.501 - 15.870 mm			
Common structural steels	≤100 Bhn >100-260 Bhn	• •	• •	• •	• •	• •	• •
Free-cutting steels	≤24 Rc >24-30 Rc	• •	• •	• •	• •	• •	• •
Unalloyed heat-treatable steels	≤16 Rc 16-24 Rc 24-30 Rc	• • •	• • •	• • •	• • •	• • •	• • •
Alloyed heat-treatable steels	24-30 Rc >30-38 Rc	• •	• •	• •	• •	• •	• •
Unalloyed case hardened steels	≤230 Bhn	•	•	•	•	•	•
Alloyed case hardened steels	24-30 Rc >30-38 Rc	• •	• •	• •	• •	• •	• •
Nitriding steels	≥24-30 Rc >30-38 Rc	• •	• •	• •	• •	• •	• •
Tool steels	≤24 Rc >24-30 Rc	• •	• •	• •	• •	• •	• •
High speed steels	≥14-30 Rc	•	•	•	•	•	•
Spring steels	≤330 Bhn	•	•	•	•	•	•
Stainless steels, sulphured austenitic martensitic	≤24 Rc ≤24 Rc ≤24 Rc	• • •	• • •	• • •	• • •	• • •	• • •
Hardened steels	≤40-48 Rc >48-60 Rc	• •	• •	• •	• •	• •	• •
Special alloys	≤38 Rc	•	•	•	•	•	•
Cast iron	≤240 Bhn <300 Bhn	295 230	0.0125 0.0125	0.0160 0.0160	• •	• •	• •
Spheroidal graphite iron and malleable cast iron	≤240 Bhn <300 Bhn	230 195	0.0125 0.0100	0.0160 0.0125	• •	• •	• •
Chilled cast iron	≤350 Bhn	30	0.0040	0.0050	•	•	•
Ti and Ti-alloys	≤24 Rc >24-38 Rc	• •	• •	• •	• •	• •	• •
Aluminium and Al-alloys	≤120 Bhn	590	0.0125	0.0160	•	•	•
Al wrought alloys	≤150 Bhn	590	0.0125	0.0160	•	•	•
Al cast alloys ≤ 10 % Si > 10 % Si	≤200 Bhn ≤200 Bhn	455 355	0.0125 0.0125	0.0160 0.0160	• •	• •	• •
Magnesium alloys	≤150 Bhn	590	0.0125	0.0160	•	•	•
Copper, low-alloyed	≤120 Bhn	230	0.0100	0.0125	•	•	•
Brass, short-chipping long-chipping	≤200 Bhn ≤200 Bhn	585 390	0.0125 0.0100	0.0160 0.0125	• •	• •	• •
Bronze, short-chipping	≤200 Bhn >200-260 Bhn	230 160	0.0100 0.0100	0.0125 0.0125	• •	• •	• •
Bronze, long-chipping	≤24 Rc >24-30 Rc	145 115	0.0100 0.0080	0.0125 0.0100	• •	• •	• •
Duroplastics	-	165	0.0080	0.0100	•	•	•
Thermoplastics	-	165	0.0080	0.0100	•	•	•
Reinforced plastics - Kevlar	-	165	0.0080	0.0100	•	•	•
Reinforced plastics - GFK / CFK	-	165	0.0080	0.0100	•	•	•

Series # 4024 / # 4048 (7xD body)

Material group	Hardness	SFM	Feed Rate - IPR				
			29/64 - 31/64 in. 11.500 - 12.500 mm	1/2 - 5/8 in. 12.501 - 15.870 mm			
Common structural steels	≤100 Bhn >100-260 Bhn	• •	• •	• •	• •	• •	• •
Free-cutting steels	≤24 Rc >24-30 Rc	• •	• •	• •	• •	• •	• •
Unalloyed heat-treatable steels	≤16 Rc 16-24 Rc 24-30 Rc	• • •	• • •	• • •	• • •	• • •	• • •
Alloyed heat-treatable steels	24-30 Rc >30-38 Rc	• •	• •	• •	• •	• •	• •
Unalloyed case hardened steels	≤230 Bhn	•	•	•	•	•	•
Alloyed case hardened steels	24-30 Rc >30-38 Rc	• •	• •	• •	• •	• •	• •
Nitriding steels	≥24-30 Rc >30-38 Rc	• •	• •	• •	• •	• •	• •
Tool steels	≤24 Rc >24-30 Rc	• •	• •	• •	• •	• •	• •
High speed steels	≥14-30 Rc	•	•	•	•	•	•
Spring steels	≤330 Bhn	•	•	•	•	•	•
Stainless steels, sulphured austenitic martensitic	≤24 Rc ≤24 Rc ≤24 Rc	• • •	• • •	• • •	• • •	• • •	• • •
Hardened steels	≤40-48 Rc >48-60 Rc	• •	• •	• •	• •	• •	• •
Special alloys	≤38 Rc	•	•	•	•	•	•
Cast iron	≤240 Bhn <300 Bhn	295 230	0.0100 0.0100	0.0125 0.0125	• •	• •	• •
Spheroidal graphite iron and malleable cast iron	≤240 Bhn <300 Bhn	230 195	0.0100 0.0080	0.0125 0.0100	• •	• •	• •
Chilled cast iron	≤350 Bhn	30	0.0040	0.0050	•	•	•
Ti and Ti-alloys	≤24 Rc >24-38 Rc	• •	• •	• •	• •	• •	• •
Aluminium and Al-alloys	≤120 Bhn	590	0.0100	0.0125	•	•	•
Al wrought alloys	≤150 Bhn	590	0.0100	0.0125	•	•	•
Al cast alloys ≤ 10 % Si > 10 % Si	≤200 Bhn ≤200 Bhn	455 355	0.0100 0.0100	0.0125 0.0125	• •	• •	• •
Magnesium alloys	≤150 Bhn	590	0.0100	0.0125	•	•	•
Copper, low-alloyed	≤120 Bhn	230	0.0080	0.0100	•	•	•
Brass, short-chipping long-chipping	≤200 Bhn ≤200 Bhn	585 390	0.0100 0.0080	0.0125 0.0100	• •	• •	• •
Bronze, short-chipping	≤200 Bhn >200-260 Bhn	230 160	0.0080 0.0080	0.0100 0.0100	• •	• •	• •
Bronze, long-chipping	≤24 Rc >24-30 Rc	145 115	0.0080 0.0065	0.0100 0.0080	• •	• •	• •
Duroplastics	-	165	0.0065	0.0080	•	•	•
Thermoplastics	-	165	0.0065	0.0080	•	•	•
Reinforced plastics - Kevlar	-	165	0.0065	0.0080	•	•	•
Reinforced plastics - GFK / CFK	-	165	0.0065	0.0080	•	•	•

Using These Tables. The Speeds & Feeds listed below are conservative recommendations for initial setup. In actual use, depending on the machining environment and workpiece material, significantly higher speeds and feeds may be achievable. Using the below as a starting point, cutting speed/feed can be gradually adjusted upwards until the optimum settings per application are found.
 Questions? Contact us by telephone at (800) 776-6170.

Series # 4025 / # 4042 (3xD body)

Material group	Hardness	SFM	Feed Rate - IPR			
			29/64 - 31/64 in. 11.500 - 12.500 mm	1/2 - 5/8 in. 12.501 - 15.870 mm		
Common structural steels	≤100 Bhn	325	0.0100	0.0125	•	•
	>100-260 Bhn	275	0.0080	0.0100	•	•
Free-cutting steels	≤24 Rc	325	0.0125	0.0160	•	•
	>24-30 Rc	275	0.0100	0.0125	•	•
Unalloyed heat-treatable steels	≤16 Rc	325	0.0100	0.0125	•	•
	16-24 Rc	310	0.0100	0.0125	•	•
	24-30 Rc	275	0.0080	0.0100	•	•
	>30-38 Rc	225	0.0100	0.0100	•	•
Alloyed heat-treatable steels	24-30 Rc	275	0.0100	0.0125	•	•
	>30-38 Rc	225	0.0080	0.0100	•	•
Unalloyed case hardened steels	≤230 Bhn	325	0.0125	0.0160	•	•
Alloyed case hardened steels	24-30 Rc	275	0.0100	0.0125	•	•
	>30-38 Rc	180	0.0065	0.0080	•	•
Nitriding steels	≥24-30 Rc	260	0.0080	0.0100	•	•
	>30-38 Rc	180	0.0065	0.0080	•	•
Tool steels	≤24 Rc	130	0.0080	0.0100	•	•
	>24-30 Rc	110	0.0065	0.0080	•	•
High speed steels	≥14-30 Rc	130	0.0050	0.0065	•	•
Spring steels	≤330 Bhn	110	0.0040	0.0050	•	•
Stainless steels, sulphured austenitic martensitic	≤24 Rc	130	0.0050	0.0065	•	•
	≤24 Rc	95	0.0050	0.0065	•	•
	≤24 Rc	80	0.0050	0.0065	•	•
Hardened steels	≤40-48 Rc	65	0.0040	0.0050	•	•
	>48-60 Rc	•	•	•	•	•
Special alloys	≤38 Rc	65	0.0040	0.0050	•	•
Cast iron	≤240 Bhn	520	0.0125	0.0160	•	•
	<300 Bhn	390	0.0125	0.0160	•	•
Spheroidal graphite iron and malleable cast iron	≤240 Bhn	390	0.0125	0.0160	•	•
	<300 Bhn	325	0.0100	0.0125	•	•
Chilled cast iron	≤350 Bhn	80	0.0040	0.0050	•	•
Ti and Ti-alloys	≤24 Rc	95	0.0050	0.0065	•	•
	>24-38 Rc	80	0.0040	0.0050	•	•
Aluminium and Al-alloys	≤120 Bhn	720	0.0125	0.0160	•	•
Al wrought alloys	≤150 Bhn	655	0.0125	0.0160	•	•
Al cast alloys ≤ 10 % Si	≤200 Bhn	590	0.0125	0.0160	•	•
> 10 % Si	≤200 Bhn	490	0.0125	0.0160	•	•
Magnesium alloys	≤150 Bhn	655	0.0125	0.0160	•	•
Copper, low-alloyed	≤120 Bhn	260	0.0100	0.0125	•	•
Brass, short-chipping long-chipping	≤200 Bhn	685	0.0125	0.0160	•	•
	≤200 Bhn	455	0.0100	0.0125	•	•
Bronze, short-chipping	≤200 Bhn	260	0.0100	0.0125	•	•
	>200-260 Bhn	210	0.0100	0.0125	•	•
Bronze, long-chipping	≤24 Rc	160	0.0100	0.0125	•	•
	>24-30 Rc	130	0.0080	0.0100	•	•
Duroplastics	-	260	0.0080	0.0100	•	•
Thermoplastics	-	260	0.0080	0.0100	•	•
Reinforced plastics - Kevlar	-	260	0.0080	0.0100	•	•
Reinforced plastics - GFK / CFK	-	260	0.0080	0.0100	•	•

Series # 4025 / # 4043 (5xD body)

Material group	Hardness	SFM	Feed Rate - IPR			
			29/64 - 31/64 in. 11.500 - 12.500 mm	1/2 - 5/8 in. 12.501 - 15.870 mm		
Common structural steels	≤100 Bhn	310	0.0100	0.0125	•	•
	>100-260 Bhn	260	0.0080	0.0100	•	•
Free-cutting steels	≤24 Rc	310	0.0125	0.0160	•	•
	>24-30 Rc	260	0.0100	0.0125	•	•
Unalloyed heat-treatable steels	≤16 Rc	310	0.0100	0.0125	•	•
	16-24 Rc	295	0.0100	0.0125	•	•
	24-30 Rc	260	0.0080	0.0100	•	•
	>30-38 Rc	210	0.0080	0.0100	•	•
Alloyed heat-treatable steels	24-30 Rc	260	0.0100	0.0125	•	•
	>30-38 Rc	210	0.0080	0.0100	•	•
Unalloyed case hardened steels	≤230 Bhn	310	0.0125	0.0160	•	•
Alloyed case hardened steels	24-30 Rc	260	0.0100	0.0125	•	•
	>30-38 Rc	180	0.0065	0.0080	•	•
Nitriding steels	≥24-30 Rc	260	0.0080	0.0100	•	•
	>30-38 Rc	180	0.0065	0.0080	•	•
Tool steels	≤24 Rc	130	0.0080	0.0100	•	•
	>24-30 Rc	110	0.0065	0.0080	•	•
High speed steels	≥14-30 Rc	130	0.0050	0.0065	•	•
Spring steels	≤330 Bhn	110	0.0040	0.0050	•	•
Stainless steels, sulphured austenitic martensitic	≤24 Rc	130	0.0050	0.0065	•	•
	≤24 Rc	95	0.0050	0.0065	•	•
	≤24 Rc	80	0.0050	0.0065	•	•
Hardened steels	≤40-48 Rc	65	0.0040	0.0050	•	•
	>48-60 Rc	•	•	•	•	•
Special alloys	≤38 Rc	65	0.0040	0.0050	•	•
Cast iron	≤240 Bhn	490	0.0125	0.0160	•	•
	<300 Bhn	360	0.0125	0.0160	•	•
Spheroidal graphite iron and malleable cast iron	≤240 Bhn	360	0.0125	0.0160	•	•
	<300 Bhn	295	0.0100	0.0125	•	•
Chilled cast iron	≤350 Bhn	80	0.0040	0.0050	•	•
Ti and Ti-alloys	≤24 Rc	95	0.0050	0.0065	•	•
	>24-38 Rc	80	0.0040	0.0050	•	•
Aluminium and Al-alloys	≤120 Bhn	655	0.0125	0.0160	•	•
Al wrought alloys	≤150 Bhn	655	0.0125	0.0160	•	•
Al cast alloys ≤ 10 % Si	≤200 Bhn	555	0.0125	0.0160	•	•
> 10 % Si	≤200 Bhn	455	0.0125	0.0160	•	•
Magnesium alloys	≤150 Bhn	655	0.0125	0.0160	•	•
Copper, low-alloyed	≤120 Bhn	260	0.0100	0.0125	•	•
Brass, short-chipping long-chipping	≤200 Bhn	685	0.0125	0.0160	•	•
	≤200 Bhn	455	0.0100	0.0125	•	•
Bronze, short-chipping	≤200 Bhn	260	0.0100	0.0125	•	•
	>200-260 Bhn	210	0.0100	0.0125	•	•
Bronze, long-chipping	≤24 Rc	160	0.0100	0.0125	•	•
	>24-30 Rc	130	0.0080	0.0100	•	•
Duroplastics	-	260	0.0080	0.0100	•	•
Thermoplastics	-	260	0.0080	0.0100	•	•
Reinforced plastics - Kevlar	-	260	0.0080	0.0100	•	•
Reinforced plastics - GFK / CFK	-	260	0.0080	0.0100	•	•

$$\text{RPM} = \frac{\text{SFM}}{\text{DIAM. in.}} \times 3.82 \quad \text{IPM} = \text{IPR} \times \text{RPM}$$

$$\frac{\text{HOLE DEPTH in.}}{\text{IPM}} \times 60 = \text{Cut Time}$$

$$\text{mm} = \text{in.} \times 25.40$$

$$\text{m/min.} = \text{SFM} \div 3.28$$

$$\text{Bar} = \text{PSI} \div 14.50$$

$$\text{mm/rev.} = \text{IPR} \times 25.40$$

$$\text{Liter} = \text{Gal.} \div 3.79$$

Series # 4025 / # 4048 (7xD body)

Material group	Hardness	SFM	Feed Rate - IPR					
			29/64 - 31/64 in. 11.500 - 12.500 mm	1/2 - 5/8 in. 12.501 - 15.870 mm				
Common structural steels	≤100 Bhn >100-260 Bhn	295 260	0.0080 0.0065	0.0100 0.0080	•	•	•	•
Free-cutting steels	≤24 Rc >24-30 Rc	295 260	0.0100 0.0080	0.0125 0.0100	•	•	•	•
Unalloyed heat-treatable steels	≤16 Rc 16-24 Rc 24-30 Rc	295 275 245	0.0080 0.0080 0.0065	0.0100 0.0100 0.0080	•	•	•	•
Alloyed heat-treatable steels	24-30 Rc >30-38 Rc	245 210	0.0080 0.0065	0.0100 0.0080	•	•	•	•
Unalloyed case hardened steels	≤230 Bhn	295	0.0100	0.0125	•	•	•	•
Alloyed case hardened steels	24-30 Rc >30-38 Rc	245 180	0.0080 0.0065	0.0100 0.0080	•	•	•	•
Nitriding steels	≥24-30 Rc >30-38 Rc	260 180	0.0080 0.0065	0.0100 0.0080	•	•	•	•
Tool steels	≤24 Rc >24-30 Rc	130 110	0.0065 0.0050	0.0080 0.0065	•	•	•	•
High speed steels	≥14-30 Rc	130	0.0040	0.0050	•	•	•	•
Spring steels	≤330 Bhn	110	0.0040	0.0050	•	•	•	•
Stainless steels, sulphured austenitic	≤24 Rc	130	0.0040	0.0050	•	•	•	•
Stainless steels, sulphured martensitic	≤24 Rc	95 80	0.0040 0.0040	0.0050 0.0050	•	•	•	•
Hardened steels	≤40-48 Rc >48-60 Rc	65 •	0.0035 •	0.0040 •	•	•	•	•
Special alloys	≤38 Rc	65	0.0035	0.0040	•	•	•	•
Cast iron	≤240 Bhn <300 Bhn	490 360	0.0100 0.0100	0.0125 0.0125	•	•	•	•
Spheroidal graphite iron and malleable cast iron	≤240 Bhn <300 Bhn	360 295	0.0100 0.0080	0.0125 0.0100	•	•	•	•
Chilled cast iron	≤350 Bhn	80	0.0040	0.0050	•	•	•	•
Ti and Ti-alloys	≤24 Rc >24-38 Rc	95 80	0.0040 0.0035	0.0050 0.0040	•	•	•	•
Aluminium and Al-alloys	≤120 Bhn	655	0.0100	0.0125	•	•	•	•
Al wrought alloys	≤150 Bhn	655	0.0100	0.0125	•	•	•	•
Al cast alloys ≤ 10 % Si	≤200 Bhn	555	0.0100	0.0125	•	•	•	•
Al cast alloys > 10 % Si	≤200 Bhn	455	0.0100	0.0125	•	•	•	•
Magnesium alloys	≤150 Bhn	655	0.0100	0.0125	•	•	•	•
Copper, low-alloyed	≤120 Bhn	260	0.0080	0.0100	•	•	•	•
Brass, short-chipping	≤200 Bhn	685	0.0100	0.0125	•	•	•	•
Brass, long-chipping	≤200 Bhn	455	0.0080	0.0100	•	•	•	•
Bronze, short-chipping	≤200 Bhn >200-260 Bhn	260 210	0.0080 0.0080	0.0100 0.0100	•	•	•	•
Bronze, long-chipping	≤24 Rc >24-30 Rc	160 130	0.0080 0.0065	0.0100 0.0080	•	•	•	•
Duroplastics	-	260	0.0065	0.0080	•	•	•	•
Thermoplastics	-	260	0.0065	0.0080	•	•	•	•
Reinforced plastics - Kevlar	-	260	0.0065	0.0080	•	•	•	•
Reinforced plastics - GFK / CFK	-	260	0.0065	0.0080	•	•	•	•

Series # 4026 / # 4043 (5xD body)

Material group	Hardness	SFM	Feed Rate - IPR					
			≤16.000 mm	41/64 - 25/32 in. 16.001 - 20.000 mm				
Common structural steels	≤100 Bhn >100-260 Bhn	410 340	0.0100 0.0080	0.0125 0.0100	•	•	•	•
Free-cutting steels	≤24 Rc >24-30 Rc	410 340	0.0125 0.0100	0.0160 0.0125	•	•	•	•
Unalloyed heat-treatable steels	≤16 Rc 16-24 Rc 24-30 Rc	410 390 340	0.0100 0.0100 0.0080	0.0125 0.0125 0.0100	•	•	•	•
Alloyed heat-treatable steels	24-30 Rc >30-38 Rc	340 275	0.0100 0.0080	0.0125 0.0100	•	•	•	•
Unalloyed case hardened steels	≤230 Bhn	410	0.0125	0.0160	•	•	•	•
Alloyed case hardened steels	24-30 Rc >30-38 Rc	340 225	0.0100 0.0065	0.0125 0.0080	•	•	•	•
Nitriding steels	≥24-30 Rc >30-38 Rc	340 225	0.0080 0.0065	0.0100 0.0080	•	•	•	•
Tool steels	≤24 Rc >24-30 Rc	180 160	0.0080 0.0065	0.0100 0.0080	•	•	•	•
High speed steels	≥14-30 Rc	180	0.0050	0.0065	•	•	•	•
Spring steels	≤330 Bhn	160	0.0040	0.0050	•	•	•	•
Stainless steels, sulphured austenitic	≤24 Rc	180	0.0050	0.0065	•	•	•	•
Stainless steels, sulphured martensitic	≤24 Rc	130 110	0.0050 0.0050	0.0065 0.0065	•	•	•	•
Hardened steels	≤40-48 Rc >48-60 Rc	80 •	0.0040 •	0.0050 •	•	•	•	•
Special alloys	≤38 Rc	80	0.0040	0.0050	•	•	•	•
Cast iron	≤240 Bhn <300 Bhn	635 475	0.0125 0.0125	0.0160 0.0160	•	•	•	•
Spheroidal graphite iron and malleable cast iron	≤240 Bhn <300 Bhn	475 390	0.0125 0.0100	0.0160 0.0125	•	•	•	•
Chilled cast iron	≤350 Bhn	110	0.0040	0.0050	•	•	•	•
Ti and Ti-alloys	≤24 Rc >24-38 Rc	130 110	0.0050 0.0040	0.0065 0.0050	•	•	•	•
Aluminium and Al-alloys	≤120 Bhn	850	0.0125	0.0160	•	•	•	•
Al wrought alloys	≤150 Bhn	850	0.0125	0.0160	•	•	•	•
Al cast alloys ≤ 10 % Si	≤200 Bhn	720	0.0125	0.0160	•	•	•	•
Al cast alloys > 10 % Si	≤200 Bhn	590	0.0125	0.0160	•	•	•	•
Magnesium alloys	≤150 Bhn	850	0.0125	0.0160	•	•	•	•
Copper, low-alloyed	≤120 Bhn	340	0.0100	0.0125	•	•	•	•
Brass, short-chipping	≤200 Bhn	885	0.0125	0.0160	•	•	•	•
Brass, long-chipping	≤200 Bhn	590	0.0100	0.0125	•	•	•	•
Bronze, short-chipping	≤200 Bhn >200-260 Bhn	340 275	0.0100 0.0100	0.0125 0.0125	•	•	•	•
Bronze, long-chipping	≤24 Rc >24-30 Rc	210 180	0.0100 0.0080	0.0125 0.0100	•	•	•	•
Duroplastics	-	340	0.0080	0.0100	•	•	•	•
Thermoplastics	-	340	0.0080	0.0100	•	•	•	•
Reinforced plastics - Kevlar	-	340	0.0080	0.0100	•	•	•	•
Reinforced plastics - GFK / CFK	-	340	0.0080	0.0100	•	•	•	•

Using These Tables. The Speeds & Feeds listed below are conservative recommendations for initial setup. In actual use, depending on the machining environment and workpiece material, significantly higher speeds and feeds may be achievable. Using the below as a starting point, cutting speed/feed can be gradually adjusted upwards until the optimum settings per application are found.
 Questions? Contact us by telephone at (800) 776-6170.

Series # 4026 / # 4048 (7xD body)

Material group	Hardness	SFM	Feed Rate - IPR					
			≤16.000 mm	41/64 - 25/32 in. 16.001 - 20.000 mm	41/64 - 25/32 in. 16.001 - 20.000 mm	63/64 - 1 17/64 in. 25.001 - 31.500 mm	1 1/4 - 1 9/16 in. 31.501 - 40.000 mm	1 37/64 - 1 61/64 in. 40.001 - 50.000 mm
Common structural steels	≤100 Bhn	390	0.0080	0.0100	•	•	•	•
	>100-260 Bhn	340	0.0065	0.0080	•	•	•	•
Free-cutting steels	≤24 Rc	390	0.0100	0.0125	•	•	•	•
	>24-30 Rc	340	0.0080	0.0100	•	•	•	•
Unalloyed heat-treatable steels	≤16 Rc	390	0.0080	0.0100	•	•	•	•
	16-24 Rc	360	0.0080	0.0100	•	•	•	•
	24-30 Rc	325	0.0065	0.0080	•	•	•	•
Alloyed heat-treatable steels	24-30 Rc	325	0.0080	0.0100	•	•	•	•
	>30-38 Rc	275	0.0065	0.0080	•	•	•	•
Unalloyed case hardened steels	≤230 Bhn	390	0.0100	0.0125	•	•	•	•
Alloyed case hardened steels	24-30 Rc	325	0.0080	0.0100	•	•	•	•
	>30-38 Rc	225	0.0065	0.0080	•	•	•	•
Nitriding steels	≥24-30 Rc	340	0.0080	0.0100	•	•	•	•
	>30-38 Rc	225	0.0065	0.0080	•	•	•	•
Tool steels	≤24 Rc	180	0.0065	0.0080	•	•	•	•
	>24-30 Rc	160	0.0050	0.0065	•	•	•	•
High speed steels	≥14-30 Rc	180	0.0040	0.0050	•	•	•	•
Spring steels	≤330 Bhn	160	0.0040	0.0050	•	•	•	•
Stainless steels, sulphured austenitic martensitic	≤24 Rc	180	0.0040	0.0050	•	•	•	•
	≤24 Rc	130	0.0040	0.0050	•	•	•	•
	≤24 Rc	110	0.0040	0.0050	•	•	•	•
Hardened steels	≤40-48 Rc	80	0.0035	0.0040	•	•	•	•
	>48-60 Rc	•	•	•	•	•	•	•
Special alloys	≤38 Rc	80	0.0035	0.0040	•	•	•	•
Cast iron	≤240 Bhn	635	0.0100	0.0125	•	•	•	•
	<300 Bhn	475	0.0100	0.0125	•	•	•	•
Spheroidal graphite iron and malleable cast iron	≤240 Bhn	475	0.0100	0.0125	•	•	•	•
	<300 Bhn	390	0.0080	0.0100	•	•	•	•
Chilled cast iron	≤350 Bhn	110	0.0040	0.0050	•	•	•	•
Ti and Ti-alloys	≤24 Rc	130	0.0040	0.0050	•	•	•	•
	>24-38 Rc	110	0.0035	0.0040	•	•	•	•
Aluminium and Al-alloys	≤120 Bhn	850	0.0100	0.0125	•	•	•	•
Al wrought alloys	≤150 Bhn	850	0.0100	0.0125	•	•	•	•
Al cast alloys ≤ 10 % Si > 10 % Si	≤200 Bhn	720	0.0100	0.0125	•	•	•	•
	≤200 Bhn	590	0.0100	0.0125	•	•	•	•
Magnesium alloys	≤150 Bhn	850	0.0100	0.0125	•	•	•	•
Copper, low-alloyed	≤120 Bhn	340	0.0080	0.0100	•	•	•	•
Brass, short-chipping long-chipping	≤200 Bhn	885	0.0100	0.0125	•	•	•	•
	≤200 Bhn	590	0.0080	0.0100	•	•	•	•
Bronze, short-chipping	≤200 Bhn	340	0.0080	0.0100	•	•	•	•
	>200-260 Bhn	275	0.0080	0.0100	•	•	•	•
Bronze, long-chipping	≤24 Rc	210	0.0080	0.0100	•	•	•	•
	>24-30 Rc	180	0.0065	0.0080	•	•	•	•
Duroplastics	-	340	0.0065	0.0080	•	•	•	•
Thermoplastics	-	340	0.0065	0.0080	•	•	•	•
Reinforced plastics - Kevlar	-	340	0.0065	0.0080	•	•	•	•
Reinforced plastics - GFK / CFK	-	340	0.0065	0.0080	•	•	•	•

Series # 4026 / # 4042 (3xD body)

Material group	Hardness	SFM	Feed Rate - IPR					
			≤16.000 mm	41/64 - 25/32 in. 16.001 - 20.000 mm				
Common structural steels	≤100 Bhn	425	0.0100	0.0125	•	•	•	•
	>100-260 Bhn	360	0.0080	0.0100	•	•	•	•
Free-cutting steels	≤24 Rc	425	0.0125	0.0160	•	•	•	•
	>24-30 Rc	360	0.0100	0.0125	•	•	•	•
Unalloyed heat-treatable steels	≤16 Rc	425	0.0100	0.0125	•	•	•	•
	16-24 Rc	410	0.0100	0.0125	•	•	•	•
	24-30 Rc	360	0.0080	0.0100	•	•	•	•
Alloyed heat-treatable steels	24-30 Rc	360	0.0100	0.0125	•	•	•	•
	>30-38 Rc	295	0.0080	0.0100	•	•	•	•
Unalloyed case hardened steels	≤230 Bhn	425	0.0125	0.0160	•	•	•	•
Alloyed case hardened steels	24-30 Rc	360	0.0100	0.0125	•	•	•	•
	>30-38 Rc	225	0.0065	0.0080	•	•	•	•
Nitriding steels	≥24-30 Rc	340	0.0080	0.0100	•	•	•	•
	>30-38 Rc	225	0.0065	0.0080	•	•	•	•
Tool steels	≤24 Rc	180	0.0080	0.0100	•	•	•	•
	>24-30 Rc	160	0.0065	0.0080	•	•	•	•
High speed steels	≥14-30 Rc	180	0.0050	0.0065	•	•	•	•
Spring steels	≤330 Bhn	160	0.0040	0.0050	•	•	•	•
Stainless steels, sulphured austenitic martensitic	≤24 Rc	180	0.0050	0.0065	•	•	•	•
	≤24 Rc	130	0.0050	0.0065	•	•	•	•
	≤24 Rc	110	0.0050	0.0065	•	•	•	•
Hardened steels	≤40-48 Rc	80	0.0040	0.0050	•	•	•	•
	>48-60 Rc	•	•	•	•	•	•	•
Special alloys	≤38 Rc	80	0.0040	0.0050	•	•	•	•
Cast iron	≤240 Bhn	685	0.0125	0.0160	•	•	•	•
	<300 Bhn	505	0.0125	0.0160	•	•	•	•
Spheroidal graphite iron and malleable cast iron	≤240 Bhn	505	0.0125	0.0160	•	•	•	•
	<300 Bhn	425	0.0100	0.0125	•	•	•	•
Chilled cast iron	≤350 Bhn	110	0.0040	0.0050	•	•	•	•
Ti and Ti-alloys	≤24 Rc	130	0.0050	0.0065	•	•	•	•
	>24-38 Rc	110	0.0040	0.0050	•	•	•	•
Aluminium and Al-alloys	≤120 Bhn	950	0.0125	0.0160	•	•	•	•
Al wrought alloys	≤150 Bhn	850	0.0125	0.0160	•	•	•	•
Al cast alloys ≤ 10 % Si > 10 % Si	≤200 Bhn	770	0.0125	0.0160	•	•	•	•
	≤200 Bhn	635	0.0125	0.0160	•	•	•	•
Magnesium alloys	≤150 Bhn	850	0.0125	0.0160	•	•	•	•
Copper, low-alloyed	≤120 Bhn	340	0.0100	0.0125	•	•	•	•
Brass, short-chipping long-chipping	≤200 Bhn	885	0.0125	0.0160	•	•	•	•
	≤200 Bhn	590	0.0100	0.0125	•	•	•	•
Bronze, short-chipping	≤200 Bhn	340	0.0100	0.0125	•	•	•	•
	>200-260 Bhn	275	0.0100	0.0125	•	•	•	•
Bronze, long-chipping	≤24 Rc	210	0.0100	0.0125	•	•	•	•
	>24-30 Rc	180	0.0080	0.0100	•	•	•	•
Duroplastics	-	340	0.0080	0.0100	•	•	•	•
Thermoplastics	-	340	0.0080	0.0100	•	•	•	•
Reinforced plastics - Kevlar	-	340	0.0080	0.0100	•	•	•	•
Reinforced plastics - GFK / CFK	-	340	0.0080	0.0100	•	•	•	•

$$\text{RPM} = \frac{\text{SFM}}{\text{DIAM. in.}} \times 3.82$$

$$\text{IPM} = \text{IPR} \times \text{RPM}$$

$$\frac{\text{HOLE DEPTH in.}}{\text{IPM}} \times 60 = \text{Cut Time}$$

$$\text{mm} = \text{in.} \times 25.40$$

$$\text{m/min.} = \text{SFM} \div 3.28$$

$$\text{mm/rev.} = \text{IPR} \times 25.40$$

$$\text{Bar} = \text{PSI} \div 14.50$$

$$\text{Liter} = \text{Gal.} \div 3.79$$

Series # 4107 body (3xD) with # 4112 insert

Material group	Hardness	SFM	Feed Rate - IPR										
			1/16 in. 1.590 mm	1/8 in. 3.170 mm	1/4 in. 6.350 mm	3/8 in. 9.520 mm	1/2 in. 12.700mm	5/8 in. 15.870mm	3/4 in. 19.050mm	1 in. 25.400mm	1 1/4 in. 31.75mm	1 1/2 in. 38.10mm	
Nitriding steels	24-30 HRC	345	•	•	•	•	0.008	0.010	0.012	0.016	0.016	0.020	
	30-38 HRC	230	•	•	•	•	0.006	0.008	0.010	0.012	0.012	0.016	
Tool steels	≤ 24 HRC	195	•	•	•	•	0.008	0.010	0.012	0.016	0.016	0.020	
	24-30 HRC	180	•	•	•	•	0.006	0.008	0.010	0.012	0.012	0.016	
High speed steels	14-30 HRC	180	•	•	•	•	0.005	0.006	0.008	0.010	0.010	0.012	
Spring steels	≤ 330 BHN	165	•	•	•	•	0.004	0.005	0.006	0.008	0.008	0.010	
Stainless steels	sulphured austenitic martensitic	≤ 24 HRC	180	•	•	•	•	0.005	0.006	0.008	0.010	0.010	0.012
		≤ 24 HRC	130	•	•	•	•	0.005	0.006	0.008	0.010	0.010	0.012
		≤ 24 HRC	115	•	•	•	•	0.005	0.006	0.008	0.010	0.010	0.012
Hardened steels	40-48 HRC	80	•	•	•	•	0.004	0.005	0.006	0.008	0.008	0.010	
	48-60 HRC	•	•	•	•	•	•	•	•	•	•	•	
Special alloys	≤ 38 HRC	80	•	•	•	•	0.004	0.005	0.006	0.008	0.008	0.010	
Ti and Ti-alloys	≤ 24 HRC	130	•	•	•	•	0.005	0.006	0.008	0.010	0.010	0.012	
	24-38 HRC	115	•	•	•	•	0.004	0.005	0.006	0.008	0.008	0.010	

Series # 4107 body (3xD) with # 4113 insert

Material group	Hardness	SFM	Feed Rate - IPR									
			1/16 in. 1.590 mm	1/8 in. 3.170 mm	1/4 in. 6.350 mm	3/8 in. 9.520 mm	1/2 in. 12.700mm	5/8 in. 15.870mm	3/4 in. 19.050mm	1 in. 25.400mm	1 1/4 in. 31.75mm	1 1/2 in. 38.10mm
Cast iron	≤ 240 BHN	330	•	•	•	•	0.010	0.012	0.016	0.020	0.020	0.025
	240-300 BHN	295	•	•	•	•	0.010	0.012	0.016	0.020	0.020	0.025
New Cast Materials CGI & ADI	220-300 BHN	260	•	•	•	•	0.008	0.010	0.012	0.016	0.016	0.020
New Cast Materials CGI & ADI	350-410 BHN	260	•	•	•	•	0.008	0.010	0.012	0.016	0.016	0.020
Spheroidal graphite iron and malleable cast iron	≤ 240 BHN	395	•	•	•	•	0.012	0.016	0.020	0.025	0.025	0.031
	240-300 BHN	330	•	•	•	•	0.010	0.012	0.016	0.020	0.020	0.025

Series # 4107 body (3xD) with # 4114 insert

Material group	Hardness	SFM	Feed Rate - IPR									
			1/16 in. 1.590 mm	1/8 in. 3.170 mm	1/4 in. 6.350 mm	3/8 in. 9.520 mm	1/2 in. 12.700 mm	5/8 in. 15.870 mm	3/4 in. 19.050 mm	1 in. 25.400 mm	1 1/4 in. 31.750 mm	1 1/2 in. 38.100 mm
Aluminium and Al-alloys	≤120 Bhn	1000	•	•	•	•	0.012	0.016	0.020	0.025	0.025	0.031
Al wrought alloys	≤150 Bhn	1000	•	•	•	•	0.012	0.016	0.020	0.025	0.025	0.031
Al cast alloys ≤ 10 % Si	≤200 Bhn	845	•	•	•	•	0.012	0.016	0.020	0.025	0.025	0.031
	> 10 % Si	710	•	•	•	•	0.012	0.016	0.020	0.025	0.025	0.031
Magnesium alloys	≤150 Bhn	900	•	•	•	•	0.012	0.016	0.020	0.025	0.025	0.031
Copper, low-alloyed	≤120 Bhn	400	•	•	•	•	0.010	0.012	0.016	0.020	0.020	0.025
Brass, short-chipping	≤200 Bhn	1050	•	•	•	•	0.012	0.016	0.020	0.025	0.025	0.031
	long-chipping	710	•	•	•	•	0.010	0.012	0.016	0.020	0.020	0.025
Bronze, short-chipping	≤200 Bhn	410	•	•	•	•	0.010	0.012	0.016	0.020	0.020	0.025
	>200-260 Bhn	345	•	•	•	•	0.010	0.012	0.016	0.020	0.020	0.025
Bronze, long-chipping	≤24 HRC	410	•	•	•	•	0.010	0.012	0.016	0.020	0.020	0.025
	24-30 HRC	345	•	•	•	•	0.008	0.010	0.012	0.016	0.016	0.020

Series # 4107 body (3xD) with # 4115 insert

Material group	Hardness	SFM	Feed Rate - IPR										
			1/16 in. 1.590 mm	1/8 in. 3.170 mm	1/4 in. 6.350 mm	3/8 in. 9.520 mm	1/2 in. 12.700mm	5/8 in. 15.870mm	3/4 in. 19.050mm	1 in. 25.400mm	1 1/4 in. 31.75mm	1 1/2 in. 38.10mm	
Stainless steels	sulphured austenitic martensitic	≤ 24 HRC	180	•	•	•	•	0.005	0.006	0.008	0.010	0.010	0.012
		≤ 24 HRC	130	•	•	•	•	0.005	0.006	0.008	0.010	0.010	0.012
		≤ 24 HRC	115	•	•	•	•	0.005	0.006	0.008	0.010	0.010	0.012
Hardened steels	40-48 HRC	80	•	•	•	•	0.004	0.005	0.006	0.008	0.008	0.010	
	48-60 HRC	•	•	•	•	•	•	•	•	•	•	•	
Special alloys	≤ 38 HRC	80	•	•	•	•	0.004	0.005	0.006	0.008	0.008	0.010	
Chilled cast iron	≤ 350 BHN	295	•	•	•	•	0.010	0.012	0.016	0.020	0.020	0.025	
Ti and Ti-alloys	≤ 24 HRC	130	•	•	•	•	0.005	0.006	0.008	0.010	0.010	0.012	
	24-38 HRC	115	•	•	•	•	0.004	0.005	0.006	0.008	0.008	0.010	

Using These Tables. The Speeds & Feeds listed below are conservative recommendations for initial setup. In actual use, depending on the machining environment and workpiece material, significantly higher speeds and feeds may be achievable. Using the below as a starting point, cutting speed/feed can be gradually adjusted upwards until the optimum settings per application are found. Questions? Contact us by telephone at (800) 776-6170.

Series # 4108 body (5xD) with # 4112 insert

Material group	Hardness	SFM	Feed Rate - IPR										
			1/16 in. 1.590 mm	1/8 in. 3.170 mm	1/4 in. 6.350 mm	3/8 in. 9.520 mm	1/2 in. 12.700mm	5/8 in. 15.870mm	3/4 in. 19.050mm	1 in. 25.400mm	1 1/4 in. 31.75mm	1 1/2 in. 38.10mm	
Common structural steels	≤ 100 BHN	425	•	•	•	•	•	0.010	0.012	0.016	0.020	0.020	0.025
	100-260 BHN	360	•	•	•	•	•	0.008	0.010	0.012	0.016	0.016	0.020
Free-cutting steels	≤ 24 HRC	425	•	•	•	•	•	0.012	0.016	0.020	0.025	0.025	0.031
	24-30 HRC	360	•	•	•	•	•	0.010	0.012	0.016	0.020	0.020	0.025
Unalloyed heat-treatable steels	≤ 16 HRC	425	•	•	•	•	•	0.010	0.012	0.016	0.020	0.020	0.025
	16-24 HRC	410	•	•	•	•	•	0.010	0.012	0.016	0.020	0.020	0.025
	24-30 HRC	360	•	•	•	•	•	0.008	0.010	0.012	0.016	0.016	0.020
Alloyed heat-treatable steels	24-30 HRC	360	•	•	•	•	•	0.010	0.012	0.016	0.020	0.020	0.025
	30-38 HRC	295	•	•	•	•	•	0.008	0.010	0.012	0.016	0.016	0.020
Unalloyed case hardened steels	≤ 230 BHN	425	•	•	•	•	•	0.012	0.016	0.020	0.025	0.025	0.031
Alloyed case hardened steels	24-30 HRC	360	•	•	•	•	•	0.010	0.012	0.016	0.020	0.020	0.025
	30-38 HRC	230	•	•	•	•	•	0.006	0.008	0.010	0.012	0.012	0.016
Nitriding steels	24-30 HRC	345	•	•	•	•	•	0.008	0.010	0.012	0.016	0.016	0.020
	30-38 HRC	230	•	•	•	•	•	0.006	0.008	0.010	0.012	0.012	0.016
Tool steels	≤ 24 HRC	195	•	•	•	•	•	0.008	0.010	0.012	0.016	0.016	0.020
	24-30 HRC	180	•	•	•	•	•	0.006	0.008	0.010	0.012	0.012	0.016
High speed steels	14-30 HRC	180	•	•	•	•	•	0.005	0.006	0.008	0.010	0.010	0.012
Spring steels	≤ 330 BHN	165	•	•	•	•	•	0.004	0.005	0.006	0.008	0.008	0.010
Stainless steels	≤ 24 HRC	180	•	•	•	•	•	0.005	0.006	0.008	0.010	0.010	0.012
	24 HRC	130	•	•	•	•	•	0.005	0.006	0.008	0.010	0.010	0.012
	≤ 24 HRC	115	•	•	•	•	•	0.005	0.006	0.008	0.010	0.010	0.012
Hardened steels	40-48 HRC	80	•	•	•	•	•	0.004	0.005	0.006	0.008	0.008	0.010
	48-60 HRC	•	•	•	•	•	•	•	•	•	•	•	•
Special alloys	≤ 38 HRC	80	•	•	•	•	•	0.004	0.005	0.006	0.008	0.008	0.010
Ti and Ti-alloys	≤ 24 HRC	130	•	•	•	•	•	0.005	0.006	0.008	0.010	0.010	0.012
	24-38 HRC	115	•	•	•	•	•	0.004	0.005	0.006	0.008	0.008	0.010

Series # 4108 body (5xD) with # 4113 insert

Material group	Hardness	SFM	Feed Rate - IPR										
			1/16 in. 1.590 mm	1/8 in. 3.170 mm	1/4 in. 6.350 mm	3/8 in. 9.520 mm	1/2 in. 12.700 mm	5/8 in. 15.870 mm	3/4 in. 19.050 mm	1 in. 25.400 mm	1 1/4 in. 31.750 mm	1 1/2 in. 38.100 mm	
Cast iron	≤240 Bhn	330	•	•	•	•	•	0.010	0.012	0.016	0.020	0.020	0.025
	240-300 Bhn	295	•	•	•	•	•	0.010	0.012	0.016	0.020	0.020	0.025
New Cast Materials CGI & ADI	350-410 Bhn	260	•	•	•	•	•	0.008	0.010	0.012	0.016	0.016	0.020
New Cast Materials CGI & ADI	350-410 Bhn	260	•	•	•	•	•	0.008	0.010	0.012	0.016	0.016	0.020
Spheroidal graphite iron and malleable cast iron	≤240 Bhn	395	•	•	•	•	•	0.012	0.016	0.020	0.025	0.025	0.031
	240-300 Bhn	330	•	•	•	•	•	0.010	0.012	0.016	0.020	0.020	0.025

Series # 4108 body (5xD) with # 4114 insert

Material group	Hardness	SFM	Feed Rate - IPR										
			1/16 in. 1.590 mm	1/8 in. 3.170 mm	1/4 in. 6.350 mm	3/8 in. 9.520 mm	1/2 in. 12.700 mm	5/8 in. 15.870 mm	3/4 in. 19.050 mm	1 in. 25.400 mm	1 1/4 in. 31.750 mm	1 1/2 in. 38.100 mm	
Aluminium and Al-alloys	≤120 Bhn	655	•	•	•	•	•	0.012	0.016	0.020	0.025	0.025	0.031
Al wrought alloys	≤150 Bhn	590	•	•	•	•	•	0.012	0.016	0.020	0.025	0.025	0.031
Al cast alloys ≤ 10 % Si	≤200 Bhn	490	•	•	•	•	•	0.012	0.016	0.020	0.025	0.025	0.031
	> 10 % Si	395	•	•	•	•	•	0.012	0.016	0.020	0.025	0.025	0.031
Magnesium alloys	≤150 Bhn	590	•	•	•	•	•	0.012	0.016	0.020	0.025	0.025	0.031
Copper, low-alloyed	≤120 Bhn	230	•	•	•	•	•	0.010	0.012	0.016	0.020	0.020	0.025
Brass, short-chipping	≤200 Bhn	590	•	•	•	•	•	0.012	0.016	0.020	0.025	0.025	0.031
	long-chipping	≤200 Bhn	395	•	•	•	•	•	0.010	0.012	0.016	0.020	0.020
Bronze, short-chipping	≤200 Bhn	230	•	•	•	•	•	0.010	0.012	0.016	0.020	0.020	0.025
	>200-260 Bhn	165	•	•	•	•	•	0.010	0.012	0.016	0.020	0.020	0.025
Bronze, long-chipping	24 Hrc	150	•	•	•	•	•	0.010	0.012	0.016	0.020	0.020	0.025
	24-30 Hrc	115	•	•	•	•	•	0.008	0.010	0.012	0.016	0.016	0.020

Series # 4108 body (5xD) with # 4115 insert

Material group	Hardness	SFM	Feed Rate - IPR										
			1/16 in. 1.590 mm	1/8 in. 3.170 mm	1/4 in. 6.350 mm	3/8 in. 9.520 mm	1/2 in. 12.700mm	5/8 in. 15.870mm	3/4 in. 19.050mm	1 in. 25.400mm	1 1/4 in. 31.75mm	1 1/2 in. 38.10mm	
Stainless steels	≤ 24 HRC	180	•	•	•	•	•	0.005	0.006	0.008	0.010	0.010	0.012
	24 HRC	130	•	•	•	•	•	0.005	0.006	0.008	0.010	0.010	0.012
	≤ 24 HRC	115	•	•	•	•	•	0.005	0.006	0.008	0.010	0.010	0.012
Hardened steels	40-48 HRC	80	•	•	•	•	•	0.004	0.005	0.006	0.008	0.008	0.010
	48-60 HRC	•	•	•	•	•	•	•	•	•	•	•	•
Special alloys	≤ 38 HRC	80	•	•	•	•	•	0.004	0.005	0.006	0.008	0.008	0.010
Chilled cast iron	≤ 350 BHN	295	•	•	•	•	•	0.010	0.012	0.016	0.020	0.020	0.025
Ti and Ti-alloys	≤ 24 HRC	130	•	•	•	•	•	0.005	0.006	0.008	0.010	0.010	0.012
	24-38 HRC	115	•	•	•	•	•	0.004	0.005	0.006	0.008	0.008	0.010

$$\text{RPM} = \frac{\text{SFM}}{\text{DIAM. in.}} \times 3.82$$

$$\text{IPM} = \text{IPR} \times \text{RPM}$$

$$\frac{\text{HOLE DEPTH in.}}{\text{IPM}} \times 60 = \text{Cut Time}$$

$$\text{mm} = \text{in.} \times 25.40$$

$$\text{m/min.} = \text{SFM} \div 3.28$$

$$\text{mm/rev.} = \text{IPR} \times 25.40$$

$$\text{Bar} = \text{PSI} \div 14.50$$

$$\text{Liter} = \text{Gal.} \div 3.79$$

Series # 4109 body (7xD) with # 4112 insert

Material group	Hardness	SFM	Feed Rate - IPR										
			1/16 in. 1.590 mm	1/8 in. 3.170 mm	1/4 in. 6.350 mm	3/8 in. 9.520 mm	1/2 in. 12.700mm	5/8 in. 15.870mm	3/4 in. 19.050mm	1 in. 25.400mm	1 1/4 in. 31.75mm	1 1/2 in. 38.10mm	
Nitriding steels	24-30 HRC	345	*	*	*	*	0.160	0.200	0.250	0.315	0.315	0.400	
	30-38 HRC	230	*	*	*	*	0.125	0.160	0.200	0.250	0.250	0.315	
Tool steels	≤ 24 HRC	195	*	*	*	*	0.160	0.200	0.250	0.315	0.315	0.400	
	24-30 HRC	180	*	*	*	*	0.125	0.160	0.200	0.250	0.250	0.315	
High speed steels	14-30 HRC	180	*	*	*	*	0.100	0.125	0.160	0.200	0.200	0.250	
Spring steels	≤ 330 BHN	165	*	*	*	*	0.100	0.125	0.160	0.200	0.200	0.250	
Stainless steels	sulphured austenitic martensitic	≤ 24 HRC	180	*	*	*	*	0.100	0.125	0.160	0.200	0.200	0.250
		≤ 24 HRC	130	*	*	*	*	0.100	0.125	0.160	0.200	0.200	0.250
		≤ 24 HRC	115	*	*	*	*	0.100	0.125	0.160	0.200	0.200	0.250
Hardened steels	40-48 HRC	80	*	*	*	*	0.080	0.100	0.125	0.160	0.160	0.200	
	48-60 HRC	*	*	*	*	*	*	*	*	*	*	*	
Special alloys	≤ 38 HRC	80	*	*	*	*	0.080	0.100	0.125	0.160	0.160	0.200	
Ti and Ti-alloys	≤ 24 HRC	130	*	*	*	*	0.100	0.125	0.160	0.200	0.200	0.250	
	24-38 HRC	115	*	*	*	*	0.080	0.100	0.125	0.160	0.160	0.200	

Series # 4109 body (7xD) with # 4113 insert

Material group	Hardness	SFM	Feed Rate - IPR									
			1/16 in. 1.590 mm	1/8 in. 3.170 mm	1/4 in. 6.350 mm	3/8 in. 9.520 mm	1/2 in. 12.700 mm	5/8 in. 15.870 mm	3/4 in. 19.050 mm	1 in. 25.400 mm	1 1/4 in. 31.750 mm	1 1/2 in. 38.100 mm
Cast iron	≤240 Bhn	330	*	*	*	*	0.010	0.012	0.016	0.020	0.020	0.025
	240-300 Bhn	295	*	*	*	*	0.010	0.012	0.016	0.020	0.020	0.025
New Cast Materials CGI & ADI	350-410 Bhn	260	*	*	*	*	0.008	0.010	0.012	0.016	0.016	0.020
New Cast Materials CGI & ADI	350-410 Bhn	260	*	*	*	*	0.008	0.010	0.012	0.016	0.016	0.020
Spheroidal graphite iron and malleable cast iron	≤240 Bhn	395	*	*	*	*	0.012	0.016	0.020	0.025	0.025	0.031
	240-300 Bhn	330	*	*	*	*	0.010	0.012	0.016	0.020	0.020	0.025

Series # 4109 body (7xD) with # 4114 insert

Material group	Hardness	SFM	Feed Rate - IPR									
			1/16 in. 1.590 mm	1/8 in. 3.170 mm	1/4 in. 6.350 mm	3/8 in. 9.520 mm	1/2 in. 12.700 mm	5/8 in. 15.870 mm	3/4 in. 19.050 mm	1 in. 25.400 mm	1 1/4 in. 31.750 mm	1 1/2 in. 38.100 mm
Aluminium and Al-alloys	≤120 Bhn	655	*	*	*	*	0.010	0.012	0.016	0.020	0.020	0.025
Al wrought alloys	≤150 Bhn	590	*	*	*	*	0.010	0.012	0.016	0.020	0.020	0.025
Al cast alloys	≤ 10 % Si	490	*	*	*	*	0.010	0.012	0.016	0.020	0.020	0.025
	> 10 % Si	395	*	*	*	*	0.010	0.012	0.016	0.020	0.020	0.025
Magnesium alloys	≤150 Bhn	590	*	*	*	*	0.010	0.012	0.016	0.020	0.020	0.025
Copper, low-alloyed	≤120 Bhn	230	*	*	*	*	0.008	0.010	0.012	0.016	0.016	0.020
Brass, short-chipping	≤200 Bhn	590	*	*	*	*	0.010	0.012	0.016	0.020	0.020	0.025
	≤200 Bhn	395	*	*	*	*	0.008	0.010	0.012	0.016	0.016	0.020
Bronze, short-chipping	≤200 Bhn	230	*	*	*	*	0.008	0.010	0.012	0.016	0.016	0.020
	>200-260 Bhn	165	*	*	*	*	0.008	0.010	0.012	0.016	0.016	0.020
Bronze, long-chipping	24 Hrc	150	*	*	*	*	0.008	0.010	0.012	0.016	0.016	0.020
	24-30 Hrc	115	*	*	*	*	0.006	0.008	0.010	0.012	0.012	0.016

Series # 4109 body (7xD) with # 4115 insert

Material group	Hardness	SFM	Feed Rate - IPR										
			1/16 in. 1.590 mm	1/8 in. 3.170 mm	1/4 in. 6.350 mm	3/8 in. 9.520 mm	1/2 in. 12.700mm	5/8 in. 15.870mm	3/4 in. 19.050mm	1 in. 25.400mm	1 1/4 in. 31.75mm	1 1/2 in. 38.10mm	
Stainless steels	sulphured austenitic martensitic	≤ 24 HRC	180	*	*	*	*	0.004	0.005	0.006	0.008	0.008	0.010
		≤ 24 HRC	130	*	*	*	*	0.004	0.005	0.006	0.008	0.008	0.010
		≤ 24 HRC	115	*	*	*	*	0.004	0.005	0.006	0.008	0.008	0.010
Hardened steels	40-48 HRC	80	*	*	*	*	0.003	0.004	0.005	0.006	0.006	0.008	
	48-60 HRC	*	*	*	*	*	*	*	*	*	*	*	
Special alloys	≤ 38 HRC	80	*	*	*	*	0.003	0.004	0.005	0.006	0.006	0.008	
Chilled cast iron	≤ 350 BHN	295	*	*	*	*	0.010	0.012	0.016	0.020	0.020	0.025	
Ti and Ti-alloys	≤ 24 HRC	130	*	*	*	*	0.004	0.005	0.006	0.008	0.008	0.010	
	24-38 HRC	115	*	*	*	*	0.003	0.004	0.005	0.006	0.006	0.008	

Using These Tables. The Speeds & Feeds listed below are conservative recommendations for initial setup. In actual use, depending on the machining environment and workpiece material, significantly higher speeds and feeds may be achievable. Using the below as a starting point, cutting speed/feed can be gradually adjusted upwards until the optimum settings per application are found. Questions? Contact us by telephone at (800) 776-6170.

Series # 4110 body (10xD) with # 4112 insert

Material group	Hardness	SFM	Feed Rate - IPR										
			1/16 in. 1.590 mm	1/8 in. 3.170 mm	1/4 in. 6.350 mm	3/8 in. 9.520 mm	1/2 in. 12.700mm	5/8 in. 15.870mm	3/4 in. 19.050mm	1 in. 25.400mm	1 1/4 in. 31.75mm	1 1/2 in. 38.10mm	
Common structural steels	≤ 100 BHN	425	•	•	•	•	•	0.200	0.250	0.315	0.400	0.400	0.500
	100-260 BHN	360	•	•	•	•	•	0.160	0.200	0.250	0.315	0.315	0.400
Free-cutting steels	≤ 24 HRC	425	•	•	•	•	•	0.250	0.315	0.400	0.500	0.500	0.630
	24-30 HRC	360	•	•	•	•	•	0.200	0.250	0.315	0.400	0.400	0.500
Unalloyed heat-treatable steels	≤ 16 HRC	425	•	•	•	•	•	0.200	0.250	0.315	0.400	0.400	0.500
	16-24 HRC	410	•	•	•	•	•	0.200	0.250	0.315	0.400	0.400	0.500
	24-30 HRC	360	•	•	•	•	•	0.160	0.200	0.250	0.315	0.315	0.400
Alloyed heat-treatable steels	24-30 HRC	360	•	•	•	•	•	0.200	0.250	0.315	0.400	0.400	0.500
	30-38 HRC	295	•	•	•	•	•	0.160	0.200	0.250	0.315	0.315	0.400
Unalloyed case hardened steels	≤ 230 BHN	425	•	•	•	•	•	0.250	0.315	0.400	0.500	0.500	0.630
Alloyed case hardened steels	24-30 HRC	360	•	•	•	•	•	0.200	0.250	0.315	0.400	0.400	0.500
	30-38 HRC	230	•	•	•	•	•	0.160	0.200	0.250	0.315	0.315	0.400
Nitriding steels	24-30 HRC	345	•	•	•	•	•	0.160	0.200	0.250	0.315	0.315	0.400
	30-38 HRC	230	•	•	•	•	•	0.125	0.160	0.200	0.250	0.250	0.315
Tool steels	≤ 24 HRC	195	•	•	•	•	•	0.160	0.200	0.250	0.315	0.315	0.400
	24-30 HRC	180	•	•	•	•	•	0.125	0.160	0.200	0.250	0.250	0.315
High speed steels	14-30 HRC	180	•	•	•	•	•	0.100	0.125	0.160	0.200	0.200	0.250
Spring steels	≤ 330 BHN	165	•	•	•	•	•	0.100	0.125	0.160	0.200	0.200	0.250
Stainless steels	≤ 24 HRC	180	•	•	•	•	•	0.100	0.125	0.160	0.200	0.200	0.250
	24 HRC	130	•	•	•	•	•	0.100	0.125	0.160	0.200	0.200	0.250
	24 HRC	115	•	•	•	•	•	0.100	0.125	0.160	0.200	0.200	0.250
Hardened steels	40-48 HRC	80	•	•	•	•	•	0.080	0.100	0.125	0.160	0.160	0.200
	48-60 HRC	•	•	•	•	•	•	•	•	•	•	•	•
Special alloys	≤ 38 HRC	80	•	•	•	•	•	0.080	0.100	0.125	0.160	0.160	0.200
Ti and Ti-alloys	≤ 24 HRC	130	•	•	•	•	•	0.100	0.125	0.160	0.200	0.200	0.250
	24-38 HRC	115	•	•	•	•	•	0.080	0.100	0.125	0.160	0.160	0.200

Series # 4110 body (10xD) with # 4113 insert

Material group	Hardness	SFM	Feed Rate - IPR										
			1/16 in. 1.590 mm	1/8 in. 3.170 mm	1/4 in. 6.350 mm	3/8 in. 9.520 mm	1/2 in. 12.700 mm	5/8 in. 15.870 mm	3/4 in. 19.050 mm	1 in. 25.400 mm	1 1/4 in. 31.750 mm	1 1/2 in. 38.100 mm	
Cast iron	≤240 Bhn	330	•	•	•	•	•	0.010	0.012	0.016	0.020	0.020	0.025
	240-300 Bhn	295	•	•	•	•	•	0.010	0.012	0.016	0.020	0.020	0.025
New Cast Materials CGI & ADI	350-410 Bhn	260	•	•	•	•	•	0.008	0.010	0.012	0.016	0.016	0.020
New Cast Materials CGI & ADI	350-410 Bhn	260	•	•	•	•	•	0.008	0.010	0.012	0.016	0.016	0.020
Spheroidal graphite iron and malleable cast iron	≤240 Bhn	395	•	•	•	•	•	0.012	0.016	0.020	0.025	0.025	0.031
	240-300 Bhn	330	•	•	•	•	•	0.010	0.012	0.016	0.020	0.020	0.025

Series # 4110 body (10xD) with # 4114 insert

Material group	Hardness	SFM	Feed Rate - IPR										
			1/16 in. 1.590 mm	1/8 in. 3.170 mm	1/4 in. 6.350 mm	3/8 in. 9.520 mm	1/2 in. 12.700 mm	5/8 in. 15.870 mm	3/4 in. 19.050 mm	1 in. 25.400 mm	1 1/4 in. 31.750 mm	1 1/2 in. 38.100 mm	
Aluminium and Al-alloys	≤120 Bhn	655	•	•	•	•	•	0.012	0.016	0.020	0.025	0.025	0.031
Al wrought alloys	≤150 Bhn	590	•	•	•	•	•	0.012	0.016	0.020	0.025	0.025	0.031
Al cast alloys ≤ 10 % Si	≤200 Bhn	490	•	•	•	•	•	0.012	0.016	0.020	0.025	0.025	0.031
	> 10 % Si	395	•	•	•	•	•	0.012	0.016	0.020	0.025	0.025	0.031
Magnesium alloys	≤150 Bhn	590	•	•	•	•	•	0.012	0.016	0.020	0.025	0.025	0.031
Copper, low-alloyed	≤120 Bhn	230	•	•	•	•	•	0.010	0.012	0.016	0.020	0.020	0.025
Brass, short-chipping	≤200 Bhn	590	•	•	•	•	•	0.012	0.016	0.020	0.025	0.025	0.031
	long-chipping	≤200 Bhn	395	•	•	•	•	•	0.010	0.012	0.016	0.020	0.020
Bronze, short-chipping	≤200 Bhn	230	•	•	•	•	•	0.010	0.012	0.016	0.020	0.020	0.025
	>200-260 Bhn	165	•	•	•	•	•	0.010	0.012	0.016	0.020	0.020	0.025
Bronze, long-chipping	24 Hrc	150	•	•	•	•	•	0.010	0.012	0.016	0.020	0.020	0.025
	24-30 Hrc	115	•	•	•	•	•	0.008	0.010	0.012	0.016	0.016	0.020

Series # 4110 body (10xD) with # 4115 insert

Material group	Hardness	SFM	Feed Rate - IPR										
			1/16 in. 1.590 mm	1/8 in. 3.170 mm	1/4 in. 6.350 mm	3/8 in. 9.520 mm	1/2 in. 12.700mm	5/8 in. 15.870mm	3/4 in. 19.050mm	1 in. 25.400mm	1 1/4 in. 31.75mm	1 1/2 in. 38.10mm	
Stainless steels	≤ 24 HRC	180	•	•	•	•	•	0.005	0.006	0.008	0.010	0.010	0.012
	24 HRC	130	•	•	•	•	•	0.005	0.006	0.008	0.010	0.010	0.012
	24 HRC	115	•	•	•	•	•	0.005	0.006	0.008	0.010	0.010	0.012
Hardened steels	40-48 HRC	80	•	•	•	•	•	0.004	0.005	0.006	0.008	0.008	0.010
	48-60 HRC	•	•	•	•	•	•	•	•	•	•	•	•
Special alloys	≤ 38 HRC	80	•	•	•	•	•	0.004	0.005	0.006	0.008	0.008	0.010
Chilled cast iron	≤ 350 BHN	295	•	•	•	•	•	0.010	0.012	0.016	0.020	0.020	0.025
Ti and Ti-alloys	≤ 24 HRC	130	•	•	•	•	•	0.005	0.006	0.008	0.010	0.010	0.012
	24-38 HRC	115	•	•	•	•	•	0.004	0.005	0.006	0.008	0.008	0.010

$$\text{RPM} = \frac{\text{SFM}}{\text{DIAM. in.}} \times 3.82 \quad \text{IPM} = \text{IPR} \times \text{RPM}$$

$$\frac{\text{HOLE DEPTH in.}}{\text{IPM}} \times 60 = \text{Cut Time}$$

$$\text{mm} = \text{in.} \times 25.40$$

$$\text{m/min.} = \text{SFM} \div 3.28$$

$$\text{Bar} = \text{PSI} \div 14.50$$

$$\text{mm/rev.} = \text{IPR} \times 25.40$$

$$\text{Liter} = \text{Gal.} \div 3.79$$

Series # 4044

Material group	Hardness	SFM	Feed Rate - IPR										
			1/16 in. 1.590 mm	1/8 in. 3.170 mm	1/4 in. 6.350 mm	3/8 in. 9.520 mm	1/2 in. 12.700 mm	5/8 in. 15.870 mm	3/4 in. 19.050 mm	1 in. 25.400 mm	1 1/4 in. 31.750 mm	1 1/2 in. 38.100 mm	
Common structural steels	≤100 Bhn	460	•	0.0050	0.0080	0.0100	0.0125	0.0125	0.0140	0.0160	•	•	
	>100-260 Bhn	395	•	0.0040	0.0065	0.0080	0.0100	0.0100	0.0110	0.0125	•	•	
Free-cutting steels	≤24 Rc	550	•	0.0065	0.0100	0.0125	0.0160	0.0160	0.0180	0.0200	•	•	
	>24-30 Rc	480	•	0.0065	0.0100	0.0125	0.0160	0.0160	0.0180	0.0200	•	•	
Unalloyed heat-treatable steels	≤16 Rc	415	•	0.0065	0.0100	0.0125	0.0160	0.0160	0.0180	0.0200	•	•	
	16-24 Rc	400	•	0.0050	0.0080	0.0100	0.0125	0.0125	0.0140	0.0160	•	•	
	24-30 Rc	395	•	0.0050	0.0080	0.0100	0.0125	0.0125	0.0140	0.0160	•	•	
Alloyed heat-treatable steels	24-30 Rc	395	•	0.0050	0.0080	0.0100	0.0125	0.0125	0.0140	0.0160	•	•	
	>30-38 Rc	335	•	0.0050	0.0080	0.0100	0.0125	0.0125	0.0140	0.0160	•	•	
Unalloyed case hardened steels	≤230 Bhn	465	•	0.0065	0.0100	0.0125	0.0160	0.0160	0.0180	0.0200	•	•	
Alloyed case hardened steels	24-30 Rc	395	•	0.0050	0.0080	0.0100	0.0125	0.0125	0.0140	0.0160	•	•	
	>30-38 Rc	270	•	0.0030	0.0050	0.0065	0.0080	0.0080	0.0090	0.0100	•	•	
Nitriding steels	≥24-30 Rc	340	•	0.0050	0.0080	0.0100	0.0125	0.0125	0.0140	0.0160	•	•	
	>30-38 Rc	325	•	0.0040	0.0065	0.0080	0.0100	0.0100	0.0110	0.0125	•	•	
Tool steels	≤24 Rc	230	•	0.0040	0.0065	0.0080	0.0100	0.0100	0.0110	0.0125	•	•	
	>24-30 Rc	175	•	0.0030	0.0050	0.0065	0.0080	0.0080	0.0090	0.0100	•	•	
High speed steels	≥14-30 Rc	195	•	0.0025	0.0040	0.0050	0.0065	0.0065	0.0070	0.0080	•	•	
Spring steels	≤330 Bhn	195	•	0.0020	0.0030	0.0040	0.0050	0.0050	0.0055	0.0065	•	•	
Stainless steels, sulphured	≤24 Rc	195	•	0.0030	0.0050	0.0065	0.0080	0.0080	0.0090	0.0100	•	•	
	austenitic	≤24 Rc	175	•	0.0030	0.0050	0.0065	0.0080	0.0080	0.0090	0.0100	•	•
	martensitic	≤24 Rc	155	•	0.0030	0.0050	0.0065	0.0080	0.0080	0.0090	0.0100	•	•
Hardened steels	≤40-48 Rc	175	•	0.0020	0.0030	0.0040	0.0050	0.0050	0.0055	0.0065	•	•	
	>48-60 Rc	110	•	0.0020	0.0030	0.0040	0.0050	0.0050	0.0055	0.0065	•	•	
Special alloys	≤38 Rc	110	•	0.0025	0.0040	0.0050	0.0065	0.0065	0.0070	0.0080	•	•	
Cast iron	≤240 Bhn	640	•	0.0080	0.0125	0.0160	0.0200	0.0200	0.0220	0.0245	•	•	
	<300 Bhn	525	•	0.0080	0.0125	0.0160	0.0200	0.0200	0.0220	0.0245	•	•	
Spheroidal graphite iron and malleable cast iron	≤240 Bhn	435	•	0.0080	0.0125	0.0160	0.0200	0.0200	0.0220	0.0245	•	•	
	<300 Bhn	415	•	0.0065	0.0100	0.0125	0.0160	0.0160	0.0180	0.0200	•	•	
Chilled cast iron	≤350 Bhn	130	•	0.0020	0.0030	0.0040	0.0050	0.0050	0.0055	0.0065	•	•	
Ti and Ti-alloys	≤24 Rc	140	•	0.0020	0.0030	0.0040	0.0050	0.0050	0.0055	0.0065	•	•	
	>24-38 Rc	130	•	0.0020	0.0030	0.0040	0.0050	0.0050	0.0055	0.0065	•	•	
Aluminium and Al-alloys	≤120 Bhn	1000	•	0.0080	0.0125	0.0160	0.0200	0.0200	0.0220	0.0245	•	•	
Al wrought alloys	≤150 Bhn	1000	•	0.0080	0.0125	0.0160	0.0200	0.0200	0.0220	0.0245	•	•	
Al cast alloys ≤ 10 % Si	≤200 Bhn	845	•	0.0080	0.0125	0.0160	0.0200	0.0200	0.0220	0.0245	•	•	
	> 10 % Si	710	•	0.0080	0.0125	0.0160	0.0200	0.0200	0.0220	0.0245	•	•	
Magnesium alloys	≤150 Bhn	900	•	0.0065	0.0100	0.0125	0.0160	0.0160	0.0180	0.0200	•	•	
Copper, low-alloyed	≤120 Bhn	400	•	0.0065	0.0100	0.0125	0.0160	0.0160	0.0180	0.0200	•	•	
Brass, short-chipping	≤200 Bhn	1050	•	0.0080	0.0125	0.0160	0.0200	0.0200	0.0220	0.0245	•	•	
	long-chipping	≤200 Bhn	710	•	0.0065	0.0100	0.0125	0.0160	0.0160	0.0180	0.0200	•	•
Bronze, short-chipping	≤200 Bhn	410	•	0.0065	0.0100	0.0125	0.0160	0.0160	0.0180	0.0200	•	•	
	>200-260 Bhn	345	•	0.0050	0.0080	0.0100	0.0125	0.0125	0.0140	0.0160	•	•	
Bronze, long-chipping	≤24 Rc	285	•	0.0050	0.0080	0.0100	0.0125	0.0125	0.0140	0.0160	•	•	
	>24-30 Rc	250	•	0.0050	0.0080	0.0100	0.0125	0.0125	0.0140	0.0160	•	•	
Duroplastics	-	•	•	•	•	•	•	•	•	•	•	•	
Thermoplastics	-	•	•	•	•	•	•	•	•	•	•	•	
Reinforced plastics - Kevlar	-	•	•	•	•	•	•	•	•	•	•	•	
Reinforced plastics - GFK / CFK	-	•	•	•	•	•	•	•	•	•	•	•	

Series # 5020, 5021, 5024, 5026 - EB100 Less than 35xD

Material group	Hardness	SFM	Feed Rate - IPR									
			1/16 in. 1.590 mm	1/8 in. 3.170 mm	1/4 in. 6.350 mm	3/8 in. 9.520 mm	1/2 in. 12.700 mm	5/8 in. 15.870 mm	3/4 in. 19.050 mm	1 in. 25.400 mm	1 1/4 in. 31.750 mm	1 1/2 in. 38.100 mm
Common structural steels	≤100 Bhn >100-260 Bhn	330 280	0.0003 0.0003	0.0006 0.0006	0.0009 0.0009	0.0015 0.0015	•	•	•	•	•	•
Free-cutting steels	≤24 Rc >24-30 Rc	295 260	0.0003 0.0003	0.0006 0.0006	0.0009 0.0009	0.0015 0.0015	•	•	•	•	•	•
Unalloyed heat-treatable steels	≤16 Rc 16-24 Rc 24-30 Rc	295 260 245	0.0002 0.0002 0.0002	0.0004 0.0004 0.0004	0.0005 0.0005 0.0005	0.0010 0.0010 0.0010	•	•	•	•	•	•
Alloyed heat-treatable steels	24-30 Rc >30-38 Rc	245 215	0.0002 0.0002	0.0004 0.0004	0.0005 0.0005	0.0010 0.0010	•	•	•	•	•	•
Unalloyed case hardened steels	≤230 Bhn	260	0.0003	0.0006	0.0009	0.0015	•	•	•	•	•	•
Alloyed case hardened steels	24-30 Rc >30-38 Rc	245 215	0.0002 0.0002	0.0004 0.0004	0.0005 0.0005	0.0010 0.0010	•	•	•	•	•	•
Nitriding steels	≥24-30 Rc >30-38 Rc	245 215	0.0002 0.0002	0.0004 0.0004	0.0005 0.0005	0.0010 0.0010	•	•	•	•	•	•
Tool steels	≤24 Rc >24-30 Rc	245 215	0.0002 0.0002	0.0003 0.0003	0.0004 0.0004	0.0006 0.0006	•	•	•	•	•	•
High speed steels	≥14-30 Rc	180	0.0001	0.0002	0.0003	0.0004	•	•	•	•	•	•
Spring steels	≤330 Bhn	215	0.0002	0.0003	0.0003	0.0006	•	•	•	•	•	•
Stainless steels, sulphured austenitic martensitic	≤24 Rc ≤24 Rc ≤24 Rc	180 150 115	0.0002 0.0002 0.0002	0.0004 0.0004 0.0004	0.0005 0.0005 0.0005	0.0010 0.0010 0.0010	•	•	•	•	•	•
Hardened steels	≤40-48 Rc >48-60 Rc	100 80	0.0002 0.0001	0.0003 0.0002	0.0004 0.0003	0.0006 0.0004	•	•	•	•	•	•
Special alloys	≤38 Rc	115	0.0001	0.0002	0.0003	0.0004	•	•	•	•	•	•
Cast iron	≤240 Bhn <300 Bhn	280 260	0.0005 0.0005	0.0009 0.0009	0.0014 0.0014	0.0020 0.0020	•	•	•	•	•	•
Spheroidal graphite iron and malleable cast iron	≤240 Bhn <300 Bhn	260 230	0.0003 0.0003	0.0006 0.0006	0.0009 0.0009	0.0015 0.0015	•	•	•	•	•	•
Chilled cast iron	≤350 Bhn	180	0.0002	0.0004	0.0005	0.0010	•	•	•	•	•	•
Ti and Ti-alloys	≤24 Rc >24-38 Rc	115 100	0.0001 0.0001	0.0002 0.0002	0.0003 0.0003	0.0004 0.0004	•	•	•	•	•	•
Aluminium and Al-alloys	≤120 Bhn	490	0.0008	0.0016	0.0024	0.0028	•	•	•	•	•	•
Al wrought alloys	≤150 Bhn	395	0.0008	0.0016	0.0024	0.0028	•	•	•	•	•	•
Al cast alloys ≤ 10 % Si > 10 % Si	≤200 Bhn ≤200 Bhn	490 425	0.0013 0.0013	0.0024 0.0024	0.0033 0.0033	0.0047 0.0047	•	•	•	•	•	•
Magnesium alloys	≤150 Bhn	360	0.0008	0.0016	0.0024	0.0028	•	•	•	•	•	•
Copper, low-alloyed	≤120 Bhn	245	0.0003	0.0006	0.0009	0.0015	•	•	•	•	•	•
Brass, short-chipping long-chipping	≤200 Bhn ≤200 Bhn	395 295	0.0013 0.0013	0.0024 0.0024	0.0033 0.0033	0.0047 0.0047	•	•	•	•	•	•
Bronze, short-chipping	≤200 Bhn >200-260 Bhn	310 310	0.0008 0.0008	0.0016 0.0016	0.0024 0.0024	0.0028 0.0028	•	•	•	•	•	•
Bronze, long-chipping	≤24 Rc >24-30 Rc	230 230	0.0008 0.0008	0.0016 0.0016	0.0024 0.0024	0.0028 0.0028	•	•	•	•	•	•
Duroplastics	-	245	0.0003	0.0006	0.0009	0.0015	•	•	•	•	•	•
Thermoplastics	-	230	0.0003	0.0006	0.0009	0.0015	•	•	•	•	•	•
Reinforced plastics - Kevlar	-	195	0.0002	0.0004	0.0005	0.0010	•	•	•	•	•	•
Reinforced plastics - GFK / CFK	-	165	0.0002	0.0004	0.0005	0.0010	•	•	•	•	•	•

Series # 5020, 5021, 5024, 5026 - EB100 Greater than 35xD

Material group	Hardness	SFM	Feed Rate - IPR									
			1/16 in. 1.590 mm	1/8 in. 3.170 mm	1/4 in. 6.350 mm	3/8 in. 9.520 mm	1/2 in. 12.700 mm	5/8 in. 15.870 mm	3/4 in. 19.050 mm	1 in. 25.400 mm	1 1/4 in. 31.750 mm	1 1/2 in. 38.100 mm
Common structural steels	≤100 Bhn >100-260 Bhn	310 260	0.00024 0.00024	0.00035 0.00035	0.00051 0.00051	0.00098 0.00098	•	•	•	•	•	•
Free-cutting steels	≤24 Rc >24-30 Rc	280 245	0.00024 0.00024	0.00035 0.00035	0.00051 0.00051	0.00098 0.00098	•	•	•	•	•	•
Unalloyed heat-treatable steels	≤16 Rc 16-24 Rc 24-30 Rc	280 245 230	0.00016 0.00016 0.00016	0.00026 0.00026 0.00026	0.00035 0.00035 0.00035	0.00059 0.00059 0.00059	•	•	•	•	•	•
Alloyed heat-treatable steels	24-30 Rc >30-38 Rc	230 195	0.00016 0.00016	0.00026 0.00026	0.00035 0.00035	0.00059 0.00059	•	•	•	•	•	•
Unalloyed case hardened steels	≤230 Bhn	245	0.00024	0.00035	0.00051	0.00098	•	•	•	•	•	•
Alloyed case hardened steels	24-30 Rc >30-38 Rc	230 195	0.00016 0.00016	0.00026 0.00026	0.00035 0.00035	0.00059 0.00059	•	•	•	•	•	•
Nitriding steels	≥24-30 Rc >30-38 Rc	230 195	0.00016 0.00016	0.00026 0.00026	0.00035 0.00035	0.00059 0.00059	•	•	•	•	•	•
Tool steels	≤24 Rc >24-30 Rc	230 195	0.00008 0.00008	0.00018 0.00018	0.00028 0.00028	0.00043 0.00043	•	•	•	•	•	•
High speed steels	≥14-30 Rc	165	0.00008	0.00018	0.00028	0.00043	•	•	•	•	•	•
Spring steels	≤330 Bhn	195	0.00016	0.00026	0.00035	0.00059	•	•	•	•	•	•
Stainless steels, sulphured austenitic martensitic	≤24 Rc ≤24 Rc ≤24 Rc	165 130 115	0.00016 0.00016 0.00016	0.00026 0.00026 0.00026	0.00035 0.00035 0.00035	0.00059 0.00059 0.00059	•	•	•	•	•	•
Hardened steels	≤40-48 Rc >48-60 Rc	80 65	0.00008 0.00008	0.00018 0.00018	0.00028 0.00028	0.00043 0.00043	•	•	•	•	•	•
Special alloys	≤38 Rc	100	0.00008	0.00018	0.00028	0.00043	•	•	•	•	•	•
Cast iron	≤240 Bhn <300 Bhn	260 245	0.00031 0.00031	0.00055 0.00055	0.00094 0.00094	0.00150 0.00150	•	•	•	•	•	•
Spheroidal graphite iron and malleable cast iron	≤240 Bhn <300 Bhn	245 215	0.00024 0.00024	0.00035 0.00035	0.00051 0.00051	0.00098 0.00098	•	•	•	•	•	•
Chilled cast iron	≤350 Bhn	165	0.00016	0.00026	0.00035	0.00059	•	•	•	•	•	•
Ti and Ti-alloys	≤24 Rc >24-38 Rc	100 80	0.00008 0.00008	0.00018 0.00018	0.00028 0.00028	0.00043 0.00043	•	•	•	•	•	•
Aluminium and Al-alloys	≤120 Bhn	460	0.00031	0.00055	0.00094	0.00150	•	•	•	•	•	•
Al wrought alloys	≤150 Bhn	375	0.00031	0.00055	0.00094	0.00150	•	•	•	•	•	•
Al cast alloys ≤ 10 % Si > 10 % Si	≤200 Bhn ≤200 Bhn	460 395	0.00079 0.00079	0.00157 0.00157	0.00240 0.00240	0.00276 0.00276	•	•	•	•	•	•
Magnesium alloys	≤150 Bhn	0	0.00047	0.00087	0.00138	0.00197	•	•	•	•	•	•
Copper, low-alloyed	≤120 Bhn	230	0.00024	0.00035	0.00051	0.00098	•	•	•	•	•	•
Brass, short-chipping long-chipping	≤200 Bhn ≤200 Bhn	375 280	0.00079 0.00079	0.00157 0.00157	0.00240 0.00240	0.00276 0.00276	•	•	•	•	•	•
Bronze, short-chipping	≤200 Bhn >200-260 Bhn	295 295	0.00047 0.00047	0.00087 0.00087	0.00138 0.00138	0.00197 0.00197	•	•	•	•	•	•
Bronze, long-chipping	≤24 Rc >24-30 Rc	215 215	0.00047 0.00024	0.00087 0.00035	0.00138 0.00051	0.00197 0.00098	•	•	•	•	•	•
Duroplastics	-	230	0.00024	0.00035	0.00051	0.00098	•	•	•	•	•	•
Thermoplastics	-	215	0.00024	0.00035	0.00051	0.00098	•	•	•	•	•	•
Reinforced plastics - Kevlar	-	180	0.00016	0.00026	0.00035	0.00059	•	•	•	•	•	•
Reinforced plastics - GFK / CFK	-	150	0.00016	0.00026	0.00035	0.00059	•	•	•	•	•	•

RPM = $\frac{SFM}{DIAM. \text{ in.}} \times 3.82$ $IPM = IPR \times RPM$

$\frac{HOLE \text{ DEPTH in.}}{IPM} \times 60 = \text{Cut Time}$

mm = in. x 25.40

m/min. = $SFM \div 3.28$
mm/rev. = $IPR \times 25.40$

Bar = $PSI \div 14.50$
Liter = $Gal. \div 3.79$

Series # 5510

Material group	Hardness	SFM	Feed Rate - IPR												
			1/16 in. 1.590 mm	1/8 in. 3.170 mm	1/4 in. 6.350 mm	3/8 in. 9.520 mm	1/2 in. 12.700 mm	5/8 in. 15.870 mm	3/4 in. 19.050 mm	1 in. 25.400 mm	1 1/4 in. 31.750 mm	1 1/2 in. 38.100 mm			
Common structural steels	≤100 Bhn >100-260 Bhn	475 395	•	•	•	•	•	•	•	•	•	•	•	•	•
Free-cutting steels	≤24 Rc >24-30 Rc	560 475	•	•	•	•	•	•	•	•	•	•	•	•	•
Unalloyed heat-treatable steels	≤16 Rc 16-24 Rc 24-30 Rc	425 410 395	•	•	•	•	•	•	•	•	•	•	•	•	•
Alloyed heat-treatable steels	24-30 Rc >30-38 Rc	395 345	•	•	•	•	•	•	•	•	•	•	•	•	•
Unalloyed case hardened steels	≤230 Bhn	475	•	•	•	•	•	•	•	•	•	•	•	•	•
Alloyed case hardened steels	24-30 Rc >30-38 Rc	395 280	•	•	•	•	•	•	•	•	•	•	•	•	•
Nitriding steels	≥24-30 Rc >30-38 Rc	360 345	•	•	•	•	•	•	•	•	•	•	•	•	•
Tool steels	≤24 Rc >24-30 Rc	260 215	•	•	•	•	•	•	•	•	•	•	•	•	•
High speed steels	≥14-30 Rc	195	•	•	•	•	•	•	•	•	•	•	•	•	•
Spring steels	≤330 Bhn	195	•	•	•	•	•	•	•	•	•	•	•	•	•
Stainless steels, sulphured austenitic martensitic	≤24 Rc ≤24 Rc ≤24 Rc	195 180 165	•	•	•	•	•	•	•	•	•	•	•	•	•
Hardened steels	≤40-48 Rc >48-60 Rc	180 115	•	•	•	•	•	•	•	•	•	•	•	•	•
Special alloys	≤38 Rc	115	•	•	•	•	•	•	•	•	•	•	•	•	•
Cast iron	≤240 Bhn <300 Bhn	690 525	•	•	•	•	•	•	•	•	•	•	•	•	•
Spheroidal graphite iron and malleable cast iron	≤240 Bhn <300 Bhn	460 425	•	•	•	•	•	•	•	•	•	•	•	•	•
Chilled cast iron	≤350 Bhn	130	•	•	•	•	•	•	•	•	•	•	•	•	•
Ti and Ti-alloys	≤24 Rc >24-38 Rc	150 130	•	•	•	•	•	•	•	•	•	•	•	•	•
Aluminium and Al-alloys	≤120 Bhn	1015	•	•	•	•	•	•	•	•	•	•	•	•	•
Al wrought alloys	≤150 Bhn	1015	•	•	•	•	•	•	•	•	•	•	•	•	•
Al cast alloys ≤ 10 % Si > 10 % Si	≤200 Bhn ≤200 Bhn	855 720	•	•	•	•	•	•	•	•	•	•	•	•	•
Magnesium alloys	≤150 Bhn	920	•	•	•	•	•	•	•	•	•	•	•	•	•
Copper, low-alloyed	≤120 Bhn	410	•	•	•	•	•	•	•	•	•	•	•	•	•
Brass, short-chipping long-chipping	≤200 Bhn ≤200 Bhn	1065 720	•	•	•	•	•	•	•	•	•	•	•	•	•
Bronze, short-chipping	≤200 Bhn >200-260 Bhn	410 345	•	•	•	•	•	•	•	•	•	•	•	•	•
Bronze, long-chipping	≤24 Rc >24-30 Rc	295 260	•	•	•	•	•	•	•	•	•	•	•	•	•
Duroplastics	-	•	•	•	•	•	•	•	•	•	•	•	•	•	•
Thermoplastics	-	•	•	•	•	•	•	•	•	•	•	•	•	•	•
Reinforced plastics - Kevlar	-	•	•	•	•	•	•	•	•	•	•	•	•	•	•
Reinforced plastics - GFK / CFK	-	•	•	•	•	•	•	•	•	•	•	•	•	•	•

Series # 5511

Material group	Hardness	SFM	Feed Rate - IPR												
			1/16 in. 1.590 mm	1/8 in. 3.170 mm	1/4 in. 6.350 mm	3/8 in. 9.520 mm	1/2 in. 12.700 mm	5/8 in. 15.870 mm	3/4 in. 19.050 mm	1 in. 25.400 mm	1 1/4 in. 31.750 mm	1 1/2 in. 38.100 mm			
Common structural steels	≤100 Bhn >100-260 Bhn	475 395	•	•	•	•	•	•	•	•	•	•	•	•	•
Free-cutting steels	≤24 Rc >24-30 Rc	560 475	•	•	•	•	•	•	•	•	•	•	•	•	•
Unalloyed heat-treatable steels	≤16 Rc 16-24 Rc 24-30 Rc	425 410 395	•	•	•	•	•	•	•	•	•	•	•	•	•
Alloyed heat-treatable steels	24-30 Rc >30-38 Rc	395 345	•	•	•	•	•	•	•	•	•	•	•	•	•
Unalloyed case hardened steels	≤230 Bhn	475	•	•	•	•	•	•	•	•	•	•	•	•	•
Alloyed case hardened steels	24-30 Rc >30-38 Rc	395 280	•	•	•	•	•	•	•	•	•	•	•	•	•
Nitriding steels	≥24-30 Rc >30-38 Rc	350 330	•	•	•	•	•	•	•	•	•	•	•	•	•
Tool steels	≤24 Rc >24-30 Rc	240 180	•	•	•	•	•	•	•	•	•	•	•	•	•
High speed steels	≥14-30 Rc	195	•	•	•	•	•	•	•	•	•	•	•	•	•
Spring steels	≤330 Bhn	195	•	•	•	•	•	•	•	•	•	•	•	•	•
Stainless steels, sulphured austenitic martensitic	≤24 Rc ≤24 Rc ≤24 Rc	195 180 165	•	•	•	•	•	•	•	•	•	•	•	•	•
Hardened steels	≤40-48 Rc >48-60 Rc	180 115	•	•	•	•	•	•	•	•	•	•	•	•	•
Special alloys	≤38 Rc	115	•	•	•	•	•	•	•	•	•	•	•	•	•
Cast iron	≤240 Bhn <300 Bhn	690 525	•	•	•	•	•	•	•	•	•	•	•	•	•
Spheroidal graphite iron and malleable cast iron	≤240 Bhn <300 Bhn	450 425	•	•	•	•	•	•	•	•	•	•	•	•	•
Chilled cast iron	≤350 Bhn	130	•	•	•	•	•	•	•	•	•	•	•	•	•
Ti and Ti-alloys	≤24 Rc >24-38 Rc	150 130	•	•	•	•	•	•	•	•	•	•	•	•	•
Aluminium and Al-alloys	≤120 Bhn	1015	•	•	•	•	•	•	•	•	•	•	•	•	•
Al wrought alloys	≤150 Bhn	1015	•	•	•	•	•	•	•	•	•	•	•	•	•
Al cast alloys ≤ 10 % Si > 10 % Si	≤200 Bhn ≤200 Bhn	855 720	•	•	•	•	•	•	•	•	•	•	•	•	•
Magnesium alloys	≤150 Bhn	920	•	•	•	•	•	•	•	•	•	•	•	•	•
Copper, low-alloyed	≤120 Bhn	410	•	•	•	•	•	•	•	•	•	•	•	•	•
Brass, short-chipping long-chipping	≤200 Bhn ≤200 Bhn	1065 720	•	•	•	•	•	•	•	•	•	•	•	•	•
Bronze, short-chipping	≤200 Bhn >200-260 Bhn	410 345	•	•	•	•	•	•	•	•	•	•	•	•	•
Bronze, long-chipping	≤24 Rc >24-30 Rc	295 260	•	•	•	•	•	•	•	•	•	•	•	•	•
Duroplastics	-	•	•	•	•	•	•	•	•	•	•	•	•	•	•
Thermoplastics	-	•	•	•	•	•	•	•	•	•	•	•	•	•	•
Reinforced plastics - Kevlar	-	•	•	•	•	•	•	•	•	•	•	•	•	•	•
Reinforced plastics - GFK / CFK	-	•	•	•	•	•	•	•	•	•	•	•	•	•	•

Using These Tables. The Speeds & Feeds listed below are conservative recommendations for initial setup. In actual use, depending on the machining environment and workpiece material, significantly higher speeds and feeds may be achievable. Using the below as a starting point, cutting speed/feed can be gradually adjusted upwards until the optimum settings per application are found.
Questions? Contact us by telephone at (800) 776-6170.

Series # 5512

Material group	Hardness	SFM	Feed Rate - IPR											
			1/16 in. 1.590 mm	1/8 in. 3.170 mm	1/4 in. 6.350 mm	3/8 in. 9.520 mm	1/2 in. 12.700 mm	5/8 in. 15.870 mm	3/4 in. 19.050 mm	1 in. 25.400 mm	1 1/4 in. 31.750 mm	1 1/2 in. 38.100 mm		
Common structural steels	≤100 Bhn >100-260 Bhn	460 395	•	•	•	•	•	•	•	•	•	•	•	•
Free-cutting steels	≤24 Rc >24-30 Rc	550 480	•	•	•	•	•	•	•	•	•	•	•	•
Unalloyed heat-treatable steels	≤16 Rc 16-24 Rc 24-30 Rc	415 400 395	•	•	•	•	•	•	•	•	•	•	•	•
Alloyed heat-treatable steels	24-30 Rc >30-38 Rc	395 335	•	•	•	•	•	•	•	•	•	•	•	•
Unalloyed case hardened steels	≤230 Bhn	465	•	•	•	•	•	•	•	•	•	•	•	•
Alloyed case hardened steels	24-30 Rc >30-38 Rc	395 270	•	•	•	•	•	•	•	•	•	•	•	•
Nitriding steels	≥24-30 Rc >30-38 Rc	340 325	•	•	•	•	•	•	•	•	•	•	•	•
Tool steels	≤24 Rc >24-30 Rc	230 175	•	•	•	•	•	•	•	•	•	•	•	•
High speed steels	≥14-30 Rc	195	•	•	•	•	•	•	•	•	•	•	•	•
Spring steels	≤330 Bhn	195	•	•	•	•	•	•	•	•	•	•	•	•
Stainless steels, sulphured austenitic martensitic	≤24 Rc ≤24 Rc ≤24 Rc	195 175 155	•	•	•	•	•	•	•	•	•	•	•	•
Hardened steels	≤40-48 Rc >48-60 Rc	175 110	•	•	•	•	•	•	•	•	•	•	•	•
Special alloys	≤38 Rc	110	•	•	•	•	•	•	•	•	•	•	•	•
Cast iron	≤240 Bhn <300 Bhn	640 525	•	•	•	•	•	•	•	•	•	•	•	•
Spheroidal graphite iron and malleable cast iron	≤240 Bhn <300 Bhn	435 415	•	•	•	•	•	•	•	•	•	•	•	•
Chilled cast iron	≤350 Bhn	130	•	•	•	•	•	•	•	•	•	•	•	•
Ti and Ti-alloys	≤24 Rc >24-38 Rc	140 130	•	•	•	•	•	•	•	•	•	•	•	•
Aluminium and Al-alloys	≤120 Bhn	1000	•	•	•	•	•	•	•	•	•	•	•	•
Al wrought alloys	≤150 Bhn	1000	•	•	•	•	•	•	•	•	•	•	•	•
Al cast alloys ≤ 10 % Si > 10 % Si	≤200 Bhn ≤200 Bhn	845 710	•	•	•	•	•	•	•	•	•	•	•	•
Magnesium alloys	≤150 Bhn	900	•	•	•	•	•	•	•	•	•	•	•	•
Copper, low-alloyed	≤120 Bhn	400	•	•	•	•	•	•	•	•	•	•	•	•
Brass, short-chipping long-chipping	≤200 Bhn ≤200 Bhn	1050 710	•	•	•	•	•	•	•	•	•	•	•	•
Bronze, short-chipping	≤200 Bhn >200-260 Bhn	410 345	•	•	•	•	•	•	•	•	•	•	•	•
Bronze, long-chipping	≤24 Rc >24-30 Rc	285 250	•	•	•	•	•	•	•	•	•	•	•	•
Duroplastics	-	-	•	•	•	•	•	•	•	•	•	•	•	•
Thermoplastics	-	-	•	•	•	•	•	•	•	•	•	•	•	•
Reinforced plastics - Kevlar	-	-	•	•	•	•	•	•	•	•	•	•	•	•
Reinforced plastics - GFK / CFK	-	-	•	•	•	•	•	•	•	•	•	•	•	•

Series # 5513

Material group	Hardness	SFM	Feed Rate - IPR											
			1/16 in. 1.590 mm	1/8 in. 3.170 mm	1/4 in. 6.350 mm	3/8 in. 9.520 mm	1/2 in. 12.700 mm	5/8 in. 15.870 mm	3/4 in. 19.050 mm	1 in. 25.400 mm	1 1/4 in. 31.750 mm	1 1/2 in. 38.100 mm		
Common structural steels	≤100 Bhn >100-260 Bhn	•	•	•	•	•	•	•	•	•	•	•	•	•
Free-cutting steels	≤24 Rc >24-30 Rc	•	•	•	•	•	•	•	•	•	•	•	•	•
Unalloyed heat-treatable steels	≤16 Rc 16-24 Rc 24-30 Rc	•	•	•	•	•	•	•	•	•	•	•	•	•
Alloyed heat-treatable steels	24-30 Rc >30-38 Rc	•	•	•	•	•	•	•	•	•	•	•	•	•
Unalloyed case hardened steels	≤230 Bhn	•	•	•	•	•	•	•	•	•	•	•	•	•
Alloyed case hardened steels	24-30 Rc >30-38 Rc	•	•	•	•	•	•	•	•	•	•	•	•	•
Nitriding steels	≥24-30 Rc >30-38 Rc	•	•	•	•	•	•	•	•	•	•	•	•	•
Tool steels	≤24 Rc >24-30 Rc	•	•	•	•	•	•	•	•	•	•	•	•	•
High speed steels	≥14-30 Rc	•	•	•	•	•	•	•	•	•	•	•	•	•
Spring steels	≤330 Bhn	•	•	•	•	•	•	•	•	•	•	•	•	•
Stainless steels, sulphured austenitic martensitic	≤24 Rc ≤24 Rc ≤24 Rc	•	•	•	•	•	•	•	•	•	•	•	•	•
Hardened steels	≤40-48 Rc >48-60 Rc	•	•	•	•	•	•	•	•	•	•	•	•	•
Special alloys	≤38 Rc	•	•	•	•	•	•	•	•	•	•	•	•	•
Cast iron	≤240 Bhn <300 Bhn	395 330	•	•	•	•	•	•	•	•	•	•	•	•
Spheroidal graphite iron and malleable cast iron	≤240 Bhn <300 Bhn	295 260	•	•	•	•	•	•	•	•	•	•	•	•
Chilled cast iron	≤350 Bhn	130	•	•	•	•	•	•	•	•	•	•	•	•
Ti and Ti-alloys	≤24 Rc >24-38 Rc	•	•	•	•	•	•	•	•	•	•	•	•	•
Aluminium and Al-alloys	≤120 Bhn	1345	•	•	•	•	•	•	•	•	•	•	•	•
Al wrought alloys	≤150 Bhn	1345	•	•	•	•	•	•	•	•	•	•	•	•
Al cast alloys ≤ 10 % Si > 10 % Si	≤200 Bhn ≤200 Bhn	1245 1080	•	•	•	•	•	•	•	•	•	•	•	•
Magnesium alloys	≤150 Bhn	•	•	•	•	•	•	•	•	•	•	•	•	•
Copper, low-alloyed	≤120 Bhn	•	•	•	•	•	•	•	•	•	•	•	•	•
Brass, short-chipping long-chipping	≤200 Bhn ≤200 Bhn	920	•	•	•	•	•	•	•	•	•	•	•	•
Bronze, short-chipping	≤200 Bhn >200-260 Bhn	360 260	•	•	•	•	•	•	•	•	•	•	•	•
Bronze, long-chipping	≤24 Rc >24-30 Rc	•	•	•	•	•	•	•	•	•	•	•	•	•
Duroplastics	-	•	•	•	•	•	•	•	•	•	•	•	•	•
Thermoplastics	-	•	•	•	•	•	•	•	•	•	•	•	•	•
Reinforced plastics - Kevlar	-	•	•	•	•	•	•	•	•	•	•	•	•	•
Reinforced plastics - GFK / CFK	-	•	•	•	•	•	•	•	•	•	•	•	•	•

Note: Pilot holes (depth ≥1xD) are recommended when drilling depths greater than 7xD. The pilot hole can be produced with a short, rigid drill. The diameter should be 0.01 - 0.02 mm larger than the diameter of the finish drill. Ratio drills can produce their own pilot hole by reducing speed and feed rates by 30-40%.

$$\text{RPM} = \frac{\text{SFM}}{\text{DIAM. in.}} \times 3.82 \quad \text{IPM} = \text{IPR} \times \text{RPM}$$

$$\text{HOLE DEPTH in.} \div \text{IPM} \times 60 = \text{Cut Time} \quad \text{mm} = \text{in.} \times 25.40$$

$$\text{m/min.} = \text{SFM} \div 3.28 \quad \text{Bar} = \text{PSI} \div 14.50$$

$$\text{mm/rev.} = \text{IPR} \div 25.40 \quad \text{Liter} = \text{Gal.} \div 3.79$$

Series # 5514

Material group	Hardness	SFM	Feed Rate - IPR										
			1/16 in. 1.590 mm	1/8 in. 3.170 mm	1/4 in. 6.350 mm	3/8 in. 9.520 mm	1/2 in. 12.700 mm	5/8 in. 15.870 mm	3/4 in. 19.050 mm	1 in. 25.400 mm	1 1/4 in. 31.750 mm	1 1/2 in. 38.100 mm	
Common structural steels	≤100 Bhn >100-260 Bhn	425 360	•	0.0065	0.0100	0.0125	0.0160	0.0160	0.0160	•	•	•	•
Free-cutting steels	≤24 Rc >24-30 Rc	475 360	•	0.0080	0.0125	0.0160	0.0200	0.0200	0.0200	•	•	•	•
Unalloyed heat-treatable steels	≤16 Rc 16-24 Rc 24-30 Rc	395 360 345	•	0.0065	0.0100	0.0125	0.0160	0.0160	0.0160	•	•	•	•
Alloyed heat-treatable steels	24-30 Rc >30-38 Rc	345 330	•	0.0065	0.0100	0.0125	0.0160	0.0160	0.0160	•	•	•	•
Unalloyed case hardened steels	≤230 Bhn	425	•	0.0080	0.0125	0.0160	0.0200	0.0200	0.0200	•	•	•	•
Alloyed case hardened steels	24-30 Rc >30-38 Rc	395 280	•	0.0065	0.0100	0.0125	0.0160	0.0160	0.0160	•	•	•	•
Nitriding steels	≥24-30 Rc >30-38 Rc	330 295	•	0.0050	0.0080	0.0100	0.0125	0.0125	0.0125	•	•	•	•
Tool steels	≤24 Rc >24-30 Rc	215 180	•	0.0050	0.0080	0.0100	0.0125	0.0125	0.0125	•	•	•	•
High speed steels	≥14-30 Rc	150	•	0.0030	0.0050	0.0065	0.0080	0.0080	0.0080	•	•	•	•
Spring steels	≤330 Bhn	150	•	0.0025	0.0040	0.0050	0.0065	0.0065	0.0065	•	•	•	•
Stainless steels, sulphured austenitic martensitic	≤24 Rc 150 150	180 150 150	•	0.0030 0.0030 0.0025	0.0050 0.0050 0.0040	0.0065 0.0065 0.0050	0.0080 0.0080 0.0065	0.0080 0.0080 0.0065	0.0080 0.0080 0.0065	•	•	•	•
Hardened steels	≤40-48 Rc >48-60 Rc	150 80	•	0.0025 0.0020	0.0040 0.0030	0.0050 0.0040	0.0065 0.0050	0.0065 0.0050	0.0065 0.0050	•	•	•	•
Special alloys	≤38 Rc	80	•	0.0030	0.0050	0.0065	0.0080	0.0080	0.0080	•	•	•	•
Cast iron	≤240 Bhn <300 Bhn	690 510	•	0.0080 0.0080	0.0125 0.0125	0.0160 0.0160	0.0200 0.0200	0.0200 0.0200	0.0200 0.0200	•	•	•	•
Spheroidal graphite iron and malleable cast iron	≤240 Bhn <300 Bhn	510 410	•	0.0065 0.0065	0.0100 0.0100	0.0125 0.0125	0.0160 0.0160	0.0160 0.0160	0.0160 0.0160	•	•	•	•
Chilled cast iron	≤350 Bhn	115	•	0.0025	0.0040	0.0050	0.0065	0.0065	0.0065	•	•	•	•
Ti and Ti-alloys	≤24 Rc >24-38 Rc	130 115	•	0.0030 0.0025	0.0050 0.0040	0.0065 0.0050	0.0080 0.0065	0.0080 0.0065	0.0080 0.0065	•	•	•	•
Aluminium and Al-alloys	≤120 Bhn	855	•	0.0100	0.0160	0.0200	0.0245	0.0245	0.0245	•	•	•	•
Al wrought alloys	≤150 Bhn	855	•	0.0100	0.0160	0.0200	0.0245	0.0245	0.0245	•	•	•	•
Al cast alloys ≤ 10 % Si > 10 % Si	≤200 Bhn 590	720 590	•	0.0080 0.0080	0.0125 0.0125	0.0160 0.0160	0.0200 0.0200	0.0200 0.0200	0.0200 0.0200	•	•	•	•
Magnesium alloys	≤150 Bhn	855	•	0.0080	0.0125	0.0160	0.0200	0.0200	0.0200	•	•	•	•
Copper, low-alloyed	≤120 Bhn	360	•	0.0065	0.0065	0.0100	0.0125	0.0125	0.0125	•	•	•	•
Brass, short-chipping long-chipping	≤200 Bhn 590	885 590	•	0.0080 0.0065	0.0125 0.0100	0.0160 0.0125	0.0200 0.0160	0.0200 0.0160	0.0200 0.0160	•	•	•	•
Bronze, short-chipping	≤200 Bhn >200-260 Bhn	360 330	•	0.0065 0.0050	0.0065 0.0050	0.0080 0.0080	0.0100 0.0100	0.0125 0.0100	0.0125 0.0100	•	•	•	•
Bronze, long-chipping	≤24 Rc >24-30 Rc	240 215	•	0.0050 0.0050	0.0050 0.0050	0.0080 0.0080	0.0100 0.0100	0.0100 0.0100	0.0100 0.0100	•	•	•	•
Duroplastics	-	•	•	•	•	•	•	•	•	•	•	•	•
Thermoplastics	-	•	•	•	•	•	•	•	•	•	•	•	•
Reinforced plastics - Kevlar	-	•	•	•	•	•	•	•	•	•	•	•	•
Reinforced plastics - GFK / CFK	-	•	•	•	•	•	•	•	•	•	•	•	•

Series # 5515

Material group	Hardness	SFM	Feed Rate - IPR										
			1/16 in. 1.590 mm	1/8 in. 3.170 mm	1/4 in. 6.350 mm	3/8 in. 9.520 mm	1/2 in. 12.700 mm	5/8 in. 15.870 mm	3/4 in. 19.050 mm	1 in. 25.400 mm	1 1/4 in. 31.750 mm	1 1/2 in. 38.100 mm	
Common structural steels	≤100 Bhn >100-260 Bhn	425 360	•	0.0065	0.0100	0.0125	0.0160	0.0160	0.0160	•	•	•	•
Free-cutting steels	≤24 Rc >24-30 Rc	475 360	•	0.0080	0.0125	0.0160	0.0200	0.0200	0.0200	•	•	•	•
Unalloyed heat-treatable steels	≤16 Rc 16-24 Rc 24-30 Rc	395 360 345	•	0.0065	0.0100	0.0125	0.0160	0.0160	0.0160	•	•	•	•
Alloyed heat-treatable steels	24-30 Rc >30-38 Rc	345 330	•	0.0065	0.0100	0.0125	0.0160	0.0160	0.0160	•	•	•	•
Unalloyed case hardened steels	≤230 Bhn	425	•	0.0080	0.0125	0.0160	0.0200	0.0200	0.0200	•	•	•	•
Alloyed case hardened steels	24-30 Rc >30-38 Rc	395 280	•	0.0065	0.0100	0.0125	0.0160	0.0160	0.0160	•	•	•	•
Nitriding steels	≥24-30 Rc >30-38 Rc	320 280	•	0.0050	0.0080	0.0100	0.0125	0.0125	0.0125	•	•	•	•
Tool steels	≤24 Rc >24-30 Rc	195 145	•	0.0050	0.0080	0.0100	0.0125	0.0125	0.0125	•	•	•	•
High speed steels	≥14-30 Rc	150	•	0.0030	0.0050	0.0065	0.0080	0.0080	0.0080	•	•	•	•
Spring steels	≤330 Bhn	150	•	0.0025	0.0040	0.0050	0.0065	0.0065	0.0065	•	•	•	•
Stainless steels, sulphured austenitic martensitic	≤24 Rc 180 150 150	180 150 150	•	0.0030 0.0030 0.0025	0.0050 0.0050 0.0040	0.0065 0.0065 0.0050	0.0080 0.0080 0.0065	0.0080 0.0080 0.0065	0.0080 0.0080 0.0065	•	•	•	•
Hardened steels	≤40-48 Rc >48-60 Rc	150 80	•	0.0025 0.0020	0.0040 0.0030	0.0050 0.0040	0.0065 0.0050	0.0065 0.0050	0.0065 0.0050	•	•	•	•
Special alloys	≤38 Rc	80	•	0.0030	0.0050	0.0065	0.0080	0.0080	0.0080	•	•	•	•
Cast iron	≤240 Bhn <300 Bhn	690 510	•	0.0080 0.0080	0.0125 0.0125	0.0160 0.0160	0.0200 0.0200	0.0200 0.0200	0.0200 0.0200	•	•	•	•
Spheroidal graphite iron and malleable cast iron	≤240 Bhn <300 Bhn	475 410	•	0.0065 0.0065	0.0100 0.0100	0.0125 0.0125	0.0160 0.0160	0.0160 0.0160	0.0160 0.0160	•	•	•	•
Chilled cast iron	≤350 Bhn	115	•	0.0025	0.0040	0.0050	0.0065	0.0065	0.0065	•	•	•	•
Ti and Ti-alloys	≤24 Rc >24-38 Rc	130 115	•	0.0030 0.0025	0.0050 0.0040	0.0065 0.0050	0.0080 0.0065	0.0080 0.0065	0.0080 0.0065	•	•	•	•
Aluminium and Al-alloys	≤120 Bhn	855	•	0.0080	0.0125	0.0160	0.0200	0.0200	0.0200	•	•	•	•
Al wrought alloys	≤150 Bhn	855	•	0.0080	0.0125	0.0160	0.0200	0.0200	0.0200	•	•	•	•
Al cast alloys ≤ 10 % Si > 10 % Si	≤200 Bhn 560	700 560	•	0.0080 0.0080	0.0125 0.0125	0.0160 0.0160	0.0200 0.0200	0.0200 0.0200	0.0200 0.0200	•	•	•	•
Magnesium alloys	≤150 Bhn	855	•	0.0080	0.0125	0.0160	0.0200	0.0200	0.0200	•	•	•	•
Copper, low-alloyed	≤120 Bhn	360	•	0.0065	0.0100	0.0100	0.0125	0.0125	0.0160	•	•	•	•
Brass, short-chipping long-chipping	≤200 Bhn 590	885 590	•	0.0080 0.0065	0.0125 0.0100	0.0160 0.0125	0.0200 0.0160	0.0200 0.0160	0.0200 0.0160	•	•	•	•
Bronze, short-chipping	≤200 Bhn >200-260 Bhn	360 330	•	0.0065 0.0050	0.0100 0.0080	0.0100 0.0080	0.0125 0.0100	0.0160 0.0125	0.0160 0.0125	•	•	•	•
Bronze, long-chipping	≤24 Rc >24-30 Rc	240 215	•	0.0050 0.0050	0.0080 0.0080	0.0080 0.0080	0.0100 0.0100	0.0125 0.0125	0.0125 0.0125	•	•	•	•
Duroplastics	-	•	•	•	•	•	•	•	•	•	•	•	•
Thermoplastics	-	•	•	•	•	•	•	•	•	•	•	•	•
Reinforced plastics - Kevlar	-	•	•	•	•	•	•	•	•	•	•	•	•
Reinforced plastics - GFK / CFK	-	•	•	•	•	•	•	•	•	•	•	•	•

Using These Tables. The Speeds & Feeds listed below are conservative recommendations for initial setup. In actual use, depending on the machining environment and workpiece material, significantly higher speeds and feeds may be achievable. Using the below as a starting point, cutting speed/feed can be gradually adjusted upwards until the optimum settings per application are found. Questions? Contact us by telephone at (800) 776-6170.

Series # 5518

Material group	Hardness	SFM	Feed Rate - IPR										
			1/16 in. 1.590 mm	1/8 in. 3.170 mm	1/4 in. 6.350 mm	3/8 in. 9.520 mm	1/2 in. 12.700 mm	5/8 in. 15.870 mm	3/4 in. 19.050 mm	1 in. 25.400 mm	1 1/4 in. 31.750 mm	1 1/2 in. 38.100 mm	
Common structural steels	≤100 Bhn	260	•	0.0035	0.005	0.008	0.008	0.008	0.01	0.0125	0.016	•	•
	>100-260 Bhn	210	•	0.0025	0.004	0.0065	0.0065	0.0065	0.008	0.01	0.0125	•	•
Free-cutting steels	≤24 Rc	295	•	0.004	0.0065	0.01	0.01	0.0125	0.016	0.02	•	•	•
	>24-30 Rc	245	•	0.0035	0.005	0.008	0.008	0.01	0.0125	0.016	•	•	•
Unalloyed heat-treatable steels	≤16 Rc	225	•	0.0035	0.005	0.008	0.008	0.01	0.0125	0.016	•	•	•
	16-24 Rc	210	•	0.0035	0.005	0.008	0.008	0.01	0.0125	0.016	•	•	•
	24-30 Rc	195	•	0.0035	0.005	0.008	0.008	0.01	0.0125	0.016	•	•	•
Alloyed heat-treatable steels	24-30 Rc	195	•	0.0035	0.005	0.008	0.008	0.01	0.0125	0.016	•	•	•
	>30-38 Rc	160	•	0.0025	0.004	0.0065	0.0065	0.008	0.01	0.0125	•	•	•
Unalloyed case hardened steels	≤230 Bhn	260	•	0.004	0.0065	0.01	0.01	0.0125	0.016	0.02	•	•	•
Alloyed case hardened steels	24-30 Rc	195	•	0.0035	0.005	0.008	0.008	0.01	0.0125	0.016	•	•	•
	>30-38 Rc	160	•	0.0025	0.004	0.0065	0.0065	0.008	0.01	0.0125	•	•	•
Nitriding steels	≥24-30 Rc	180	•	0.0025	0.004	0.0065	0.0065	0.008	0.01	0.0125	•	•	•
	>30-38 Rc	160	•	0.0025	0.004	0.0065	0.0065	0.008	0.01	0.0125	•	•	•
Tool steels	≤24 Rc	145	•	0.0025	0.004	0.0065	0.0065	0.008	0.01	0.0125	•	•	•
	>24-30 Rc	110	•	0.0025	0.004	0.0065	0.0065	0.008	0.01	0.0125	•	•	•
High speed steels	≥14-30 Rc	95	•	0.002	0.0035	0.005	0.005	0.0065	0.008	0.01	•	•	•
Spring steels	≤330 Bhn	•	•	•	•	•	•	•	•	•	•	•	•
Stainless steels, sulphured austenitic martensitic	≤24 Rc	•	•	•	•	•	•	•	•	•	•	•	•
	≤24 Rc	•	•	•	•	•	•	•	•	•	•	•	•
	≤24 Rc	•	•	•	•	•	•	•	•	•	•	•	•
Hardened steels	≤40-48 Rc	•	•	•	•	•	•	•	•	•	•	•	•
	>48-60 Rc	•	•	•	•	•	•	•	•	•	•	•	•
Special alloys	≤38 Rc	•	•	•	•	•	•	•	•	•	•	•	•
Cast iron	≤240 Bhn	325	•	0.004	0.0065	0.01	0.01	0.0125	0.016	0.02	•	•	•
	<300 Bhn	260	•	0.004	0.0065	0.01	0.01	0.0125	0.016	0.02	•	•	•
Spheroidal graphite iron and malleable cast iron	≤240 Bhn	260	•	0.004	0.0065	0.01	0.01	0.0125	0.016	0.02	•	•	•
	<300 Bhn	225	•	0.004	0.0065	0.01	0.01	0.0125	0.016	0.02	•	•	•
Chilled cast iron	≤350 Bhn	•	•	•	•	•	•	•	•	•	•	•	•
Ti and Ti-alloys	≤24 Rc	•	•	•	•	•	•	•	•	•	•	•	•
	>24-38 Rc	•	•	•	•	•	•	•	•	•	•	•	•
Aluminium and Al-alloys	≤120 Bhn	590	•	0.005	0.008	0.0125	0.0125	0.016	0.02	0.025	•	•	•
	Al wrought alloys	≤150 Bhn	520	•	0.005	0.008	0.0125	0.0125	0.016	0.02	0.025	•	•
Al cast alloys ≤ 10 % Si > 10 % Si	≤200 Bhn	490	•	0.005	0.008	0.0125	0.0125	0.016	0.02	0.025	•	•	•
	≤200 Bhn	390	•	0.004	0.0065	0.01	0.01	0.0125	0.016	0.02	•	•	•
Magnesium alloys	≤150 Bhn	590	•	0.004	0.0065	0.01	0.01	0.0125	0.016	0.02	•	•	•
Copper, low-alloyed	≤120 Bhn	•	•	•	•	•	•	•	•	•	•	•	•
Brass, short-chipping long-chipping	≤200 Bhn	590	•	0.004	0.0065	0.01	0.01	0.0125	0.016	0.02	•	•	•
	≤200 Bhn	•	•	•	•	•	•	•	•	•	•	•	•
Bronze, short-chipping	≤200 Bhn	•	•	•	•	•	•	•	•	•	•	•	•
	>200-260 Bhn	•	•	•	•	•	•	•	•	•	•	•	•
Bronze, long-chipping	≤24 Rc	•	•	•	•	•	•	•	•	•	•	•	•
	>24-30 Rc	•	•	•	•	•	•	•	•	•	•	•	•
Duroplastics	-	•	•	•	•	•	•	•	•	•	•	•	•
Thermoplastics	-	•	•	•	•	•	•	•	•	•	•	•	•
Reinforced plastics - Kevlar	-	•	•	•	•	•	•	•	•	•	•	•	•
Reinforced plastics - GFK / CFK	-	•	•	•	•	•	•	•	•	•	•	•	•

Series # 5519

Material group	Hardness	SFM	Feed Rate - IPR										
			1/16 in. 1.590 mm	1/8 in. 3.170 mm	1/4 in. 6.350 mm	3/8 in. 9.520 mm	1/2 in. 12.700 mm	5/8 in. 15.870 mm	3/4 in. 19.050 mm	1 in. 25.400 mm	1 1/4 in. 31.750 mm	1 1/2 in. 38.100 mm	
Common structural steels	≤100 Bhn	160	0.0017	0.0050	0.0080	0.0100	0.0125	0.0125	•	•	•	•	•
	>100-260 Bhn	130	0.0015	0.0040	0.0065	0.0080	0.0100	0.0100	•	•	•	•	•
Free-cutting steels	≤24 Rc	195	0.0017	0.0050	0.0080	0.0100	0.0125	0.0125	•	•	•	•	•
	>24-30 Rc	160	0.0017	0.0050	0.0080	0.0100	0.0125	0.0125	•	•	•	•	•
Unalloyed heat-treatable steels	≤16 Rc	160	0.0017	0.0050	0.0080	0.0100	0.0125	0.0125	•	•	•	•	•
	16-24 Rc	130	0.0017	0.0050	0.0080	0.0100	0.0125	0.0125	•	•	•	•	•
	24-30 Rc	80	0.0015	0.0040	0.0065	0.0080	0.0100	0.0100	•	•	•	•	•
Alloyed heat-treatable steels	24-30 Rc	70	0.0012	0.0030	0.0050	0.0065	0.0080	0.0080	•	•	•	•	•
	>30-38 Rc	45	0.0010	0.0025	0.0040	0.0050	0.0065	0.0065	•	•	•	•	•
Unalloyed case hardened steels	≤230 Bhn	130	0.0017	0.0050	0.0080	0.0100	0.0125	0.0125	•	•	•	•	•
Alloyed case hardened steels	24-30 Rc	65	0.0012	0.0030	0.0050	0.0065	0.0080	0.0080	•	•	•	•	•
	>30-38 Rc	45	0.0010	0.0025	0.0040	0.0050	0.0065	0.0065	•	•	•	•	•
Nitriding steels	≥24-30 Rc	55	0.0012	0.0030	0.0050	0.0065	0.0080	0.0080	•	•	•	•	•
	>30-38 Rc	45	0.0010	0.0025	0.0040	0.0050	0.0065	0.0065	•	•	•	•	•
Tool steels	≤24 Rc	70	0.0012	0.0030	0.0050	0.0065	0.0080	0.0080	•	•	•	•	•
	>24-30 Rc	40	0.0010	0.0025	0.0040	0.0050	0.0065	0.0065	•	•	•	•	•
High speed steels	≥14-30 Rc	40	0.0010	0.0025	0.0040	0.0050	0.0065	0.0065	•	•	•	•	•
Spring steels	≤330 Bhn	•	•	•	•	•	•	•	•	•	•	•	•
Stainless steels, sulphured austenitic martensitic	≤24 Rc	65	0.0012	0.0030	0.0050	0.0065	0.0080	0.0080	•	•	•	•	•
	≤24 Rc	45	0.0012	0.0030	0.0050	0.0065	0.0080	0.0080	•	•	•	•	•
	≤24 Rc	55	0.0012	0.0030	0.0050	0.0065	0.0080	0.0080	•	•	•	•	•
Hardened steels	≤40-48 Rc	•	•	•	•	•	•	•	•	•	•	•	•
	>48-60 Rc	•	•	•	•	•	•	•	•	•	•	•	•
Special alloys	≤38 Rc	•	•	•	•	•	•	•	•	•	•	•	•
Cast iron	≤240 Bhn	145	0.0017	0.0050	0.0080	0.0100	0.0125	0.0125	•	•	•	•	•
	<300 Bhn	115	0.0017	0.0050	0.0080	0.0100	0.0125	0.0125	•	•	•	•	•
Spheroidal graphite iron and malleable cast iron	≤240 Bhn	130	0.0017	0.0050	0.0080	0.0100	0.0125	0.0125	•	•	•	•	•
	<300 Bhn	100	0.0017	0.0050	0.0080	0.0100	0.0125	0.0125	•	•	•	•	•
Chilled cast iron	≤350 Bhn	•	•	•	•	•	•	•	•	•	•	•	•
Ti and Ti-alloys	≤24 Rc	•	•	•	•	•	•	•	•	•	•	•	•
	>24-38 Rc	•	•	•	•	•	•	•	•	•	•	•	•
Aluminium and Al-alloys	≤120 Bhn	225	0.0020	0.0065	0.0100	0.0125	0.0160	0.0160	•	•	•	•	•
	Al wrought alloys	≤150 Bhn	225	0.0020	0.0065	0.0100	0.0125	0.0160	0.0160	•	•	•	•
Al cast alloys ≤ 10 % Si > 10 % Si	≤200 Bhn	295	0.0020	0.0065	0.0100	0.0125	0.0160	0.0160	•	•	•	•	•
	≤200 Bhn	260	0.0017	0.0050	0.0080	0.0100	0.0125	0.0125	•	•	•	•	•
Magnesium alloys	≤150 Bhn	260	0.0017	0.0050	0.0080	0.0100	0.0125	0.0125	•	•	•	•	•
Copper, low-alloyed	≤120 Bhn	100	0.0015	0.0040	0.0065	0.0080	0.0100	0.0100	•	•	•	•	•
Brass, short-chipping long-chipping	≤200 Bhn	205	0.0015	0.0040	0.0065	0.0080	0.0100	0.0100	•	•	•	•	•
	≤200 Bhn	130	0.0015	0.0040	0.0065	0.0080	0.0100	0.0100	•	•	•	•	•
Bronze, short-chipping	≤200 Bhn	160	0.0012	0.0030	0.0050	0.0065	0.0080	0.008					

RPM = $\frac{\text{SFM}}{\text{DIAM. in.}} \times 3.82$ IPM = IPR x RPM

HOLE DEPTH in. x 60 = Cut Time IPM mm = in. x 25.40

m/min. = SFM ÷ 3.28 Bar = PSI ÷ 14.50
mm/rev. = IPR x 25.40 Liter = Gal. ÷ 3.79

Series # 5520

Material group	Hardness	SFM	Feed Rate - IPR										
			1/16 in. 1.590 mm	1/8 in. 3.170 mm	1/4 in. 6.350 mm	3/8 in. 9.520 mm	1/2 in. 12.700 mm	5/8 in. 15.870 mm	3/4 in. 19.050 mm	1 in. 25.400 mm	1 1/4 in. 31.750 mm	1 1/2 in. 38.100 mm	
Common structural steels	≤100 Bhn	160	0.0017	0.0050	0.0080	0.0100	0.0125	0.0125	•	•	•	•	•
	>100-260 Bhn	130	0.0015	0.0040	0.0065	0.0080	0.0100	0.0100	•	•	•	•	•
Free-cutting steels	≤24 Rc	195	0.0017	0.0050	0.0080	0.0100	0.0125	0.0125	•	•	•	•	•
	>24-30 Rc	160	0.0017	0.0050	0.0080	0.0100	0.0125	0.0125	•	•	•	•	•
Unalloyed heat-treatable steels	≤16 Rc	160	0.0017	0.0050	0.0080	0.0100	0.0125	0.0125	•	•	•	•	•
	16-24 Rc	130	0.0017	0.0050	0.0080	0.0100	0.0125	0.0125	•	•	•	•	•
	24-30 Rc	80	0.0015	0.0040	0.0065	0.0080	0.0100	0.0100	•	•	•	•	•
Alloyed heat-treatable steels	24-30 Rc	70	0.0012	0.0030	0.0050	0.0065	0.0080	0.0080	•	•	•	•	•
	>30-38 Rc	45	0.0010	0.0025	0.0040	0.0050	0.0065	0.0065	•	•	•	•	•
Unalloyed case hardened steels	≤230 Bhn	130	0.0017	0.0050	0.0080	0.0100	0.0125	0.0125	•	•	•	•	•
Alloyed case hardened steels	24-30 Rc	65	0.0012	0.0030	0.0050	0.0065	0.0080	0.0080	•	•	•	•	•
	>30-38 Rc	45	0.0010	0.0025	0.0040	0.0050	0.0065	0.0065	•	•	•	•	•
Nitriding steels	≥24-30 Rc	55	0.0012	0.0030	0.0050	0.0065	0.0080	0.0080	•	•	•	•	•
	>30-38 Rc	45	0.0010	0.0025	0.0040	0.0050	0.0065	0.0065	•	•	•	•	•
Tool steels	≤24 Rc	70	0.0012	0.0030	0.0050	0.0065	0.0080	0.0080	•	•	•	•	•
	>24-30 Rc	40	0.0010	0.0025	0.0040	0.0050	0.0065	0.0065	•	•	•	•	•
High speed steels	≥14-30 Rc	40	0.0010	0.0025	0.0040	0.0050	0.0065	0.0065	•	•	•	•	•
Spring steels	≤330 Bhn	•	•	•	•	•	•	•	•	•	•	•	•
Stainless steels, sulphured austenitic martensitic	≤24 Rc	65	0.0012	0.0030	0.0050	0.0065	0.0080	0.0080	•	•	•	•	•
	≤24 Rc	45	0.0012	0.0030	0.0050	0.0065	0.0080	0.0080	•	•	•	•	•
	≤24 Rc	55	0.0012	0.0030	0.0050	0.0065	0.0080	0.0080	•	•	•	•	•
Hardened steels	≤40-48 Rc	•	•	•	•	•	•	•	•	•	•	•	•
>48-60 Rc	•	•	•	•	•	•	•	•	•	•	•	•	•
Special alloys	≤38 Rc	•	•	•	•	•	•	•	•	•	•	•	•
Cast iron	≤240 Bhn	145	0.0017	0.0050	0.0080	0.0100	0.0125	0.0125	•	•	•	•	•
	<300 Bhn	115	0.0017	0.0050	0.0080	0.0100	0.0125	0.0125	•	•	•	•	•
Spheroidal graphite iron and malleable cast iron	≤240 Bhn	130	0.0017	0.0050	0.0080	0.0100	0.0125	0.0125	•	•	•	•	•
	<300 Bhn	100	0.0017	0.0050	0.0080	0.0100	0.0125	0.0125	•	•	•	•	•
Chilled cast iron	≤350 Bhn	•	•	•	•	•	•	•	•	•	•	•	•
Ti and Ti-alloys	≤24 Rc	•	•	•	•	•	•	•	•	•	•	•	•
>24-38 Rc	•	•	•	•	•	•	•	•	•	•	•	•	•
Aluminium and Al-alloys	≤120 Bhn	225	0.0020	0.0065	0.0100	0.0125	0.0160	0.0160	•	•	•	•	•
Al wrought alloys	≤150 Bhn	225	0.0020	0.0065	0.0100	0.0125	0.0160	0.0160	•	•	•	•	•
Al cast alloys ≤ 10 % Si > 10 % Si	≤200 Bhn	295	0.0020	0.0065	0.0100	0.0125	0.0160	0.0160	•	•	•	•	•
	≤200 Bhn	260	0.0017	0.0050	0.0080	0.0100	0.0125	0.0125	•	•	•	•	•
Magnesium alloys	≤150 Bhn	260	0.0017	0.0050	0.0080	0.0100	0.0125	0.0125	•	•	•	•	•
Copper, low-alloyed	≤120 Bhn	100	0.0015	0.0040	0.0065	0.0080	0.0100	0.0100	•	•	•	•	•
Brass, short-chipping long-chipping	≤200 Bhn	205	0.0015	0.0040	0.0065	0.0080	0.0100	0.0100	•	•	•	•	•
	≤200 Bhn	130	0.0015	0.0040	0.0065	0.0080	0.0100	0.0100	•	•	•	•	•
Bronze, short-chipping	≤200 Bhn	160	0.0012	0.0030	0.0050	0.0065	0.0080	0.0080	•	•	•	•	•
	>200-260 Bhn	95	0.0012	0.0030	0.0050	0.0065	0.0080	0.0080	•	•	•	•	•
Bronze, long-chipping	≤24 Rc	130	0.0012	0.0030	0.0050	0.0065	0.0080	0.0080	•	•	•	•	•
	>24-30 Rc	95	0.0012	0.0030	0.0050	0.0065	0.0080	0.0080	•	•	•	•	•
Duroplastics	-	80	0.0012	0.0030	0.0050	0.0065	0.0080	0.0080	•	•	•	•	•
Thermoplastics	-	80	0.0012	0.0030	0.0050	0.0065	0.0080	0.0080	•	•	•	•	•
Reinforced plastics - Kevlar	-	•	•	•	•	•	•	•	•	•	•	•	•
Reinforced plastics - GFK / CFK	-	•	•	•	•	•	•	•	•	•	•	•	•

Series # 5521

Material group	Hardness	SFM	Feed Rate - IPR										
			1/16 in. 1.590 mm	1/8 in. 3.170 mm	1/4 in. 6.350 mm	3/8 in. 9.520 mm	1/2 in. 12.700 mm	5/8 in. 15.870 mm	3/4 in. 19.050 mm	1 in. 25.400 mm	1 1/4 in. 31.750 mm	1 1/2 in. 38.100 mm	
Common structural steels	≤100 Bhn	130	0.0017	0.0050	0.0080	0.0100	0.0125	0.0125	•	•	•	•	•
	>100-260 Bhn	100	0.0015	0.0040	0.0065	0.0080	0.0100	0.0100	•	•	•	•	•
Free-cutting steels	≤24 Rc	155	0.0017	0.0050	0.0080	0.0100	0.0125	0.0125	•	•	•	•	•
	>24-30 Rc	125	0.0017	0.0050	0.0080	0.0100	0.0125	0.0125	•	•	•	•	•
Unalloyed heat-treatable steels	≤16 Rc	100	0.0017	0.0050	0.0080	0.0100	0.0125	0.0125	•	•	•	•	•
	16-24 Rc	100	0.0017	0.0050	0.0080	0.0100	0.0125	0.0125	•	•	•	•	•
	24-30 Rc	80	0.0015	0.0040	0.0065	0.0080	0.0100	0.0100	•	•	•	•	•
Alloyed heat-treatable steels	24-30 Rc	80	0.0012	0.0030	0.0050	0.0065	0.0080	0.0080	•	•	•	•	•
	>30-38 Rc	80	0.0012	0.0030	0.0050	0.0065	0.0080	0.0080	•	•	•	•	•
Unalloyed case hardened steels	≤230 Bhn	100	0.0010	0.0025	0.0040	0.0050	0.0065	0.0065	•	•	•	•	•
Alloyed case hardened steels	24-30 Rc	60	0.0012	0.0030	0.0050	0.0065	0.0080	0.0080	•	•	•	•	•
	>30-38 Rc	50	0.0010	0.0025	0.0040	0.0050	0.0065	0.0065	•	•	•	•	•
Nitriding steels	≥24-30 Rc	45	0.0012	0.0030	0.0050	0.0065	0.0080	0.0080	•	•	•	•	•
	>30-38 Rc	50	0.0010	0.0025	0.0040	0.0050	0.0065	0.0065	•	•	•	•	•
Tool steels	≤24 Rc	60	0.0012	0.0030	0.0050	0.0065	0.0080	0.0080	•	•	•	•	•
	>24-30 Rc	50	0.0010	0.0025	0.0040	0.0050	0.0065	0.0065	•	•	•	•	•
High speed steels	≥14-30 Rc	50	0.0010	0.0025	0.0040	0.0050	0.0065	0.0065	•	•	•	•	•
Spring steels	≤330 Bhn	30	0.0007	0.0020	0.0030	0.0040	0.0050	0.0050	•	•	•	•	•
Stainless steels, sulphured austenitic martensitic	≤24 Rc	50	0.0012	0.0030	0.0050	0.0065	0.0080	0.0080	•	•	•	•	•
	≤24 Rc	35	0.0010	0.0025	0.0040	0.0050	0.0065	0.0065	•	•	•	•	•
	≤24 Rc	50	0.0010	0.0025	0.0040	0.0050	0.0065	0.0065	•	•	•	•	•
Hardened steels	≤40-48 Rc	•	•	•	•	•	•	•	•	•	•	•	•
>48-60 Rc	•	•	•	•	•	•	•	•	•	•	•	•	•
Special alloys	≤38 Rc	30	0.0007	0.0020	0.0030	0.0040	0.0050	0.0050	•	•	•	•	•
Cast iron	≤240 Bhn	115	0.0017	0.0050	0.0080	0.0100	0.0125	0.0125	•	•	•	•	•
	<300 Bhn	90	0.0017	0.0050	0.0080	0.0100	0.0125	0.0125	•	•	•	•	•
Spheroidal graphite iron and malleable cast iron	≤240 Bhn	100	0.0017	0.0050	0.0080	0.0100	0.0125	0.0125	•	•	•	•	•
	<300 Bhn	80	0.0017	0.0050	0.0080	0.0100	0.0125	0.0125	•	•	•	•	•
Chilled cast iron	≤350 Bhn	•	•	•	•	•	•	•	•	•	•	•	•
Ti and Ti-alloys	≤24 Rc	•	•	•	•	•	•	•	•	•	•	•	•
>24-38 Rc	•	•	•	•	•	•	•	•	•	•	•	•	•
Aluminium and Al-alloys	≤120 Bhn	•	•	•	•	•	•	•	•	•	•	•	•
Al wrought alloys	≤150 Bhn	•	•	•	•	•	•	•	•	•	•	•	•
Al cast alloys ≤ 10 % Si > 10 % Si	≤200 Bhn	230	0.0020	0.0065	0.0100	0.0125	0.0160	0.0160	•	•	•	•	•
	≤200 Bhn	185	0.0017	0.0050	0.0080	0.0100	0.0125	0.0125	•	•	•	•	•
Magnesium alloys	≤150 Bhn	205	0.0017	0.0050	0.0080	0.0100	0.0125	0.0125	•	•	•	•	•
Copper, low-alloyed	≤120 Bhn	•	•	•	•	•	•	•	•	•	•	•	•
Brass, short-chipping long-chipping	≤200 Bhn	•	•	•	•	•	•	•	•	•	•	•	•
	≤200 Bhn	•	•	•	•	•	•	•	•	•	•	•	•
Bronze, short-chipping	≤200 Bhn	•	•	•	•	•	•	•	•	•	•	•	•
	>200-260 Bhn	•	•	•	•	•	•	•	•	•	•	•	•
Bronze, long-chipping	≤24 Rc	•	•	•	•	•	•	•	•	•	•	•	•
	>24-30 Rc	•	•	•	•	•	•	•	•	•	•	•	•
Duroplastics	-	•	•	•	•	•	•	•	•	•	•	•	•
Thermoplastics	-	•	•	•	•	•	•	•	•	•	•	•	•
Reinforced plastics - Kevlar	-	•	•	•	•	•	•	•	•	•	•	•	•
Reinforced plastics - GFK / CFK	-	•	•	•	•	•	•	•	•	•	•	•	•

Series # 5522

Material group	Hardness	SFM	Feed Rate - IPR									
			1/16 in. 1.590 mm	1/8 in. 3.170 mm	1/4 in. 6.350 mm	3/8 in. 9.520 mm	1/2 in. 12.700 mm	5/8 in. 15.870 mm	3/4 in. 19.050 mm	1 in. 25.400 mm	1 1/4 in. 31.750 mm	1 1/2 in. 38.100 mm
Common structural steels	≤100 Bhn	130	0.0017	0.0050	0.0080	0.0100	0.0125	0.0125	*	*	*	*
	>100-260 Bhn	100	0.0015	0.0040	0.0065	0.0080	0.0100	0.0100	*	*	*	*
Free-cutting steels	≤24 Rc	155	0.0017	0.0050	0.0080	0.0100	0.0125	0.0125	*	*	*	*
	>24-30 Rc	125	0.0017	0.0050	0.0080	0.0100	0.0125	0.0125	*	*	*	*
Unalloyed heat-treatable steels	≤16 Rc	100	0.0017	0.0050	0.0080	0.0100	0.0125	0.0125	*	*	*	*
	16-24 Rc	100	0.0017	0.0050	0.0080	0.0100	0.0125	0.0125	*	*	*	*
	24-30 Rc	80	0.0015	0.0040	0.0065	0.0080	0.0100	0.0100	*	*	*	*
Alloyed heat-treatable steels	24-30 Rc	80	0.0012	0.0030	0.0050	0.0065	0.0080	0.0080	*	*	*	*
	>30-38 Rc	80	0.0012	0.0030	0.0050	0.0065	0.0080	0.0080	*	*	*	*
Unalloyed case hardened steels	≤230 Bhn	100	0.0010	0.0025	0.0040	0.0050	0.0065	0.0065	*	*	*	*
Alloyed case hardened steels	24-30 Rc	60	0.0012	0.0030	0.0050	0.0065	0.0080	0.0080	*	*	*	*
	>30-38 Rc	50	0.0010	0.0025	0.0040	0.0050	0.0065	0.0065	*	*	*	*
Nitriding steels	≥24-30 Rc	45	0.0012	0.0030	0.0050	0.0065	0.0080	0.0080	*	*	*	*
	>30-38 Rc	50	0.0010	0.0025	0.0040	0.0050	0.0065	0.0065	*	*	*	*
Tool steels	≤24 Rc	60	0.0012	0.0030	0.0050	0.0065	0.0080	0.0080	*	*	*	*
	>24-30 Rc	50	0.0010	0.0025	0.0040	0.0050	0.0065	0.0065	*	*	*	*
High speed steels	≥14-30 Rc	50	0.0010	0.0025	0.0040	0.0050	0.0065	0.0065	*	*	*	*
Spring steels	≤330 Bhn	30	0.0007	0.0020	0.0030	0.0040	0.0050	0.0050	*	*	*	*
Stainless steels, sulphured austenitic martensitic	≤24 Rc	50	0.0012	0.0030	0.0050	0.0065	0.0080	0.0080	*	*	*	*
	≤24 Rc	35	0.0010	0.0025	0.0040	0.0050	0.0065	0.0065	*	*	*	*
	≤24 Rc	50	0.0010	0.0025	0.0040	0.0050	0.0065	0.0065	*	*	*	*
Hardened steels	≤40-48 Rc	*	*	*	*	*	*	*	*	*	*	*
	>48-60 Rc	*	*	*	*	*	*	*	*	*	*	*
Special alloys	≤38 Rc	30	0.0007	0.0020	0.0030	0.0040	0.0050	0.0050	*	*	*	*
Cast iron	≤240 Bhn	115	0.0017	0.0050	0.0080	0.0100	0.0125	0.0125	*	*	*	*
	<300 Bhn	90	0.0017	0.0050	0.0080	0.0100	0.0125	0.0125	*	*	*	*
Spheroidal graphite iron and malleable cast iron	≤240 Bhn	100	0.0017	0.0050	0.0080	0.0100	0.0125	0.0125	*	*	*	*
	<300 Bhn	80	0.0017	0.0050	0.0080	0.0100	0.0125	0.0125	*	*	*	*
Chilled cast iron	≤350 Bhn	*	*	*	*	*	*	*	*	*	*	
Ti and Ti-alloys	≤24 Rc	*	*	*	*	*	*	*	*	*	*	*
	>24-38 Rc	*	*	*	*	*	*	*	*	*	*	*
Aluminium and Al-alloys	≤120 Bhn	*	*	*	*	*	*	*	*	*	*	
Al wrought alloys	≤150 Bhn	*	*	*	*	*	*	*	*	*	*	*
	Al cast alloys ≤ 10 % Si > 10 % Si	230 185	0.0020 0.0017	0.0065 0.0050	0.0100 0.0080	0.0125 0.0100	0.0160 0.0125	0.0160 0.0125	*	*	*	*
Magnesium alloys	≤150 Bhn	205	0.0017	0.0050	0.0080	0.0100	0.0125	0.0125	*	*	*	*
Copper, low-alloyed	≤120 Bhn	*	*	*	*	*	*	*	*	*	*	
Brass, short-chipping long-chipping	≤200 Bhn	*	*	*	*	*	*	*	*	*	*	
	≤200 Bhn	*	*	*	*	*	*	*	*	*	*	
Bronze, short-chipping	≤200 Bhn	*	*	*	*	*	*	*	*	*	*	
	>200-260 Bhn	*	*	*	*	*	*	*	*	*	*	
Bronze, long-chipping	≤24 Rc	*	*	*	*	*	*	*	*	*	*	
	>24-30 Rc	*	*	*	*	*	*	*	*	*	*	
Duroplastics	-	*	*	*	*	*	*	*	*	*	*	
Thermoplastics	-	*	*	*	*	*	*	*	*	*	*	
Reinforced plastics - Kevlar	-	*	*	*	*	*	*	*	*	*	*	
Reinforced plastics - GFK / CFK	-	*	*	*	*	*	*	*	*	*	*	

Series # 5523

Material group	Hardness	SFM	Feed Rate - IPR									
			1/16 in. 1.590 mm	1/8 in. 3.170 mm	1/4 in. 6.350 mm	3/8 in. 9.520 mm	1/2 in. 12.700 mm	5/8 in. 15.870 mm	3/4 in. 19.050 mm	1 in. 25.400 mm	1 1/4 in. 31.750 mm	1 1/2 in. 38.100 mm
Common structural steels	≤100 Bhn	130	0.0017	0.0050	0.0080	0.0100	0.0125	0.0125	*	*	*	*
	>100-260 Bhn	100	0.0015	0.0040	0.0065	0.0080	0.0100	0.0100	*	*	*	*
Free-cutting steels	≤24 Rc	155	0.0017	0.0050	0.0080	0.0100	0.0125	0.0125	*	*	*	*
	>24-30 Rc	125	0.0017	0.0050	0.0080	0.0100	0.0125	0.0125	*	*	*	*
Unalloyed heat-treatable steels	≤16 Rc	130	0.0017	0.0050	0.0080	0.0100	0.0125	0.0125	*	*	*	*
	16-24 Rc	100	0.0017	0.0050	0.0080	0.0100	0.0125	0.0125	*	*	*	*
	24-30 Rc	65	0.0015	0.0040	0.0065	0.0080	0.0100	0.0100	*	*	*	*
Alloyed heat-treatable steels	24-30 Rc	55	0.0012	0.0030	0.0050	0.0065	0.0080	0.0080	*	*	*	*
	>30-38 Rc	35	0.0010	0.0025	0.0040	0.0050	0.0065	0.0065	*	*	*	*
Unalloyed case hardened steels	≤230 Bhn	100	0.0017	0.0050	0.0080	0.0100	0.0125	0.0125	*	*	*	*
Alloyed case hardened steels	24-30 Rc	50	0.0012	0.0030	0.0050	0.0065	0.0080	0.0080	*	*	*	*
	>30-38 Rc	35	0.0010	0.0025	0.0040	0.0050	0.0065	0.0065	*	*	*	*
Nitriding steels	≥24-30 Rc	45	0.0012	0.0030	0.0050	0.0065	0.0080	0.0080	*	*	*	*
	>30-38 Rc	35	0.0010	0.0025	0.0040	0.0050	0.0065	0.0065	*	*	*	*
Tool steels	≤24 Rc	55	0.0012	0.0030	0.0050	0.0065	0.0080	0.0080	*	*	*	*
	>24-30 Rc	30	0.0010	0.0025	0.0040	0.0050	0.0065	0.0065	*	*	*	*
High speed steels	≥14-30 Rc	30	0.0010	0.0025	0.0040	0.0050	0.0065	0.0065	*	*	*	*
Spring steels	≤330 Bhn	*	*	*	*	*	*	*	*	*	*	
Stainless steels, sulphured austenitic martensitic	≤24 Rc	50	0.0012	0.0030	0.0050	0.0065	0.0080	0.0080	*	*	*	*
	≤24 Rc	35	0.0012	0.0030	0.0050	0.0065	0.0080	0.0080	*	*	*	*
	≤24 Rc	45	0.0012	0.0030	0.0050	0.0065	0.0080	0.0080	*	*	*	*
Hardened steels	≤40-48 Rc	*	*	*	*	*	*	*	*	*	*	*
	>48-60 Rc	*	*	*	*	*	*	*	*	*	*	*
Special alloys	≤38 Rc	*	*	*	*	*	*	*	*	*	*	
Cast iron	≤240 Bhn	115	0.0017	0.0050	0.0080	0.0100	0.0125	0.0125	*	*	*	*
	<300 Bhn	90	0.0017	0.0050	0.0080	0.0100	0.0125	0.0125	*	*	*	*
Spheroidal graphite iron and malleable cast iron	≤240 Bhn	100	0.0017	0.0050	0.0080	0.0100	0.0125	0.0125	*	*	*	*
	<300 Bhn	80	0.0017	0.0050	0.0080	0.0100	0.0125	0.0125	*	*	*	*
Chilled cast iron	≤350 Bhn	*	*	*	*	*	*	*	*	*	*	
Ti and Ti-alloys	≤24 Rc	*	*	*	*	*	*	*	*	*	*	*
	>24-38 Rc	*	*	*	*	*	*	*	*	*	*	*
Aluminium and Al-alloys	≤120 Bhn	180	0.0020	0.0065	0.0100	0.0125	0.0160	0.0160	*	*	*	*
Al wrought alloys	≤150 Bhn	180	0.0020	0.0065	0.0100	0.0125	0.0160	0.0160	*	*	*	*
	Al cast alloys ≤ 10 % Si > 10 % Si	230 185	0.0020 0.0017	0.0065 0.0050	0.0100 0.0080	0.0125 0.0100	0.0160 0.0125	0.0160 0.0125	*	*	*	*
Magnesium alloys	≤150 Bhn	205	0.0017	0.0050	0.0080	0.0100	0.0125	0.0125	*	*	*	*
Copper, low-alloyed	≤120 Bhn	80	0.0015	0.0040	0.0065	0.0080	0.0100	0.0100	*	*	*	*
Brass, short-chipping long-chipping	≤200 Bhn	165	0.0015	0.0040	0.0065	0.0080	0.0100	0.0100	*	*	*	*
	≤200 Bhn	100	0.0015	0.0040	0.0065	0.0080	0.0100	0.0100	*	*	*	*
Bronze, short-chipping	≤200 Bhn	130	0.0012	0.0030	0.0050	0.0065	0.0080	0.0080	*	*	*	*
	>200-260 Bhn	75	0.0012	0.0030	0.0050	0.0065	0.0080	0.0080	*	*	*	*
Bronze, long-chipping	≤24 Rc	100	0.0012	0.0030	0.0050	0.0065	0.0080	0.0080	*	*	*	*
	>24-30 Rc	75	0.0012	0.0030	0.0050	0.0065	0.0080	0.0080	*	*	*	*
Duroplastics	-	65	0.0012	0.0030	0.0050	0.0065	0.0080	0.0080	*	*	*	*
Thermoplastics	-	65	0.0012	0.0030	0.0050	0.0065	0.0080	0.0080	*	*	*	*
Reinforced plastics - Kevlar	-	*	*	*	*	*	*	*	*	*	*	
Reinforced plastics - GFK / CFK	-	*	*	*	*	*	*	*	*	*	*	

Using These Tables. The Speeds & Feeds listed below are conservative recommendations for initial setup. In actual use, depending on the machining environment and workpiece material, significantly higher speeds and feeds may be achievable. Using the below as a starting point, cutting speed/feed can be gradually adjusted upwards until the optimum settings per application are found.
 Questions? Contact us by telephone at (800) 776-6170.

Series # 5536

Material group	Hardness	SFM	Feed Rate - IPR										
			1/16 in. 1.590 mm	1/8 in. 3.170 mm	1/4 in. 6.350 mm	3/8 in. 9.520 mm	1/2 in. 12.700 mm	5/8 in. 15.870 mm	3/4 in. 19.050 mm	1 in. 25.400 mm	1 1/4 in. 31.750 mm	1 1/2 in. 38.100 mm	
Common structural steels	≤100 Bhn >100-260 Bhn	•	•	•	•	•	•	•	•	•	•	•	•
Free-cutting steels	≤24 Rc >24-30 Rc	•	•	•	•	•	•	•	•	•	•	•	•
Unalloyed heat-treatable steels	≤16 Rc 16-24 Rc 24-30 Rc	•	•	•	•	•	•	•	•	•	•	•	•
Alloyed heat-treatable steels	24-30 Rc >30-38 Rc	35	0.0010	0.0025	0.0040	0.0050	0.0065	•	•	•	•	•	•
Unalloyed case hardened steels	≤230 Bhn	•	•	•	•	•	•	•	•	•	•	•	•
Alloyed case hardened steels	24-30 Rc >30-38 Rc	•	•	•	•	•	•	•	•	•	•	•	•
Nitriding steels	≥24-30 Rc >30-38 Rc	•	•	•	•	•	•	•	•	•	•	•	•
Tool steels	≤24 Rc >24-30 Rc	•	•	•	•	•	•	•	•	•	•	•	•
High speed steels	≥14-30 Rc	•	•	•	•	•	•	•	•	•	•	•	•
Spring steels	≤330 Bhn	•	•	•	•	•	•	•	•	•	•	•	•
Stainless steels, sulphured austenitic martensitic	≤24 Rc 25 ≥24 Rc	35 25 30	0.0012 0.0010 0.0010	0.0030 0.0025 0.0025	0.0050 0.0040 0.0040	0.0065 0.0050 0.0050	0.0080 0.0065 0.0065	•	•	•	•	•	•
Hardened steels	≤40-48 Rc >48-60 Rc	•	•	•	•	•	•	•	•	•	•	•	•
Special alloys	≤38 Rc	15	0.0005	0.0015	0.0025	0.0030	0.0040	•	•	•	•	•	•
Cast iron	≤240 Bhn <300 Bhn	•	•	•	•	•	•	•	•	•	•	•	•
Spheroidal graphite iron and malleable cast iron	≤240 Bhn <300 Bhn	•	•	•	•	•	•	•	•	•	•	•	•
Chilled cast iron	≤350 Bhn	15	0.0010	0.0025	0.0040	0.0050	0.0065	•	•	•	•	•	•
Ti and Ti-alloys	≤24 Rc >24-38 Rc	25 15	0.0007 0.0007	0.0020 0.0020	0.0030 0.0030	0.0040 0.0040	0.0050 0.0050	•	•	•	•	•	•
Aluminium and Al-alloys	≤120 Bhn	•	•	•	•	•	•	•	•	•	•	•	•
Al wrought alloys	≤150 Bhn	•	•	•	•	•	•	•	•	•	•	•	•
Al cast alloys ≤ 10 % Si > 10 % Si	≤200 Bhn ≤200 Bhn	•	•	•	•	•	•	•	•	•	•	•	•
Magnesium alloys	≤150 Bhn	•	•	•	•	•	•	•	•	•	•	•	•
Copper, low-alloyed	≤120 Bhn	•	•	•	•	•	•	•	•	•	•	•	•
Brass, short-chipping long-chipping	≤200 Bhn ≤200 Bhn	•	•	•	•	•	•	•	•	•	•	•	•
Bronze, short-chipping	≤200 Bhn	•	•	•	•	•	•	•	•	•	•	•	•
Bronze, long-chipping	≤24 Rc >24-30 Rc	•	•	•	•	•	•	•	•	•	•	•	•
Duroplastics Thermoplastics	- -	65	0.0012	0.0030	0.0050	0.0065	0.0080	•	•	•	•	•	•
Reinforced plastics - Kevlar Reinforced plastics - GFK / CFK	- -	•	•	•	•	•	•	•	•	•	•	•	•

Series # 5537

Material group	Hardness	SFM	Feed Rate - IPR										
			1/16 in. 1.590 mm	1/8 in. 3.170 mm	1/4 in. 6.350 mm	3/8 in. 9.520 mm	1/2 in. 12.700 mm	5/8 in. 15.870 mm	3/4 in. 19.050 mm	1 in. 25.400 mm	1 1/4 in. 31.750 mm	1 1/2 in. 38.100 mm	
Common structural steels	≤100 Bhn >100-260 Bhn	•	•	•	•	•	•	•	•	•	•	•	•
Free-cutting steels	≤24 Rc >24-30 Rc	•	•	•	•	•	•	•	•	•	•	•	•
Unalloyed heat-treatable steels	≤16 Rc 16-24 Rc 24-30 Rc	•	•	•	•	•	•	•	•	•	•	•	•
Alloyed heat-treatable steels	24-30 Rc >30-38 Rc	45	0.0010	0.0025	0.0040	0.0050	0.0065	•	•	•	•	•	•
Unalloyed case hardened steels	≤230 Bhn	•	•	•	•	•	•	•	•	•	•	•	•
Alloyed case hardened steels	24-30 Rc >30-38 Rc	40	0.0010	0.0025	0.0040	0.0050	0.0065	•	•	•	•	•	•
Nitriding steels	≥24-30 Rc >30-38 Rc	30	0.0010	0.0025	0.0040	0.0050	0.0065	•	•	•	•	•	•
Tool steels	≤24 Rc >24-30 Rc	30	0.0010	0.0025	0.0040	0.0050	0.0065	•	•	•	•	•	•
High speed steels	≥14-30 Rc	30	0.0010	0.0025	0.0040	0.0050	0.0065	•	•	•	•	•	•
Spring steels	≤330 Bhn	25	0.0007	0.0020	0.0030	0.0040	0.0050	•	•	•	•	•	•
Stainless steels, sulphured austenitic martensitic	≤24 Rc 30 ≥24 Rc	45 30 40	0.0012 0.0010 0.0010	0.0030 0.0025 0.0025	0.0050 0.0040 0.0040	0.0065 0.0050 0.0050	0.0080 0.0065 0.0065	•	•	•	•	•	•
Hardened steels	≤40-48 Rc >48-60 Rc	5	0.0005	0.0015	0.0025	0.0030	0.0040	•	•	•	•	•	•
Special alloys	≤38 Rc	15	0.0005	0.0015	0.0025	0.0030	0.0040	•	•	•	•	•	•
Cast iron	≤240 Bhn <300 Bhn	•	•	•	•	•	•	•	•	•	•	•	•
Spheroidal graphite iron and malleable cast iron	≤240 Bhn <300 Bhn	•	•	•	•	•	•	•	•	•	•	•	•
Chilled cast iron	≤350 Bhn	15	0.0010	0.0025	0.0040	0.0050	0.0065	•	•	•	•	•	•
Ti and Ti-alloys	≤24 Rc >24-38 Rc	30 15	0.0007 0.0007	0.0020 0.0020	0.0030 0.0030	0.0040 0.0040	0.0050 0.0050	•	•	•	•	•	•
Aluminium and Al-alloys	≤120 Bhn	•	•	•	•	•	•	•	•	•	•	•	•
Al wrought alloys	≤150 Bhn	•	•	•	•	•	•	•	•	•	•	•	•
Al cast alloys ≤ 10 % Si > 10 % Si	≤200 Bhn ≤200 Bhn	•	•	•	•	•	•	•	•	•	•	•	•
Magnesium alloys	≤150 Bhn	•	•	•	•	•	•	•	•	•	•	•	•
Copper, low-alloyed	≤120 Bhn	•	•	•	•	•	•	•	•	•	•	•	•
Brass, short-chipping long-chipping	≤200 Bhn ≤200 Bhn	•	•	•	•	•	•	•	•	•	•	•	•
Bronze, short-chipping	≤200 Bhn	•	•	•	•	•	•	•	•	•	•	•	•
Bronze, long-chipping	≤24 Rc >24-30 Rc	80	0.0012	0.0030	0.0050	0.0065	0.0080	•	•	•	•	•	•
Duroplastics Thermoplastics	- -	•	•	•	•	•	•	•	•	•	•	•	•
Reinforced plastics - Kevlar Reinforced plastics - GFK / CFK	- -	•	•	•	•	•	•	•	•	•	•	•	•

RPM = $\frac{SFM}{DIAM. \text{ in.}} \times 3.82$ IPM = IPR x RPM

HOLE DEPTH in. x 60 = Cut Time
IPM

mm = in. x 25.40

m/min. = SFM ÷ 3.28
mm/rev. = IPR x 25.40

Bar = PSI ÷ 14.50
Liter = Gal. ÷ 3.79

Series # 5610

Material group	Hardness	SFM	Feed Rate - IPR												
			1/16 in. 1.590 mm	1/8 in. 3.170 mm	1/4 in. 6.350 mm	3/8 in. 9.520 mm	1/2 in. 12.700 mm	5/8 in. 15.870 mm	3/4 in. 19.050 mm	1 in. 25.400 mm	1 1/4 in. 31.750 mm	1 1/2 in. 38.100 mm			
Common structural steels	≤100 Bhn >100-260 Bhn	475 395	•	•	•	•	•	•	•	•	•	•	•	•	•
Free-cutting steels	≤24 Rc >24-30 Rc	560 475	•	•	•	•	•	•	•	•	•	•	•	•	•
Unalloyed heat-treatable steels	≤16 Rc 16-24 Rc 24-30 Rc	425 410 395	•	•	•	•	•	•	•	•	•	•	•	•	•
Alloyed heat-treatable steels	24-30 Rc >30-38 Rc	395 345	•	•	•	•	•	•	•	•	•	•	•	•	•
Unalloyed case hardened steels	≤230 Bhn	475	•	•	•	•	•	•	•	•	•	•	•	•	•
Alloyed case hardened steels	24-30 Rc >30-38 Rc	395 280	•	•	•	•	•	•	•	•	•	•	•	•	•
Nitriding steels	≥24-30 Rc >30-38 Rc	360 345	•	•	•	•	•	•	•	•	•	•	•	•	•
Tool steels	≤24 Rc >24-30 Rc	260 215	•	•	•	•	•	•	•	•	•	•	•	•	•
High speed steels	≥14-30 Rc	195	•	•	•	•	•	•	•	•	•	•	•	•	•
Spring steels	≤330 Bhn	195	•	•	•	•	•	•	•	•	•	•	•	•	•
Stainless steels, sulphured austenitic martensitic	≤24 Rc ≤24 Rc ≤24 Rc	195 180 165	•	•	•	•	•	•	•	•	•	•	•	•	•
Hardened steels	≤40-48 Rc >48-60 Rc	180 115	•	•	•	•	•	•	•	•	•	•	•	•	•
Special alloys	≤38 Rc	115	•	•	•	•	•	•	•	•	•	•	•	•	•
Cast iron	≤240 Bhn <300 Bhn	690 525	•	•	•	•	•	•	•	•	•	•	•	•	•
Spheroidal graphite iron and malleable cast iron	≤240 Bhn <300 Bhn	460 425	•	•	•	•	•	•	•	•	•	•	•	•	•
Chilled cast iron	≤350 Bhn	130	•	•	•	•	•	•	•	•	•	•	•	•	•
Ti and Ti-alloys	≤24 Rc >24-38 Rc	150 130	•	•	•	•	•	•	•	•	•	•	•	•	•
Aluminium and Al-alloys	≤120 Bhn	1015	•	•	•	•	•	•	•	•	•	•	•	•	•
Al wrought alloys	≤150 Bhn	1015	•	•	•	•	•	•	•	•	•	•	•	•	•
Al cast alloys ≤ 10 % Si > 10 % Si	≤200 Bhn ≤200 Bhn	855 720	•	•	•	•	•	•	•	•	•	•	•	•	•
Magnesium alloys	≤150 Bhn	920	•	•	•	•	•	•	•	•	•	•	•	•	•
Copper, low-alloyed	≤120 Bhn	410	•	•	•	•	•	•	•	•	•	•	•	•	•
Brass, short-chipping long-chipping	≤200 Bhn ≤200 Bhn	1065 720	•	•	•	•	•	•	•	•	•	•	•	•	•
Bronze, short-chipping	≤200 Bhn >200-260 Bhn	410 345	•	•	•	•	•	•	•	•	•	•	•	•	•
Bronze, long-chipping	≤24 Rc >24-30 Rc	295 260	•	•	•	•	•	•	•	•	•	•	•	•	•
Duroplastics	-	-	•	•	•	•	•	•	•	•	•	•	•	•	•
Thermoplastics	-	-	•	•	•	•	•	•	•	•	•	•	•	•	•
Reinforced plastics - Kevlar	-	-	•	•	•	•	•	•	•	•	•	•	•	•	•
Reinforced plastics - GFK / CFK	-	-	•	•	•	•	•	•	•	•	•	•	•	•	•

Series # 5611

Material group	Hardness	SFM	Feed Rate - IPR												
			1/16 in. 1.590 mm	1/8 in. 3.170 mm	1/4 in. 6.350 mm	3/8 in. 9.520 mm	1/2 in. 12.700 mm	5/8 in. 15.870 mm	3/4 in. 19.050 mm	1 in. 25.400 mm	1 1/4 in. 31.750 mm	1 1/2 in. 38.100 mm			
Common structural steels	≤100 Bhn >100-260 Bhn	475 395	•	•	•	•	•	•	•	•	•	•	•	•	•
Free-cutting steels	≤24 Rc >24-30 Rc	560 475	•	•	•	•	•	•	•	•	•	•	•	•	•
Unalloyed heat-treatable steels	≤16 Rc 16-24 Rc 24-30 Rc	425 410 395	•	•	•	•	•	•	•	•	•	•	•	•	•
Alloyed heat-treatable steels	24-30 Rc >30-38 Rc	395 345	•	•	•	•	•	•	•	•	•	•	•	•	•
Unalloyed case hardened steels	≤230 Bhn	475	•	•	•	•	•	•	•	•	•	•	•	•	•
Alloyed case hardened steels	24-30 Rc >30-38 Rc	395 280	•	•	•	•	•	•	•	•	•	•	•	•	•
Nitriding steels	≥24-30 Rc >30-38 Rc	350 330	•	•	•	•	•	•	•	•	•	•	•	•	•
Tool steels	≤24 Rc >24-30 Rc	240 180	•	•	•	•	•	•	•	•	•	•	•	•	•
High speed steels	≥14-30 Rc	195	•	•	•	•	•	•	•	•	•	•	•	•	•
Spring steels	≤330 Bhn	195	•	•	•	•	•	•	•	•	•	•	•	•	•
Stainless steels, sulphured austenitic martensitic	≤24 Rc ≤24 Rc ≤24 Rc	195 180 165	•	•	•	•	•	•	•	•	•	•	•	•	•
Hardened steels	≤40-48 Rc >48-60 Rc	180 115	•	•	•	•	•	•	•	•	•	•	•	•	•
Special alloys	≤38 Rc	115	•	•	•	•	•	•	•	•	•	•	•	•	•
Cast iron	≤240 Bhn <300 Bhn	690 525	•	•	•	•	•	•	•	•	•	•	•	•	•
Spheroidal graphite iron and malleable cast iron	≤240 Bhn <300 Bhn	450 425	•	•	•	•	•	•	•	•	•	•	•	•	•
Chilled cast iron	≤350 Bhn	130	•	•	•	•	•	•	•	•	•	•	•	•	•
Ti and Ti-alloys	≤24 Rc >24-38 Rc	150 130	•	•	•	•	•	•	•	•	•	•	•	•	•
Aluminium and Al-alloys	≤120 Bhn	1015	•	•	•	•	•	•	•	•	•	•	•	•	•
Al wrought alloys	≤150 Bhn	1015	•	•	•	•	•	•	•	•	•	•	•	•	•
Al cast alloys ≤ 10 % Si > 10 % Si	≤200 Bhn ≤200 Bhn	855 720	•	•	•	•	•	•	•	•	•	•	•	•	•
Magnesium alloys	≤150 Bhn	920	•	•	•	•	•	•	•	•	•	•	•	•	•
Copper, low-alloyed	≤120 Bhn	410	•	•	•	•	•	•	•	•	•	•	•	•	•
Brass, short-chipping long-chipping	≤200 Bhn ≤200 Bhn	1065 720	•	•	•	•	•	•	•	•	•	•	•	•	•
Bronze, short-chipping	≤200 Bhn >200-260 Bhn	410 345	•	•	•	•	•	•	•	•	•	•	•	•	•
Bronze, long-chipping	≤24 Rc >24-30 Rc	295 260	•	•	•	•	•	•	•	•	•	•	•	•	•
Duroplastics	-	-	•	•	•	•	•	•	•	•	•	•	•	•	•
Thermoplastics	-	-	•	•	•	•	•	•	•	•	•	•	•	•	•
Reinforced plastics - Kevlar	-	-	•	•	•	•	•	•	•	•	•	•	•	•	•
Reinforced plastics - GFK / CFK	-	-	•	•	•	•	•	•	•	•	•	•	•	•	•

Series # 5612

Material group	Hardness	SFM	Feed Rate - IPR									
			1/16 in. 1.590 mm	1/8 in. 3.170 mm	1/4 in. 6.350 mm	3/8 in. 9.520 mm	1/2 in. 12.700 mm	5/8 in. 15.870 mm	3/4 in. 19.050 mm	1 in. 25.400 mm	1 1/4 in. 31.750 mm	1 1/2 in. 38.100 mm
Common structural steels	≤100 Bhn	460	•	0.0050	0.0080	0.0100	0.0125	0.0125	0.0140	0.0160	•	•
	>100-260 Bhn	395	•	0.0040	0.0065	0.0080	0.0100	0.0100	0.0110	0.0125	•	•
Free-cutting steels	≤24 Rc	550	•	0.0065	0.0100	0.0125	0.0160	0.0160	0.0180	0.0200	•	•
	>24-30 Rc	480	•	0.0065	0.0100	0.0125	0.0160	0.0160	0.0180	0.0200	•	•
Unalloyed heat-treatable steels	≤16 Rc	415	•	0.0065	0.0100	0.0125	0.0160	0.0160	0.0180	0.0200	•	•
	16-24 Rc	400	•	0.0050	0.0080	0.0100	0.0125	0.0125	0.0140	0.0160	•	•
	24-30 Rc	395	•	0.0050	0.0080	0.0100	0.0125	0.0125	0.0140	0.0160	•	•
Alloyed heat-treatable steels	24-30 Rc	395	•	0.0050	0.0080	0.0100	0.0125	0.0125	0.0140	0.0160	•	•
	>30-38 Rc	335	•	0.0050	0.0080	0.0100	0.0125	0.0125	0.0140	0.0160	•	•
Unalloyed case hardened steels	≤230 Bhn	465	•	0.0065	0.0100	0.0125	0.0160	0.0160	0.0180	0.0200	•	•
Alloyed case hardened steels	24-30 Rc	395	•	0.0050	0.0080	0.0100	0.0125	0.0125	0.0140	0.0160	•	•
	>30-38 Rc	270	•	0.0030	0.0050	0.0065	0.0080	0.0080	0.0090	0.0100	•	•
Nitriding steels	≥24-30 Rc	340	•	0.0050	0.0080	0.0100	0.0125	0.0125	0.0140	0.0160	•	•
	>30-38 Rc	325	•	0.0040	0.0065	0.0080	0.0100	0.0100	0.0110	0.0125	•	•
Tool steels	≤24 Rc	230	•	0.0040	0.0065	0.0080	0.0100	0.0100	0.0110	0.0125	•	•
	>24-30 Rc	175	•	0.0030	0.0050	0.0065	0.0080	0.0080	0.0090	0.0100	•	•
High speed steels	≥14-30 Rc	195	•	0.0025	0.0040	0.0050	0.0065	0.0065	0.0070	0.0080	•	•
Spring steels	≤330 Bhn	195	•	0.0020	0.0030	0.0040	0.0050	0.0050	0.0055	0.0065	•	•
Stainless steels, sulphured	≤24 Rc	195	•	0.0030	0.0050	0.0065	0.0080	0.0080	0.0090	0.0100	•	•
austenitic	≤24 Rc	175	•	0.0030	0.0050	0.0065	0.0080	0.0080	0.0090	0.0100	•	•
martensitic	≤24 Rc	155	•	0.0030	0.0050	0.0065	0.0080	0.0080	0.0090	0.0100	•	•
Hardened steels	≤40-48 Rc	175	•	0.0020	0.0030	0.0040	0.0050	0.0050	0.0055	0.0065	•	•
	>48-60 Rc	110	•	0.0020	0.0030	0.0040	0.0050	0.0050	0.0055	0.0065	•	•
Special alloys	≤38 Rc	110	•	0.0025	0.0040	0.0050	0.0065	0.0065	0.0070	0.0080	•	•
Cast iron	≤240 Bhn	640	•	0.0080	0.0125	0.0160	0.0200	0.0200	0.0220	0.0245	•	•
	<300 Bhn	525	•	0.0080	0.0125	0.0160	0.0200	0.0200	0.0220	0.0245	•	•
Spheroidal graphite iron and malleable cast iron	≤240 Bhn	435	•	0.0080	0.0125	0.0160	0.0200	0.0200	0.0220	0.0245	•	•
	<300 Bhn	415	•	0.0065	0.0100	0.0125	0.0160	0.0160	0.0180	0.0200	•	•
Chilled cast iron	≤350 Bhn	130	•	0.0020	0.0030	0.0040	0.0050	0.0050	0.0055	0.0065	•	•
Ti and Ti-alloys	≤24 Rc	140	•	0.0020	0.0030	0.0040	0.0050	0.0050	0.0055	0.0065	•	•
	>24-38 Rc	130	•	0.0020	0.0030	0.0040	0.0050	0.0050	0.0055	0.0065	•	•
Aluminium and Al-alloys	≤120 Bhn	1000	•	0.0080	0.0125	0.0160	0.0200	0.0200	0.0220	0.0245	•	•
Al wrought alloys	≤150 Bhn	1000	•	0.0080	0.0125	0.0160	0.0200	0.0200	0.0220	0.0245	•	•
Al cast alloys ≤ 10 % Si	≤200 Bhn	845	•	0.0080	0.0125	0.0160	0.0200	0.0200	0.0220	0.0245	•	•
	> 10 % Si	710	•	0.0080	0.0125	0.0160	0.0200	0.0200	0.0220	0.0245	•	•
Magnesium alloys	≤150 Bhn	900	•	0.0065	0.0100	0.0125	0.0160	0.0160	0.0180	0.0200	•	•
Copper, low-alloyed	≤120 Bhn	400	•	0.0065	0.0100	0.0125	0.0160	0.0160	0.0180	0.0200	•	•
Brass, short-chipping	≤200 Bhn	1050	•	0.0080	0.0125	0.0160	0.0200	0.0200	0.0220	0.0245	•	•
long-chipping	≤200 Bhn	710	•	0.0065	0.0100	0.0125	0.0160	0.0160	0.0180	0.0200	•	•
Bronze, short-chipping	≤200 Bhn	410	•	0.0065	0.0100	0.0125	0.0160	0.0160	0.0180	0.0200	•	•
	>200-260 Bhn	345	•	0.0050	0.0080	0.0100	0.0125	0.0125	0.0140	0.0160	•	•
Bronze, long-chipping	≤24 Rc	285	•	0.0050	0.0080	0.0100	0.0125	0.0125	0.0140	0.0160	•	•
	>24-30 Rc	250	•	0.0050	0.0080	0.0100	0.0125	0.0125	0.0140	0.0160	•	•
Duroplastics	–	–	•	•	•	•	•	•	•	•	•	•
Thermoplastics	–	–	•	•	•	•	•	•	•	•	•	•
Reinforced plastics - Kevlar	–	–	•	•	•	•	•	•	•	•	•	•
Reinforced plastics - GFK / CFK	–	–	•	•	•	•	•	•	•	•	•	•

Series # 5641

Material group	Hardness	SFM	Feed Rate - IPR									
			1/16 in. 1.590 mm	1/8 in. 3.170 mm	1/4 in. 6.350 mm	3/8 in. 9.520 mm	1/2 in. 12.700 mm	5/8 in. 15.870 mm	3/4 in. 19.050 mm	1 in. 25.400 mm	1 1/4 in. 31.750 mm	1 1/2 in. 38.100 mm
Common structural steels	≤100 Bhn	330	0.0002	0.0003	0.0005	0.0009	0.0011	0.0014	•	•	•	•
	>100-260 Bhn	280	0.0002	0.0003	0.0005	0.0009	0.0011	0.0014	•	•	•	•
Free-cutting steels	≤24 Rc	295	0.0002	0.0003	0.0005	0.0009	0.0011	0.0014	•	•	•	•
	>24-30 Rc	265	0.0002	0.0003	0.0005	0.0009	0.0011	0.0014	•	•	•	•
Unalloyed heat-treatable steels	≤16 Rc	295	0.0002	0.0002	0.0004	0.0006	0.0006	0.0010	•	•	•	•
	16-24 Rc	265	0.0002	0.0002	0.0004	0.0006	0.0006	0.0010	•	•	•	•
	24-30 Rc	245	0.0002	0.0002	0.0004	0.0006	0.0006	0.0010	•	•	•	•
Alloyed heat-treatable steels	24-30 Rc	245	0.0002	0.0002	0.0004	0.0006	0.0006	0.0010	•	•	•	•
	>30-38 Rc	215	0.0002	0.0002	0.0004	0.0006	0.0006	0.0010	•	•	•	•
Unalloyed case hardened steels	≤230 Bhn	265	0.0002	0.0003	0.0005	0.0009	0.0011	0.0014	•	•	•	•
Alloyed case hardened steels	24-30 Rc	245	0.0002	0.0002	0.0004	0.0006	0.0006	0.0010	•	•	•	•
	>30-38 Rc	215	0.0002	0.0002	0.0004	0.0006	0.0006	0.0010	•	•	•	•
Nitriding steels	≥24-30 Rc	245	0.0002	0.0002	0.0004	0.0006	0.0006	0.0010	•	•	•	•
	>30-38 Rc	215	0.0002	0.0002	0.0004	0.0006	0.0006	0.0010	•	•	•	•
Tool steels	≤24 Rc	245	0.0001	0.0002	0.0003	0.0004	0.0005	0.0008	•	•	•	•
	>24-30 Rc	215	0.0001	0.0002	0.0003	0.0004	0.0005	0.0008	•	•	•	•
High speed steels	≥14-30 Rc	180	0.0001	0.0002	0.0003	0.0004	0.0005	0.0008	•	•	•	•
Spring steels	≤330 Bhn	215	0.0001	0.0002	0.0003	0.0004	0.0005	0.0008	•	•	•	•
Stainless steels, sulphured	≤24 Rc	180	0.0002	0.0002	0.0004	0.0006	0.0006	0.0010	•	•	•	•
austenitic	≤24 Rc	150	0.0002	0.0002	0.0004	0.0006	0.0006	0.0010	•	•	•	•
martensitic	≤24 Rc	115	0.0002	0.0002	0.0004	0.0006	0.0006	0.0010	•	•	•	•
Hardened steels	≤40-48 Rc	100	0.0001	0.0002	0.0003	0.0004	0.0005	0.0008	•	•	•	•
	>48-60 Rc	85	0.0001	0.0002	0.0003	0.0004	0.0005	0.0008	•	•	•	•
Special alloys	≤38 Rc	115	0.0001	0.0002	0.0003	0.0004	0.0005	0.0008	•	•	•	•
Cast iron	≤240 Bhn	180	0.0003	0.0005	0.0009	0.0013	0.0016	0.0020	•	•	•	•
	<300 Bhn	160	0.0003	0.0005	0.0009	0.0013	0.0016	0.0020	•	•	•	•
Spheroidal graphite iron and malleable cast iron	≤240 Bhn	260	0.0002	0.0003	0.0005	0.0009	0.0011	0.0014	•	•	•	•
	<300 Bhn	230	0.0002	0.0003	0.0005	0.0009	0.0011	0.0014	•	•	•	•
Chilled cast iron	≤350 Bhn	180	0.0002	0.0002	0.0004	0.0006	0.0006	0.0010	•	•	•	•
Ti and Ti-alloys	≤24 Rc	115	0.0001	0.0002	0.0003	0.0004	0.0005	0.0008	•	•	•	•
	>24-38 Rc	100	0.0001	0.0002	0.0003	0.0004	0.0005	0.0008	•	•	•	•
Aluminium and Al-alloys	≤120 Bhn	590	0.0005	0.0007	0.0014	0.0018	0.0022	0.0026	•	•	•	•
Al wrought alloys	≤150 Bhn	655	0.0003	0.0005	0.0009	0.0013	0.0016	0.0020	•	•	•	•
Al cast alloys ≤ 10 % Si	≤200 Bhn	525	0.0005	0.0007	0.0014	0.0018	0.0022	0.0026	•	•	•	•
	> 10 % Si	395	0.0005	0.0007	0.0014	0.0018	0.0022	0.0026	•	•	•	•
Magnesium alloys	≤150 Bhn	245	0.0005	0.0007	0.0014	0.0018	0.0022	0.0026	•	•	•	•
Copper, low-alloyed	≤120 Bhn	395	0.0002	0.0003	0.0005	0.0009	0.0011	0.0014	•	•	•	•
Brass, short-chipping	≤200 Bhn	295	0.0008	0.0012	0.0024	0.0027	0.0030	0.0033	•	•	•	•
long-chipping	≤200 Bhn	215	0.0008	0.0012	0.0024	0.0027	0.0030	0.0033	•	•	•	•
Bronze, short-chipping	≤200 Bhn	245	0.0005	0.0007	0.0014	0.0018	0.0022	0.0026	•	•	•	•
	>200-260 Bhn	–	–	–	–	–	–	–	•	•	•	•
Bronze, long-chipping	≤24 Rc	230	0.0005	0.0007	0.0014	0.0018	0.0022	0.0026	•	•	•	•
	>24-30 Rc	–	–	–	–	–	–	–	•	•	•	•
Duroplastics	–	230	0.0002	0.0003	0.0005	0.0009	0.0011	0.0014	•	•	•	•
Thermoplastics	–	200	0.0002	0.0003	0.0005	0.0009	0.0011	0.0014	•	•	•	•
Reinforced plastics - Kevlar	–	165	0.0002	0.0002	0.0004	0.0006	0.0006	0.0010	•	•	•	•
Reinforced plastics - GFK / CFK	–	–	–	–	–	–	–	–	•	•	•	•

$RPM = \frac{SFM}{DIAM. in.} \times 3.82$ $IPM = IPR \times RPM$

$HOLE DEPTH in. \times 60 = \text{Cut Time}$ IPM $mm = in. \times 25.40$

$m/min. = SFM \div 3.28$ $Bar = PSI \div 14.50$
 $mm/rev. = IPR \times 25.40$ $Liter = Gal. \div 3.79$

Series # 5642

Material group	Hardness	SFM	Feed Rate - IPR									
			1/16 in. 1.590 mm	1/8 in. 3.170 mm	1/4 in. 6.350 mm	3/8 in. 9.520 mm	1/2 in. 12.700 mm	5/8 in. 15.870 mm	3/4 in. 19.050 mm	1 in. 25.400 mm	1 1/4 in. 31.750 mm	1 1/2 in. 38.100 mm
Common structural steels	≤100 Bhn >100-260 Bhn	330 280	0.0002 0.0002	0.0003 0.0003	0.0005 0.0005	0.0009 0.0009	0.0011 0.0011	0.0014 0.0014	•	•	•	•
Free-cutting steels	≤24 Rc >24-30 Rc	295 265	0.0002 0.0002	0.0003 0.0003	0.0005 0.0005	0.0009 0.0009	0.0011 0.0011	0.0014 0.0014	•	•	•	•
Unalloyed heat-treatable steels	≤16 Rc 16-24 Rc 24-30 Rc	295 265 245	0.0002 0.0002 0.0002	0.0002 0.0002 0.0002	0.0004 0.0004 0.0004	0.0006 0.0006 0.0006	0.0006 0.0006 0.0006	0.0010 0.0010 0.0010	•	•	•	•
Alloyed heat-treatable steels	24-30 Rc >30-38 Rc	245 215	0.0002 0.0002	0.0002 0.0002	0.0004 0.0004	0.0006 0.0006	0.0006 0.0006	0.0010 0.0010	•	•	•	•
Unalloyed case hardened steels	≥230 Bhn	265	0.0002	0.0003	0.0005	0.0009	0.0011	0.0014	•	•	•	•
Alloyed case hardened steels	24-30 Rc >30-38 Rc	245 215	0.0002 0.0002	0.0002 0.0002	0.0004 0.0004	0.0006 0.0006	0.0006 0.0006	0.0010 0.0010	•	•	•	•
Nitriding steels	≥24-30 Rc >30-38 Rc	245 215	0.0002 0.0002	0.0002 0.0002	0.0004 0.0004	0.0006 0.0006	0.0006 0.0006	0.0010 0.0010	•	•	•	•
Tool steels	≤24 Rc >24-30 Rc	245 215	0.0001 0.0001	0.0002 0.0002	0.0003 0.0003	0.0004 0.0004	0.0005 0.0005	0.0008 0.0008	•	•	•	•
High speed steels	≥14-30 Rc	180	0.0001	0.0002	0.0003	0.0004	0.0005	0.0008	•	•	•	•
Spring steels	≤330 Bhn	215	0.0001	0.0002	0.0003	0.0004	0.0005	0.0008	•	•	•	•
Stainless steels, sulphured austenitic martensitic	≤24 Rc ≤24 Rc ≤24 Rc	180 150 115	0.0002 0.0002 0.0002	0.0002 0.0002 0.0002	0.0004 0.0004 0.0004	0.0006 0.0006 0.0006	0.0006 0.0006 0.0006	0.0010 0.0010 0.0010	•	•	•	•
Hardened steels	≤40-48 Rc >48-60 Rc	100 85	0.0001 0.0001	0.0002 0.0002	0.0003 0.0003	0.0004 0.0004	0.0005 0.0005	0.0008 0.0008	•	•	•	•
Special alloys	≤38 Rc	115	0.0001	0.0002	0.0003	0.0004	0.0005	0.0008	•	•	•	•
Cast iron	≤240 Bhn <300 Bhn	180 160	0.0003 0.0003	0.0005 0.0005	0.0009 0.0009	0.0013 0.0013	0.0016 0.0016	0.0020 0.0020	•	•	•	•
Spheroidal graphite iron and malleable cast iron	≤240 Bhn <300 Bhn	260 230	0.0002 0.0002	0.0003 0.0003	0.0005 0.0005	0.0009 0.0009	0.0011 0.0011	0.0014 0.0014	•	•	•	•
Chilled cast iron	≤350 Bhn	180	0.0002	0.0002	0.0004	0.0006	0.0006	0.0010	•	•	•	•
Ti and Ti-alloys	≤24 Rc >24-38 Rc	115 100	0.0001 0.0001	0.0002 0.0002	0.0003 0.0003	0.0004 0.0004	0.0005 0.0005	0.0008 0.0008	•	•	•	•
Aluminium and Al-alloys	≤120 Bhn	590	0.0005	0.0007	0.0014	0.0018	0.0022	0.0026	•	•	•	•
Al wrought alloys	≤150 Bhn	655	0.0003	0.0005	0.0009	0.0013	0.0016	0.0020	•	•	•	•
Al cast alloys ≤ 10 % Si > 10 % Si	≤200 Bhn ≤200 Bhn	525 395	0.0005 0.0005	0.0007 0.0007	0.0014 0.0014	0.0018 0.0018	0.0022 0.0022	0.0026 0.0026	•	•	•	•
Magnesium alloys	≤150 Bhn	245	0.0005	0.0007	0.0014	0.0018	0.0022	0.0026	•	•	•	•
Copper, low-alloyed	≤120 Bhn	395	0.0002	0.0003	0.0005	0.0009	0.0011	0.0014	•	•	•	•
Brass, short-chipping long-chipping	≤200 Bhn ≤200 Bhn	295 215	0.0008 0.0008	0.0012 0.0012	0.0024 0.0024	0.0027 0.0027	0.0030 0.0030	0.0033 0.0033	•	•	•	•
Bronze, short-chipping	≤200 Bhn >200-260 Bhn	245	0.0005	0.0007	0.0014	0.0018	0.0022	0.0026	•	•	•	•
Bronze, long-chipping	≤24 Rc >24-30 Rc	230	0.0005	0.0007	0.0014	0.0018	0.0022	0.0026	•	•	•	•
Duroplastics	-	230	0.0002	0.0003	0.0005	0.0009	0.0011	0.0014	•	•	•	•
Thermoplastics	-	200	0.0002	0.0003	0.0005	0.0009	0.0011	0.0014	•	•	•	•
Reinforced plastics - Kevlar	-	165	0.0002	0.0002	0.0004	0.0006	0.0006	0.0010	•	•	•	•
Reinforced plastics - GFK / CFK	-	-	-	-	-	-	-	-	•	•	•	•

Series # 5646

Material group	Hardness	SFM	Feed Rate - IPR									
			1/16 in. 1.590 mm	1/8 in. 3.170 mm	1/4 in. 6.350 mm	3/8 in. 9.520 mm	1/2 in. 12.700 mm	5/8 in. 15.870 mm	3/4 in. 19.050 mm	1 in. 25.400 mm	1 1/4 in. 31.750 mm	1 1/2 in. 38.100 mm
Common structural steels	≤100 Bhn >100-260 Bhn	330 280	0.0003 0.0003	0.0006 0.0006	0.0009 0.0009	0.0015 0.0015	•	•	•	•	•	•
Free-cutting steels	≤24 Rc >24-30 Rc	295 260	0.0003 0.0003	0.0006 0.0006	0.0009 0.0009	0.0015 0.0015	•	•	•	•	•	•
Unalloyed heat-treatable steels	≤16 Rc 16-24 Rc 24-30 Rc	295 260 245	0.0002 0.0002 0.0002	0.0004 0.0004 0.0004	0.0005 0.0005 0.0005	0.0010 0.0010 0.0010	•	•	•	•	•	•
Alloyed heat-treatable steels	24-30 Rc >30-38 Rc	245 215	0.0002 0.0002	0.0004 0.0004	0.0005 0.0005	0.0010 0.0010	•	•	•	•	•	•
Unalloyed case hardened steels	≥230 Bhn	260	0.0003	0.0006	0.0009	0.0015	•	•	•	•	•	•
Alloyed case hardened steels	24-30 Rc >30-38 Rc	245 215	0.0002 0.0002	0.0004 0.0004	0.0005 0.0005	0.0010 0.0010	•	•	•	•	•	•
Nitriding steels	≥24-30 Rc >30-38 Rc	245 215	0.0002 0.0002	0.0004 0.0004	0.0005 0.0005	0.0010 0.0010	•	•	•	•	•	•
Tool steels	≤24 Rc >24-30 Rc	245 215	0.0002 0.0002	0.0003 0.0003	0.0004 0.0004	0.0006 0.0006	•	•	•	•	•	•
High speed steels	≥14-30 Rc	180	0.0001	0.0002	0.0003	0.0004	•	•	•	•	•	•
Spring steels	≤330 Bhn	215	0.0002	0.0003	0.0004	0.0006	•	•	•	•	•	•
Stainless steels, sulphured austenitic martensitic	≤24 Rc ≤24 Rc ≤24 Rc	180 150 115	0.0002 0.0002 0.0002	0.0004 0.0004 0.0004	0.0005 0.0005 0.0005	0.0010 0.0010 0.0010	•	•	•	•	•	•
Hardened steels	≤40-48 Rc >48-60 Rc	100 80	0.0002 0.0001	0.0003 0.0002	0.0004 0.0003	0.0006 0.0004	•	•	•	•	•	•
Special alloys	≤38 Rc	115	0.0001	0.0002	0.0003	0.0004	•	•	•	•	•	•
Cast iron	≤240 Bhn <300 Bhn	280 260	0.0005 0.0005	0.0009 0.0009	0.0014 0.0014	0.0020 0.0020	•	•	•	•	•	•
Spheroidal graphite iron and malleable cast iron	≤240 Bhn <300 Bhn	260 230	0.0003 0.0003	0.0006 0.0006	0.0009 0.0009	0.0015 0.0015	•	•	•	•	•	•
Chilled cast iron	≤350 Bhn	180	0.0002	0.0004	0.0005	0.0010	•	•	•	•	•	•
Ti and Ti-alloys	≤24 Rc >24-38 Rc	115 100	0.0001 0.0001	0.0002 0.0002	0.0003 0.0003	0.0004 0.0004	•	•	•	•	•	•
Aluminium and Al-alloys	≤120 Bhn	490	0.0008	0.0016	0.0024	0.0028	•	•	•	•	•	•
Al wrought alloys	≤150 Bhn	395	0.0008	0.0016	0.0024	0.0028	•	•	•	•	•	•
Al cast alloys ≤ 10 % Si > 10 % Si	≤200 Bhn ≤200 Bhn	490 425	0.0013 0.0013	0.0024 0.0024	0.0033 0.0033	0.0047 0.0047	•	•	•	•	•	•
Magnesium alloys	≤150 Bhn	360	0.0008	0.0016	0.0024	0.0028	•	•	•	•	•	•
Copper, low-alloyed	≤120 Bhn	245	0.0003	0.0006	0.0009	0.0015	•	•	•	•	•	•
Brass, short-chipping long-chipping	≤200 Bhn ≤200 Bhn	395 295	0.0013 0.0013	0.0024 0.0024	0.0033 0.0033	0.0047 0.0047	•	•	•	•	•	•
Bronze, short-chipping	≤200 Bhn >200-260 Bhn	310 310	0.0008 0.0008	0.0016 0.0016	0.0024 0.0024	0.0028 0.0028	•	•	•	•	•	•
Bronze, long-chipping	≤24 Rc >24-30 Rc	230 230	0.0008 0.0008	0.0016 0.0016	0.0024 0.0024	0.0028 0.0028	•	•	•	•	•	•
Duroplastics	-	245	0.0003	0.0006	0.0009	0.0015	•	•	•	•	•	•
Thermoplastics	-	230	0.0003	0.0006	0.0009	0.0015	•	•	•	•	•	•
Reinforced plastics - Kevlar	-	195	0.0002	0.0004	0.0005	0.0010	•	•	•	•	•	•
Reinforced plastics - GFK / CFK	-	165	0.0002	0.0004	0.0005	0.0010	•	•	•	•	•	•

Using These Tables. The Speeds & Feeds listed below are conservative recommendations for initial setup. In actual use, depending on the machining environment and workpiece material, significantly higher speeds and feeds may be achievable. Using the below as a starting point, cutting speed/feed can be gradually adjusted upwards until the optimum settings per application are found.
Questions? Contact us by telephone at (800) 776-6170.

Series # 5647

Material group	Hardness	SFM	Feed Rate - IPR									
			1/16 in. 1.590 mm	1/8 in. 3.170 mm	1/4 in. 6.350 mm	3/8 in. 9.520 mm	1/2 in. 12.700 mm	5/8 in. 15.870 mm	3/4 in. 19.050 mm	1 in. 25.400 mm	1 1/4 in. 31.750 mm	1 1/2 in. 38.100 mm
Common structural steels	≤100 Bhn >100-260 Bhn	310 260	0.00024 0.00024	0.00035 0.00035	0.00051 0.00051	0.00098 0.00098	*	*	*	*	*	*
Free-cutting steels	≤24 Rc >24-30 Rc	280 245	0.00024 0.00024	0.00035 0.00035	0.00051 0.00051	0.00098 0.00098	*	*	*	*	*	*
Unalloyed heat-treatable steels	≤16 Rc 16-24 Rc 24-30 Rc	280 245 230	0.00016 0.00016 0.00016	0.00026 0.00026 0.00026	0.00035 0.00035 0.00035	0.00059 0.00059 0.00059	*	*	*	*	*	*
Alloyed heat-treatable steels	24-30 Rc >30-38 Rc	230 195	0.00016 0.00016	0.00026 0.00026	0.00035 0.00035	0.00059 0.00059	*	*	*	*	*	*
Unalloyed case hardened steels	≤230 Bhn	245	0.00024	0.00035	0.00051	0.00098	*	*	*	*	*	*
Alloyed case hardened steels	24-30 Rc >30-38 Rc	230 195	0.00016 0.00016	0.00026 0.00026	0.00035 0.00035	0.00059 0.00059	*	*	*	*	*	*
Nitriding steels	≥24-30 Rc >30-38 Rc	230 195	0.00016 0.00016	0.00026 0.00026	0.00035 0.00035	0.00059 0.00059	*	*	*	*	*	*
Tool steels	≤24 Rc >24-30 Rc	230 195	0.00008 0.00008	0.00018 0.00018	0.00028 0.00028	0.00043 0.00043	*	*	*	*	*	*
High speed steels	≥14-30 Rc	165	0.00008	0.00018	0.00028	0.00043	*	*	*	*	*	*
Spring steels	≤330 Bhn	195	0.00016	0.00026	0.00035	0.00059	*	*	*	*	*	*
Stainless steels, sulphured	≤24 Rc	165	0.00016	0.00026	0.00035	0.00059	*	*	*	*	*	*
Stainless steels, austenitic	≤24 Rc	130	0.00016	0.00026	0.00035	0.00059	*	*	*	*	*	*
Stainless steels, martensitic	≤24 Rc	115	0.00016	0.00026	0.00035	0.00059	*	*	*	*	*	*
Hardened steels	≤40-48 Rc >48-60 Rc	80 65	0.00008 0.00008	0.00018 0.00018	0.00028 0.00028	0.00043 0.00043	*	*	*	*	*	*
Special alloys	≤38 Rc	100	0.00008	0.00018	0.00028	0.00043	*	*	*	*	*	*
Cast iron	≤240 Bhn <300 Bhn	260 245	0.00031 0.00031	0.00055 0.00055	0.00094 0.00094	0.00150 0.00150	*	*	*	*	*	*
Spheroidal graphite iron and malleable cast iron	≤240 Bhn <300 Bhn	245 215	0.00024 0.00024	0.00035 0.00035	0.00051 0.00051	0.00098 0.00098	*	*	*	*	*	*
Chilled cast iron	≤350 Bhn	165	0.00016	0.00026	0.00035	0.00059	*	*	*	*	*	*
Ti and Ti-alloys	≤24 Rc >24-38 Rc	100 80	0.00008 0.00008	0.00018 0.00018	0.00028 0.00028	0.00043 0.00043	*	*	*	*	*	*
Aluminium and Al-alloys	≤120 Bhn	460	0.00031	0.00055	0.00094	0.00150	*	*	*	*	*	*
Al wrought alloys	≤150 Bhn	375	0.00031	0.00055	0.00094	0.00150	*	*	*	*	*	*
Al cast alloys ≤ 10 % Si	≤200 Bhn	460	0.00079	0.00157	0.00240	0.00276	*	*	*	*	*	*
Al cast alloys > 10 % Si	≤200 Bhn	395	0.00079	0.00157	0.00240	0.00276	*	*	*	*	*	*
Magnesium alloys	≤150 Bhn	0	0.00047	0.00087	0.00138	0.00197	*	*	*	*	*	*
Copper, low-alloyed	≤120 Bhn	230	0.00024	0.00035	0.00051	0.00098	*	*	*	*	*	*
Brass, short-chipping	≤200 Bhn	375	0.00079	0.00157	0.00240	0.00276	*	*	*	*	*	*
Brass, long-chipping	≤200 Bhn	280	0.00079	0.00157	0.00240	0.00276	*	*	*	*	*	*
Bronze, short-chipping	≤200 Bhn >200-260 Bhn	295 295	0.00047 0.00047	0.00087 0.00087	0.00138 0.00138	0.00197 0.00197	*	*	*	*	*	*
Bronze, long-chipping	≤24 Rc >24-30 Rc	215 215	0.00047 0.00024	0.00087 0.00035	0.00138 0.00051	0.00197 0.00098	*	*	*	*	*	*
Duroplastics	-	230	0.00024	0.00035	0.00051	0.00098	*	*	*	*	*	*
Thermoplastics	-	215	0.00024	0.00035	0.00051	0.00098	*	*	*	*	*	*
Reinforced plastics - Kevlar	-	180	0.00016	0.00026	0.00035	0.00059	*	*	*	*	*	*
Reinforced plastics - GFK / CFK	-	150	0.00016	0.00026	0.00035	0.00059	*	*	*	*	*	*

Series # 5648

Material group	Hardness	SFM	Feed Rate - IPR									
			1/16 in. 1.590 mm	1/8 in. 3.170 mm	1/4 in. 6.350 mm	3/8 in. 9.520 mm	1/2 in. 12.700 mm	5/8 in. 15.870 mm	3/4 in. 19.050 mm	1 in. 25.400 mm	1 1/4 in. 31.750 mm	1 1/2 in. 38.100 mm
Common structural steels	≤100 Bhn >100-260 Bhn	310 260	0.00024 0.00024	0.00035 0.00035	0.00051 0.00051	0.00098 0.00098	*	*	*	*	*	*
Free-cutting steels	≤24 Rc >24-30 Rc	280 245	0.00024 0.00024	0.00035 0.00035	0.00051 0.00051	0.00098 0.00098	*	*	*	*	*	*
Unalloyed heat-treatable steels	≤16 Rc 16-24 Rc 24-30 Rc	280 245 230	0.00016 0.00016 0.00016	0.00026 0.00026 0.00026	0.00035 0.00035 0.00035	0.00059 0.00059 0.00059	*	*	*	*	*	*
Alloyed heat-treatable steels	24-30 Rc >30-38 Rc	230 195	0.00016 0.00016	0.00026 0.00026	0.00035 0.00035	0.00059 0.00059	*	*	*	*	*	*
Unalloyed case hardened steels	≤230 Bhn	245	0.00024	0.00035	0.00051	0.00098	*	*	*	*	*	*
Alloyed case hardened steels	24-30 Rc >30-38 Rc	230 195	0.00016 0.00016	0.00026 0.00026	0.00035 0.00035	0.00059 0.00059	*	*	*	*	*	*
Nitriding steels	≥24-30 Rc >30-38 Rc	230 195	0.00016 0.00016	0.00026 0.00026	0.00035 0.00035	0.00059 0.00059	*	*	*	*	*	*
Tool steels	≤24 Rc >24-30 Rc	230 195	0.00008 0.00008	0.00018 0.00018	0.00028 0.00028	0.00043 0.00043	*	*	*	*	*	*
High speed steels	≥14-30 Rc	165	0.00008	0.00018	0.00028	0.00043	*	*	*	*	*	*
Spring steels	≤330 Bhn	195	0.00016	0.00026	0.00035	0.00059	*	*	*	*	*	*
Stainless steels, sulphured	≤24 Rc	165	0.00016	0.00026	0.00035	0.00059	*	*	*	*	*	*
Stainless steels, austenitic	≤24 Rc	130	0.00016	0.00026	0.00035	0.00059	*	*	*	*	*	*
Stainless steels, martensitic	≤24 Rc	115	0.00016	0.00026	0.00035	0.00059	*	*	*	*	*	*
Hardened steels	≤40-48 Rc >48-60 Rc	80 65	0.00008 0.00008	0.00018 0.00018	0.00028 0.00028	0.00043 0.00043	*	*	*	*	*	*
Special alloys	≤38 Rc	100	0.00008	0.00018	0.00028	0.00043	*	*	*	*	*	*
Cast iron	≤240 Bhn <300 Bhn	260 245	0.00031 0.00031	0.00055 0.00055	0.00094 0.00094	0.00150 0.00150	*	*	*	*	*	*
Spheroidal graphite iron and malleable cast iron	≤240 Bhn <300 Bhn	245 215	0.00024 0.00024	0.00035 0.00035	0.00051 0.00051	0.00098 0.00098	*	*	*	*	*	*
Chilled cast iron	≤350 Bhn	165	0.00016	0.00026	0.00035	0.00059	*	*	*	*	*	*
Ti and Ti-alloys	≤24 Rc >24-38 Rc	100 80	0.00008 0.00008	0.00018 0.00018	0.00028 0.00028	0.00043 0.00043	*	*	*	*	*	*
Aluminium and Al-alloys	≤120 Bhn	460	0.00031	0.00055	0.00094	0.00150	*	*	*	*	*	*
Al wrought alloys	≤150 Bhn	375	0.00031	0.00055	0.00094	0.00150	*	*	*	*	*	*
Al cast alloys ≤ 10 % Si	≤200 Bhn	460	0.00079	0.00157	0.00240	0.00276	*	*	*	*	*	*
Al cast alloys > 10 % Si	≤200 Bhn	395	0.00079	0.00157	0.00240	0.00276	*	*	*	*	*	*
Magnesium alloys	≤150 Bhn	0	0.00047	0.00087	0.00138	0.00197	*	*	*	*	*	*
Copper, low-alloyed	≤120 Bhn	230	0.00024	0.00035	0.00051	0.00098	*	*	*	*	*	*
Brass, short-chipping	≤200 Bhn	375	0.00079	0.00157	0.00240	0.00276	*	*	*	*	*	*
Brass, long-chipping	≤200 Bhn	280	0.00079	0.00157	0.00240	0.00276	*	*	*	*	*	*
Bronze, short-chipping	≤200 Bhn >200-260 Bhn	295 295	0.00047 0.00047	0.00087 0.00087	0.00138 0.00138	0.00197 0.00197	*	*	*	*	*	*
Bronze, long-chipping	≤24 Rc >24-30 Rc	215 215	0.00047 0.00024	0.00087 0.00035	0.00138 0.00051	0.00197 0.00098	*	*	*	*	*	*
Duroplastics	-	230	0.00024	0.00035	0.00051	0.00098	*	*	*	*	*	*
Thermoplastics	-	215	0.00024	0.00035	0.00051	0.00098	*	*	*	*	*	*
Reinforced plastics - Kevlar	-	180	0.00016	0.00026	0.00035	0.00059	*	*	*	*	*	*
Reinforced plastics - GFK / CFK	-	150	0.00016	0.00026	0.00035	0.00059	*	*	*	*	*	*

RPM = $\frac{SFM}{DIAM. in.} \times 3.82$ IPM = IPR x RPM

HOLE DEPTH $\frac{in.}{IPM} \times 60 = \text{Cut Time}$ mm = in. x 25.40

m/min. = SFM \div 3.28 Bar = PSI \div 14.50
mm/rev. = IPR \div 25.40 Liter = Gal. \div 3.79

Series # 5741

Material group	Hardness	SFM	Feed Rate- IPR									
			1/16 in. 1.590 mm	1/8 in. 3.170 mm	1/4 in. 6.350 mm	3/8 in. 9.520 mm	1/2 in. 12.700 mm	5/8 in. 15.870 mm	3/4 in. 19.050 mm	1 in. 25.400 mm	1 1/4 in. 31.750 mm	1 1/2 in. 38.100 mm
Common structural steels	≤100 Bhn	425	*	0.0065	0.0100	0.0125	0.0160	*	*	*	*	*
	>100-260 Bhn	360	*	0.0050	0.0080	0.0100	0.0125	*	*	*	*	*
Free-cutting steels	≤24 Rc	475	*	0.0080	0.0125	0.0160	0.0200	*	*	*	*	*
	>24-30 Rc	360	*	0.0065	0.0100	0.0125	0.0160	*	*	*	*	*
Unalloyed heat-treatable steels	≤16 Rc	395	*	0.0065	0.0100	0.0125	0.0160	*	*	*	*	*
	16-24 Rc	360	*	0.0065	0.0100	0.0125	0.0160	*	*	*	*	*
	24-30 Rc	345	*	0.0065	0.0100	0.0125	0.0160	*	*	*	*	*
Alloyed heat-treatable steels	24-30 Rc	345	*	0.0065	0.0100	0.0125	0.0160	*	*	*	*	*
	>30-38 Rc	330	*	0.0050	0.0080	0.0100	0.0125	*	*	*	*	*
Unalloyed case hardened steels	≤230 Bhn	425	*	0.0080	0.0125	0.0160	0.0200	*	*	*	*	*
Alloyed case hardened steels	24-30 Rc	395	*	0.0065	0.0100	0.0125	0.0160	*	*	*	*	*
	>30-38 Rc	280	*	0.0040	0.0065	0.0080	0.0100	*	*	*	*	*
Nitriding steels	≥24-30 Rc	330	*	0.0050	0.0080	0.0100	0.0125	*	*	*	*	*
	>30-38 Rc	295	*	0.0040	0.0065	0.0080	0.0100	*	*	*	*	*
Tool steels	≤24 Rc	215	*	0.0050	0.0080	0.0100	0.0125	*	*	*	*	*
	>24-30 Rc	180	*	0.0040	0.0065	0.0080	0.0100	*	*	*	*	*
High speed steels	≥14-30 Rc	150	*	0.0030	0.0050	0.0065	0.0080	*	*	*	*	*
Spring steels	≤330 Bhn	150	*	0.0025	0.0040	0.0050	0.0065	*	*	*	*	*
Stainless steels, sulphured austenitic martensitic	≤24 Rc	180	*	0.0030	0.0050	0.0065	0.0080	*	*	*	*	*
	≤24 Rc	150	*	0.0030	0.0050	0.0065	0.0080	*	*	*	*	*
	≤24 Rc	150	*	0.0025	0.0040	0.0050	0.0065	*	*	*	*	*
Hardened steels	≤40-48 Rc	150	*	0.0025	0.0040	0.0050	0.0065	*	*	*	*	*
	>48-60 Rc	80	*	0.0020	0.0030	0.0040	0.0050	*	*	*	*	*
Special alloys	≤38 Rc	80	*	0.0030	0.0050	0.0065	0.0080	*	*	*	*	*
Cast iron	≤240 Bhn	690	*	0.0080	0.0125	0.0160	0.0200	*	*	*	*	*
	<300 Bhn	510	*	0.0080	0.0125	0.0160	0.0200	*	*	*	*	*
Spheroidal graphite iron and malleable cast iron	≤240 Bhn	510	*	0.0065	0.0100	0.0125	0.0160	*	*	*	*	*
	<300 Bhn	410	*	0.0065	0.0100	0.0125	0.0160	*	*	*	*	*
Chilled cast iron	≤350 Bhn	115	*	0.0025	0.0040	0.0050	0.0065	*	*	*	*	*
Ti and Ti-alloys	≤24 Rc	130	*	0.0030	0.0050	0.0065	0.0080	*	*	*	*	*
	>24-38 Rc	115	*	0.0025	0.0040	0.0050	0.0065	*	*	*	*	*
Aluminium and Al-alloys	≤120 Bhn	855	*	0.0100	0.0160	0.0200	0.0245	*	*	*	*	*
Al wrought alloys	≤150 Bhn	855	*	0.0100	0.0160	0.0200	0.0245	*	*	*	*	*
Al cast alloys ≤ 10 % Si > 10 % Si	≤200 Bhn	720	*	0.0080	0.0125	0.0160	0.0200	*	*	*	*	*
	≤200 Bhn	590	*	0.0080	0.0125	0.0160	0.0200	*	*	*	*	*
Magnesium alloys	≤150 Bhn	855	*	0.0080	0.0125	0.0160	0.0200	*	*	*	*	*
Copper, low-alloyed	≤120 Bhn	360	*	0.0065	0.0065	0.0100	0.0125	*	*	*	*	*
Brass, short-chipping long-chipping	≤200 Bhn	885	*	0.0080	0.0125	0.0160	0.0200	*	*	*	*	*
	≤200 Bhn	590	*	0.0065	0.0100	0.0125	0.0160	*	*	*	*	*
Bronze, short-chipping	≤200 Bhn	360	*	0.0065	0.0065	0.0100	0.0125	*	*	*	*	*
	>200-260 Bhn	330	*	0.0050	0.0050	0.0080	0.0100	*	*	*	*	*
Bronze, long-chipping	≤24 Rc	240	*	0.0050	0.0050	0.0080	0.0100	*	*	*	*	*
	>24-30 Rc	215	*	0.0050	0.0050	0.0080	0.0100	*	*	*	*	*
Duroplastics	-	*	*	*	*	*	*	*	*	*	*	*
Thermoplastics	-	*	*	*	*	*	*	*	*	*	*	*
Reinforced plastics - Kevlar	-	*	*	*	*	*	*	*	*	*	*	*
Reinforced plastics - GFK / CFK	-	*	*	*	*	*	*	*	*	*	*	*

Series # 5744

Material group	Hardness	SFM	Feed Rate- IPR									
			1/16 in. 1.590 mm	1/8 in. 3.170 mm	1/4 in. 6.350 mm	3/8 in. 9.520 mm	1/2 in. 12.700 mm	5/8 in. 15.870 mm	3/4 in. 19.050 mm	1 in. 25.400 mm	1 1/4 in. 31.750 mm	1 1/2 in. 38.100 mm
Common structural steels	≤100 Bhn	475	*	0.0065	0.0100	0.0125	0.0160	*	*	*	*	*
	>100-260 Bhn	395	*	0.0050	0.0080	0.0100	0.0125	*	*	*	*	*
Free-cutting steels	≤24 Rc	560	*	0.0080	0.0125	0.0160	0.0200	*	*	*	*	*
	>24-30 Rc	475	*	0.0080	0.0125	0.0160	0.0200	*	*	*	*	*
Unalloyed heat-treatable steels	≤16 Rc	425	*	0.0080	0.0125	0.0160	0.0200	*	*	*	*	*
	16-24 Rc	410	*	0.0065	0.0100	0.0125	0.0160	*	*	*	*	*
	24-30 Rc	395	*	0.0065	0.0100	0.0125	0.0160	*	*	*	*	*
Alloyed heat-treatable steels	24-30 Rc	395	*	0.0065	0.0100	0.0125	0.0160	*	*	*	*	*
	>30-38 Rc	345	*	0.0065	0.0100	0.0125	0.0160	*	*	*	*	*
Unalloyed case hardened steels	≤230 Bhn	475	*	0.0080	0.0125	0.0160	0.0200	*	*	*	*	*
Alloyed case hardened steels	24-30 Rc	395	*	0.0065	0.0100	0.0125	0.0160	*	*	*	*	*
	>30-38 Rc	280	*	0.0040	0.0065	0.0080	0.0100	*	*	*	*	*
Nitriding steels	≥24-30 Rc	350	*	0.0065	0.0100	0.0125	0.0160	*	*	*	*	*
	>30-38 Rc	330	*	0.0040	0.0065	0.0080	0.0100	*	*	*	*	*
Tool steels	≤24 Rc	240	*	0.0050	0.0080	0.0100	0.0125	*	*	*	*	*
	>24-30 Rc	180	*	0.0040	0.0065	0.0080	0.0100	*	*	*	*	*
High speed steels	≥14-30 Rc	195	*	0.0030	0.0050	0.0065	0.0080	*	*	*	*	*
Spring steels	≤330 Bhn	195	*	0.0025	0.0040	0.0050	0.0065	*	*	*	*	*
Stainless steels, sulphured austenitic martensitic	≤24 Rc	195	*	0.0040	0.0065	0.0080	0.0100	*	*	*	*	*
	≤24 Rc	180	*	0.0040	0.0065	0.0080	0.0100	*	*	*	*	*
	≤24 Rc	165	*	0.0040	0.0065	0.0080	0.0100	*	*	*	*	*
Hardened steels	≤40-48 Rc	180	*	0.0025	0.0040	0.0050	0.0065	*	*	*	*	*
	>48-60 Rc	115	*	0.0020	0.0030	0.0040	0.0050	*	*	*	*	*
Special alloys	≤38 Rc	115	*	0.0030	0.0050	0.0065	0.0080	*	*	*	*	*
Cast iron	≤240 Bhn	690	*	0.0100	0.0160	0.0200	0.0245	*	*	*	*	*
	<300 Bhn	525	*	0.0100	0.0160	0.0200	0.0245	*	*	*	*	*
Spheroidal graphite iron and malleable cast iron	≤240 Bhn	450	*	0.0100	0.0160	0.0200	0.0245	*	*	*	*	*
	<300 Bhn	425	*	0.0080	0.0125	0.0160	0.0200	*	*	*	*	*
Chilled cast iron	≤350 Bhn	130	*	0.0025	0.0040	0.0050	0.0065	*	*	*	*	*
Ti and Ti-alloys	≤24 Rc	150	*	0.0030	0.0050	0.0065	0.0080	*	*	*	*	*
	>24-38 Rc	130	*	0.0025	0.0040	0.0050	0.0065	*	*	*	*	*
Aluminium and Al-alloys	≤120 Bhn	1015	*	0.0080	0.0125	0.0160	0.0200	*	*	*	*	*
Al wrought alloys	≤150 Bhn	1015	*	0.0080	0.0125	0.0160	0.0200	*	*	*	*	*
Al cast alloys ≤ 10 % Si > 10 % Si	≤200 Bhn	855	*	0.0080	0.0125	0.0160	0.0200	*	*	*	*	*
	≤200 Bhn	720	*	0.0080	0.0125	0.0160	0.0200	*	*	*	*	*
Magnesium alloys	≤150 Bhn	920	*	0.0080	0.0125	0.0160	0.0200	*	*	*	*	*
Copper, low-alloyed	≤120 Bhn	410	*	0.0065	0.0100	0.0125	0.0160	*	*	*	*	*
Brass, short-chipping long-chipping	≤200 Bhn	1065	*	0.0080	0.0125	0.0160	0.0200	*	*	*	*	*
	≤200 Bhn	720	*	0.0065	0.0100	0.0125	0.0160	*	*	*	*	*
Bronze, short-chipping	≤200 Bhn	410	*	0.0065	0.0100	0.0125	0.0160	*	*	*	*	*
	>200-260 Bhn	345	*	0.0050	0.0080	0.0100	0.0125	*	*	*	*	*
Bronze, long-chipping	≤24 Rc	295	*	0.0050	0.0080	0.0100	0.0125	*	*	*	*	*
	>24-30 Rc	260	*	0.0050	0.0080	0.0100	0.0125	*	*	*	*	*
Duroplastics	-	*	*	*	*	*	*	*	*	*	*	*
Thermoplastics	-	*	*	*	*	*	*	*	*	*	*	*
Reinforced plastics - Kevlar	-	*	*	*	*	*	*	*	*	*	*	*
Reinforced plastics - GFK / CFK	-	*	*	*	*	*	*	*	*	*	*	*

Using These Tables. The Speeds & Feeds listed below are conservative recommendations for initial setup. In actual use, depending on the machining environment and workpiece material, significantly higher speeds and feeds may be achievable. Using the below as a starting point, cutting speed/feed can be gradually adjusted upwards until the optimum settings per application are found. Questions? Contact us by telephone at (800) 776-6170.

Series # 5746

Material group	Hardness	SFM	Feed Rate - IPR										
			1/16 in. 1.590 mm	1/8 in. 3.170 mm	1/4 in. 6.350 mm	3/8 in. 9.520 mm	1/2 in. 12.700 mm	5/8 in. 15.870 mm	3/4 in. 19.050 mm	1 in. 25.400 mm	1 1/4 in. 31.750 mm	1 1/2 in. 38.100 mm	
Common structural steels	≤100 Bhn >100-260 Bhn	460 395	•	0.0050	0.0080	0.0100	0.0125	•	•	•	•	•	•
Free-cutting steels	≤24 Rc >24-30 Rc	550 480	•	0.0065	0.0100	0.0125	0.0160	•	•	•	•	•	•
Unalloyed heat-treatable steels	≤16 Rc 16-24 Rc 24-30 Rc	415 400 395	•	0.0065	0.0100	0.0125	0.0160	•	•	•	•	•	•
Alloyed heat-treatable steels	24-30 Rc >30-38 Rc	395 335	•	0.0050	0.0080	0.0100	0.0125	•	•	•	•	•	•
Unalloyed case hardened steels	≤230 Bhn	465	•	0.0065	0.0100	0.0125	0.0160	•	•	•	•	•	•
Alloyed case hardened steels	24-30 Rc >30-38 Rc	395 270	•	0.0050	0.0080	0.0100	0.0125	•	•	•	•	•	•
Nitriding steels	≥24-30 Rc >30-38 Rc	340 325	•	0.0050	0.0080	0.0100	0.0125	•	•	•	•	•	•
Tool steels	≤24 Rc >24-30 Rc	230 175	•	0.0040	0.0065	0.0080	0.0100	•	•	•	•	•	•
High speed steels	≥14-30 Rc	195	•	0.0025	0.0040	0.0050	0.0065	•	•	•	•	•	•
Spring steels	≤330 Bhn	195	•	0.0020	0.0030	0.0040	0.0050	•	•	•	•	•	•
Stainless steels, sulphured austenitic martensitic	≤24 Rc ≤24 Rc ≤24 Rc	195 175 155	•	0.0030	0.0050	0.0065	0.0080	•	•	•	•	•	•
Hardened steels	≤40-48 Rc >48-60 Rc	175 110	•	0.0020	0.0030	0.0040	0.0050	•	•	•	•	•	•
Special alloys	≤38 Rc	110	•	0.0025	0.0040	0.0050	0.0065	•	•	•	•	•	•
Cast iron	≤240 Bhn <300 Bhn	640 525	•	0.0080	0.0125	0.0160	0.0200	•	•	•	•	•	•
Spheroidal graphite iron and malleable cast iron	≤240 Bhn <300 Bhn	435 415	•	0.0080	0.0100	0.0125	0.0160	•	•	•	•	•	•
Chilled cast iron	≤350 Bhn	130	•	0.0020	0.0030	0.0040	0.0050	•	•	•	•	•	•
Ti and Ti-alloys	≤24 Rc >24-38 Rc	140 130	•	0.0020	0.0030	0.0040	0.0050	•	•	•	•	•	•
Aluminium and Al-alloys	≤120 Bhn	1000	•	0.0080	0.0125	0.0160	0.0200	•	•	•	•	•	•
Al wrought alloys	≤150 Bhn	1000	•	0.0080	0.0125	0.0160	0.0200	•	•	•	•	•	•
Al cast alloys ≤ 10 % Si > 10 % Si	≤200 Bhn ≤200 Bhn	845 710	•	0.0080	0.0125	0.0160	0.0200	•	•	•	•	•	•
Magnesium alloys	≤150 Bhn	900	•	0.0065	0.0100	0.0125	0.0160	•	•	•	•	•	•
Copper, low-alloyed	≤120 Bhn	400	•	0.0065	0.0100	0.0125	0.0160	•	•	•	•	•	•
Brass, short-chipping long-chipping	≤200 Bhn ≤200 Bhn	1050 710	•	0.0080	0.0100	0.0125	0.0160	•	•	•	•	•	•
Bronze, short-chipping	≤200 Bhn >200-260 Bhn	410 345	•	0.0065	0.0100	0.0125	0.0160	•	•	•	•	•	•
Bronze, long-chipping	≤24 Rc >24-30 Rc	285 250	•	0.0050	0.0080	0.0100	0.0125	•	•	•	•	•	•
Duroplastics	-	-	•	•	•	•	•	•	•	•	•	•	•
Thermoplastics	-	-	•	•	•	•	•	•	•	•	•	•	•
Reinforced plastics - Kevlar	-	-	•	•	•	•	•	•	•	•	•	•	•
Reinforced plastics - GFK / CFK	-	-	•	•	•	•	•	•	•	•	•	•	•

Series # 6068

Material group	Hardness	SFM	Feed Rate - IPR										
			1/16 in. 1.590 mm	1/8 in. 3.170 mm	1/4 in. 6.350 mm	3/8 in. 9.520 mm	1/2 in. 12.700 mm	5/8 in. 15.870 mm	3/4 in. 19.050 mm	1 in. 25.400 mm	1 1/4 in. 31.750 mm	1 1/2 in. 38.100 mm	
Common structural steels	≤100 Bhn >100-260 Bhn	•	•	•	•	•	•	•	•	•	•	•	•
Free-cutting steels	≤24 Rc >24-30 Rc	•	•	•	•	•	•	•	•	•	•	•	•
Unalloyed heat-treatable steels	≤16 Rc 16-24 Rc 24-30 Rc	•	•	•	•	•	•	•	•	•	•	•	•
Alloyed heat-treatable steels	24-30 Rc >30-38 Rc	•	•	•	•	•	•	•	•	•	•	•	•
Unalloyed case hardened steels	≤230 Bhn	•	•	•	•	•	•	•	•	•	•	•	•
Alloyed case hardened steels	24-30 Rc >30-38 Rc	•	•	•	•	•	•	•	•	•	•	•	•
Nitriding steels	≥24-30 Rc >30-38 Rc	•	•	•	•	•	•	•	•	•	•	•	•
Tool steels	≤24 Rc >24-30 Rc	•	•	•	•	•	•	•	•	•	•	•	•
High speed steels	≥14-30 Rc	•	•	•	•	•	•	•	•	•	•	•	•
Spring steels	≤330 Bhn	•	•	•	•	•	•	•	•	•	•	•	•
Stainless steels, sulphured austenitic martensitic	≤24 Rc ≤24 Rc ≤24 Rc	•	•	•	•	•	•	•	•	•	•	•	•
Hardened steels	≤40-48 Rc >48-60 Rc	•	•	•	•	•	•	•	•	•	•	•	•
Special alloys	≤38 Rc	•	•	•	•	•	•	•	•	•	•	•	•
Cast iron	≤240 Bhn <300 Bhn	395 330	•	0.0050	0.0080	0.0120	0.0125	0.0160	0.0200	•	•	•	•
Spheroidal graphite iron and malleable cast iron	≤240 Bhn <300 Bhn	295 260	•	0.0050	0.0080	0.0120	0.0125	0.0160	0.0200	•	•	•	•
Chilled cast iron	≤350 Bhn	130	•	0.0016	0.0025	0.0035	0.0040	0.0050	0.0060	•	•	•	•
Ti and Ti-alloys	≤24 Rc >24-38 Rc	•	•	•	•	•	•	•	•	•	•	•	•
Aluminium and Al-alloys	≤120 Bhn	1345	•	0.0050	0.0080	0.0125	0.0125	0.0160	0.0200	•	•	•	•
Al wrought alloys	≤150 Bhn	1345	•	0.0050	0.0080	0.0125	0.0125	0.0160	0.0200	•	•	•	•
Al cast alloys ≤ 10 % Si > 10 % Si	≤200 Bhn ≤200 Bhn	1245 1080	•	0.0050	0.0080	0.0125	0.0125	0.0160	0.0200	•	•	•	•
Magnesium alloys	≤150 Bhn	•	•	•	•	•	•	•	•	•	•	•	•
Copper, low-alloyed	≤120 Bhn	•	•	•	•	•	•	•	•	•	•	•	•
Brass, short-chipping long-chipping	≤200 Bhn ≤200 Bhn	920	•	0.0060	0.0125	0.0160	0.0200	0.0250	0.0250	•	•	•	•
Bronze, short-chipping	≤200 Bhn >200-260 Bhn	360 260	•	0.0040	0.0060	0.0100	0.0100	0.0120	0.0160	•	•	•	•
Bronze, long-chipping	≤24 Rc >24-30 Rc	•	•	•	•	•	•	•	•	•	•	•	•
Duroplastics	-	-	•	•	•	•	•	•	•	•	•	•	•
Thermoplastics	-	-	•	•	•	•	•	•	•	•	•	•	•
Reinforced plastics - Kevlar	-	-	•	•	•	•	•	•	•	•	•	•	•
Reinforced plastics - GFK / CFK	-	-	•	•	•	•	•	•	•	•	•	•	•

$$RPM = \frac{SFM}{DIAM. \text{ in.}} \times 3.82 \quad IPM = IPR \times RPM$$

$$\frac{HOLE \ DEPTH \ \text{in.}}{IPM} \times 60 = \text{Cut Time} \quad mm = \text{in.} \times 25.40$$

$$m/min. = SFM \div 3.28 \quad \text{Bar} = PSI \div 14.50$$

$$mm/rev. = IPR \times 25.40 \quad \text{Liter} = Gal. \div 3.79$$

Series # 6069

Material group	Hardness	SFM	Feed Rate - IPR										
			1/16 in. 1.590 mm	1/8 in. 3.170 mm	1/4 in. 6.350 mm	3/8 in. 9.520 mm	1/2 in. 12.700 mm	5/8 in. 15.870 mm	3/4 in. 19.050 mm	1 in. 25.400 mm	1 1/4 in. 31.750 mm	1 1/2 in. 38.100 mm	
Common structural steels	≤100 Bhn >100-260 Bhn	•	•	•	•	•	•	•	•	•	•	•	•
Free-cutting steels	≤24 Rc >24-30 Rc	•	•	•	•	•	•	•	•	•	•	•	•
Unalloyed heat-treatable steels	≤16 Rc 16-24 Rc 24-30 Rc	•	•	•	•	•	•	•	•	•	•	•	•
Alloyed heat-treatable steels	24-30 Rc >30-38 Rc	•	•	•	•	•	•	•	•	•	•	•	•
Unalloyed case hardened steels	≤230 Bhn	•	•	•	•	•	•	•	•	•	•	•	•
Alloyed case hardened steels	24-30 Rc >30-38 Rc	•	•	•	•	•	•	•	•	•	•	•	•
Nitriding steels	≥24-30 Rc >30-38 Rc	•	•	•	•	•	•	•	•	•	•	•	•
Tool steels	≤24 Rc >24-30 Rc	•	•	•	•	•	•	•	•	•	•	•	•
High speed steels	≥14-30 Rc	•	•	•	•	•	•	•	•	•	•	•	•
Spring steels	≤330 Bhn	•	•	•	•	•	•	•	•	•	•	•	•
Stainless steels, sulphured austenitic martensitic	≤24 Rc • ≤24 Rc • ≤24 Rc •	•	•	•	•	•	•	•	•	•	•	•	•
Hardened steels	≤40-48 Rc >48-60 Rc	•	•	•	•	•	•	•	•	•	•	•	•
Special alloys	• ≤38 Rc •	•	•	•	•	•	•	•	•	•	•	•	•
Cast iron	≤240 Bhn 395 • ≤300 Bhn 330 •	395 330	•	0.0050 0.0050	0.0080 0.0080	0.0120 0.0120	0.0125 0.0125	0.0160 0.0160	0.0200 0.0200	•	•	•	•
Spheroidal graphite iron and malleable cast iron	≤240 Bhn 295 • ≤300 Bhn 260 •	295 260	•	0.0050 0.0050	0.0080 0.0080	0.0120 0.0120	0.0125 0.0125	0.0160 0.0160	0.0200 0.0200	•	•	•	•
Chilled cast iron	≤350 Bhn	130	•	0.0016	0.0025	0.0035	0.0040	0.0050	0.0060	•	•	•	•
Ti and Ti-alloys	• ≤24 Rc • >24-38 Rc •	•	•	•	•	•	•	•	•	•	•	•	•
Aluminium and Al-alloys	• ≤120 Bhn 1345 • ≤150 Bhn 1345 •	1345 1345	•	0.0050 0.0050	0.0080 0.0080	0.0120 0.0120	0.0125 0.0125	0.0160 0.0160	0.0200 0.0200	•	•	•	•
Al wrought alloys	• ≤150 Bhn 1345 •	1345	•	0.0050	0.0080	0.0120	0.0125	0.0160	0.0200	•	•	•	•
Al cast alloys ≤ 10 % Si	• ≤200 Bhn 1245 • ≤200 Bhn 1080 •	1245 1080	•	0.0050 0.0050	0.0080 0.0080	0.0120 0.0120	0.0125 0.0125	0.0160 0.0160	0.0200 0.0200	•	•	•	•
Al cast alloys > 10 % Si	•	•	•	•	•	•	•	•	•	•	•	•	•
Magnesium alloys	• ≤150 Bhn •	•	•	•	•	•	•	•	•	•	•	•	•
Copper, low-alloyed	• ≤120 Bhn •	•	•	•	•	•	•	•	•	•	•	•	•
Brass, short-chipping long-chipping	• ≤200 Bhn 920 • ≤200 Bhn •	920	•	0.0050	0.0080	0.0120	0.0125	0.0160	0.0200	•	•	•	•
Bronze, short-chipping	• ≤200 Bhn 360 • >200-260 Bhn 260 •	360 260	•	0.0040 0.0030	0.0060 0.0050	0.0095 0.0075	0.0100 0.0080	0.0125 0.0100	0.0160 0.0125	•	•	•	•
Bronze, long-chipping	• ≤24 Rc • >24-30 Rc •	•	•	•	•	•	•	•	•	•	•	•	•
Duroplastics	•	•	•	•	•	•	•	•	•	•	•	•	•
Thermoplastics	•	•	•	•	•	•	•	•	•	•	•	•	•
Reinforced plastics - Kevlar	•	•	•	•	•	•	•	•	•	•	•	•	•
Reinforced plastics - GFK / CFK	•	•	•	•	•	•	•	•	•	•	•	•	•

Series # 6070

Material group	Hardness	SFM	Feed Rate - IPR										
			1/16 in. 1.590 mm	1/8 in. 3.170 mm	1/4 in. 6.350 mm	3/8 in. 9.520 mm	1/2 in. 12.700 mm	5/8 in. 15.870 mm	3/4 in. 19.050 mm	1 in. 25.400 mm	1 1/4 in. 31.750 mm	1 1/2 in. 38.100 mm	
Common structural steels	≤100 Bhn >100-260 Bhn	•	•	•	•	•	•	•	•	•	•	•	•
Free-cutting steels	≤24 Rc >24-30 Rc	•	•	•	•	•	•	•	•	•	•	•	•
Unalloyed heat-treatable steels	≤16 Rc 16-24 Rc 24-30 Rc	•	•	•	•	•	•	•	•	•	•	•	•
Alloyed heat-treatable steels	24-30 Rc >30-38 Rc	•	•	•	•	•	•	•	•	•	•	•	•
Unalloyed case hardened steels	≤230 Bhn	•	•	•	•	•	•	•	•	•	•	•	•
Alloyed case hardened steels	24-30 Rc >30-38 Rc	•	•	•	•	•	•	•	•	•	•	•	•
Nitriding steels	≥24-30 Rc >30-38 Rc	•	•	•	•	•	•	•	•	•	•	•	•
Tool steels	≤24 Rc >24-30 Rc	•	•	•	•	•	•	•	•	•	•	•	•
High speed steels	≥14-30 Rc	•	•	•	•	•	•	•	•	•	•	•	•
Spring steels	≤330 Bhn	•	•	•	•	•	•	•	•	•	•	•	•
Stainless steels, sulphured austenitic martensitic	≤24 Rc • ≤24 Rc • ≤24 Rc •	•	•	•	•	•	•	•	•	•	•	•	•
Hardened steels	≤40-48 Rc >48-60 Rc	•	•	•	•	•	•	•	•	•	•	•	•
Special alloys	• ≤38 Rc •	•	•	•	•	•	•	•	•	•	•	•	•
Cast iron	≤240 Bhn 395 • ≤300 Bhn 330 •	395 330	•	0.0040 0.0040	0.0060 0.0060	0.0090 0.0090	0.0100 0.0100	0.0125 0.0125	0.0160 0.0160	•	•	•	•
Spheroidal graphite iron and malleable cast iron	≤240 Bhn 295 • ≤300 Bhn 260 •	295 260	•	0.0040 0.0040	0.0060 0.0060	0.0090 0.0090	0.0100 0.0100	0.0125 0.0125	0.0160 0.0160	•	•	•	•
Chilled cast iron	≤350 Bhn	130	•	0.0013	0.0020	0.0025	0.0030	0.0040	0.0050	•	•	•	•
Ti and Ti-alloys	• ≤24 Rc • >24-38 Rc •	•	•	•	•	•	•	•	•	•	•	•	•
Aluminium and Al-alloys	• ≤120 Bhn 1345 • ≤150 Bhn 1345 •	1345 1345	•	0.0040 0.0040	0.0060 0.0060	0.0090 0.0090	0.0100 0.0100	0.0125 0.0125	0.0160 0.0160	•	•	•	•
Al wrought alloys	• ≤150 Bhn 1345 •	1345	•	0.0040	0.0060	0.0090	0.0100	0.0125	0.0160	•	•	•	•
Al cast alloys ≤ 10 % Si	• ≤200 Bhn 1245 • ≤200 Bhn 1080 •	1245 1080	•	0.0040 0.0040	0.0060 0.0060	0.0090 0.0090	0.0100 0.0100	0.0125 0.0125	0.0160 0.0160	•	•	•	•
Al cast alloys > 10 % Si	•	•	•	•	•	•	•	•	•	•	•	•	•
Magnesium alloys	• ≤150 Bhn •	•	•	•	•	•	•	•	•	•	•	•	•
Copper, low-alloyed	• ≤120 Bhn •	•	•	•	•	•	•	•	•	•	•	•	•
Brass, short-chipping long-chipping	• ≤200 Bhn 920 • ≤200 Bhn •	920	•	0.0050	0.0080	0.0120	0.0125	0.0160	0.0200	•	•	•	•
Bronze, short-chipping	• ≤200 Bhn 360 • >200-260 Bhn 260 •	360 260	•	0.0040 0.0030	0.0060 0.0050	0.0090 0.0070	0.0100 0.0080	0.0125 0.0100	0.0160 0.0125	•	•	•	•
Bronze, long-chipping	• ≤24 Rc • >24-30 Rc •	•	•	•	•	•	•	•	•	•	•	•	•
Duroplastics	•	•	•	•	•	•	•	•	•	•	•	•	•
Thermoplastics	•	•	•	•	•	•	•	•	•	•	•	•	•
Reinforced plastics - Kevlar	•	•	•	•	•	•	•	•	•	•	•	•	•
Reinforced plastics - GFK / CFK	•	•	•	•	•	•	•	•	•	•	•	•	•

Note: Pilot holes (depth ≥1xD) are recommended when drilling depths greater than 7xD. The pilot hole can be produced with a short, rigid drill. The diameter should be 0.01 - 0.02 mm larger than the diameter of the finish drill. Ratio drills can produce their own pilot hole by reducing speed and feed rates by 30-40%.

Using These Tables. The Speeds & Feeds listed below are conservative recommendations for initial setup. In actual use, depending on the machining environment and workpiece material, significantly higher speeds and feeds may be achievable. Using the below as a starting point, cutting speed/feed can be gradually adjusted upwards until the optimum settings per application are found.
Questions? Contact us by telephone at (800) 776-6170.

Series # 6400

Material group	Hardness	SFM	Feed Rate - IPR					
			0.0315 in. 0.800 mm	0.0394 in. 1.000 mm	0.0591 in. 1.500 mm	0.0787 in. 2.000 mm	0.0984 in. 2.500 mm	0.1181 in. 3.000 mm
Common structural steels	≤100 Bhn >100-260 Bhn	295 - 395 295 - 360	0.0031 0.0031	0.0039 0.0039	0.0059 0.0059	0.0078 0.0078	0.0098 0.0098	0.0118 0.0118
Free-cutting steels	≤24 Rc >24-30 Rc	295 - 395 260 - 330	0.0031 0.0027	0.0039 0.0035	0.0059 0.0051	0.0078 0.007	0.0098 0.0086	0.0118 0.0106
Unalloyed heat-treatable steels	≤16 Rc 16-24 Rc 24-30 Rc	260 - 360 260 - 360 260 - 330	0.0031 0.0031 0.0027	0.0039 0.0039 0.0035	0.0059 0.0059 0.0051	0.0078 0.0078 0.007	0.0098 0.0098 0.0086	0.0118 0.0118 0.0106
Alloyed heat-treatable steels	24-30 Rc >30-38 Rc	260 - 330 197 - 260	0.0027 0.0023	0.0035 0.0031	0.0051 0.0047	0.007 0.0062	0.0086 0.0078	0.0106 0.0094
Unalloyed case hardened steels	≤230 Bhn	295 - 360	0.0027	0.0035	0.0051	0.007	0.0086	0.0106
Alloyed case hardened steels	24-30 Rc >30-38 Rc	230 - 330 200 - 260	0.0027 0.0023	0.0035 0.0031	0.0051 0.0047	0.007 0.0062	0.0086 0.0078	0.0106 0.0094
Nitriding steels	≥24-30 Rc >30-38 Rc	200 - 260 165 - 230	0.0023 0.0023	0.0031 0.0031	0.0047 0.0047	0.0062 0.0062	0.0078 0.0078	0.0094 0.0094
Tool steels	≤24 Rc >24-30 Rc	130 - 200 130 - 200	0.0023 0.0023	0.0031 0.0031	0.0047 0.0047	0.0062 0.0062	0.0078 0.0078	0.0094 0.0094
High speed steels	≥14-30 Rc	130 - 200	0.0006	0.0009	0.0014	0.002	0.0027	0.0035
Spring steels	≤330 Bhn	130 - 200	0.0006	0.0009	0.0014	0.002	0.0027	0.0035
Stainless steels, sulphured austenitic martensitic	≤24 Rc ≤24 Rc ≤24 Rc	100 50 100	0.0006 0.0003 0.0006	0.0009 0.0004 0.0009	0.0014 0.0008 0.0014	0.002 0.0012 0.002	0.0027 0.0017 0.0027	0.0035 0.0023 0.0035
Hardened steels	≤40-48 Rc >48-60 Rc							
Special alloys	≤38 Rc	35	0.0003	0.0004	0.0008	0.0012	0.0017	0.0023
Cast iron	≤240 Bhn <300 Bhn	< 490 < 460	0.0035 0.0035	0.0047 0.0047	0.007 0.007	0.0094 0.0094	0.0118 0.0118	0.0141 0.0141
Spheroidal graphite iron and malleable cast iron	≤240 Bhn <300 Bhn	< 460 < 425	0.0035 0.0035	0.0047 0.0047	0.007 0.0066	0.0094 0.009	0.0118 0.011	0.0141 0.0133
Chilled cast iron	≤350 Bhn							
Ti and Ti-alloys	≤24 Rc >24-38 Rc	50 50	0.0003 0.0003	0.0004 0.0004	0.0008 0.0008	0.0012 0.0012	0.0017 0.0017	0.0023 0.0023
Aluminium and Al-alloys	≤120 Bhn	200 - 260	0.0035	0.0047	0.007	0.0094	0.0118	0.0141
Al wrought alloys	≤150 Bhn	200 - 260	0.0035	0.0047	0.007	0.0094	0.0118	0.0141
Al cast alloys ≤ 10 % Si > 10 % Si	≤200 Bhn ≤200 Bhn	395 - 490 395 - 490	0.0012 0.0012	0.0016 0.0016	0.0026 0.0026	0.0036 0.0036	0.0047 0.0047	0.0059 0.0059
Magnesium alloys	≤150 Bhn							
Copper, low-alloyed	≤120 Bhn							
Brass, short-chipping long-chipping	≤200 Bhn ≤200 Bhn							
Bronze, short-chipping	≤200 Bhn >200-260 Bhn							
Bronze, long-chipping	≤24 Rc >24-30 Rc							
Duroplastics Thermoplastics Reinforced plastics - Kevlar Reinforced plastics - GFK / CFK	- - - -							

Series # 6401

Material group	Hardness	SFM	Feed Rate - IPR					
			0.0315 in. 0.800 mm	0.0394 in. 1.000 mm	0.0591 in. 1.500 mm	0.0787 in. 2.000 mm	0.0984 in. 2.500 mm	0.1181 in. 3.000 mm
Common structural steels	≤100 Bhn >100-260 Bhn	295 - 395 295 - 360	0.0023 0.0023	0.0031 0.0031	0.0047 0.0047	0.0062 0.0062	0.0078 0.0078	0.0094 0.0094
Free-cutting steels	≤24 Rc >24-30 Rc	295 - 395 260 - 330	0.0023 0.0019	0.0031 0.0027	0.0047 0.0039	0.0062 0.0055	0.0078 0.0066	0.0094 0.0082
Unalloyed heat-treatable steels	≤16 Rc 16-24 Rc 24-30 Rc	260 - 360 260 - 360 260 - 330	0.0023 0.0023 0.0019	0.0031 0.0031 0.0019	0.0047 0.0047 0.0039	0.0062 0.0062 0.0055	0.0078 0.0078 0.0066	0.0094 0.0094 0.0082
Alloyed heat-treatable steels	24-30 Rc >30-38 Rc	260 - 330 197 - 260	0.0019 0.0015	0.0027 0.0023	0.0039 0.0035	0.0055 0.0047	0.0066 0.0059	0.0082 0.007
Unalloyed case hardened steels	≤230 Bhn	295 - 360	0.0019	0.0027	0.0039	0.0055	0.0066	0.0082
Alloyed case hardened steels	24-30 Rc >30-38 Rc	230 - 330 200 - 260	0.0019 0.0015	0.0027 0.0023	0.0039 0.0035	0.0055 0.0047	0.0066 0.0059	0.0082 0.007
Nitriding steels	≥24-30 Rc >30-38 Rc	200 - 260 165 - 230	0.0015 0.0015	0.0023 0.0023	0.0035 0.0035	0.0047 0.0047	0.0059 0.0059	0.007 0.007
Tool steels	≤24 Rc >24-30 Rc	130 - 200 130 - 200	0.0015 0.0015	0.0023 0.0023	0.0035 0.0035	0.0047 0.0047	0.0059 0.0059	0.007 0.007
High speed steels	≥14-30 Rc	130 - 200	0.0006	0.0008	0.0014	0.002	0.0023	0.0035
Spring steels	≤330 Bhn	130 - 200	0.0006	0.0008	0.0014	0.002	0.0023	0.0035
Stainless steels, sulphured austenitic martensitic	≤24 Rc ≤24 Rc ≤24 Rc	100 50 100	0.0006 0.0003 0.0006	0.0008 0.0004 0.0008	0.0014 0.0008 0.0014	0.002 0.0012 0.002	0.0023 0.0017 0.0023	0.0035 0.0023 0.0035
Hardened steels	≤40-48 Rc >48-60 Rc							
Special alloys	≤38 Rc	35	0.0003	0.0004	0.0008	0.0012	0.0017	0.0023
Cast iron	≤240 Bhn <300 Bhn	< 490 < 460	0.0031 0.0031	0.0043 0.0043	0.0062 0.0062	0.0086 0.0086	0.01 0.01	0.0129 0.0129
Spheroidal graphite iron and malleable cast iron	≤240 Bhn <300 Bhn	< 460 < 425	0.0031 0.0031	0.0043 0.0039	0.0062 0.0059	0.0086 0.0082	0.01 0.01	0.0129 0.0122
Chilled cast iron	≤350 Bhn							
Ti and Ti-alloys	≤24 Rc >24-38 Rc	50 50	0.0003 0.0003	0.0004 0.0004	0.0008 0.0008	0.0012 0.0012	0.0017 0.0017	0.0023 0.0023
Aluminium and Al-alloys	≤120 Bhn	200 - 260	0.0035	0.0047	0.007	0.0094	0.0118	0.014
Al wrought alloys	≤150 Bhn	200 - 260	0.0035	0.0047	0.007	0.0094	0.0118	0.014
Al cast alloys ≤ 10 % Si > 10 % Si	≤200 Bhn ≤200 Bhn	395 - 490 395 - 490	0.0012 0.0012	0.0016 0.0016	0.0025 0.0025	0.0036 0.0036	0.0047 0.0047	0.0059 0.0059
Magnesium alloys	≤150 Bhn							
Copper, low-alloyed	≤120 Bhn							
Brass, short-chipping long-chipping	≤200 Bhn ≤200 Bhn							
Bronze, short-chipping	≤200 Bhn >200-260 Bhn							
Bronze, long-chipping	≤24 Rc >24-30 Rc							
Duroplastics Thermoplastics Reinforced plastics - Kevlar Reinforced plastics - GFK / CFK	- - - -							

$$\text{RPM} = \frac{\text{SFM}}{\text{DIAM. in.}} \times 3.82 \quad \text{IPM} = \text{IPR} \times \text{RPM}$$

$$\text{HOLE DEPTH in.} \times 60 = \text{Cut Time IPM}$$

$$\text{mm} = \text{in.} \times 25.40$$

$$\text{m/min.} = \text{SFM} \div 3.28$$

$$\text{mm/rev.} = \text{IPR} \times 25.40$$

$$\text{Bar} = \text{PSI} \div 14.50$$

$$\text{Liter} = \text{Gal.} \div 3.79$$

Series # 6405

Material group	Hardness	SFM	Feed Rate - IPR					
			0.0315 in. 0.800 mm	0.0394 in. 1.000 mm	0.0591 in. 1.500 mm	0.0787 in. 2.000 mm	0.0984 in. 2.500 mm	0.1181 in. 3.000 mm
Common structural steels	≤100 Bhn >100-260 Bhn	295 - 395 295 - 360	0.0023 0.0023	0.0031 0.0031	0.0047 0.0047	0.0062 0.0062	0.0078 0.0078	0.0094 0.0094
Free-cutting steels	≤24 Rc >24-30 Rc	295 - 395 260 - 330	0.0023 0.0019	0.0031 0.0027	0.0047 0.0039	0.0062 0.0055	0.0078 0.0066	0.0094 0.0082
Unalloyed heat-treatable steels	≤16 Rc 16-24 Rc 24-30 Rc	260 - 360 260 - 360 260 - 330	0.0023 0.0023 0.0019	0.0031 0.0031 0.0027	0.0047 0.0047 0.0039	0.0062 0.0062 0.0055	0.0078 0.0078 0.0066	0.0094 0.0094 0.0082
Alloyed heat-treatable steels	24-30 Rc >30-38 Rc	260 - 330 197 - 260	0.0019 0.0015	0.0027 0.0023	0.0039 0.0035	0.0055 0.0047	0.0066 0.0059	0.0082 0.007
Unalloyed case hardened steels	≤230 Bhn	295 - 360	0.0019	0.0027	0.0039	0.0055	0.0066	0.0082
Alloyed case hardened steels	24-30 Rc >30-38 Rc	230 - 330 200 - 260	0.0019 0.0015	0.0027 0.0023	0.0039 0.0035	0.0055 0.0047	0.0066 0.0059	0.0082 0.007
Nitriding steels	≥24-30 Rc >30-38 Rc	200 - 260 165 - 230	0.0015 0.0015	0.0023 0.0023	0.0035 0.0035	0.0047 0.0047	0.0059 0.0059	0.007 0.007
Tool steels	≤24 Rc >24-30 Rc	130 - 200 130 - 200	0.0015 0.0015	0.0023 0.0023	0.0035 0.0035	0.0047 0.0047	0.0059 0.0059	0.007 0.007
High speed steels	≤14-30 Rc	130 - 200	0.0006	0.0008	0.0014	0.002	0.0023	0.0035
Spring steels	≤330 Bhn	130 - 200	0.0006	0.0008	0.0014	0.002	0.0023	0.0035
Stainless steels, sulphured	≤24 Rc	200 - 260	0.0006	0.0008	0.0014	0.002	0.0023	0.0035
austenitic	≤24 Rc	200	0.0003	0.0004	0.0008	0.0012	0.0017	0.0023
martensitic	≤24 Rc	200 - 260	0.0006	0.0008	0.0014	0.002	0.0023	0.0035
Hardened steels	≤40-48 Rc >48-60 Rc							
Special alloys	≤38 Rc	35	0.0003	0.0004	0.0008	0.0012	0.0017	0.0023
Cast iron	≤240 Bhn <300 Bhn	< 490 < 460	0.0015 0.0015	0.0023 0.0023	0.0035 0.0035	0.0047 0.0047	0.0059 0.0059	0.007 0.007
Spheroidal graphite iron and malleable cast iron	≤240 Bhn <300 Bhn	< 460 < 425	0.0015 0.0015	0.0023 0.0023	0.0035 0.0035	0.0047 0.0047	0.0059 0.0059	0.007 0.007
Chilled cast iron	≤350 Bhn							
Ti and Ti-alloys	≤24 Rc >24-38 Rc	50 50	0.0003 0.0003	0.0004 0.0004	0.0008 0.0008	0.0012 0.0012	0.0017 0.0017	0.0023 0.0023
Aluminium and Al-alloys	≤120 Bhn	200 - 260	0.0035	0.0047	0.007	0.0094	0.0118	0.014
Al wrought alloys	≤150 Bhn	200 - 260	0.0035	0.0047	0.007	0.0094	0.0118	0.014
Al cast alloys ≤ 10 % Si	≤200 Bhn	395 - 490	0.0012	0.0016	0.0025	0.0036	0.0047	0.0059
> 10 % Si	≤200 Bhn	395 - 490	0.0012	0.0016	0.0025	0.0036	0.0047	0.0059
Magnesium alloys	≤150 Bhn							
Copper, low-alloyed	≤120 Bhn							
Brass, short-chipping	≤200 Bhn							
long-chipping	≤200 Bhn							
Bronze, short-chipping	≤200 Bhn							
>200-260 Bhn								
Bronze, long-chipping	≤24 Rc >24-30 Rc							
Duroplastics	-							
Thermoplastics	-							
Reinforced plastics - Kevlar	-							
Reinforced plastics - GFK / CFK	-							

Series # 6408 and 6412

Material group	Hardness	SFM	Feed Rate - IPR					
			0.0315 in. 0.800 mm	0.0394 in. 1.000 mm	0.0591 in. 1.500 mm	0.0787 in. 2.000 mm	0.0984 in. 2.500 mm	0.1181 in. 3.000 mm
Common structural steels	≤100 Bhn >100-260 Bhn	295 - 395 295 - 360	0.0009 0.0009	0.0012 0.0012	0.002 0.002	0.0028 0.0028	0.0037 0.0037	0.0047 0.0047
Free-cutting steels	≤24 Rc >24-30 Rc	295 - 395 260 - 330	0.0012 0.0012	0.0016 0.0016	0.0026 0.0026	0.0036 0.0036	0.0047 0.0047	0.006 0.006
Unalloyed heat-treatable steels	≤16 Rc 16-24 Rc 24-30 Rc	260 - 360 260 - 360 260 - 330	0.0009 0.0009 0.0009	0.0012 0.0012 0.0012	0.002 0.002 0.002	0.0028 0.0028 0.0028	0.0037 0.0037 0.0037	0.0047 0.0047 0.0047
Alloyed heat-treatable steels	24-30 Rc >30-38 Rc	260 - 328 200 - 260	0.0009 0.0009	0.0012 0.0012	0.002 0.002	0.0028 0.0028	0.0037 0.0037	0.0047 0.0047
Unalloyed case hardened steels	≤230 Bhn	295 - 360	0.0006	0.0008	0.0014	0.002	0.0027	0.0035
Alloyed case hardened steels	24-30 Rc >30-38 Rc	230 - 330 200 - 260	0.0009 0.0009	0.0012 0.0012	0.002 0.002	0.0028 0.0028	0.0037 0.0037	0.0047 0.0047
Nitriding steels	≥24-30 Rc >30-38 Rc	200 - 260 165 - 230	0.0006 0.0006	0.0008 0.0008	0.0014 0.0014	0.002 0.002	0.0027 0.0027	0.0035 0.0035
Tool steels	≤24 Rc >24-30 Rc	130 - 200 130 - 200	0.0009 0.0009	0.0012 0.0012	0.002 0.002	0.0028 0.0028	0.0037 0.0037	0.0047 0.0047
High speed steels	≥14-30 Rc	130 - 200	0.0006	0.0008	0.0014	0.002	0.0027	0.0035
Spring steels	≤330 Bhn	130 - 200	0.0006	0.0008	0.0014	0.002	0.0027	0.0035
Stainless steels, sulphured	≤24 Rc	200 - 260	0.0006	0.0008	0.0014	0.002	0.0027	0.0035
austenitic	≤24 Rc	200	0.0003	0.0004	0.0008	0.0012	0.0018	0.0023
martensitic	≤24 Rc	200 - 260	0.0006	0.0008	0.0014	0.002	0.0027	0.0035
Hardened steels	≤40-48 Rc >48-60 Rc							
Special alloys	≤38 Rc	80	0.0003	0.0004	0.0008	0.0012	0.0018	0.0023
Cast iron	≤240 Bhn <300 Bhn	< 490 < 460	0.0015 0.0015	0.0023 0.0023	0.0035 0.0035	0.0047 0.0047	0.006 0.006	0.007 0.007
Spheroidal graphite iron and malleable cast iron	≤240 Bhn <300 Bhn	< 460 < 425	0.0015 0.0015	0.0023 0.0023	0.0035 0.0035	0.0047 0.0047	0.006 0.006	0.007 0.007
Chilled cast iron	≤350 Bhn							
Ti and Ti-alloys	≤24 Rc >24-38 Rc	115 115	0.0003 0.0003	0.0004 0.0004	0.0008 0.0008	0.0012 0.0012	0.0018 0.0018	0.0023 0.0023
Aluminium and Al-alloys	≤120 Bhn	200 - 260	0.0035	0.0047	0.007	0.0094	0.012	0.014
Al wrought alloys	≤150 Bhn	200 - 260	0.0035	0.0047	0.007	0.0094	0.012	0.014
Al cast alloys ≤ 10 % Si	≤200 Bhn	395 - 490	0.0012	0.0016	0.0025	0.0036	0.0047	0.006
> 10 % Si	≤200 Bhn	395 - 490	0.0012	0.0016	0.0025	0.0036	0.0047	0.006
Magnesium alloys	≤150 Bhn							
Copper, low-alloyed	≤120 Bhn							
Brass, short-chipping	≤200 Bhn							
long-chipping	≤200 Bhn							
Bronze, short-chipping	≤200 Bhn							
>200-260 Bhn								
Bronze, long-chipping	≤24 Rc >24-30 Rc							
Duroplastics	-							
Thermoplastics	-							
Reinforced plastics - Kevlar	-							
Reinforced plastics - GFK / CFK	-							

Note: Pilot holes (depth ≥1xD) are recommended when drilling depths greater than 7xD. The pilot hole can be produced with a short, rigid drill. The diameter should be 0.01 - 0.02 mm larger than the diameter of the finish drill. Ratio drills can produce their own pilot hole by reducing speed and feed rates by 30-40%.

Using These Tables. The Speeds & Feeds listed below are conservative recommendations for initial setup. In actual use, depending on the machining environment and workpiece material, significantly higher speeds and feeds may be achievable. Using the below as a starting point, cutting speed/feed can be gradually adjusted upwards until the optimum settings per application are found.

Questions? Contact us by telephone at (800) 776-6170.

Series # 6501

Material group	Hardness	SFM	Feed Rate - IPR									
			1/16 in. 1.590 mm	1/8 in. 3.170 mm	1/4 in. 6.350 mm	3/8 in. 9.520 mm	1/2 in. 12.700 mm	5/8 in. 15.870 mm	3/4 in. 19.050 mm	1 in. 25.400 mm	1 1/4 in. 31.750 mm	1 1/2 in. 38.100 mm
Common structural steels	≤100 Bhn >100-260 Bhn	• •	• •	• •	• •	• •	• •	• •	• •	• •	• •	• •
Free-cutting steels	≤24 Rc >24-30 Rc	• •	• •	• •	• •	• •	• •	• •	• •	• •	• •	• •
Unalloyed heat-treatable steels	≤16 Rc 16-24 Rc 24-30 Rc	• • •	• • •	• • •	• • •	• • •	• • •	• • •	• • •	• • •	• • •	• • •
Alloyed heat-treatable steels	24-30 Rc >30-38 Rc	• •	• •	• •	• •	• •	• •	• •	• •	• •	• •	• •
Unalloyed case hardened steels	≤230 Bhn	•	•	•	•	•	•	•	•	•	•	•
Alloyed case hardened steels	24-30 Rc >30-38 Rc	• •	• •	• •	• •	• •	• •	• •	• •	• •	• •	• •
Nitriding steels	≥24-30 Rc >30-38 Rc	• •	• •	• •	• •	• •	• •	• •	• •	• •	• •	• •
Tool steels	≤24 Rc >24-30 Rc	• •	• •	• •	• •	• •	• •	• •	• •	• •	• •	• •
High speed steels	≥14-30 Rc	•	•	•	•	•	•	•	•	•	•	•
Spring steels	≤330 Bhn	•	•	•	•	•	•	•	•	•	•	•
Stainless steels, sulphured	≤24 Rc	•	•	•	•	•	•	•	•	•	•	•
austenitic	≤24 Rc	•	•	•	•	•	•	•	•	•	•	•
martensitic	≤24 Rc	•	•	•	•	•	•	•	•	•	•	•
Hardened steels	≤40-48 Rc >48-60 Rc	• •	• •	• •	• •	• •	• •	• •	• •	• •	• •	• •
Special alloys	≤38 Rc	•	•	•	•	•	•	•	•	•	•	•
Cast iron	≤240 Bhn <300 Bhn	685 520	• •	0.0060 0.0060	0.0125 0.0125	0.0160 0.0160	0.0200 0.0200	0.0250 0.0250	0.0250 0.0250	• •	• •	• •
Spheroidal graphite iron and malleable cast iron	≤240 Bhn <300 Bhn	520 425	• •	0.0060 0.0060	0.0125 0.0100	0.0160 0.0160	0.0200 0.0160	0.0250 0.0200	0.0250 0.0250	• •	• •	• •
Chilled cast iron	≤350 Bhn	•	•	•	•	•	•	•	•	•	•	•
CGI	<220 Bhn <300 Bhn	425 325	• •	0.0060 0.0060	0.0100 0.0100	0.0150 0.0150	0.0160 0.0160	0.0200 0.0200	0.0250 0.0250	• •	• •	• •
ADI	800-1000 (N/mm²) 1200-1400 (N/mm²)	260 195	• •	0.0060 0.0060	0.0100 0.0100	0.0150 0.0150	0.0160 0.0160	0.0200 0.0200	0.0250 0.0250	• •	• •	• •
Aluminium and Al-alloys	≤120 Bhn	•	•	•	•	•	•	•	•	•	•	•
Al wrought alloys	≤150 Bhn	•	•	•	•	•	•	•	•	•	•	•
Al cast alloys ≤ 10 % Si	≤200 Bhn	•	•	•	•	•	•	•	•	•	•	•
> 10 % Si	≤200 Bhn	•	•	•	•	•	•	•	•	•	•	•
Magnesium alloys	≤150 Bhn	•	•	•	•	•	•	•	•	•	•	•
Copper, low-alloyed	≤120 Bhn	•	•	•	•	•	•	•	•	•	•	•
Brass, short-chipping	≤200 Bhn	•	•	•	•	•	•	•	•	•	•	•
long-chipping	≤200 Bhn	•	•	•	•	•	•	•	•	•	•	•
Bronze, short-chipping	≤200 Bhn >200-260 Bhn	• •	• •	• •	• •	• •	• •	• •	• •	• •	• •	• •
Bronze, long-chipping	≤24 Rc >24-30 Rc	• •	• •	• •	• •	• •	• •	• •	• •	• •	• •	• •
Duroplastics	—	•	•	•	•	•	•	•	•	•	•	•
Thermoplastics	—	•	•	•	•	•	•	•	•	•	•	•

Series # 6502

Material group	Hardness	SFM	Feed Rate - IPR									
			1/16 in. 1.590 mm	1/8 in. 3.170 mm	1/4 in. 6.350 mm	3/8 in. 9.520 mm	1/2 in. 12.700 mm	5/8 in. 15.870 mm	3/4 in. 19.050 mm	1 in. 25.400 mm	1 1/4 in. 31.750 mm	1 1/2 in. 38.100 mm
Common structural steels	≤100 Bhn >100-260 Bhn	• •	• •	• •	• •	• •	• •	• •	• •	• •	• •	• •
Free-cutting steels	≤24 Rc >24-30 Rc	• •	• •	• •	• •	• •	• •	• •	• •	• •	• •	• •
Unalloyed heat-treatable steels	≤16 Rc 16-24 Rc 24-30 Rc	• • •	• • •	• • •	• • •	• • •	• • •	• • •	• • •	• • •	• • •	• • •
Alloyed heat-treatable steels	24-30 Rc >30-38 Rc	• •	• •	• •	• •	• •	• •	• •	• •	• •	• •	• •
Unalloyed case hardened steels	≤230 Bhn	•	•	•	•	•	•	•	•	•	•	•
Alloyed case hardened steels	24-30 Rc >30-38 Rc	• •	• •	• •	• •	• •	• •	• •	• •	• •	• •	• •
Nitriding steels	≥24-30 Rc >30-38 Rc	• •	• •	• •	• •	• •	• •	• •	• •	• •	• •	• •
Tool steels	≤24 Rc >24-30 Rc	• •	• •	• •	• •	• •	• •	• •	• •	• •	• •	• •
High speed steels	≥14-30 Rc	•	•	•	•	•	•	•	•	•	•	•
Spring steels	≤330 Bhn	•	•	•	•	•	•	•	•	•	•	•
Stainless steels, sulphured	≤24 Rc	•	•	•	•	•	•	•	•	•	•	•
austenitic	≤24 Rc	•	•	•	•	•	•	•	•	•	•	•
martensitic	≤24 Rc	•	•	•	•	•	•	•	•	•	•	•
Hardened steels	≤40-48 Rc >48-60 Rc	• •	• •	• •	• •	• •	• •	• •	• •	• •	• •	• •
Special alloys	≤38 Rc	•	•	•	•	•	•	•	•	•	•	•
Cast iron	≤240 Bhn <300 Bhn	685 520	• •	0.0060 0.0060	0.0100 0.0100	0.0160 0.0160	0.0160 0.0160	0.0200 0.0200	0.0250 0.0250	• •	• •	• •
Spheroidal graphite iron and malleable cast iron	≤240 Bhn <300 Bhn	520 425	• •	0.0060 0.0050	0.0100 0.0080	0.0160 0.0125	0.0160 0.0125	0.0200 0.0160	0.0250 0.0200	• •	• •	• •
Chilled cast iron	≤350 Bhn	•	•	•	•	•	•	•	•	•	•	•
CGI	<220 Bhn <300 Bhn	425 325	• •	0.0050 0.0050	0.0080 0.0080	0.0120 0.0120	0.0125 0.0125	0.0160 0.0160	0.0200 0.0200	• •	• •	• •
ADI	800-1000 (N/mm²) 1200-1400 (N/mm²)	260 195	• •	0.0050 0.0050	0.0080 0.0080	0.0120 0.0120	0.0125 0.0125	0.0160 0.0160	0.0200 0.0200	• •	• •	• •
Aluminium and Al-alloys	≤120 Bhn	•	•	•	•	•	•	•	•	•	•	•
Al wrought alloys	≤150 Bhn	•	•	•	•	•	•	•	•	•	•	•
Al cast alloys ≤ 10 % Si	≤200 Bhn	•	•	•	•	•	•	•	•	•	•	•
> 10 % Si	≤200 Bhn	•	•	•	•	•	•	•	•	•	•	•
Magnesium alloys	≤150 Bhn	•	•	•	•	•	•	•	•	•	•	•
Copper, low-alloyed	≤120 Bhn	•	•	•	•	•	•	•	•	•	•	•
Brass, short-chipping	≤200 Bhn	•	•	•	•	•	•	•	•	•	•	•
long-chipping	≤200 Bhn	•	•	•	•	•	•	•	•	•	•	•
Bronze, short-chipping	≤200 Bhn >200-260 Bhn	• •	• •	• •	• •	• •	• •	• •	• •	• •	• •	• •
Bronze, long-chipping	≤24 Rc >24-30 Rc	• •	• •	• •	• •	• •	• •	• •	• •	• •	• •	• •
Duroplastics	—	•	•	•	•	•	•	•	•	•	•	•
Thermoplastics	—	•	•	•	•	•	•	•	•	•	•	•

$RPM = \frac{SFM}{DIAM. \text{ in.}} \times 3.82$ $IPM = IPR \times RPM$

$\frac{HOLE \ DEPTH \ \text{in.}}{IPM} \times 60 = \text{Cut Time}$ $mm = \text{in.} \times 25.40$

$m/\text{min.} = SFM \div 3.28$ $Bar = PSI \div 14.50$
 $mm/\text{rev.} = IPR \times 25.40$ $Liter = Gal. \div 3.79$

Series # 6509 and 6511

Material group	Hardness	SFM	Feed Rate - IPR											
			1/16 in. 1.590 mm	1/8 in. 3.170 mm	1/4 in. 6.350 mm	3/8 in. 9.520 mm	1/2 in. 12.700 mm	5/8 in. 15.870 mm	3/4 in. 19.050 mm	1 in. 25.400 mm	1 1/4 in. 31.750 mm	1 1/2 in. 38.100 mm		
Common structural steels	≤100 Bhn	360	0.004	0.006	0.010	0.014	0.016	0.020						
	>100-260 Bhn	360	0.004	0.006	0.010	0.014	0.016	0.020						
Free-cutting steels	≤24 Rc	395	0.004	0.006	0.010	0.014	0.016	0.020						
	>24-30 Rc	395	0.004	0.006	0.010	0.014	0.016	0.020						
Unalloyed heat-treatable steels	≤16 Rc	360	0.003	0.004	0.006	0.009	0.010	0.012						
	16-24 Rc	360	0.004	0.006	0.010	0.014	0.016	0.020						
	24-30 Rc	330	0.003	0.005	0.008	0.011	0.012	0.016						
Alloyed heat-treatable steels	24-30 Rc	360	0.003	0.005	0.008	0.011	0.012	0.016						
	>30-38 Rc	360	0.003	0.004	0.006	0.009	0.010	0.012						
Unalloyed case hardened steels	≤230 Bhn	360	0.004	0.006	0.010	0.014	0.016	0.020						
Alloyed case hardened steels	24-30 Rc	360	0.003	0.005	0.008	0.011	0.012	0.016						
	>30-38 Rc	360	0.003	0.004	0.006	0.009	0.010	0.012						
Nitriding steels	≥24-30 Rc	330	0.002	0.003	0.005	0.007	0.008	0.010						
	>30-38 Rc	260	0.002	0.003	0.005	0.005	0.007	0.008	0.010					
Tool steels	≤24 Rc	330	0.003	0.004	0.006	0.009	0.010	0.012						
	>24-30 Rc	260	0.002	0.003	0.005	0.005	0.007	0.008	0.010					
High speed steels	≥14-30 Rc	165	0.002	0.003	0.005	0.007	0.008	0.010						
Spring steels	≤330 Bhn	165	0.002	0.003	0.005	0.007	0.008	0.010						
Stainless steels, sulphured	≤24 Rc	330	0.002	0.003	0.005	0.007	0.008	0.010						
	austenitic	230	0.001	0.002	0.002	0.004	0.004	0.005						
	martensitic	330	0.002	0.003	0.005	0.007	0.008	0.010						
Hardened steels	≤40-48 Rc	165	0.002	0.002	0.004	0.006	0.006	0.008						
	>48-60 Rc	165	0.001	0.002	0.004	0.006	0.006	0.008						
Special alloys	≤38 Rc	100	0.004	0.002	0.002	0.004	0.004	0.005						
Cast iron	≤240 Bhn	460	0.004	0.006	0.010	0.014	0.016	0.020						
	<300 Bhn	330	0.004	0.006	0.010	0.014	0.016	0.020						
Spheroidal graphite iron and malleable cast iron	≤240 Bhn	460	0.004	0.006	0.010	0.014	0.016	0.020						
	<300 Bhn	330	0.004	0.006	0.010	0.014	0.016	0.020						
Chilled cast iron	≤350 Bhn						
Ti and Ti-alloys	≤24 Rc						
	>24-38 Rc						
Aluminium and Al-alloys	≤120 Bhn						
Al wrought alloys	≤150 Bhn						
Al cast alloys ≤ 10 % Si	≤200 Bhn						
	> 10 % Si	≤200 Bhn						
Magnesium alloys	≤150 Bhn						
Copper, low-alloyed	≤120 Bhn	395	.	0.001	0.002	0.003	0.003	0.004						
Brass, short-chipping	≤200 Bhn	395	0.004	0.006	0.010	0.014	0.016	0.020						
	long-chipping	≤200 Bhn												
Bronze, short-chipping	≤200 Bhn													
	>200-260 Bhn													
Bronze, long-chipping	≤24 Rc													
	>24-30 Rc													
Duroplastics	-													
Thermoplastics	-													
Reinforced plastics - Kevlar	-													
Reinforced plastics - GFK / CFK	-													

Note: Pilot holes (depth >1xD) are recommended when using RT100T drills. Use a series 5514 or similar drill to drill a minimum of 1xD deep. Then enter the pilot hole with the RT100T drill at approx 300 rev/min and 500 mm/min speed, start high coolant pressure and increase RPM. Drill to hole depth without pecking.

Series # 6512

Material group	Hardness	SFM	Feed Rate - IPR											
			1/16 in. 1.590 mm	1/8 in. 3.170 mm	1/4 in. 6.350 mm	3/8 in. 9.520 mm	1/2 in. 12.700 mm	5/8 in. 15.870 mm	3/4 in. 19.050 mm	1 in. 25.400 mm	1 1/4 in. 31.750 mm	1 1/2 in. 38.100 mm		
Common structural steels	≤100 Bhn	330	0.004	0.006	0.010	0.014	0.016	0.020						
	>100-260 Bhn	330	0.004	0.006	0.010	0.014	0.016	0.020						
Free-cutting steels	≤24 Rc	395	0.004	0.006	0.010	0.014	0.016	0.020						
	>24-30 Rc	330	0.004	0.006	0.010	0.014	0.016	0.020						
Unalloyed heat-treatable steels	≤16 Rc	360	0.003	0.004	0.006	0.009	0.010	0.012						
	16-24 Rc	330	0.004	0.006	0.010	0.014	0.016	0.020						
	24-30 Rc	330	0.003	0.005	0.008	0.011	0.012	0.016						
Alloyed heat-treatable steels	24-30 Rc	330	0.003	0.005	0.008	0.011	0.012	0.016						
	>30-38 Rc	330	0.003	0.004	0.006	0.009	0.010	0.012						
Unalloyed case hardened steels	≤230 Bhn	330	0.004	0.006	0.010	0.014	0.016	0.020						
Alloyed case hardened steels	24-30 Rc	330	0.003	0.005	0.008	0.011	0.012	0.016						
	>30-38 Rc	330	0.003	0.004	0.006	0.009	0.010	0.012						
Nitriding steels	≥24-30 Rc	260	0.002	0.003	0.005	0.007	0.008	0.010						
	>30-38 Rc	195	0.002	0.003	0.005	0.007	0.008	0.010						
Tool steels	≤24 Rc	295	0.003	0.004	0.006	0.009	0.010	0.012						
	>24-30 Rc	230	0.002	0.002	0.004	0.006	0.006	0.008						
High speed steels	≥14-30 Rc	165	0.002	0.002	0.004	0.006	0.006	0.008						
Spring steels	≤330 Bhn	165	0.002	0.002	0.004	0.006	0.006	0.008						
Stainless steels, sulphured	≤24 Rc	330	0.002	0.003	0.005	0.007	0.008	0.010						
	austenitic	230	0.001	0.002	0.002	0.004	0.004	0.005						
	martensitic	330	0.002	0.003	0.005	0.007	0.008	0.010						
Hardened steels	≤40-48 Rc	165	0.002	0.002	0.004	0.006	0.006	0.008						
	>48-60 Rc	165	0.001	0.002	0.004	0.006	0.006	0.008						
Special alloys	≤38 Rc	100	0.004	0.002	0.002	0.004	0.004	0.005						
Cast iron	≤240 Bhn	425	0.004	0.006	0.010	0.014	0.016	0.020						
	<300 Bhn	295	0.004	0.006	0.010	0.014	0.016	0.020						
Spheroidal graphite iron and malleable cast iron	≤240 Bhn	425	0.004	0.006	0.010	0.014	0.016	0.020						
	<300 Bhn	295	0.004	0.006	0.010	0.014	0.016	0.020						
Chilled cast iron	≤350 Bhn						
Ti and Ti-alloys	≤24 Rc						
	>24-38 Rc						
Aluminium and Al-alloys	≤120 Bhn						
Al wrought alloys	≤150 Bhn						
Al cast alloys ≤ 10 % Si	≤200 Bhn						
	> 10 % Si	≤200 Bhn						
Magnesium alloys	≤150 Bhn						
Copper, low-alloyed	≤120 Bhn	395	.	0.001	0.002	0.003	0.003	0.004						
Brass, short-chipping	≤200 Bhn	360	0.004	0.006	0.010	0.014	0.016	0.020						
	long-chipping	≤200 Bhn												
Bronze, short-chipping	≤200 Bhn													
	>200-260 Bhn													
Bronze, long-chipping	≤24 Rc													
	>24-30 Rc													
Duroplastics	-													
Thermoplastics	-													
Reinforced plastics - Kevlar	-													
Reinforced plastics - GFK / CFK	-													

Note: Pilot holes (depth >1xD) are recommended when using RT100T drills. Use a series 5514 or similar drill to drill a minimum of 1xD deep. Then enter the pilot hole with the RT100T drill at approx 300 rev/min and 500 mm/min speed, start high coolant pressure and increase RPM. Drill to hole depth without pecking.

Using These Tables. The Speeds & Feeds listed below are conservative recommendations for initial setup. In actual use, depending on the machining environment and workpiece material, significantly higher speeds and feeds may be achievable. Using the below as a starting point, cutting speed/feed can be gradually adjusted upwards until the optimum settings per application are found.
Questions? Contact us by telephone at (800) 776-6170.

Series # 6513

Material group	Hardness	SFM	Feed Rate - IPR									
			1/16 in. 1.590 mm	1/8 in. 3.170 mm	1/4 in. 6.350 mm	3/8 in. 9.520 mm	1/2 in. 12.700 mm	5/8 in. 15.870 mm	3/4 in. 19.050 mm	1 in. 25.400 mm	1 1/4 in. 31.750 mm	1 1/2 in. 38.100 mm
Common structural steels	≤100 Bhn	260	0.003	0.005	0.008	0.012	0.012	0.016				
	>100-260 Bhn	260	0.003	0.005	0.008	0.012	0.012	0.016				
Free-cutting steels	≤24 Rc	360	0.004	0.006	0.010	0.015	0.016	0.020				
	>24-30 Rc	330	0.004	0.006	0.010	0.015	0.016	0.020				
Unalloyed heat-treatable steels	≤16 Rc	360	0.003	0.004	0.006	0.009	0.010	0.012				
	16-24 Rc	260	0.003	0.005	0.008	0.012	0.012	0.016				
	24-30 Rc	260	0.003	0.005	0.008	0.012	0.012	0.016				
Alloyed heat-treatable steels	24-30 Rc	260	0.003	0.005	0.008	0.012	0.012	0.016				
	>30-38 Rc	260	0.003	0.004	0.006	0.009	0.010	0.012				
Unalloyed case hardened steels	≤230 Bhn	260	0.003	0.005	0.008	0.012	0.012	0.016				
Alloyed case hardened steels	24-30 Rc	260	0.003	0.004	0.006	0.009	0.010	0.012				
	>30-38 Rc	260	0.003	0.004	0.006	0.009	0.010	0.012				
Nitriding steels	≥24-30 Rc	260	0.002	0.003	0.005	0.007	0.008	0.010				
	>30-38 Rc	195	0.002	0.003	0.005	0.007	0.008	0.010				
Tool steels	≤24 Rc	260	0.003	0.004	0.006	0.009	0.010	0.012				
	>24-30 Rc	230	0.002	0.002	0.004	0.006	0.006	0.008				
High speed steels	≥14-30 Rc	165	0.002	0.002	0.004	0.006	0.006	0.008				
Spring steels	≤330 Bhn	165	0.002	0.002	0.004	0.006	0.006	0.008				
Stainless steels, sulphured austenitic martensitic	≤24 Rc	260	0.002	0.003	0.005	0.007	0.008	0.010				
	≤24 Rc	230	0.001	0.002	0.003	0.005	0.005	0.006				
	≤24 Rc	260	0.002	0.003	0.005	0.007	0.008	0.010				
Hardened steels	≤40-48 Rc	165	0.002	0.002	0.004	0.006	0.006	0.008				
	>48-60 Rc	165	0.002	0.002	0.004	0.006	0.006	0.008				
Special alloys	≤38 Rc	100	0.001	0.002	0.002	0.004	0.004	0.005				
Cast iron	≤240 Bhn	395	0.004	0.006	0.010	0.015	0.016	0.020				
	<300 Bhn	260	0.004	0.006	0.010	0.015	0.016	0.020				
Spheroidal graphite iron and malleable cast iron	≤240 Bhn	395	0.004	0.006	0.010	0.015	0.016	0.020				
	<300 Bhn	260	0.004	0.006	0.010	0.015	0.016	0.020				
Chilled cast iron	≤350 Bhn		*	*	*	*	*	*				
Ti and Ti-alloys	≤24 Rc		*	*	*	*	*	*				
	>24-38 Rc		*	*	*	*	*	*				
Aluminium and Al-alloys	≤120 Bhn		*	*	*	*	*	*				
Al wrought alloys	≤150 Bhn		*	*	*	*	*	*				
Al cast alloys ≤ 10 % Si	≤200 Bhn		*	*	*	*	*	*				
	> 10 % Si		*	*	*	*	*	*				
Magnesium alloys	≤150 Bhn		*	*	*	*	*	*				
Copper, low-alloyed	≤120 Bhn	395	0.001	0.001	0.002	0.004	0.003	0.004				
Brass, short-chipping long-chipping	≤200 Bhn	330	0.004	0.006	0.010	0.015	0.016	0.020				
	≤200 Bhn											
Bronze, short-chipping	≤200 Bhn											
	>200-260 Bhn											
Bronze, long-chipping	≤24 Rc											
	>24-30 Rc											
Note: Pilot holes (depth >1xD) are recommended when using RT100T drills. Use a series 5514 or similar drill to drill a minimum of 1xD deep. Then enter the pilot hole with the RT100T drill at approx 300 rev/min and 500 mm/min speed, start high coolant pressure and increase RPM. Drill to hole depth without pecking.												
Duroplastics	-											
Thermoplastics	-											
Reinforced plastics - Kevlar	-											
Reinforced plastics - GFK / CFK	-											

Series # 6514

Material group	Hardness	SFM	Feed Rate - IPR									
			1/16 in. 1.590 mm	1/8 in. 3.170 mm	1/4 in. 6.350 mm	3/8 in. 9.520 mm	1/2 in. 12.700 mm	5/8 in. 15.870 mm	3/4 in. 19.050 mm	1 in. 25.400 mm	1 1/4 in. 31.750 mm	1 1/2 in. 38.100 mm
Common structural steels	≤100 Bhn	260	0.003	0.005	0.008	0.012	0.012	0.016				
	>100-260 Bhn	260	0.003	0.005	0.008	0.012	0.012	0.016				
Free-cutting steels	≤24 Rc	330	0.004	0.006	0.010	0.015	0.016	0.020				
	>24-30 Rc	330	0.004	0.006	0.010	0.015	0.016	0.020				
Unalloyed heat-treatable steels	≤16 Rc	360	0.003	0.004	0.006	0.009	0.010	0.012				
	16-24 Rc	260	0.003	0.005	0.008	0.012	0.012	0.016				
	24-30 Rc	260	0.003	0.005	0.008	0.012	0.012	0.016				
Alloyed heat-treatable steels	24-30 Rc	260	0.003	0.005	0.008	0.012	0.012	0.016				
	>30-38 Rc	260	0.003	0.004	0.006	0.009	0.010	0.012				
Unalloyed case hardened steels	≤230 Bhn	260	0.003	0.005	0.008	0.012	0.012	0.016				
Alloyed case hardened steels	24-30 Rc	260	0.003	0.004	0.006	0.009	0.010	0.012				
	>30-38 Rc	260	0.003	0.004	0.006	0.009	0.010	0.012				
Nitriding steels	≥24-30 Rc	260	0.002	0.003	0.005	0.007	0.008	0.010				
	>30-38 Rc	195	0.002	0.003	0.005	0.007	0.008	0.010				
Tool steels	≤24 Rc	260	0.003	0.004	0.006	0.009	0.010	0.012				
	>24-30 Rc	230	0.002	0.002	0.004	0.006	0.006	0.008				
High speed steels	≥14-30 Rc	165	0.002	0.002	0.004	0.006	0.006	0.008				
Spring steels	≤330 Bhn	165	0.002	0.002	0.004	0.006	0.006	0.008				
Stainless steels, sulphured austenitic martensitic	≤24 Rc	260	0.002	0.003	0.005	0.007	0.008	0.010				
	≤24 Rc	230	0.001	0.002	0.003	0.005	0.005	0.006				
	≤24 Rc	260	0.002	0.003	0.005	0.007	0.008	0.010				
Hardened steels	≤40-48 Rc	165	0.002	0.002	0.004	0.006	0.006	0.008				
	>48-60 Rc	165	0.002	0.002	0.004	0.006	0.006	0.008				
Special alloys	≤38 Rc	100	0.001	0.002	0.002	0.004	0.004	0.005				
Cast iron	≤240 Bhn	395	0.004	0.006	0.010	0.015	0.016	0.020				
	<300 Bhn	260	0.004	0.006	0.010	0.015	0.016	0.020				
Spheroidal graphite iron and malleable cast iron	≤240 Bhn	395	0.004	0.006	0.010	0.015	0.016	0.020				
	<300 Bhn	260	0.004	0.006	0.010	0.015	0.016	0.020				
Chilled cast iron	≤350 Bhn		*	*	*	*	*	*				
Ti and Ti-alloys	≤24 Rc		*	*	*	*	*	*				
	>24-38 Rc		*	*	*	*	*	*				
Aluminium and Al-alloys	≤120 Bhn		*	*	*	*	*	*				
Al wrought alloys	≤150 Bhn		*	*	*	*	*	*				
Al cast alloys ≤ 10 % Si	≤200 Bhn		*	*	*	*	*	*				
	> 10 % Si		*	*	*	*	*	*				
Magnesium alloys	≤150 Bhn		*	*	*	*	*	*				
Copper, low-alloyed	≤120 Bhn	395	0.001	0.001	0.002	0.004	0.003	0.004				
Brass, short-chipping long-chipping	≤200 Bhn	330	0.004	0.006	0.010	0.015	0.016	0.020				
	≤200 Bhn											
Bronze, short-chipping	≤200 Bhn											
	>200-260 Bhn											
Bronze, long-chipping	≤24 Rc											
	>24-30 Rc											
Note: Pilot holes (depth >1xD) are recommended when using RT100T drills. Use a series 5514 or similar drill to drill a minimum of 1xD deep. Then enter the pilot hole with the RT100T drill at approx 300 rev/min and 500 mm/min speed, start high coolant pressure and increase RPM. Drill to hole depth without pecking.												
Duroplastics	-											
Thermoplastics	-											
Reinforced plastics - Kevlar	-											
Reinforced plastics - GFK / CFK	-											

$$\text{RPM} = \frac{\text{SFM}}{\text{DIAM. in.}} \times 3.82 \quad \text{IPM} = \text{IPR} \times \text{RPM}$$

$$\text{HOLE DEPTH in.} \div \text{IPM} \times 60 = \text{Cut Time}$$

$$\text{mm} = \text{in.} \times 25.40$$

$$\text{m/min.} = \text{SFM} \div 3.28$$

$$\text{mm/rev.} = \text{IPR} \times 25.40 \quad \text{Bar} = \text{PSI} \div 14.50$$

$$\text{Liter} = \text{Gal.} \div 3.79$$

Series # 8510

Material group	Hardness	SFM	Feed Rate - IPR																
			1/16 in. 1.590 mm	1/8 in. 3.170 mm	1/4 in. 6.350 mm	3/8 in. 9.520 mm	1/2 in. 12.700 mm	5/8 in. 15.870 mm	3/4 in. 19.050 mm	1 in. 25.400 mm	1 1/4 in. 31.750 mm	1 1/2 in. 38.100 mm							
Common structural steels	≤100 Bhn	475	•	•	•	•	•	•	•	•	•	•	•	•	•	•	•	•	
	>100-260 Bhn	395	•	•	•	•	•	•	•	•	•	•	•	•	•	•	•	•	•
Free-cutting steels	≤24 Rc	560	•	•	•	•	•	•	•	•	•	•	•	•	•	•	•	•	•
	>24-30 Rc	475	•	•	•	•	•	•	•	•	•	•	•	•	•	•	•	•	•
Unalloyed heat-treatable steels	≤16 Rc	425	•	•	•	•	•	•	•	•	•	•	•	•	•	•	•	•	•
	16-24 Rc	410	•	•	•	•	•	•	•	•	•	•	•	•	•	•	•	•	•
	24-30 Rc	395	•	•	•	•	•	•	•	•	•	•	•	•	•	•	•	•	•
Alloyed heat-treatable steels	24-30 Rc	395	•	•	•	•	•	•	•	•	•	•	•	•	•	•	•	•	•
	>30-38 Rc	345	•	•	•	•	•	•	•	•	•	•	•	•	•	•	•	•	•
Unalloyed case hardened steels	≤230 Bhn	475	•	•	•	•	•	•	•	•	•	•	•	•	•	•	•	•	•
Alloyed case hardened steels	24-30 Rc	395	•	•	•	•	•	•	•	•	•	•	•	•	•	•	•	•	•
	>30-38 Rc	280	•	•	•	•	•	•	•	•	•	•	•	•	•	•	•	•	•
Nitriding steels	≥24-30 Rc	360	•	•	•	•	•	•	•	•	•	•	•	•	•	•	•	•	•
	>30-38 Rc	345	•	•	•	•	•	•	•	•	•	•	•	•	•	•	•	•	•
Tool steels	≤24 Rc	260	•	•	•	•	•	•	•	•	•	•	•	•	•	•	•	•	•
	>24-30 Rc	215	•	•	•	•	•	•	•	•	•	•	•	•	•	•	•	•	•
High speed steels	≥14-30 Rc	195	•	•	•	•	•	•	•	•	•	•	•	•	•	•	•	•	•
Spring steels	≤330 Bhn	195	•	•	•	•	•	•	•	•	•	•	•	•	•	•	•	•	•
Stainless steels, sulphured austenitic martensitic	≤24 Rc	195	•	•	•	•	•	•	•	•	•	•	•	•	•	•	•	•	•
	≤24 Rc	180	•	•	•	•	•	•	•	•	•	•	•	•	•	•	•	•	•
	≤24 Rc	165	•	•	•	•	•	•	•	•	•	•	•	•	•	•	•	•	•
Hardened steels	≤40-48 Rc	180	•	•	•	•	•	•	•	•	•	•	•	•	•	•	•	•	•
	>48-60 Rc	115	•	•	•	•	•	•	•	•	•	•	•	•	•	•	•	•	•
Special alloys	≤38 Rc	115	•	•	•	•	•	•	•	•	•	•	•	•	•	•	•	•	•
Cast iron	≤240 Bhn	690	•	•	•	•	•	•	•	•	•	•	•	•	•	•	•	•	•
	<300 Bhn	525	•	•	•	•	•	•	•	•	•	•	•	•	•	•	•	•	•
Spheroidal graphite iron and malleable cast iron	≤240 Bhn	460	•	•	•	•	•	•	•	•	•	•	•	•	•	•	•	•	•
	<300 Bhn	425	•	•	•	•	•	•	•	•	•	•	•	•	•	•	•	•	•
Chilled cast iron	≤350 Bhn	130	•	•	•	•	•	•	•	•	•	•	•	•	•	•	•	•	•
Ti and Ti-alloys	≤24 Rc	150	•	•	•	•	•	•	•	•	•	•	•	•	•	•	•	•	•
	>24-38 Rc	130	•	•	•	•	•	•	•	•	•	•	•	•	•	•	•	•	•
Aluminium and Al-alloys	≤120 Bhn	1015	•	•	•	•	•	•	•	•	•	•	•	•	•	•	•	•	•
	Al wrought alloys	≤150 Bhn	1015	•	•	•	•	•	•	•	•	•	•	•	•	•	•	•	•
Al cast alloys ≤ 10 % Si > 10 % Si	≤200 Bhn	855	•	•	•	•	•	•	•	•	•	•	•	•	•	•	•	•	•
	≤200 Bhn	720	•	•	•	•	•	•	•	•	•	•	•	•	•	•	•	•	•
Magnesium alloys	≤150 Bhn	920	•	•	•	•	•	•	•	•	•	•	•	•	•	•	•	•	•
Copper, low-alloyed	≤120 Bhn	410	•	•	•	•	•	•	•	•	•	•	•	•	•	•	•	•	•
Brass, short-chipping long-chipping	≤200 Bhn	1065	•	•	•	•	•	•	•	•	•	•	•	•	•	•	•	•	•
	≤200 Bhn	720	•	•	•	•	•	•	•	•	•	•	•	•	•	•	•	•	•
Bronze, short-chipping	≤200 Bhn	410	•	•	•	•	•	•	•	•	•	•	•	•	•	•	•	•	•
	>200-260 Bhn	345	•	•	•	•	•	•	•	•	•	•	•	•	•	•	•	•	•
Bronze, long-chipping	≤24 Rc	295	•	•	•	•	•	•	•	•	•	•	•	•	•	•	•	•	•
	>24-30 Rc	260	•	•	•	•	•	•	•	•	•	•	•	•	•	•	•	•	•
Duroplastics	-	•	•	•	•	•	•	•	•	•	•	•	•	•	•	•	•	•	•
Thermoplastics	-	•	•	•	•	•	•	•	•	•	•	•	•	•	•	•	•	•	•
Reinforced plastics - Kevlar	-	•	•	•	•	•	•	•	•	•	•	•	•	•	•	•	•	•	•
Reinforced plastics - GFK / CFK	-	•	•	•	•	•	•	•	•	•	•	•	•	•	•	•	•	•	•

Series # 8511

Material group	Hardness	SFM	Feed Rate - IPR																	
			1/16 in. 1.590 mm	1/8 in. 3.170 mm	1/4 in. 6.350 mm	3/8 in. 9.520 mm	1/2 in. 12.700 mm	5/8 in. 15.870 mm	3/4 in. 19.050 mm	1 in. 25.400 mm	1 1/4 in. 31.750 mm	1 1/2 in. 38.100 mm								
Common structural steels	≤100 Bhn	475	•	•	•	•	•	•	•	•	•	•	•	•	•	•	•	•	•	•
	>100-260 Bhn	395	•	•	•	•	•	•	•	•	•	•	•	•	•	•	•	•	•	•
Free-cutting steels	≤24 Rc	560	•	•	•	•	•	•	•	•	•	•	•	•	•	•	•	•	•	•
	>24-30 Rc	475	•	•	•	•	•	•	•	•	•	•	•	•	•	•	•	•	•	•
Unalloyed heat-treatable steels	≤16 Rc	425	•	•	•	•	•	•	•	•	•	•	•	•	•	•	•	•	•	•
	16-24 Rc	410	•	•	•	•	•	•	•	•	•	•	•	•	•	•	•	•	•	•
	24-30 Rc	395	•	•	•	•	•	•	•	•	•	•	•	•	•	•	•	•	•	•
Alloyed heat-treatable steels	24-30 Rc	395	•	•	•	•	•	•	•	•	•	•	•	•	•	•	•	•	•	•
	>30-38 Rc	345	•	•	•	•	•	•	•	•	•	•	•	•	•	•	•	•	•	•
Unalloyed case hardened steels	≤230 Bhn	475	•	•	•	•	•	•	•	•	•	•	•	•	•	•	•	•	•	•
Alloyed case hardened steels	24-30 Rc	395	•	•	•	•	•	•	•	•	•	•	•	•	•	•	•	•	•	•
	>30-38 Rc	280	•	•	•	•	•	•	•	•	•	•	•	•	•	•	•	•	•	•
Nitriding steels	≥24-30 Rc	350	•	•	•	•	•	•	•	•	•	•	•	•	•	•	•	•	•	•
	>30-38 Rc	330	•	•	•	•	•	•	•	•	•	•	•	•	•	•	•	•	•	•
Tool steels	≤24 Rc	240	•	•	•	•	•	•	•	•	•	•	•	•	•	•	•	•	•	•
	>24-30 Rc	180	•	•	•	•	•	•	•	•	•	•	•	•	•	•	•	•	•	•
High speed steels	≥14-30 Rc	195	•	•	•	•	•	•	•	•	•	•	•	•	•	•	•	•	•	•
Spring steels	≤330 Bhn	195	•	•	•	•	•	•	•	•	•	•	•	•	•	•	•	•	•	•
Stainless steels, sulphured austenitic martensitic	≤24 Rc	195	•	•	•	•	•	•	•	•	•	•	•	•	•	•	•	•	•	•
	≤24 Rc	180	•	•	•	•	•	•	•	•	•	•	•	•	•	•	•	•	•	•
	≤24 Rc	165	•	•	•	•	•	•	•	•	•	•	•	•	•	•	•	•	•	•
Hardened steels	≤40-48 Rc	180	•	•	•	•	•	•	•	•	•	•	•	•	•	•	•	•	•	•
	>48-60 Rc	115	•	•	•	•	•	•	•	•	•	•	•	•	•	•	•	•	•	•
Special alloys	≤38 Rc	115	•	•	•	•	•	•	•	•	•	•	•	•	•	•	•	•	•	•
Cast iron	≤240 Bhn	690	•	•	•	•														

Series # 8520

Material group	Hardness	SFM	Feed Rate - IPR									
			1/16 in. 1.590 mm	1/8 in. 3.170 mm	1/4 in. 6.350 mm	3/8 in. 9.520 mm	1/2 in. 12.700 mm	5/8 in. 15.870 mm	3/4 in. 19.050 mm	1 in. 24.400 mm	1 1/4 in. 31.750 mm	1 1/2 in. 38.100 mm
Common structural steels	≤100 Bhn 260 Bhn	475 395	0.0028 0.0016	0.0050 0.0039	0.0080 0.0063	0.0120 0.0098	0.0120 0.0098	0.0160 0.0124	0.0200 0.0157	0.0250 0.0197	•	•
Free-cutting steels	≤24 Rc >24-30 Rc	560 475	0.0011 0.0011	0.0063 0.0063	0.0098 0.0098	0.0150 0.0150	0.0157 0.0157	0.0197 0.0197	0.0248 0.0248	0.0315 0.0315	•	•
Unalloyed heat-treatable steels	≤16 Rc 16-24 Rc 24-30 Rc	425 410 395	0.0011 0.0028 0.0028	0.0063 0.0049 0.0049	0.0098 0.0079 0.0079	0.0150 0.0124 0.0124	0.0157 0.0124 0.0124	0.0197 0.0157 0.0157	0.0248 0.0197 0.0197	0.0315 0.0248 0.0248	•	•
Alloyed heat-treatable steels	24-30 Rc >30-38 Rc	395 345	0.0028 0.0028	0.0049 0.0049	0.0079 0.0079	0.0124 0.0124	0.0124 0.0124	0.0157 0.0157	0.0197 0.0197	0.0248 0.0248	•	•
Unalloyed case hardened steels	≤230 Bhn	475	0.0011	0.0063	0.0098	0.0150	0.0157	0.0197	0.0248	0.0315	•	•
Alloyed case hardened steels	24-30 Rc >30-38 Rc	395 280	0.0028 0.0007	0.0049 0.0031	0.0079 0.0049	0.0124 0.0075	0.0124 0.0079	0.0157 0.0098	0.0197 0.0124	0.0248 0.0157	•	•
Nitriding steels	≥24-30 Rc >30-38 Rc	360 345	0.0028 0.0007	0.0049 0.0031	0.0079 0.0049	0.0124 0.0075	0.0124 0.0079	0.0157 0.0098	0.0197 0.0124	0.0248 0.0157	•	•
Tool steels	≤24 Rc >24-30 Rc	260 215	0.0016 0.0007	0.0039 0.0031	0.0063 0.0049	0.0098 0.0075	0.0098 0.0075	0.0124 0.0098	0.0157 0.0124	0.0197 0.0157	•	•
High speed steels	≥14-30 Rc	195	0.0007	0.0025	0.0039	0.0059	0.0063	0.0079	0.0098	0.0124	•	•
Spring steels	≤330 Bhn	195	0.0008	0.0020	0.0031	0.0049	0.0049	0.0063	0.0079	0.0098	•	•
Stainless steels, sulphured austenitic martensitic	≤24 Rc ≤24 Rc ≤24 Rc	• • •	• • •	• • •	• • •	• • •	• • •	• • •	• • •	• • •	• • •	• • •
Hardened steels	≤40-48 Rc >48-60 Rc	180 115	0.0008 0.0004	0.0020 0.0016	0.0031 0.0025	0.0049 0.0039	•	0.0063 0.0049	0.0079 0.0063	0.0098 0.0079	•	•
Special alloys	≤38 Rc	115	0.0007	0.0025	0.0039	0.0059	•	0.0079	0.0098	0.0124	•	•
Cast iron	≤240 Bhn <300 Bhn	• •	• •	• •	• •	• •	• •	• •	• •	• •	• •	• •
Spheroidal graphite iron and malleable cast iron	≤240 Bhn <300 Bhn	• •	• •	• •	• •	• •	• •	• •	• •	• •	• •	• •
Chilled cast iron	≤350 Bhn	•	•	•	•	•	•	•	•	•	•	•
Ti and Ti-alloys	≤24 Rc >24-38 Rc	150 130	0.0007 0.0008	0.0025 0.0020	0.0039 0.0031	0.0059 0.0049	•	0.0049 0.0063	0.0098 0.0079	0.0124 0.0098	•	•
Aluminium and Al-alloys	≤120 Bhn	•	•	•	•	•	•	•	•	•	•	•
Al wrought alloys	≤150 Bhn	•	•	•	•	•	•	•	•	•	•	•
Al cast alloys ≤ 10 % Si	≤200 Bhn	•	•	•	•	•	•	•	•	•	•	•
> 10 % Si	≤200 Bhn	•	•	•	•	•	•	•	•	•	•	•
Magnesium alloys	≤150 Bhn	•	•	•	•	•	•	•	•	•	•	•
Copper, low-alloyed	≤120 Bhn	•	•	•	•	•	•	•	•	•	•	•
Brass, short-chipping	≤200 Bhn	•	•	•	•	•	•	•	•	•	•	•
long-chipping	≤200 Bhn	•	•	•	•	•	•	•	•	•	•	•
Bronze, short-chipping	≤200 Bhn	•	•	•	•	•	•	•	•	•	•	•
Bronze, long-chipping	>200 Bhn	•	•	•	•	•	•	•	•	•	•	•
Duroplastics	-	•	•	•	•	•	•	•	•	•	•	•
Thermoplastics	-	•	•	•	•	•	•	•	•	•	•	•
Reinforced plastics - Kevlar	-	•	•	•	•	•	•	•	•	•	•	•
Reinforced plastics - GFK / CFK	-	•	•	•	•	•	•	•	•	•	•	•

Series # 8521

Material group	Hardness	SFM	Feed Rate - IPR									
			1/16 in. 1.590 mm	1/8 in. 3.170 mm	1/4 in. 6.350 mm	3/8 in. 9.520 mm	1/2 in. 12.700 mm	5/8 in. 15.870 mm	3/4 in. 19.050 mm	1 in. 24.400 mm	1 1/4 in. 31.750 mm	1 1/2 in. 38.100 mm
Common structural steels	≤100 Bhn 260 Bhn	475 395	0.0028 0.0016	0.0050 0.0039	0.0080 0.0063	0.0120 0.0098	0.0120 0.0098	0.0160 0.0124	0.0200 0.0157	0.0250 0.0197	•	•
Free-cutting steels	≤24 Rc >24-30 Rc	560 475	0.0011 0.0011	0.0063 0.0063	0.0098 0.0098	0.0150 0.0150	0.0157 0.0157	0.0197 0.0197	0.0248 0.0248	0.0315 0.0315	•	•
Unalloyed heat-treatable steels	≤16 Rc 16-24 Rc 24-30 Rc	425 410 395	0.0011 0.0028 0.0028	0.0063 0.0049 0.0049	0.0098 0.0079 0.0079	0.0150 0.0124 0.0124	0.0157 0.0124 0.0124	0.0197 0.0157 0.0157	0.0248 0.0197 0.0197	0.0315 0.0248 0.0248	•	•
Alloyed heat-treatable steels	24-30 Rc >30-38 Rc	395 345	0.0028 0.0028	0.0049 0.0049	0.0079 0.0079	0.0124 0.0124	0.0124 0.0124	0.0157 0.0157	0.0197 0.0197	0.0248 0.0248	•	•
Unalloyed case hardened steels	≤230 Bhn	475	0.0011	0.0063	0.0098	0.0150	0.0157	0.0197	0.0248	0.0315	•	•
Alloyed case hardened steels	24-30 Rc >30-38 Rc	395 280	0.0028 0.0007	0.0049 0.0031	0.0079 0.0049	0.0124 0.0075	0.0124 0.0079	0.0157 0.0098	0.0197 0.0124	0.0248 0.0157	•	•
Nitriding steels	≥24-30 Rc >30-38 Rc	360 345	0.0028 0.0007	0.0049 0.0031	0.0079 0.0049	0.0124 0.0075	0.0124 0.0079	0.0157 0.0098	0.0197 0.0124	0.0248 0.0157	•	•
Tool steels	≤24 Rc >24-30 Rc	260 215	0.0016 0.0007	0.0039 0.0031	0.0063 0.0049	0.0098 0.0075	0.0098 0.0075	0.0124 0.0098	0.0157 0.0124	0.0197 0.0157	•	•
High speed steels	≥14-30 Rc	195	0.0007	0.0025	0.0039	0.0059	0.0063	0.0079	0.0098	0.0124	•	•
Spring steels	≤330 Bhn	195	0.0008	0.0020	0.0031	0.0049	0.0049	0.0063	0.0079	0.0098	•	•
Stainless steels, sulphured austenitic martensitic	≤24 Rc ≤24 Rc ≤24 Rc	• • •	• • •	• • •	• • •	• • •	• • •	• • •	• • •	• • •	• • •	• • •
Hardened steels	≤40-48 Rc >48-60 Rc	180 115	0.0008 0.0004	0.0020 0.0016	0.0031 0.0025	0.0049 0.0039	•	0.0063 0.0049	0.0079 0.0063	0.0098 0.0079	•	•
Special alloys	≤38 Rc	115	0.0007	0.0025	0.0039	0.0059	•	0.0079	0.0098	0.0124	•	•
Cast iron	≤240 Bhn <300 Bhn	• •	• •	• •	• •	• •	• •	• •	• •	• •	• •	• •
Spheroidal graphite iron and malleable cast iron	≤240 Bhn <300 Bhn	• •	• •	• •	• •	• •	• •	• •	• •	• •	• •	• •
Chilled cast iron	≤350 Bhn	•	•	•	•	•	•	•	•	•	•	•
Ti and Ti-alloys	≤24 Rc >24-38 Rc	150 130	0.0007 0.0008	0.0025 0.0020	0.0039 0.0031	0.0059 0.0049	•	0.0049 0.0063	0.0098 0.0079	0.0124 0.0098	•	•
Aluminium and Al-alloys	≤120 Bhn	•	•	•	•	•	•	•	•	•	•	•
Al wrought alloys	≤150 Bhn	•	•	•	•	•	•	•	•	•	•	•
Al cast alloys ≤ 10 % Si	≤200 Bhn	•	•	•	•	•	•	•	•	•	•	•
> 10 % Si	≤200 Bhn	•	•	•	•	•	•	•	•	•	•	•
Magnesium alloys	≤150 Bhn	•	•	•	•	•	•	•	•	•	•	•
Copper, low-alloyed	≤120 Bhn	•	•	•	•	•	•	•	•	•	•	•
Brass, short-chipping	≤200 Bhn	•	•	•	•	•	•	•	•	•	•	•
long-chipping	≤200 Bhn	•	•	•	•	•	•	•	•	•	•	•
Bronze, short-chipping	≤200 Bhn	•	•	•	•	•	•	•	•	•	•	•
Bronze, long-chipping	>200 Bhn	•	•	•	•	•	•	•	•	•	•	•
Duroplastics	-	•	•	•	•	•	•	•	•	•	•	•
Thermoplastics	-	•	•	•	•	•	•	•	•	•	•	•
Reinforced plastics - Kevlar	-	•	•	•	•	•	•	•	•	•	•	•
Reinforced plastics - GFK / CFK	-	•	•	•	•	•	•	•	•	•	•	•

Series # 8522

Material group	Hardness	SFM	Feed Rate - IPR										
			1/16 in. 1.590 mm	1/8 in. 3.170 mm	1/4 in. 6.350 mm	3/8 in. 9.520 mm	1/2 in. 12.700 mm	5/8 in. 15.870 mm	3/4 in. 19.050 mm	1 in. 24.400 mm	1 1/4 in. 31.750 mm	1 1/2 in. 38.100 mm	
Common structural steels	≤100 Bhn 260 Bhn	475 395	0.0160 0.0007	0.0040 0.0031	0.0060 0.0049	0.0100 0.0075	0.0100 0.0079	0.0120 0.0098	0.0160 0.0124	0.0200 0.0157	•	•	
Free-cutting steels	≤24 Rc >24-30 Rc	560 475	0.0028 0.0028	0.0049 0.0049	0.0079 0.0079	0.0124 0.0124	0.0124 0.0124	0.0157 0.0157	0.0197 0.0197	0.0248 0.0248	•	•	
Unalloyed heat-treatable steels	≤16 Rc 16-24 Rc 24-30 Rc	425 410 395	0.0028 0.0016 0.0016	0.0049 0.0039 0.0039	0.0079 0.0063 0.0063	0.0124 0.0098 0.0098	0.0124 0.0098 0.0098	0.0157 0.0124 0.0124	0.0197 0.0157 0.0157	0.0248 0.0197 0.0197	•	•	
Alloyed heat-treatable steels	24-30 Rc >30-38 Rc	395 345	0.0016 0.0016	0.0039 0.0039	0.0063 0.0063	0.0098 0.0098	0.0098 0.0098	0.0124 0.0124	0.0157 0.0157	0.0197 0.0197	•	•	
Unalloyed case hardened steels	≤230 Bhn	475	0.0028	0.0049	0.0079	0.0124	0.0124	0.0157	0.0197	0.0248	•	•	
Alloyed case hardened steels	24-30 Rc >30-38 Rc	395 280	0.0016 0.0007	0.0039 0.0025	0.0063 0.0039	0.0098 0.0059	0.0098 0.0063	0.0124 0.0079	0.0157 0.0098	0.0197 0.0124	•	•	
Nitriding steels	≥24-30 Rc >30-38 Rc	360 345	0.0016 0.0007	0.0039 0.0025	0.0063 0.0039	0.0098 0.0059	0.0098 0.0063	0.0124 0.0079	0.0157 0.0098	0.0197 0.0124	•	•	
Tool steels	≤24 Rc >24-30 Rc	260 215	0.0007 0.0007	0.0031 0.0025	0.0049 0.0039	0.0075 0.0059	0.0079 0.0063	0.0098 0.0079	0.0124 0.0098	0.0157 0.0124	•	•	
High speed steels	≥14-30 Rc	195	0.0008	0.0020	0.0031	0.0049	0.0049	0.0063	0.0079	0.0098	•	•	
Spring steels	≤330 Bhn	195	0.0004	0.0016	0.0025	0.0039	0.0039	0.0049	0.0063	0.0079	•	•	
Stainless steels, sulphured austenitic martensitic	≤24 Rc ≤24 Rc ≤24 Rc	• • •	• • •	• • •	• • •	• • •	• • •	• • •	• • •	• • •	• • •	• • •	
Hardened steels	≤40-48 Rc >48-60 Rc	180 115	0.0004 0.0007	0.0016 0.0013	0.0025 0.0020	0.0039 0.0031	0.0039 0.0031	0.0049 0.0039	0.0063 0.0049	0.0079 0.0063	•	•	
Special alloys	≤38 Rc	115	0.0008	0.0020	0.0031	0.0049	0.0049	0.0063	0.0079	0.0098	•	•	
Cast iron	≤240 Bhn <300 Bhn	• •	• •	• •	• •	• •	• •	• •	• •	• •	• •	• •	
Spheroidal graphite iron and malleable cast iron	≤240 Bhn <300 Bhn	• •	• •	• •	• •	• •	• •	• •	• •	• •	• •	• •	
Chilled cast iron	≤350 Bhn	•	•	•	•	•	•	•	•	•	•	•	
Ti and Ti-alloys	≤24 Rc >24-38 Rc	150 130	0.0008 0.0008	0.0020 0.0020	0.0031 0.0031	0.0049 0.0049	0.0049 0.0049	0.0063 0.0063	0.0079 0.0079	0.0098 0.0098	•	•	
Aluminium and Al-alloys	≤120 Bhn	•	•	•	•	•	•	•	•	•	•	•	
Al wrought alloys	≤150 Bhn	•	•	•	•	•	•	•	•	•	•	•	
Al cast alloys ≤ 10 % Si > 10 % Si	≤200 Bhn ≤200 Bhn	• •	• •	• •	• •	• •	• •	• •	• •	• •	• •	• •	
Magnesium alloys	≤150 Bhn	•	•	•	•	•	•	•	•	•	•	•	
Copper, low-alloyed	≤120 Bhn	•	•	•	•	•	•	•	•	•	•	•	
Brass, short-chipping long-chipping	≤200 Bhn ≤200 Bhn	• •	• •	• •	• •	• •	• •	• •	• •	• •	• •	• •	
Bronze, short-chipping	≤200 Bhn	•	•	•	•	•	•	•	•	•	•	•	
Bronze, long-chipping	>200 Bhn	•	•	•	•	•	•	•	•	•	•	•	
Duroplastics	-	•	•	•	•	•	•	•	•	•	•	•	
Thermoplastics	-	•	•	•	•	•	•	•	•	•	•	•	
Reinforced plastics - Kevlar	-	•	•	•	•	•	•	•	•	•	•	•	
Reinforced plastics - GFK / CFK	-	•	•	•	•	•	•	•	•	•	•	•	

Series # 8524

Material group	Hardness	SFM	Feed Rate - IPR										
			1/16 in. 1.590 mm	1/8 in. 3.170 mm	1/4 in. 6.350 mm	3/8 in. 9.520 mm	1/2 in. 12.700 mm	5/8 in. 15.870 mm	3/4 in. 19.050 mm	1 in. 24.400 mm	1 1/4 in. 31.750 mm	1 1/2 in. 38.100 mm	
Common structural steels	≤100 Bhn 260 Bhn	425 360	0.0028 0.0016	0.0050 0.0039	0.0080 0.0063	0.0120 0.0098	0.0120 0.0098	0.0160 0.0124	0.0200 0.0157	0.0250 0.0197	•	•	
Free-cutting steels	≤24 Rc >24-30 Rc	475 360	0.0011 0.0031	0.0063 0.0049	0.0098 0.0079	0.0150 0.0124	0.0157 0.0124	0.0197 0.0157	0.0248 0.0197	0.0315 0.0248	•	•	
Unalloyed heat-treatable steels	≤16 Rc 16-24 Rc 24-30 Rc	395 360 345	0.0031 0.0028 0.0028	0.0049 0.0049 0.0049	0.0079 0.0079 0.0079	0.0124 0.0124 0.0124	0.0124 0.0214 0.0214	0.0157 0.0157 0.0157	0.0197 0.0197 0.0197	0.0248 0.0248 0.0248	•	•	
Alloyed heat-treatable steels	24-30 Rc >30-38 Rc	345 330	0.0028 0.0025	0.0049 0.0039	0.0079 0.0063	0.0124 0.0098	0.0124 0.0098	0.0157 0.0124	0.0197 0.0157	0.0248 0.0197	•	•	
Unalloyed case hardened steels	≤230 Bhn	425	0.0011	0.0063	0.0098	0.0150	0.0157	0.0124	0.0248	0.0315	•	•	
Alloyed case hardened steels	24-30 Rc >30-38 Rc	395 280	0.0028 0.0007	0.0049 0.0031	0.0079 0.0049	0.0124 0.0075	0.0124 0.0079	0.0157 0.0098	0.0197 0.0124	0.0248 0.0157	•	•	
Nitriding steels	≥24-30 Rc >30-38 Rc	330 295	0.0025 0.0007	0.0039 0.0031	0.0063 0.0049	0.0098 0.0075	0.0098 0.0079	0.0124 0.0098	0.0157 0.0124	0.0197 0.0157	•	•	
Tool steels	≤24 Rc >24-30 Rc	215 180	0.0016 0.0007	0.0039 0.0031	0.0063 0.0049	0.0098 0.0075	0.0098 0.0079	0.0124 0.0098	0.0157 0.0124	0.0197 0.0157	•	•	
High speed steels	≥14-30 Rc	180	0.0007	0.0025	0.0039	0.0059	0.0063	0.0079	0.0098	0.0124	•	•	
Spring steels	≤330 Bhn	150	0.0008	0.0020	0.0031	0.0049	0.0049	0.0063	0.0079	0.0098	•	•	
Stainless steels, sulphured austenitic martensitic	≤24 Rc ≤24 Rc ≤24 Rc	• • •	• • •	• • •	• • •	• • •	• • •	• • •	• • •	• • •	• • •	• • •	
Hardened steels	≤40-48 Rc >48-60 Rc	150 80	0.0008 0.0004	0.0020 0.0016	0.0031 0.0025	0.0049 0.0039	0.0049 0.0039	0.0063 0.0049	0.0079 0.0063	0.0098 0.0079	•	•	
Special alloys	≤38 Rc	80	0.0007	0.0025	0.0039	0.0059	0.0063	0.0079	0.0098	0.0124	•	•	
Cast iron	≤240 Bhn <300 Bhn	• •	• •	• •	• •	• •	• •	• •	• •	• •	• •	• •	
Spheroidal graphite iron and malleable cast iron	≤240 Bhn <300 Bhn	• •	• •	• •	• •	• •	• •	• •	• •	• •	• •	• •	
Chilled cast iron	≤350 Bhn	•	•	•	•	•	•	•	•	•	•	•	
Ti and Ti-alloys	≤24 Rc >24-38 Rc	130 115	0.0013 0.0008	0.0020 0.0020	0.0031 0.0031	0.0049 0.0049	0.0049 0.0049	0.0063 0.0063	0.0079 0.0079	0.0098 0.0098	•	•	
Aluminium and Al-alloys	≤120 Bhn	•	•	•	•	•	•	•	•	•	•	•	
Al wrought alloys	≤150 Bhn	•	•	•	•	•	•	•	•	•	•	•	
Al cast alloys ≤ 10 % Si > 10 % Si	≤200 Bhn ≤200 Bhn	• •	• •	• •	• •	• •	• •	• •	• •	• •	• •	• •	
Magnesium alloys	≤150 Bhn	•	•	•	•	•	•	•	•	•	•	•	
Copper, low-alloyed	≤120 Bhn	•	•	•	•	•	•	•	•	•	•	•	
Brass, short-chipping long-chipping	≤200 Bhn ≤200 Bhn	• •	• •	• •	• •	• •	• •	• •	• •	• •	• •	• •	
Bronze, short-chipping	≤200 Bhn	•	•	•	•	•	•	•	•	•	•	•	
Bronze, long-chipping	>200 Bhn	•	•	•	•	•	•	•	•	•	•	•	
Duroplastics	-	•	•	•	•	•	•	•	•	•	•	•	
Thermoplastics	-	•	•	•	•	•	•	•	•	•	•	•	
Reinforced plastics - Kevlar	-	•	•	•	•	•	•	•	•	•	•	•	
Reinforced plastics - GFK / CFK	-	•	•	•	•	•	•	•	•	•	•	•	



Quality Tools Need Quality Holders

GUHRING OFFERS A COMPLETE
LINE OF TOOL HOLDERS AND
CLAMPING SYSTEMS

CAT HOLDERS



CAT SHRINK FIT AND
HYDRAULIC TOOL
HOLDERS

CAT HYDRAULIC HOLDER

Product information

- balancing quality G6.3 / 15.000rev./min.
- taper according to ANSI/ASME B 5.50
- coolant through center and also through flange (plugged with threaded pins when supplied)
- axial length setting

Scope of delivery

- including setting screw, Guhring no. 4900
- including clamping key, Guhring no. 4912
- special dimensions on request



						Series Number	4216
CAT	for clamping dia. d1 in h6 inch	d ₂ mm	d ₄ mm	l ₁ mm	l ₂ mm	EDP Numbers	
40	1/4" ID (Ø 6,350)	26.0	44.5	64.0	37.0	9042161060400	
40	3/8" ID (Ø 9,520)	27.3	44.5	64.0	41.0	9042161090400	
40	1/2" ID (Ø 12,700)	28.6	44.5	64.0	46.0	9042161120400	
40	5/8" ID (Ø 15,870)	34.6	44.5	64.0	49.0	9042161150400	
40	3/4" ID (Ø 19,050)	38.4	44.5	64.0	51.0	9042161190400	
40	1" ID (Ø 25,400)	44.0	49.5	81.0	57.0	9042161250400	
40	1 1/4" ID (Ø 31,750)	63.0	80.0	81.0	61.0	9042161310400	
50	1/4" ID (Ø 6,350)	25.7	69.9	81.0	37.0	9042161060500	
50	3/8" ID (Ø 9,520)	36.2	69.9	81.0	41.0	9042161090500	
50	1/2" ID (Ø 12,700)	46.2	69.9	81.0	46.0	9042161120500	
50	5/8" ID (Ø 15,870)	46.0	69.9	81.0	49.0	9042161150500	
50	3/4" ID (Ø 19,050)	55.5	69.9	81.0	51.0	9042161190500	
50	1" ID (Ø 25,400)	55.5	69.9	81.0	57.0	9042161250500	
50	1 1/4" ID (Ø 31,750)	55.5	69.9	81.0	61.0	9042161310500	
40	6.0MM ID	26.1	44.5	64.0	37.0	9042160060400	
40	8.0MM ID	28.0	44.5	64.0	37.0	9042160080400	
40	10.0MM ID	27.3	44.5	64.0	41.0	9042160100400	
40	12.0MM ID	28.6	44.5	64.0	46.0	9042160120400	
40	14.0MM ID	30.6	44.5	64.0	46.0	9042160140400	
40	16.0MM ID	34.6	44.5	64.0	49.0	9042160160400	
40	18.0MM ID	38.5	44.5	64.0	49.0	9042160180400	
40	20.0MM ID	38.5	44.5	64.0	51.0	9042160200400	
40	25.0MM ID	49.5	49.5	81.0	57.0	9042160250400	
40	32.0MM ID	49.5	49.5	81.0	61.0	9042160320400	
50	6.0MM ID	25.7	69.9	81.0	37.0	9042160060500	
50	8.0MM ID	36.2	69.9	81.0	41.0	9042160080500	
50	10.0MM ID	36.2	69.9	81.0	41.0	9042160100500	
50	12.0MM ID	46.2	69.9	81.0	46.0	9042160120500	
50	14.0MM ID	46.2	69.9	81.0	47.5	9042160140500	
50	16.0MM ID	45.5	69.9	81.0	49.0	9042160160500	
50	18.0MM ID	55.5	69.9	81.0	51.0	9042160180500	
50	20.0MM ID	55.5	69.9	81.0	51.0	9042160200500	
50	25.0MM ID	55.5	69.9	81.0	57.0	9042160250500	
50	32.0MM ID	55.5	69.9	81.0	61.0	9042160320500	

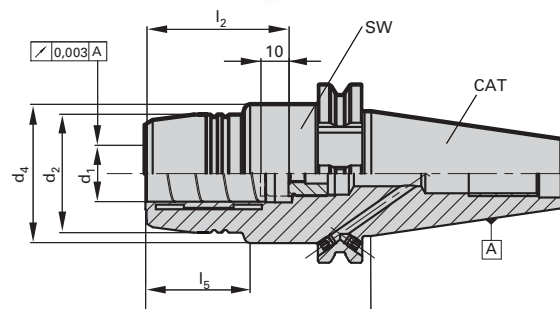

CAT GUHROJET SHRINK FIT HOLDER

Product information

- Optimized cooling for tools without internal coolant ducts
- Good chip evacuation and increased process reliability
- balancing quality G6.3 / 15.000rev./min.
- including balancing threads 4x M6 / 6xM6
- taper according to ANSI/ASME B 5.50
- coolant through center and also through flange (plugged with threaded pins when supplied)

Scope of delivery

- including setting screw, Guhring no. 4938
- with slots for coolant supply
- special dimensions on request



						Series Number	4765
CAT	for clamping dia. d1 in h6 inch	d ₂ mm	d ₄ mm	l ₁ mm	l ₂ mm	EDP Numbers	
40	1/4" ID (Ø 6,350)	21.00	27.00	80.00	36.00	9047651060400	
40	3/8" ID (Ø 9,520)	24.00	32.00	80.00	41.00	9047651090400	
40	1/2" ID (Ø 12,700)	24.00	32.00	80.00	46.00	9047651120400	
40	5/8" ID (Ø 15,870)	27.00	34.00	80.00	49.00	9047651150400	
40	3/4" ID (Ø 19,050)	33.00	42.00	80.00	49.00	9047651190400	



CAT SHRINK FIT HOLDER

Product information

- balancing quality G6.3 / 15.000rev./min.
- including balancing threads 4x M6 / 6xM6
- taper according to ANSI/ASME B 5.50
- coolant through center and also through flange (plugged with threaded pins when supplied)

Scope of delivery

- including setting screw, Guhring no. 4977 with axial force dampening for perfect runout accuracy
- special dimensions on request



Series Number						4764
CAT	clamping dia. d1 in h6 inch	d ₂ mm	d ₄ mm	l ₁ mm	l ₂ mm	EDP Numbers
40	Ø1/4" ID (Ø 6,350)	21.00	27.00	80.00	36.00	9047641060400
40	Ø 3/8" ID (Ø 9,520)	24.00	32.00	80.00	41.00	9047641090400
40	Ø1/2" ID (Ø 12,700)	24.00	32.00	80.00	46.00	9047641120400
40	Ø 5/8" ID (Ø 15,870)	27.00	34.00	80.00	49.00	9047641150400
40	Ø 3/4" ID (Ø 19,050)	33.00	42.00	80.00	49.00	9047641190400
40	Ø 1" ID (Ø 25,400)	44.00	53.00	100.00	57.00	9047641250400
40	Ø 1 1/4" ID (Ø 31,750)	44.00	53.00	100.00	58.00	9047641310400
40	6.0MM ID	21.00	27.00	80.00	36.00	9047640060400
40	8.0MM ID	21.00	27.00	80.00	36.00	9047640080400
40	10.0MM ID	24.00	32.00	80.00	41.00	9047640100400
40	12.0MM ID	24.00	32.00	80.00	46.00	9047640120400
40	14.0MM ID	27.00	34.00	80.00	46.00	9047640140400
40	16.0MM ID	27.00	34.00	80.00	49.00	9047640160400
40	18.0MM ID	33.00	42.00	80.00	49.00	9047640180400
40	20.0MM ID	33.00	42.00	80.00	51.00	9047640200400
40	25.0MM ID	44.00	53.00	100.00	57.00	9047640250400
40	32.0MM ID	44.00	53.00	100.00	58.00	9047640320400
50	Ø1/4" ID (Ø 6,350)	21.00	27.00	80.00	36.00	9047641060500
50	Ø 3/8" ID (Ø 9,520)	24.00	32.00	80.00	41.00	9047641090500
50	Ø1/2" ID (Ø 12,700)	24.00	32.00	80.00	46.00	9047641120500
50	Ø 5/8" ID (Ø 15,870)	27.00	34.00	80.00	49.00	9047641150500
50	Ø 3/4" ID (Ø 19,050)	33.00	42.00	80.00	49.00	9047641190500
50	Ø 1" ID (Ø 25,400)	44.00	53.00	100.00	57.00	9047641250500
50	Ø 1 1/4" ID (Ø 31,750)	44.00	53.00	100.00	61.00	9047641310500
50	6.0MM ID	21.00	27.00	80.00	36.00	9047650060500
50	8.0MM ID	21.00	27.00	80.00	36.00	9047650080500
50	10.0MM ID	24.00	32.00	80.00	41.00	9047640100500
50	12.0MM ID	24.00	32.00	80.00	46.00	9047640120500
50	14.0MM ID	27.00	34.00	80.00	46.00	9047640140500
50	16.0MM ID	27.00	34.00	80.00	49.00	9047640160500
50	18.0MM ID	33.00	42.00	80.00	49.00	9047640180500
50	20.0MM ID	33.00	42.00	80.00	51.00	9047640200500
50	25.0MM ID	44.00	53.00	100.00	57.00	9047640250500
50	32.0MM ID	44.00	53.00	100.00	61.00	9047640320500

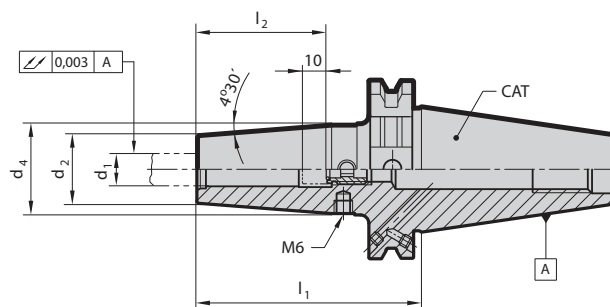

HMC 3000



HYDRAULIC MICRO CHUCKS

GM3000
HSK63

HSK-A hydraulic chucks HMC 3000 for clamping small diameters

Product information

- perfect concentricity: <math>< 3 \mu\text{m}</math> at 10xd1
- balancing quality: G6.3 / 30,000 rev./min
- HSK-A to DIN 69893
- high clamping force
- quick, simple handling and accurate length setting
- IC and GÜHROJET peripheral cooling ensure optimal chip evacuation and tool lubrication

Scope of delivery

- incl. length adjustment screw
- incl. hexagon chuck key Guhring no. 4912
- order coolant delivery set Guhring no. 4949 separately

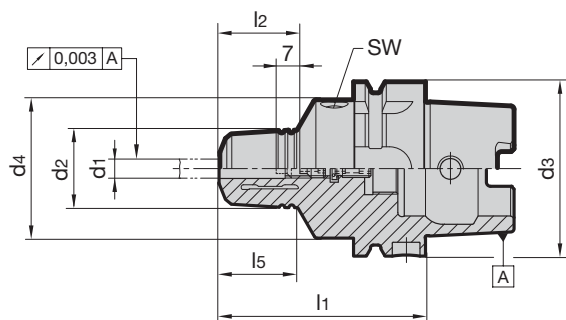

GÜHROJET

Series Number

4618

HSK-A d_3	for shank \varnothing $d_{1\ h6}$ mm	d_2 mm	d_4 mm	l_1 mm	l_2 mm	l_5 mm	SW	EDP Numbers
32	3	28	40.0	84.0	34	33	4	9046180030320
32	4	28	40.0	84.0	34	33	4	9046180040320
32	5	28	40.0	84.0	34	33	4	9046180050320
40	3	28	33.5	74	34	40	4	9046180030400
40	4	28	33.5	74	34	40	4	9046180040400
40	5	28	33.5	74	34	40	4	9046180050400
50	3	28	40	74	34	32	4	9046180030500
50	4	28	40	74	34	32	4	9046180040500
50	5	28	40	74	34	32	4	9046180050500
63	3	28	50	74	34	28.5	5	9046180030630
63	4	28	50	74	34	28.5	5	9046180040630
63	5	28	50	74	34	28.5	5	9046180050630
100	3	28	50	79	34	30	5	9046180030100
100	4	28	50	79	34	30	5	9046180040100
100	5	28	50	79	34	30	5	9046180050100

MAS/BT hydraulic chucks HMC 3000 for clamping small diameters

Product information

- perfect concentricity: < 3 µm at 10xd1
- balancing quality: G6.3 / 30,000 rev./min
- MAS/BT to JIS B 6339 form AD/B (*: version AD without coolant supply over collar)
- high clamping force
- quick, simple handling and accurate length setting
- IC and GÜHROJET peripheral cooling ensure optimal chip evacuation and tool lubrication

Scope of delivery

- incl. length adjustment screw
- incl. hexagon chuck key Guhring no. 4912

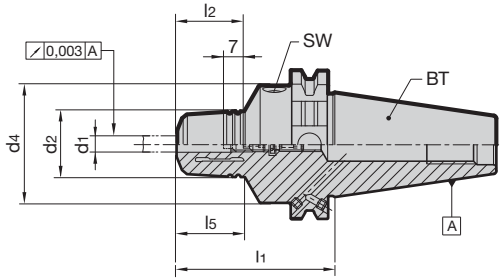

GÜHROJET

Series Number **4620**

BT	for shank Ø d _{1 h6} mm	d ₂ mm	d ₄ mm	l ₁ mm	l ₂ mm	l ₅ mm	SW	EDP Numbers
30*	3	28.0	-	55.0	34	22.5	4	9046200030300
30*	4	28.0	-	55.0	34	22.5	4	9046200040300
30*	5	28.0	-	55.0	34	22.5	4	9046200050300
40	3	28.0	44.5	94.0	34	48.5	5	9046200030400
40	4	28.0	44.5	94.0	34	48.5	5	9046200040400
40	5	28.0	44.5	94.0	34	48.5	5	9046200050400



TSG 3000



THERMO SECURE GOLD 3000 SHRINK FIT CHUCK

THERMO SECURE GOLD 3000

with temperature indicator
for maximum operational safety

1. Shrink fitting:
The chuck is heated up in the shrink fit system. Due to the radial expansion the tool can be inserted.



2. Red ring:
The chuck is hot following shrink fitting for insertion. Risk of burning!



3. Putting on the cooling adapter:
Through controlled cooling of the chuck the tool is securely clamped.

4. Blue ring:
The cooling procedure is completed. The chuck now has a temperature below appr. 115° F.



5. Finished:
The tool and holder can be removed from the shrink fit system without danger and applied.



ISO Taper shrink fit chucks TSG 3000

Product information

- coating for protection against oxidation, cleanliness and longevity
- safety color ring for maximum operator safety
- with axial damping screw for optimal concentricity
- max. deviation f. concentricity 3 μm
- for tool shank tolerance h6
- ISO taper to DIN 69871 form AD/B
- balancing quality G6.3 / 15,000 rev./min
- designed with 6xM6 balancing screws for the highest accuracy

Scope of delivery

- incl. length setting screw with axial force damping Guhring no. 4941 for conventional cooling
- special dimensions on request
- for MQL application order as special tool holder

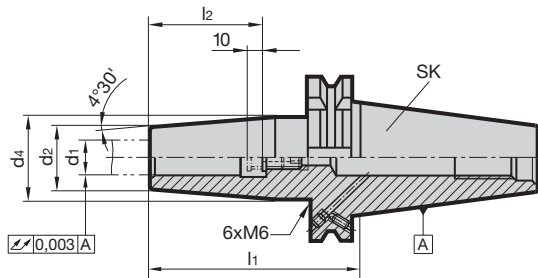

Series Number **4727**

ISO Taper	for shank \varnothing $d_{1\ h6}$ mm	d_2 mm	d_4 mm	l_1 mm	l_2 mm	incl. setting screw Guhring no. 4941	kg	EDP Numbers
40	6	21	27	80	36	6.041	1.00	9047270060400
40	8	21	27	80	36	8.040	1.00	9047270080400
40	10	24	32	80	41	10.050	1.00	9047270100400
40	12	24	32	80	46	12.100	1.00	9047270120400
40	14	27	34	80	46	14.100	1.00	9047270140400
40	16	27	34	80	49	16.100	1.00	9047270160400
40	18	33	42	80	49	18.100	1.00	9047270180400
40	20	33	42	80	51	20.100	1.50	9047270200400
40	25	44	53	100	57	25.100	1.50	9047270250400
40	32	44	53	100	61	32.100	1.50	9047270320400

MAS-BT shrink fit chucks TSG 3000

Product information

- coating for protection against oxidation, cleanliness and longevity
- safety color ring for maximum operator safety
- with axial damping screw for optimal concentricity
- MAS BT to JIS B 6339
- for tool shank tolerance h6
- balancing quality G6.3 / 15,000 rev./min
- designed with 6xM6 balancing screws for the highest accuracy

Scope of delivery

- incl. setting screw Guhring no. 4941 with axial force damping
- special dimensions on request
- MAS-BT 50 on request
- order as special holder for MQL application

Series Number **4728**

MAS-BT Taper	for shank \varnothing $d_{1\ h6}$ mm	d_2 mm	d_4 mm	l_1 mm	l_2 mm	incl. setting screw Guhring no. 4941	EDP Numbers
40	6	21	27	90	36	6.041	9047280060400
40	8	21	27	90	36	8.040	9047280080400
40	10	24	32	90	41	10.050	9047280100400
40	12	24	32	90	46	12.100	9047280120400
40	14	27	34	90	46	14.100	9047280140400
40	16	27	34	90	49	16.100	9047280160400
40	18	33	42	90	49	18.100	9047280180400
40	20	33	42	90	51	20.100	9047280200400
40	25	44	53	100	57	25.100	9047280250400
40	32	44	53	100	57	32.100	9047280320400

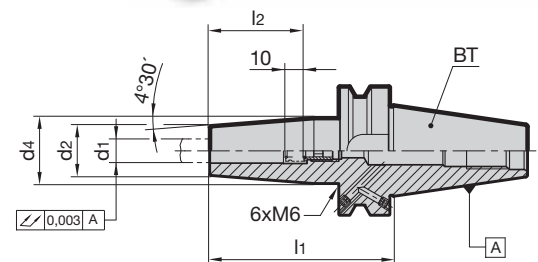

HSK-A shrink fit chucks TSG 3000

Product information

- coating for protection against oxidation, cleanliness and longevity
- safety color ring for maximum operator safety
- with axial damping screw for optimal concentricity
- MQL suitable
- for tool shank tolerance h6
- to DIN 69882-8
- balancing quality G6.3 at 15,000 rev./min
- designed with 6xM6 balancing screws for the highest accuracy

Scope of delivery

- incl. setting screw, Guhring no. 4941
- for conventional cooling order coolant delivery set, Guhring no. 4949, separately
- for MQL application order as special tool holder with coolant delivery set
- special dimensions on request

Series Number 4726

HSK-A d ₃	for shank Ø d _{1 h6} mm	d ₂ mm	d ₄ mm	l ₁ mm	l ₂ mm	incl. setting screw Guhring no. 4941	SW	EDP Numbers
63	6	21	27	80	36	6.100	1.00	9047260060630
63	8	21	27	80	36	8.100	1.00	9047260080630
63	10	24	32	85	41	10.100	1.00	9047260100630
63	12	24	32	90	46	12.100	1.00	9047260120630
63	14	27	34	90	46	14.100	1.00	9047260140630
63	16	27	34	95	49	16.100	1.00	9047260160630
63	18	33	42	95	49	18.100	1.00	9047260180630
63	20	33	42	100	51	20.100	1.00	9047260200630
63	25	44	53	115	57	25.100	2.00	9047260250630
63	32	44	53	120	61	32.100	2.00	9047260320630
100	6	21	27	85	36	6.100	2.00	9047260061000
100	8	21	27	85	36	8.100	2.00	9047260081000
100	10	24	32	90	41	10.100	2.00	9047260101000
100	12	24	32	95	46	12.100	2.00	9047260121000
100	14	27	34	95	46	14.100	2.00	9047260141000
100	16	27	34	100	49	16.100	2.00	9047260161000
100	18	33	42	100	49	18.100	2.50	9047260181000
100	20	33	42	105	51	20.100	2.50	9047260201000
100	25	44	53	115	57	25.100	3.00	9047260251000
100	32	44	53	120	61	32.100	3.00	9047260321000



MQL
by GÜHRING

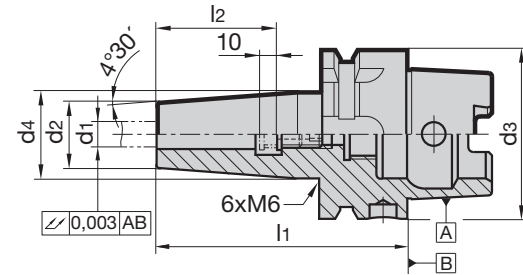

Notes:

DRILLING

TAPPING/
THREADMILLING/
FLUTELESS TAPPING

MILLING

REAMING

PCD/PCBN



SPECIAL TOOLING
SOLUTIONS

COUNTERSINKING/
DE-BURRING

MODULAR TOOLING
SYSTEMS

TOOL RECONDITIONING SERVICE

GUHRING

The Tool Company

Guhring, Inc. Main Office
 P.O. Box 643, Brookfield, WI 53008-0643

Shipping Address
 1445 Commerce Avenue
 Brookfield, WI 53045
 Tel (262) 784-6730 (800) 776-6170
 Fax (262) 784-9096

**West Coast Distribution Center and
 Reconditioning Facility**
 15581 Computer Ln
 Huntington Beach, CA 92649

Reconditioning Facility
 121 W Dudley Town Rd.
 Bloomfield, CT 06002

**Manufacturing and
 Reconditioning Facility**
 29550 W.K. Smith Rd. Suite B
 New Hudson, MI 48165

Guhring Corporation
 20 Steckle Place, Unit #14
 Kitchener, ON N2E 2C3
 Tel (519) 748-9664 (800) 463-5555
 Fax (519) 748-2954