

powerMILL

GUHRING

UNIVERSAL MILLING CUTTER PROGRAMME

Unique in
PRICE AND EFFICIENCY



PM01

powerMILL

With the **POWERMILL PROGRAMME** Guhring introduces a complete range of universal milling cutters onto the market that promises optimal performance as an all-rounder at first class prices



Unique in
PRICE AND EFFICIENCY



Unique in
PRICE AND EFFICIENCY

Face cutting geometries of Guhring's established milling cutters were optimised to achieve high metal removal rates and longer tool life when universal milling. Alongside this face cutting correction various milling cutters of the **POWERMILL PROGRAMME** received Guhring's well proven Fire-coating.

Own developed geometries
for maximum performance!

Highly-precision ground on
specially developed machines!

Best fine grain carbide as tool
material!

A complete all-round programme
with universal material suitability

***power*MILL**

P	M	K	N	S	H	Tool illustration	Z	Feed	Shank form	Length	Tool material	Surface	d1/mm	Article no.	Cutting data page	Page
Al slot drills (2-fluted)																
			•						HA		VHM	○	2.000 - 20.000	19994	28	6
			•						HB		VHM	○	2.000 - 20.000	19995	28	6
			•						HA		VHM	○	2.000 - 20.000	19996	28	7
			•						HB		VHM	○	2.000 - 20.000	19997	28	7
Slot drills (3-fluted)																
	○		•	○					HA		VHM	○	2.000 - 20.000	19992	28	8
	○		•	○					HB		VHM	○	2.000 - 20.000	19993	28	8
Slot drills (2-fluted)																
•	•	•	○	•					HA		VHM	Ⓡ	2.000 - 20.000	19988	28	9
•	•	•	○	•					HB		VHM	Ⓡ	2.000 - 20.000	19989	28	9
•	•	•	○	•					Cyl		VHM	Ⓐ	2.000 - 20.000	19962	28	10
•	•	•	○	•					HA		VHM	Ⓡ	3.000 - 20.000	19990	28	11
•	•	•	○	•					HB		VHM	Ⓡ	3.000 - 20.000	19991	28	11
Slot drills (3-fluted)																
•	•	•	○	•					HA		VHM	Ⓡ	2.000 - 20.000	19986	28	12
•	•	•	○	•					HB		VHM	Ⓡ	2.000 - 20.000	19987	28	12
•	•	•	○	•					HA		VHM	Ⓡ	2.000 - 20.000	19982	28	13
•	•	•	○	•					HB		VHM	Ⓡ	2.000 - 20.000	19983	28	13
•	•	•	○	•					Cyl		VHM	Ⓐ	2.000 - 20.000	19963	28	14
•	•	•	○	•					HA		VHM	Ⓡ	3.000 - 20.000	19984	28	15
•	•	•	○	•					HB		VHM	Ⓡ	3.000 - 20.000	19985	28	15
HPC end mills (4-fluted)																
•	•	•	○	•	○				HA		VHM	Ⓡ	3.000 - 20.000	19980	28	16
•	•	•	○	•	○				HB		VHM	Ⓡ	3.000 - 20.000	19981	28	16

P	M	K	N	S	H	Tool illustration	Z	Feed	Shank form	Length	Tool material	Surface	d1/mm	Article no.	Cutting data page	Page
End mills (4-fluted)																
•	•	•	○	•	○				HA		VHM	F	2.000 - 20.000	19978	28	17
•	•	•	○	•	○				HB		VHM	F	2.000 - 20.000	19979	28	17
•	•	•	○	•	○				Cyl		VHM	A	2.000 - 20.000	19961	28	18
•	•	•	○	•	○				HA		VHM	F	3.000 - 20.000	19976	28	19
•	•	•	○	•	○				HB		VHM	F	3.000 - 20.000	19977	28	19
Multi-tooth end mills (6-fluted)																
•	•	•	•	•	○				HA		VHM	F	3.000 - 20.000	19972	28	20
•	•	•	•	•	○				HB		VHM	F	3.000 - 20.000	19973	28	20
•	•	•	•	•	○				HA		VHM	F	4.000 - 20.000	19974	28	21
•	•	•	•	•	○				HB		VHM	F	4.000 - 20.000	19975	28	21
Ball nose slot drills (2-fluted)																
•	•	•	•	•	○				HA		VHM	F	2.000 - 20.000	19968	28	22
•	•	•	•	•	○				HB		VHM	F	2.000 - 20.000	19969	28	22
•	•	•	•	•	○				HA		VHM	F	3.000 - 12.000	19970	28	23
•	•	•	•	•	○				HB		VHM	F	3.000 - 12.000	19971	28	23
Roughing end mills with fine teeth																
•	•	•	○	•					HA		VHM	F	4.000 - 20.000	19964	28	24
•	•	•	○	•					HB		VHM	F	4.000 - 20.000	19965	28	24
•	•	•	○	•					HA		VHM	F	5.000 - 25.000	19966	28	25
•	•	•	○	•					HB		VHM	F	5.000 - 25.000	19967	28	25

Al slot drills (2-fluted)

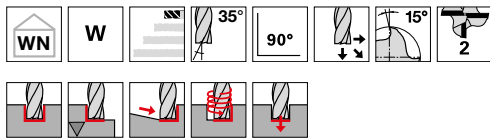

P	
M	
K	
N	•
S	
H	

GUHRING NAVIGATOR

Cutting data page 28

- centre cutting
- with special drill face

Tool material **Solid carbide**

Surface	○	○
Type	W	W
Shank form	HA	HB

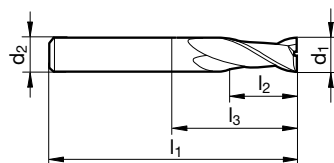

Article no. **19994** **19995**
Discount group **206** **206**

d1 e8	d2 h6	l1	l2	l3	Z	Code no.	EUR/piece	
mm	mm	mm	mm	mm				
2.000	4.000	40.000	3.000	6.400	2	2.000	8.60	
3.000	4.000	40.000	4.000	8.900	2	3.000	8.60	
4.000	6.000	50.000	5.000	10.400	2	4.000	8.60	9.45
5.000	6.000	50.000	6.000	12.900	2	5.000	8.60	9.45
6.000	6.000	50.000	7.000	14.000	2	6.000	8.60	9.45
8.000	8.000	58.000	9.000	22.000	2	8.000	10.35	11.20
10.000	10.000	66.000	11.000	26.000	2	10.000	13.90	15.15
12.000	12.000	73.000	12.000	28.000	2	12.000	22.30	23.55
14.000	14.000	75.000	14.000	30.000	2	14.000	30.60	31.85
16.000	16.000	82.000	16.000	34.000	2	16.000	33.20	35.25
18.000	18.000	84.000	18.000	36.000	2	18.000	45.10	47.20
20.000	20.000	92.000	20.000	42.000	2	20.000	60.15	62.20

Al slot drills (2-fluted)

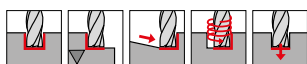
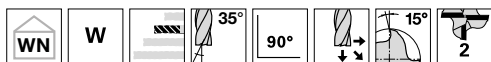

P **GUHRING NAVIGATOR**
M Cutting data page 28
K
N ●
S
H ● centre cutting
 ● with special drill face

Tool material	Solid carbide	
Surface	○	○
Type	W	W
Shank form	HA	HB

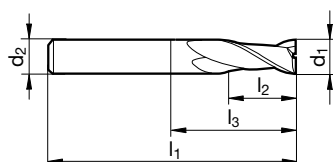

							Article no.	19996	19997
							Discount group	206	206
d1 e8	d2 h6	l1	l2	l3	Z	Code no.	EUR/piece		
mm	mm	mm	mm	mm					
2.000	4.000	40.000	7.000	10.400	2	2.000	11.20		
3.000	4.000	50.000	9.000	13.900	2	3.000	11.20		
4.000	6.000	57.000	11.000	16.400	2	4.000	11.20	12.05	
5.000	6.000	57.000	13.000	19.900	2	5.000	11.20	12.05	
6.000	6.000	57.000	13.000	21.000	2	6.000	11.20	12.05	
8.000	8.000	63.000	19.000	28.000	2	8.000	12.75	13.60	
10.000	10.000	72.000	22.000	33.000	2	10.000	22.30	23.55	
12.000	12.000	83.000	26.000	40.000	2	12.000	33.20	34.45	
14.000	14.000	83.000	26.000	41.000	2	14.000	40.45	41.70	
16.000	16.000	92.000	32.000	49.000	2	16.000	53.90	56.00	
18.000	18.000	92.000	32.000	50.000	2	18.000	64.30	66.35	
20.000	20.000	104.000	38.000	58.000	2	20.000	85.05	87.10	

Slot drills (3-fluted)

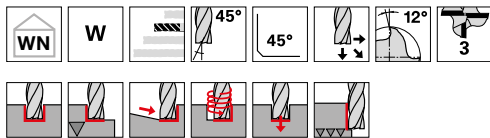

P	
M	○
K	
N	●
S	○
H	

GUHRING NAVIGATOR

Cutting data page 28

- high-performance slot drill with a quick helix for an especially smooth cutting operation
- centre cutting
- with special drill face

Tool material	Solid carbide	
Surface	○	○
Type	W	W
Shank form	HA	HB

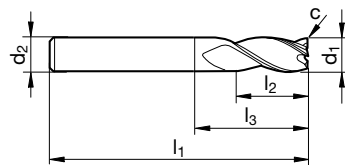

								Article no.	19992	19993
								Discount group	206	206
d1 e8	d2 h6	l1	l2	l3	c	Z	Code no.	EUR/piece		
mm	mm	mm	mm	mm	mm x 45°					
2.000	4.000	50.000	6.000	8.900	0.030	3	2.000	11.80		
3.000	6.000	57.000	8.000	11.900	0.050	3	3.000	10.80	11.60	
4.000	6.000	57.000	11.000	14.900	0.060	3	4.000	10.15	11.00	
5.000	6.000	57.000	13.000	18.400	0.080	3	5.000	10.15	11.00	
6.000	6.000	57.000	13.000	21.000	0.090	3	6.000	10.80	11.60	
8.000	8.000	63.000	19.000	27.000	0.120	3	8.000	12.25	13.05	
10.000	10.000	72.000	22.000	32.000	0.150	3	10.000	20.75	22.00	
12.000	12.000	83.000	26.000	38.000	0.180	3	12.000	30.05	31.30	
14.000	14.000	83.000	26.000	38.000	0.210	3	14.000	37.35	38.60	
16.000	16.000	92.000	32.000	44.000	0.190	3	16.000	53.90	56.00	
20.000	20.000	104.000	38.000	54.000	0.240	3	20.000	87.10	89.20	

Slot drills (2-fluted)

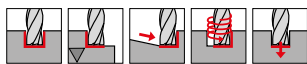
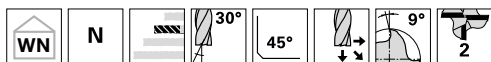

- P** • **GUHRING NAVIGATOR**
M • Cutting data page 28
K •
N ○
S •
H •
- centre cutting
 - with special drill face

Tool material	Solid carbide	
Surface	F	F
Type	N	N
Shank form	HA	HB

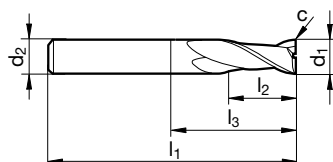

								Article no.	19988	19989
								Discount group	206	206
d1 e8	d2 h6	l1	l2	l3	c	Z	Code no.	EUR/piece		
mm	mm	mm	mm	mm	mm x 45°					
2.000	4.000	40.000	6.000	9.400	0.020	2	2.000	13.25		
3.000	4.000	50.000	8.000	12.900	0.030	2	3.000	12.95		
4.000	6.000	50.000	11.000	16.400	0.040	2	4.000	12.75	13.60	
5.000	6.000	50.000	13.000	19.900	0.050	2	5.000	12.75	13.60	
6.000	6.000	50.000	13.000	20.000	0.060	2	6.000	12.45	13.25	
7.000	8.000	60.000	16.000	23.100	0.070	2	7.000	20.75	21.55	
8.000	8.000	60.000	19.000	27.000	0.080	2	8.000	16.60	17.40	
9.000	10.000	70.000	19.000	29.100	0.090	2	9.000	29.05	30.30	
10.000	10.000	70.000	22.000	30.000	0.100	2	10.000	24.35	25.60	
11.000	12.000	75.000	22.000	29.100	0.110	2	11.000	32.15	33.40	
12.000	12.000	75.000	26.000	39.000	0.120	2	12.000	34.75	36.00	
14.000	14.000	75.000	26.000	40.000	0.140	2	14.000	47.20	48.45	
16.000	16.000	75.000	26.000	43.000	0.160	2	16.000	69.50	71.55	
18.000	18.000	100.000	32.000	52.000	0.180	2	18.000	87.10	89.20	
20.000	20.000	100.000	32.000	50.000	0.200	2	20.000	91.25	93.35	

Slot drills (2-fluted)

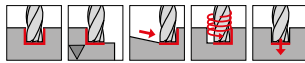
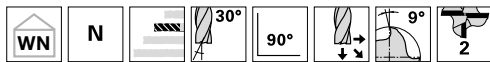

P • **GUHRING NAVIGATOR**
M • Cutting data page 28
K •
N ○
S •
H • centre cutting

Tool material	Solid carbide
Surface	A
Type	N
Shank form	cyl.

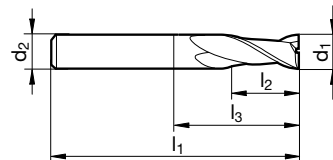

							Article no.	19962
							Discount group	206
d1 h8	d2 h6	l1	l2	l3	Z	Code no.	EUR/piece	
mm	mm	mm	mm	mm				
2.000	4.000	40.000	6.000	9.400	2	2.000	11.50	
3.000	6.000	45.000	8.000	12.900	2	3.000	10.25	
4.000	6.000	45.000	11.000	16.400	2	4.000	11.50	
5.000	6.000	50.000	13.000	19.900	2	5.000	9.65	
6.000	6.000	50.000	13.000	20.000	2	6.000	12.45	
8.000	8.000	60.000	19.000	27.000	2	8.000	16.60	
10.000	10.000	70.000	22.000	32.000	2	10.000	24.60	
12.000	12.000	75.000	26.000	39.000	2	12.000	34.85	
16.000	16.000	75.000	32.000	48.000	2	16.000	57.95	
20.000	20.000	100.000	40.000	59.000	2	20.000	91.65	

XL slot drills (2-fluted)

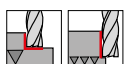
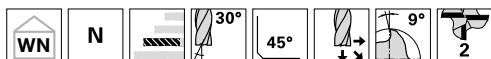

- P** • **GUHRING NAVIGATOR**
 - M** • Cutting data page 28
 - K** •
 - N** ○
 - S** •
 - H** •
- centre cutting
• with special drill face

Tool material	Solid carbide	
Surface	F	F
Type	N	N
Shank form	HA	HB

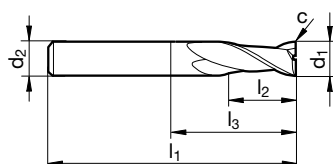

								Article no.	19990	19991
								Discount group	206	206
d1 e8	d2 h6	l1	l2	l3	c	Z	Code no.	EUR/piece		
mm	mm	mm	mm	mm	mm x 45°					
3.000	3.000	60.000	20.000	32.000	0.030	2	3.000	15.65		
4.000	4.000	60.000	20.000	32.000	0.040	2	4.000	17.40		
5.000	5.000	75.000	25.000	47.000	0.050	2	5.000	18.45		
6.000	6.000	75.000	30.000	39.000	0.060	2	6.000	18.45	19.30	
8.000	8.000	75.000	30.000	39.000	0.080	2	8.000	35.25	36.10	
10.000	10.000	100.000	40.000	60.000	0.100	2	10.000	43.05	44.30	
12.000	12.000	100.000	45.000	55.000	0.120	2	12.000	66.35	67.60	
14.000	14.000	100.000	45.000	55.000	0.140	2	14.000	86.05	87.30	
16.000	16.000	100.000	45.000	62.000	0.160	2	16.000	106.80	108.90	
18.000	18.000	100.000	45.000	63.000	0.180	2	18.000	124.45	126.50	
20.000	20.000	100.000	45.000	62.000	0.200	2	20.000	144.15	146.20	

Slot drills (3-fluted)

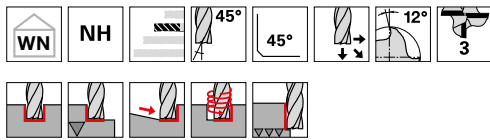

P • **GUHRING NAVIGATOR**
M • Cutting data page 28
K •
N ○
S •
H •

- high-performance slot drill with a quick helix for an especially smooth cutting operation
- centre cutting
- with special drill face

Tool material	Solid carbide	
Surface	F	F
Type	NH	NH
Shank form	HA	HB

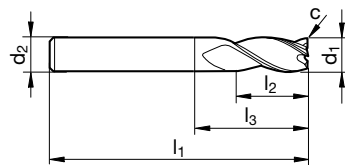

								Article no.	19986	19987
								Discount group	206	206
d1 e8	d2 h6	l1	l2	l3	c	Z	Code no.	EUR/piece		
mm	mm	mm	mm	mm	mm x 45°					
2.000	4.000	50.000	6.000	8.900	0.030	3	2.000	14.10		
3.000	6.000	57.000	8.000	11.900	0.050	3	3.000	12.85	13.70	
4.000	6.000	57.000	11.000	14.900	0.060	3	4.000	12.65	13.50	
5.000	6.000	57.000	13.000	18.400	0.080	3	5.000	12.65	13.50	
6.000	6.000	57.000	13.000	21.000	0.090	3	6.000	13.05	13.90	
8.000	8.000	63.000	19.000	27.000	0.120	3	8.000	16.80	17.65	
10.000	10.000	72.000	22.000	32.000	0.150	3	10.000	23.85	25.10	
12.000	12.000	83.000	26.000	38.000	0.180	3	12.000	37.35	38.60	
14.000	14.000	83.000	26.000	38.000	0.210	3	14.000	45.65	46.85	
16.000	16.000	92.000	32.000	44.000	0.240	3	16.000	61.20	63.25	
20.000	20.000	104.000	38.000	54.000	0.300	3	20.000	98.50	100.60	

Slot drills (3-fluted)

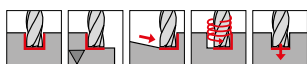
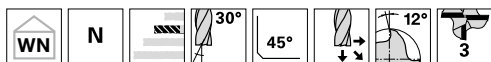

P	•	GUHRING NAVIGATOR	
M	•		Cutting data page 28
K	•		
N	○		
S	•		
H		<ul style="list-style-type: none"> • centre cutting • with special drill face 	

Tool material	Solid carbide	
Surface	F	F
Type	N	N
Shank form	HA	HB

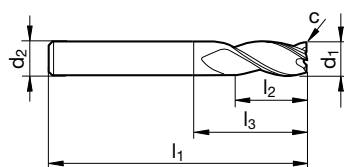

								Article no.	19982	19983
								Discount group	206	206
d1 e8	d2 h6	l1	l2	l3	c	Z	Code no.	EUR/piece		
mm	mm	mm	mm	mm	mm x 45°					
2.000	4.000	50.000	6.000	9.400	0.030	3	2.000	12.95		
3.000	6.000	57.000	8.000	12.900	0.050	3	3.000	12.95	13.80	
4.000	6.000	57.000	11.000	16.400	0.060	3	4.000	12.75	13.60	
5.000	6.000	57.000	13.000	19.900	0.080	3	5.000	12.45	13.25	
6.000	6.000	57.000	13.000	21.000	0.090	3	6.000	12.45	13.25	
8.000	8.000	63.000	19.000	27.000	0.120	3	8.000	16.60	17.40	
10.000	10.000	72.000	22.000	32.000	0.150	3	10.000	24.35	25.60	
12.000	12.000	83.000	26.000	38.000	0.180	3	12.000	37.35	38.60	
14.000	14.000	83.000	26.000	38.000	0.210	3	14.000	46.65	47.90	
16.000	16.000	92.000	32.000	44.000	0.190	3	16.000	58.05	60.15	
20.000	20.000	104.000	38.000	54.000	0.240	3	20.000	91.25	93.35	

Slot drills (3-fluted)

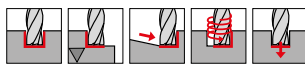
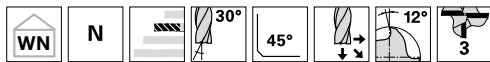

- P** • **GUHRING NAVIGATOR**
M • Cutting data page 28
K •
N ○
S •
H • centre cutting
 • with special drill face

Tool material	Solid carbide
Surface	A
Type	N
Shank form	cyl.

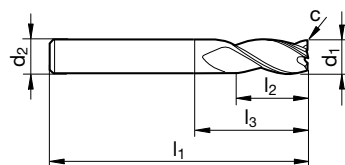

								Article no.	19963
								Discount group	206
d1 h8	d2 h6	l1	l2	l3	c	Z	Code no.	EUR/piece	
mm	mm	mm	mm	mm	mm x 45°				
2.000	4.000	40.000	6.000	9.400	0.030	3	2.000	11.50	
3.000	6.000	45.000	8.000	12.900	0.050	3	3.000	11.50	
4.000	6.000	45.000	11.000	16.400	0.060	3	4.000	11.20	
5.000	6.000	50.000	13.000	19.900	0.080	3	5.000	11.20	
6.000	6.000	50.000	13.000	19.000	0.090	3	6.000	12.45	
8.000	8.000	60.000	19.000	25.500	0.120	3	8.000	16.60	
10.000	10.000	70.000	22.000	30.000	0.150	3	10.000	24.60	
12.000	12.000	75.000	26.000	36.000	0.180	3	12.000	34.85	
16.000	16.000	75.000	32.000	44.000	0.240	3	16.000	57.95	
20.000	20.000	100.000	40.000	54.000	0.300	3	20.000	91.65	

Slot drills XL (3-fluted)

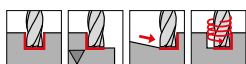
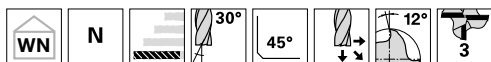

- P** • **GUHRING NAVIGATOR**
M • Cutting data page 28
K •
N ○
S •
H •
- centre cutting
 - with special drill face

Tool material	Solid carbide	
Surface	F	F
Type	N	N
Shank form	HA	HB

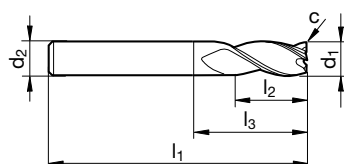

								Article no.	19984	19985
								Discount group	206	206
d1 e8	d2 h6	l1	l2	l3	c	Z	Code no.	EUR/piece		
mm	mm	mm	mm	mm	mm x 45°					
3.000	6.000	57.000	12.000	16.900	0.050	3	3.000	20.75	21.55	
4.000	6.000	63.000	19.000	24.400	0.060	3	4.000	22.30	23.15	
5.000	6.000	68.000	24.000	30.900	0.080	3	5.000	24.90	25.70	
6.000	6.000	72.000	24.000	36.000	0.090	3	6.000	32.65	33.50	
8.000	8.000	88.000	38.000	52.000	0.120	3	8.000	42.00	42.85	
10.000	10.000	95.000	45.000	55.000	0.150	3	10.000	54.95	56.20	
12.000	12.000	110.000	53.000	65.000	0.180	3	12.000	78.80	80.05	
14.000	14.000	110.000	53.000	65.000	0.210	3	14.000	113.05	114.30	
16.000	16.000	125.000	63.000	80.000	0.190	3	16.000	148.30	150.35	
20.000	20.000	141.000	75.000	95.000	0.240	3	20.000	193.90	196.00	

HPC end mills (4-fluted)

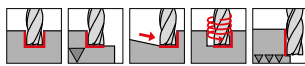
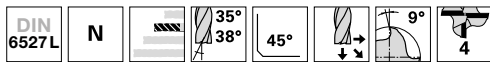

P • **GUHRING NAVIGATOR**

M • Cutting data page 28

K •

N ○

S •

H ○

- high-performance with variable helix angle
- centre cutting

Tool material	Solid carbide	
Surface	F	F
Type	N	N
Shank form	HA	HB

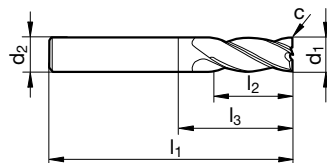

								Article no.	19980	19981
								Discount group	206	206
d1 e8	d2 h6	l1	l2	l3	c	Z	Code no.	EUR/piece		
mm	mm	mm	mm	mm	mm x 45°					
3.000	6.000	57.000	8.000	11.400	0.060	4	3.000	15.95	16.80	
4.000	6.000	57.000	11.000	14.900	0.080	4	4.000	15.95	16.80	
5.000	6.000	57.000	13.000	17.400	0.100	4	5.000	15.95	16.80	
6.000	6.000	57.000	13.000	21.000	0.120	4	6.000	19.50	20.35	
8.000	8.000	63.000	19.000	27.000	0.160	4	8.000	26.95	27.80	
10.000	10.000	72.000	22.000	32.000	0.200	4	10.000	40.95	42.20	
12.000	12.000	83.000	26.000	38.000	0.240	4	12.000	51.85	53.10	
14.000	14.000	83.000	26.000	38.000	0.280	4	14.000	70.50	71.75	
16.000	16.000	92.000	32.000	44.000	0.320	4	16.000	90.20	92.30	
20.000	20.000	104.000	38.000	54.000	0.400	4	20.000	140.00	142.05	

End mills (4-fluted)

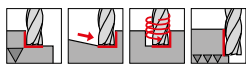
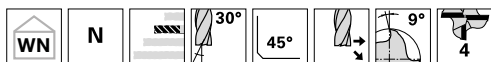

P • **GUHRING NAVIGATOR**
M • Cutting data page 30
K •
N ○
S •
H ○ • centre cutting

Tool material	Solid carbide	
Surface	F	F
Type	N	N
Shank form	HA	HB

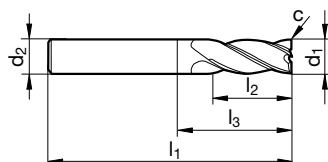

								Article no.	19978	19979
								Discount group	206	206
d1 e8	d2 h6	l1	l2	l3	c	Z	Code no.	EUR/piece		
mm	mm	mm	mm	mm	mm x 45°					
2.000	2.000	32.000	8.000	10.000	0.025	4	2.000	9.45		
3.000	3.000	38.000	12.000	15.000	0.050	4	3.000	9.45		
4.000	4.000	40.000	12.000	16.000	0.050	4	4.000	10.35		
5.000	5.000	50.000	15.000	20.000	0.050	4	5.000	10.35		
6.000	6.000	57.000	16.000	21.000	0.050	4	6.000	16.80	17.65	
7.000	8.000	60.000	16.000	23.900	0.100	4	7.000	13.60	14.40	
8.000	8.000	68.000	22.000	32.000	0.100	4	8.000	23.85	24.70	
9.000	10.000	72.000	22.000	28.400	0.100	4	9.000	22.30	23.55	
10.000	10.000	72.000	25.000	32.000	0.100	4	10.000	34.75	36.00	
11.000	12.000	83.000	26.000	27.600	0.100	4	11.000	49.80	51.00	
12.000	12.000	83.000	28.000	38.000	0.100	4	12.000	45.10	46.35	
14.000	14.000	83.000	28.000	38.000	0.150	4	14.000	60.15	61.40	
16.000	16.000	92.000	35.000	44.000	0.150	4	16.000	76.75	78.80	
18.000	18.000	92.000	35.000	44.000	0.150	4	18.000	101.65	103.70	
20.000	20.000	104.000	40.000	54.000	0.150	4	20.000	120.30	122.35	

End mills (4-fluted)

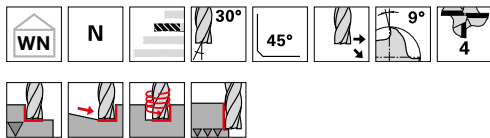

P • **GUHRING NAVIGATOR**
M • Cutting data page 30
K •
N ○
S •
H ○ • centre cutting

Tool material	Solid carbide
Surface	A
Type	N
Shank form	cyl.

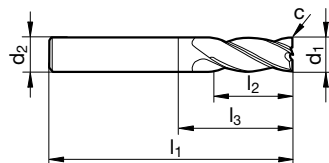

								Article no.	19961
								Discount group	206
d1 h8	d2 h6	l1	l2	l3	c	Z	Code no.	EUR/piece	
mm	mm	mm	mm	mm	mm x 45°				
2.000	4.000	40.000	6.000	8.900	0.025	4	2.000	12.45	
3.000	6.000	45.000	8.000	12.400	0.050	4	3.000	12.45	
4.000	6.000	45.000	11.000	15.900	0.050	4	4.000	12.45	
5.000	6.000	50.000	13.000	19.400	0.050	4	5.000	10.35	
6.000	6.000	50.000	13.000	19.000	0.050	4	6.000	16.80	
8.000	8.000	60.000	19.000	25.500	0.100	4	8.000	23.65	
10.000	10.000	70.000	22.000	30.000	0.100	4	10.000	34.85	
12.000	12.000	75.000	26.000	36.000	0.100	4	12.000	44.90	
16.000	16.000	75.000	32.000	44.000	0.150	4	16.000	65.00	
20.000	20.000	100.000	40.000	54.000	0.150	4	20.000	118.20	

XL end mills (4-fluted)

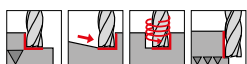
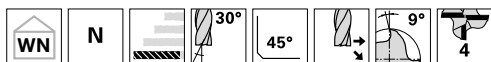

P • **GUHRING NAVIGATOR**
M • Cutting data page 30
K •
N ○
S •
H ○ • centre cutting

Tool material	Solid carbide	
Surface	F	F
Type	N	N
Shank form	HA	HB

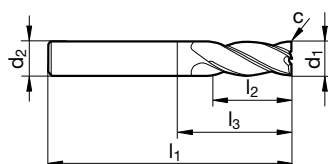

								Article no.	19976	19977
								Discount group	206	206
d1 e8	d2 h6	l1	l2	l3	c	Z	Code no.	EUR/piece		
mm	mm	mm	mm	mm	mm x 45°					
3.000	6.000	57.000	15.000	19.900	0.050	4	3.000	18.45	19.30	
4.000	6.000	63.000	19.000	25.400	0.050	4	4.000	20.75	21.55	
5.000	6.000	68.000	24.000	31.400	0.050	4	5.000	22.30	23.15	
6.000	6.000	68.000	24.000	32.000	0.050	4	6.000	28.00	28.85	
8.000	8.000	88.000	38.000	52.000	0.100	4	8.000	29.05	29.85	
10.000	10.000	95.000	45.000	55.000	0.100	4	10.000	41.50	42.70	
12.000	12.000	110.000	53.000	65.000	0.100	4	12.000	66.35	67.60	
14.000	14.000	110.000	53.000	65.000	0.150	4	14.000	78.80	80.05	
16.000	16.000	125.000	63.000	77.000	0.150	4	16.000	99.55	101.65	
18.000	18.000	125.000	63.000	77.000	0.150	4	18.000	122.35	124.45	
20.000	20.000	141.000	75.000	91.000	0.150	4	20.000	130.65	132.75	

Multi-tooth end mills (6-fluted)

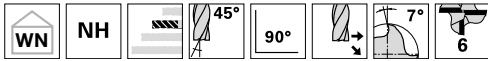

- P** • **GUHRING NAVIGATOR**
- M** • Cutting data page 30
- K** •
- N** •
- S** •
- H** ○ • without centre cutting

Tool material	Solid carbide	
Surface	F	F
Type	NH	NH
Shank form	HA	HB

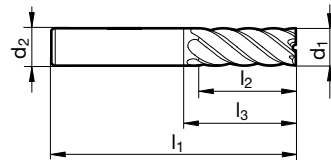

							Article no.	19972	19973
							Discount group	206	206
d1 e8	d2 h6	l1	l2	l3	Z	Code no.	EUR/piece		
mm	mm	mm	mm	mm					
3.000	4.000	50.000	10.000	13.400	6	3.000	17.65		
4.000	6.000	57.000	11.000	15.900	6	4.000	16.80	17.65	
5.000	6.000	57.000	13.000	17.900	6	5.000	15.95	16.80	
6.000	6.000	57.000	13.000	20.000	6	6.000	15.95	16.80	
8.000	8.000	63.000	19.000	26.000	6	8.000	19.10	19.90	
10.000	10.000	72.000	22.000	30.000	6	10.000	30.60	31.85	
12.000	12.000	83.000	26.000	36.000	6	12.000	41.50	42.70	
14.000	14.000	83.000	26.000	36.000	6	14.000	57.05	58.30	
16.000	16.000	92.000	32.000	42.000	6	16.000	74.65	76.75	
18.000	18.000	92.000	32.000	42.000	6	18.000	87.10	89.20	
20.000	20.000	104.000	38.000	52.000	6	20.000	106.80	108.90	

Multi-tooth end mills (6-fluted)

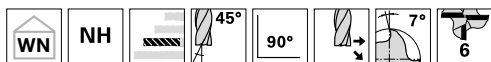

- GUHRING NAVIGATOR**
- P** • Cutting data page 30
 - M** • Cutting data page 30
 - K** •
 - N** •
 - S** •
 - H** ○ • without centre cutting

Tool material	Solid carbide	
Surface	F	F
Type	NH	NH
Shank form	HA	HB

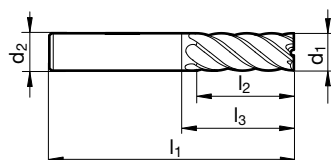

							Article no.	19974	19975
							Discount group	206	206
d1 e8	d2 h6	l1	l2	l3	Z	Code no.	EUR/piece		
mm	mm	mm	mm	mm					
4.000	6.000	63.000	16.000	20.900	6	4.000	24.90	25.70	
5.000	6.000	63.000	18.000	22.900	6	5.000	24.90	25.70	
6.000	6.000	63.000	18.000	26.000	6	6.000	22.80	23.65	
8.000	8.000	68.000	24.000	31.000	6	8.000	26.45	27.25	
10.000	10.000	80.000	30.000	38.000	6	10.000	46.65	47.90	
12.000	12.000	93.000	36.000	46.000	6	12.000	65.35	66.60	
14.000	14.000	100.000	42.000	53.000	6	14.000	91.25	92.50	
16.000	16.000	108.000	48.000	58.000	6	16.000	117.20	119.25	
18.000	18.000	114.000	54.000	64.000	6	18.000	147.25	149.35	
20.000	20.000	126.000	60.000	74.000	6	20.000	178.35	180.45	

Ball nose slot drills (2-fluted)

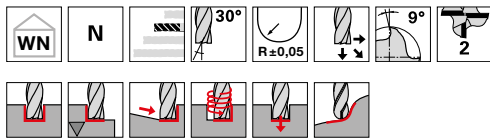

- P** •
- M** •
- K** •
- N** •
- S** •
- H** ○

GUHRING NAVIGATOR

Cutting data page 30

• centre cutting

Tool material	Solid carbide	
Surface	F	F
Type	N	N
Shank form	HA	HB

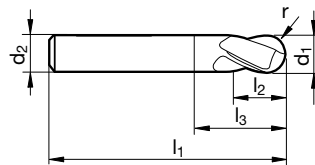

								Article no.	19968	19969
								Discount group	206	206
d1 e8	d2 h6	l1	l2	l3	r	Z	Code no.	EUR/piece		
mm	mm	mm	mm	mm	mm					
2.000	4.000	40.000	6.000	9.400	1.000	2	2.000	14.50		
3.000	4.000	50.000	7.000	11.900	1.500	2	3.000	14.50		
4.000	6.000	50.000	8.000	13.400	2.000	2	4.000	14.50	15.35	
5.000	6.000	50.000	10.000	16.900	2.500	2	5.000	14.50	15.35	
6.000	6.000	50.000	10.000	20.000	3.000	2	6.000	14.50	15.35	
8.000	8.000	60.000	19.000	27.000	4.000	2	8.000	17.10	17.95	
10.000	10.000	70.000	22.000	30.000	5.000	2	10.000	22.30	23.55	
12.000	12.000	75.000	26.000	39.000	6.000	2	12.000	33.70	34.95	
14.000	14.000	75.000	26.000	40.000	7.000	2	14.000	43.55	44.80	
16.000	16.000	75.000	26.000	43.000	8.000	2	16.000	52.90	54.95	
18.000	18.000	100.000	32.000	52.000	9.000	2	18.000	64.30	66.35	
20.000	20.000	100.000	32.000	50.000	10.000	2	20.000	86.05	88.15	

XL ball nose slot drills (2-fluted)

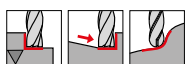
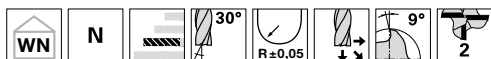

- P** • **GUHRING NAVIGATOR**
- M** • Cutting data page 30
- K** •
- N** •
- S** •
- H** ○ • centre cutting

Tool material	Solid carbide	
Surface	F	F
Type	N	N
Shank form	HA	HB

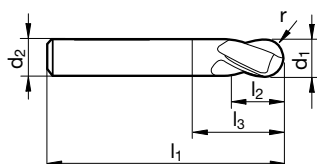

								Article no.	19970	19971
								Discount group	206	206
d1 e8	d2 h6	l1	l2	l3	r	Z	Code no.	EUR/piece		
mm	mm	mm	mm	mm	mm					
3.000	3.000	60.000	20.000	32.000	1.500	2	3.000	29.05		
4.000	4.000	60.000	20.000	32.000	2.000	2	4.000	30.60		
5.000	5.000	75.000	25.000	47.000	2.500	2	5.000	33.70		
6.000	6.000	75.000	30.000	39.000	3.000	2	6.000	37.85	38.70	
8.000	8.000	75.000	30.000	39.000	4.000	2	8.000	43.05	43.85	
10.000	10.000	100.000	40.000	60.000	5.000	2	10.000	58.05	59.30	
12.000	12.000	100.000	45.000	55.000	6.000	2	12.000	76.75	78.00	

Roughing end mills with fine teeth

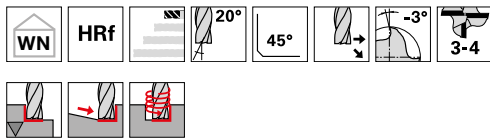

P	•	GUHRING NAVIGATOR Cutting data page 28
M		
K	•	
N		
S	○	
H	•	• centre cutting

Tool material	Solid carbide	
Surface	F	F
Type	HRf	HRf
Shank form	HA	HB

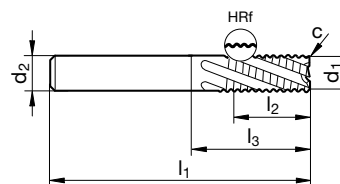

								Article no.	19964	19965
								Discount group	206	206
d1 h10	d2 h6	l1	l2	l3	c	Z	Code no.	EUR/piece		
mm	mm	mm	mm	mm	mm x 45°					
4.000	6.000	54.000	8.000	12.900	0.160	3	4.000	41.50	42.30	
5.000	6.000	54.000	8.000	14.400	0.200	3	5.000	41.50	42.30	
6.000	6.000	54.000	8.000	18.000	0.240	3	6.000	38.35	39.20	
8.000	8.000	58.000	11.000	22.000	0.320	3	8.000	44.60	45.40	
10.000	10.000	66.000	13.000	26.000	0.200	4	10.000	48.75	50.00	
12.000	12.000	73.000	16.000	28.000	0.240	4	12.000	57.05	58.30	
16.000	16.000	82.000	19.000	34.000	0.320	4	16.000	91.25	93.35	
20.000	20.000	92.000	19.000	42.000	0.400	4	20.000	135.85	137.90	

Roughing end mills with fine teeth

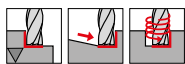
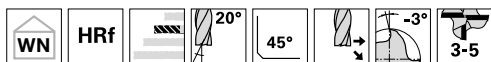

P • **GUHRING NAVIGATOR**
M Cutting data page 28
K •
N
S ○
H • • centre cutting

Tool material	Solid carbide	
Surface	F	F
Type	HRf	HRf
Shank form	HA	HB

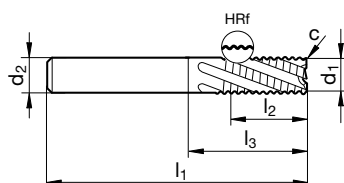

								Article no.	19966	19967
								Discount group	206	206
d1 h10	d2 h6	l1	l2	l3	c	Z	Code no.	EUR/piece		
mm	mm	mm	mm	mm	mm x 45°					
5.000	6.000	57.000	16.000	21.000	0.200	3	5.000	46.65	47.50	
6.000	6.000	57.000	16.000	21.000	0.240	3	6.000	43.05	43.85	
8.000	8.000	63.000	19.000	27.000	0.320	3	8.000	49.80	50.60	
10.000	10.000	72.000	22.000	32.000	0.200	4	10.000	53.90	55.15	
12.000	12.000	83.000	26.000	38.000	0.240	4	12.000	64.30	65.55	
16.000	16.000	92.000	32.000	44.000	0.320	4	16.000	101.65	103.70	
20.000	20.000	104.000	38.000	54.000	0.400	4	20.000	152.45	154.50	
25.000	25.000	121.000	45.000	65.000	0.600	5	25.000	197.05	199.60	



d_2

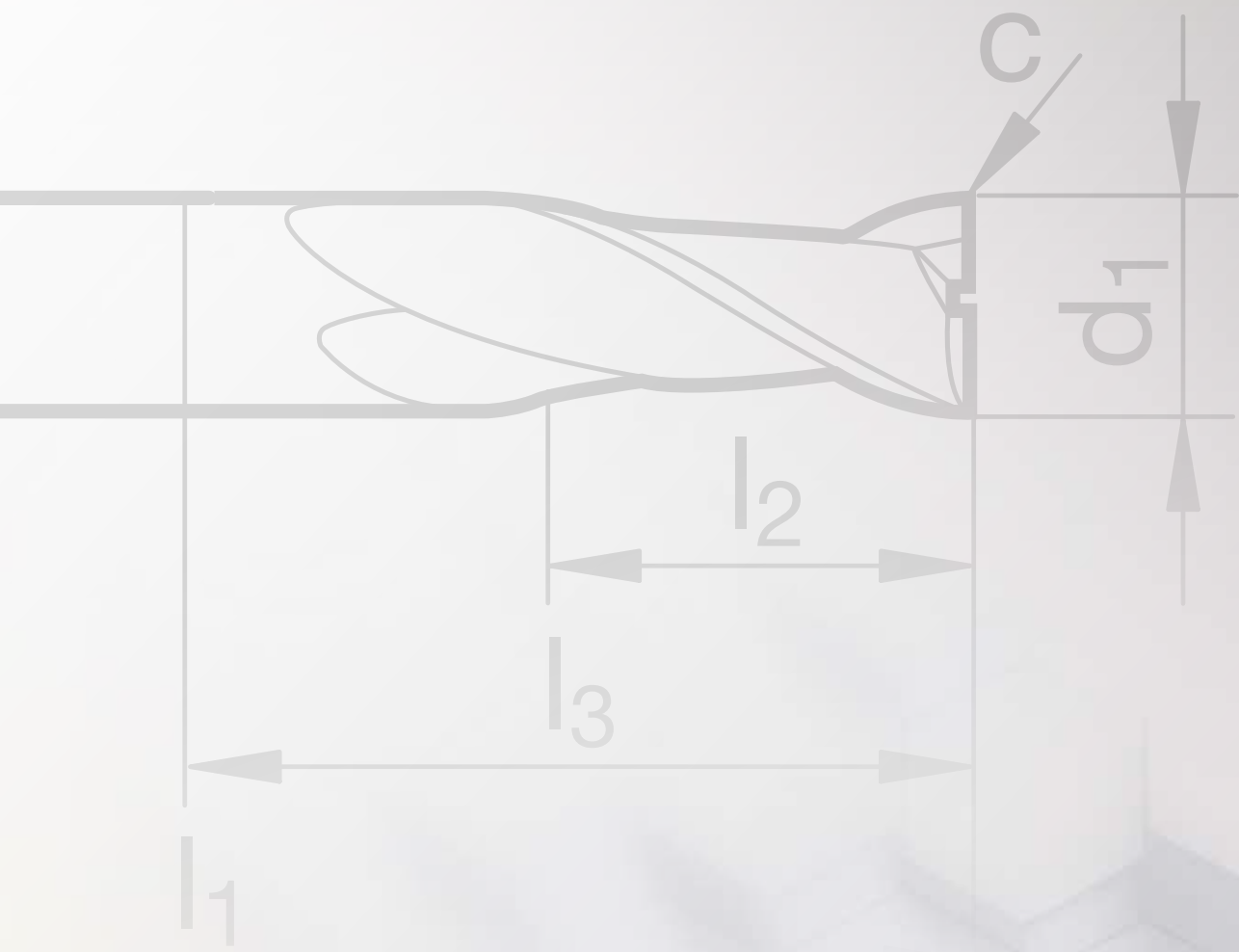

NAVIGATOR

GUHRING NAVIGATOR Milling cutters

Tools with **bold** feed column no. (FC no.) are preferred choice.

a_e = Width of cut

a_p = Depth of cut

Art. no.

Company std.
Company std.

* For large cutting depths on unstable machines f_z and v_c must be reduced or a 4-flute tool must be applied.

Cutter-Ø mm	Feed column no.															
	37	38	39	40	41	42	43	44	45	46	47	48	49	50	51	52
	f_z (mm/tooth)															
2,00	0,001	0,001	0,001	0,002	0,002	0,004	0,005	0,006	0,007	0,008	0,010	0,012	0,014	0,016	0,018	0,020
3,00	0,002	0,002	0,003	0,003	0,004	0,007	0,010	0,010	0,010	0,015	0,016	0,013	0,019	0,022	0,024	0,030
5,00	0,005	0,006	0,007	0,009	0,010	0,014	0,020	0,020	0,022	0,025	0,026	0,026	0,028	0,030	0,032	0,038
6,00	0,006	0,008	0,009	0,011	0,013	0,017	0,024	0,025	0,027	0,031	0,029	0,033	0,039	0,036	0,041	0,047
8,00	0,010	0,012	0,014	0,016	0,019	0,024	0,032	0,032	0,035	0,042	0,042	0,047	0,053	0,052	0,058	0,064
10,00	0,013	0,015	0,018	0,021	0,025	0,030	0,038	0,039	0,044	0,050	0,053	0,059	0,065	0,066	0,073	0,080
12,00	0,010	0,018	0,022	0,026	0,030	0,036	0,046	0,048	0,052	0,059	0,063	0,072	0,079	0,085	0,090	0,100
16,00	0,020	0,023	0,027	0,032	0,038	0,045	0,054	0,058	0,063	0,071	0,079	0,088	0,095	0,100	0,110	0,120
20,00	0,023	0,028	0,033	0,038	0,045	0,057	0,066	0,073	0,080	0,090	0,097	0,100	0,110	0,120	0,130	0,140
25,00	0,030	0,035	0,040	0,045	0,055	0,065	0,075	0,100	0,120	0,130	0,140	0,150	0,165	0,170	0,180	0,190

Material group	Material examples Figures in bold = material no. to DIN EN 10 027	Tensile strength MPa (N/mm ²)	Hardness
Common structural steels	1.0035 S185(St33), 1.0486 P275N(StE285), 1.0345 P235GH(H1), 1.0425 P265GH(H2)	≤500	
	1.0050 E295 (St50-2), 1.0070 E360 (St70-2), 1.8937 P500NH (WStE500)	≤1000	
Free-cutting steels	1.0718 11SMnPb30 (9SMnPb28), 1.0736 11SMn37 (9SMn36)	≤850	
	1.0727 46S20 (45S20), 1.0728 (60S20), 1.0757 46SPb20 (45SPb20)	≤1000	
Unalloyed heat-treatable steels	1.0402 C22, 1.1178 C30E (Ck30)	≤700	
	1.0503 C45, 1.1191 C45E (Ck45)	≤850	
	1.0601 C60, 1.1221 C60E (Ck60)	≤1000	
Alloyed heat-treatable steels	1.5131 50MnSi4, 1.7003 38Cr2, 1.7030 28Cr4	≤1000	
	1.5710 36NiCr6, 1.7035 41Cr4, 1.7225 42CrMo4	≤1400	
Unalloyed case hard. steels	1.0301 (C10), 1.1121 C10E (Ck10)	≤850	
Alloyed case hardened steels	1.7276 10CrMo11, 1.5125 11MnSi6	≤1000	
	1.5752 15NiCr13, 1.7131 16MnCr5, 1.7264 20CrMo5	≤1400	
Nitriding steels	1.8504 34CrAl6	≤1000	
	1.8519 31CrMoV9, 1.8550 34CrAlNi7	≤1400	
Tool steels	1.1750 C75W, 1.2067 102Cr6, 1.2307 29CrMoV9	≤850	
	1.2080 X210Cr12, 1.2083 X42Cr13, 1.2419 105WCr6, 1.2767 X45NiCrMo4	≤1400	
High speed steels	1.3243 S 6-5-2-5, 1.3343 S 6-5-2, 1.3344 S 6-5-3	≤1400	
Spring steels	1.5026 55Si7, 1.7176 55Cr3, 1.8159 51CrV4 (51CrV4)		≤350 HB
Hardened steels	-		≤48 HRC
			≤66 HRC
Stainless steels, sulphured	1.4005 X12CrS13, 1.4104 X14CrMoS17, 1.4105 X6CrMoS17, 1.4305 X8CrNiS18-9	≤900	
austenitic	1.4301 X5CrNi18-10 (V2A), 1.4541 X6CrNiTi18-10, 1.4571 X6CrNiMoTi 17-12-2 (V4A)	≤1100	
martensitic	1.4057 X20CrNi172 (X17CrNi16-2), 1.4122 X39CrMo17-1, 1.4521 X2CrMoTi18-2	≤1500	
Cast iron	0.6010 EN-GJL-100 (GG10), 0.6020 EN-GJL-200 (GG20)		≤240 HB
	0.6025 EN-GJL-250 (GG25), 0.6035 EN-GJL-350 (GG35)		≤350 HB
Spheroidal graphite iron and malleable cast iron	0.7050 EN-GJS-500-7 (GGG50), 0.8035 EN-GJMW-350-4 (GTW35)		≤240 HB
	0.7070 EN-GJS-700-2 (GGG70), 0.8170 EN-GJMB-700-2 (GTS70)		≤350 HB
Chilled cast iron	-		≤350 HB
New cast materials GGV	EN-GJV250 (GGV25), EN-GJV350 (GGV35)		≤220 HB
	EN-GJV400 (GGV40), EN-GJV500 (GGV50), SiMo 6		≤300 HB
New cast materials ADI	EN-GJS-800-8 (ADI800), EN-GJS-1000-5 (ADI1000)	≤1000	
	EN-GJS-1200-2 (ADI1200), EN-GJS-1400-1 (ADI1400)	≤1400	
Special alloys	Nimonic, Inconel, Monel, Hastelloy	≤2000	
Ti and Ti-alloys	3.7024 Ti99,5, 3.7114 TiAl5Sn2,5, 3.7124 TiCu2	≤850	
	3.7154 TiAl6Zr5, 3.7165 TiAl6V4, 3.7184 TiAl4Mo4Sn2,5, - TiAl8Mo1V1	≤1400	
Aluminium and Al-alloys	3.0255 Al99,5, 3.2315 AlMgSi1, 3.3515 AlMg1	≤400	
Al wrought alloys	3.0615 AlMgSiPb, 3.1325 AlCuMg1, 3.3245 AlMg3Si, 3.4365 AlZnMgCu1,5	≤650	
Al cast alloys ≤ 10 % Si	3.2131 G-AlSi5Cu1, 3.2153 G-AlSi7Cu3, 3.2573 G-AlSi9	≤600	
≤ 24 % Si	3.2581 G-AlSi12, 3.2583 G-AlSi12Cu, - G-AlSi12CuNiMg	≤600	
Magnesium alloys	3.5200 MgMn2, 3.5812.05 G-MgAl8Zn1, 3.5612.05 G-MgAl6Zn1	≤400	
Copper, low-alloyed	2.0070 SE-Cu, 2.1020 CuSn6, 2.1096 G-CuSn5ZnPb	≤500	
Brass, short-chipping	2.0380 CuZn39Pb2, 2.0401 CuZn39Pb3, 2.0410 CuZn43Pb2	≤600	
long-chipping	2.0250 CuZn20, 2.0280 CuZn33, 2.0332 CuZn37Pb0,5	≤600	
Bronze, short-chipping	2.1090 CuSn7ZnPb, 2.1170 CuPb5Sn5, 2.1176 CuPb10Sn	≤600	
	2.0790 CuNi18Zn19Pb	≤850	
Bronze, long-chipping	2.0916 CuAl5, 2.0960 CuAl9Mn, 2.1050 CuSn10	≤850	
	2.0980 CuAl11Ni, 2.1247 CuBe2	≤1000	
Duroplastics	Epoxy resin, Resopal, Pertinax, Moltopren	≤150	
Thermoplastics	Plexiglass, Hostalen, Novodur, Makralon	≤100	
Kevlar	Kevlar	≤1000	
Glass, carbon concentr. plastics	GFK/CFK	≤1000	

Corrections V_c and f_z

Slot milling

Roughing

	Solid carbide	Solid carbide	Solid carbide	Solid carbide	Solid carbide	Solid carbide	Solid carbide	Solid carbide
	N	N	N	N	NH	W	N	HRf
HA	19988/19962	19982/19963	19990	19984	19986	19994/19996	19980	19964/19966
HB	19989	19983	19991	19985	19987	19995/19997 19992/19993	19981	19965/19967

HPC

54HRC

54HRC



$a_e = 1 \times D$

$a_e = 1 \times D$

$a_e = 1 \times D$

$a_e = 1 \times D$

$a_e = 1 \times D$

$a_e = 1 \times D$

$a_e = 0,5-1,0 \times D$

$a_e = 0,5-1,0 \times D$

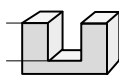
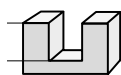
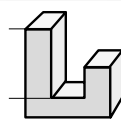
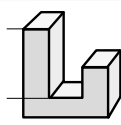
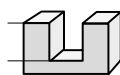
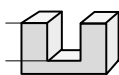

$a_p = 0,5 \times D$

$a_p = 0,5 \times D$

$a_p = 2 \times D$

$a_p = 2 \times D$

$a_p = 1 \times D$

$a_p = 1 \times D$

$a_p = 1 \times D$

$a_p = 1 \times D$

v_c m/min	Feed col. no.	v_c m/min	Feed col. no.	v_c m/min	Feed col. no.	v_c m/min	Feed col. no.	v_c m/min	Feed col. no.	v_c m/min	Feed col. no.	v_c m/min	Feed col. no.	v_c m/min	Feed col. no.
85 - 105	42	85 - 105	42	72 - 88	39	72 - 88	39	94 - 116	43			170 - 208	51		
81 - 99	41	81 - 99	41	67 - 83	38	67 - 83	38	89 - 109	42			157 - 193	50		
85 - 105	41	85 - 105	41	72 - 88	38	72 - 88	38	94 - 116	42			170 - 208	50		
63 - 77	42	63 - 77	42	54 - 66	39	54 - 66	39	69 - 85	43			126 - 154	49		
85 - 105	41	85 - 105	41	72 - 88	38	72 - 88	38	94 - 116	42			170 - 208	50		
76 - 94	41	76 - 94	41	63 - 77	38	63 - 77	38	84 - 104	42			151 - 185	50		
63 - 77	42	63 - 77	42	54 - 66	39	54 - 66	39	69 - 85	43			126 - 154	49		
76 - 94	42	76 - 94	42	63 - 77	39	63 - 77	39	84 - 104	43			151 - 185	49		
63 - 77	42	63 - 77	42	54 - 66	39	54 - 66	39	69 - 85	43			126 - 154	48	72 - 88	39
90 - 110	41	90 - 110	41	67 - 83	38	67 - 83	38	99 - 121	42			189 - 231	50		
76 - 94	41	76 - 94	41	63 - 77	38	63 - 77	38	84 - 104	42			151 - 185	50	86 - 106	41
54 - 66	42	54 - 66	42	45 - 55	39	45 - 55	39	59 - 73	43			113 - 139	49	64 - 80	40
85 - 105	41	85 - 105	41	72 - 88	38	72 - 88	38	94 - 116	42			170 - 208	50	97 - 119	41
76 - 94	40	76 - 94	40	63 - 77	37	63 - 77	37	84 - 104	41			151 - 185	48	86 - 106	39
76 - 94	41	76 - 94	41	63 - 77	38	63 - 77	38	84 - 104	42			151 - 185	50	86 - 106	41
63 - 77	40	63 - 77	40	54 - 66	37	54 - 66	37	69 - 85	41			126 - 154	48	72 - 88	39
45 - 55	42	45 - 55	42	40 - 50	39	40 - 50	39	49 - 61	43			94 - 116	49	54 - 66	47
45 - 55	40							49 - 61	41			94 - 116	48	54 - 66	26
45 - 55	40							49 - 61	41			44 - 54	46	25 - 31	38
45 - 55	42	45 - 55	42					49 - 61	43			80 - 100	49		
40 - 50	40	40 - 50	40					45 - 55	41			70 - 90	48		
36 - 44	41	36 - 44	41					39 - 49	42			65 - 70	49	43 - 53	40
108 - 132	41	108 - 132	41	94 - 116	38	94 - 116	38	118 - 146	42			220 - 270	50	126 - 154	42
99 - 121	40	99 - 121	40	85 - 105	37	85 - 105	37	108 - 134	41			201 - 247	49	115 - 141	41
90 - 110	41	90 - 110	41	81 - 99	38	81 - 99	38	99 - 121	42			182 - 224	50	104 - 128	42
81 - 99	40	81 - 99	40	67 - 83	37	67 - 83	37	89 - 109	41			157 - 193	49	90 - 110	41
54 - 66	40	54 - 66	40					59 - 73	41			107 - 131	47	61 - 75	39
27 - 33	40	27 - 33	40					29 - 37	41			56 - 70	48		
45 - 55	40	45 - 55	40	58 - 72	37	58 - 72	37	49 - 61	41			54 - 86	43		
36 - 44	40	36 - 44	40	31 - 39	37	31 - 39	37	39 - 49	41			44 - 72	42		
405 - 495	43									297 - 363	46				
495 - 605	43									360 - 440	46				
198 - 242	42							217 - 267	43	144 - 176	45				
162 - 198	43							178 - 218	44	117 - 143	46				
225 - 275	44									171 - 209	47				
108 - 132	43							118 - 146	44	81 - 99	46				
90 - 110	43							99 - 121	44	72 - 88	46			117 - 143	42
81 - 99	42									67 - 83	45				
90 - 110	42							99 - 121	43	72 - 88	45			117 - 143	42
72 - 88	41							79 - 97	42	63 - 77	44			87 - 107	41
72 - 88	42									63 - 77	45				
63 - 77	40									54 - 66	43				
108 - 132	40									81 - 99	43				
99 - 121	40									72 - 88	43				

1 x D = 75%
1,5 x D = 50%

1 x D = 75%
1,5 x D = 50%

3 x D = 50%

3 x D = 50%

1,5 x D = 50%

1,5 x D = 50%

$a_e = 1,5 \times D = 50%$ $a_e = 0,5 \times D = 120%$
 $a_p = 0,25 \times D = 150%$

GUHRING NAVIGATOR Milling cutters

Tools with **bold** feed column no. (FC no.) are preferred choice.

a_e = Width of cut

a_p = Depth of cut

Art. no

Company std.
Company std.

* For large cutting depths on unstable machines f_z and v_c must be reduced or a 4-flute tool must be applied.

Cutter-Ø mm	Feed column no.															
	37	38	39	40	41	42	43	44	45	46	47	48	49	50	51	52
	f_z (mm/tooth)															
2,00	0,001	0,001	0,001	0,002	0,002	0,004	0,005	0,006	0,007	0,008	0,010	0,012	0,014	0,016	0,018	0,020
3,00	0,002	0,002	0,003	0,003	0,004	0,007	0,010	0,010	0,010	0,015	0,016	0,013	0,019	0,022	0,024	0,030
5,00	0,005	0,006	0,007	0,009	0,010	0,014	0,020	0,020	0,022	0,025	0,026	0,026	0,028	0,030	0,032	0,038
6,00	0,006	0,008	0,009	0,011	0,013	0,017	0,024	0,025	0,027	0,031	0,029	0,033	0,039	0,036	0,041	0,047
8,00	0,010	0,012	0,014	0,016	0,019	0,024	0,032	0,032	0,035	0,042	0,042	0,047	0,053	0,052	0,058	0,064
10,00	0,013	0,015	0,018	0,021	0,025	0,030	0,038	0,039	0,044	0,050	0,053	0,059	0,065	0,066	0,073	0,080
12,00	0,010	0,018	0,022	0,026	0,030	0,036	0,046	0,048	0,052	0,059	0,063	0,072	0,079	0,085	0,090	0,100
16,00	0,020	0,023	0,027	0,032	0,038	0,045	0,054	0,058	0,063	0,071	0,079	0,088	0,095	0,100	0,110	0,120
20,00	0,023	0,028	0,033	0,038	0,045	0,057	0,066	0,073	0,080	0,090	0,097	0,100	0,110	0,120	0,130	0,140
25,00	0,030	0,035	0,040	0,045	0,055	0,065	0,075	0,100	0,120	0,130	0,140	0,150	0,165	0,170	0,180	0,190

Material group	Material examples Figures in bold = material no. to DIN EN 10 027	Tensile strength MPa (N/mm ²)	Hardness
Common structural steels	1.0035 S185(St33), 1.0486 P275N(StE285), 1.0345 P235GH(H1), 1.0425 P265GH(H2)	≤500	
	1.0050 E295 (St50-2), 1.0070 E360 (St70-2), 1.8937 P500NH (WStE500)	≤1000	
Free-cutting steels	1.0718 11SMnPb30 (9SMnPb28), 1.0736 11SMn37 (9SMn36)	≤850	
	1.0727 46S20 (45S20), 1.0728 (60S20), 1.0757 46SPb20 (45SPb20)	≤1000	
Unalloyed heat-treatable steels	1.0402 C22, 1.1178 C30E (Ck30)	≤700	
	1.0503 C45, 1.1191 C45E (Ck45)	≤850	
	1.0601 C60, 1.1221 C60E (Ck60)	≤1000	
Alloyed heat-treatable steels	1.5131 50MnSi4, 1.7003 38Cr2, 1.7030 28Cr4	≤1000	
	1.5710 36NiCr6, 1.7035 41Cr4, 1.7225 42CrMo4	≤1400	
Unalloyed case hard. steels	1.0301 (C10), 1.1121 C10E (Ck10)	≤850	
Alloyed case hardened steels	1.7276 10CrMo11, 1.5125 11MnSi6	≤1000	
	1.5752 15NiCr13, 1.7131 16MnCr5, 1.7264 20CrMo5	≤1400	
Nitriding steels	1.8504 34CrAl6	≤1000	
	1.8519 31CrMoV9, 1.8550 34CrAlNi7	≤1400	
Tool steels	1.1750 C75W, 1.2067 102Cr6, 1.2307 29CrMoV9	≤850	
	1.2080 X210Cr12, 1.2083 X42Cr13, 1.2419 105WCr6, 1.2767 X45NiCrMo4	≤1400	
High speed steels	1.3243 S 6-5-2-5, 1.3343 S 6-5-2, 1.3344 S 6-5-3	≤1400	
Spring steels	1.5026 55Si7, 1.7176 55Cr3, 1.8159 51CrV4 (51CrV4)		≤350 HB
Hardened steels	-		≤48 HRC ≤66 HRC
Stainless steels, sulphured	1.4005 X12CrS13, 1.4104 X14CrMoS17, 1.4105 X6CrMoS17, 1.4305 X8CrNiS18-9	≤900	
austenitic	1.4301 X5CrNi18-10 (V2A), 1.4541 X6CrNiTi18-10, 1.4571 X6CrNiMoTi 17-12-2 (V4A)	≤1100	
martensitic	1.4057 X20CrNi172 (X17CrNi16-2), 1.4122 X39CrMo17-1, 1.4521 X2CrMoTi18-2	≤1500	
Cast iron	0.6010 EN-GJL-100 (GG10), 0.6020 EN-GJL-200 (GG20)		≤240 HB
	0.6025 EN-GJL-250 (GG25), 0.6035 EN-GJL-350 (GG35)		≤350 HB
Spheroidal graphite iron and malleable cast iron	0.7050 EN-GJS-500-7 (GGG50), 0.8035 EN-GJMW-350-4 (GTW35)		≤240 HB
	0.7070 EN-GJS-700-2 (GGG70), 0.8170 EN-GJMB-700-2 (GTS70)		≤350 HB
Chilled cast iron	-		≤350 HB
New cast materials GGV	EN-GJV250 (GGV25), EN-GJV350 (GGV35)		≤220 HB
	EN-GJV400 (GGV40), EN-GJV500 (GGV50), SiMo 6		≤300 HB
New cast materials ADI	EN-GJS-800-8 (ADI800), EN-GJS-1000-5 (ADI1000)	≤1000	
	EN-GJS-1200-2 (ADI1200), EN-GJS-1400-1 (ADI1400)	≤1400	
Special alloys	Nimonic, Inconel, Monel, Hastelloy	≤2000	
Ti and Ti-alloys	3.7024 Ti99,5, 3.7114 TiAl5Sn2,5, 3.7124 TiCu2	≤850	
	3.7154 TiAl6Zr5, 3.7165 TiAl6V4, 3.7184 TiAl4Mo4Sn2,5, - TiAl8Mo1V1	≤1400	
Aluminium and Al-alloys	3.0255 Al99,5, 3.2315 AlMgSi1, 3.3515 AlMg1	≤400	
Al wrought alloys	3.0615 AlMgSiPb, 3.1325 AlCuMg1, 3.3245 AlMg3Si, 3.4365 AlZnMgCu1,5	≤650	
Al cast alloys ≤ 10 % Si	3.2131 G-AlSi5Cu1, 3.2153 G-AlSi7Cu3, 3.2573 G-AlSi9	≤600	
≤ 24 % Si	3.2581 G-AlSi12, 3.2583 G-AlSi12Cu, - G-AlSi12CuNiMg	≤600	
Magnesium alloys	3.5200 MgMn2, 3.5812.05 G-MgAl8Zn1, 3.5612.05 G-MgAl6Zn1	≤400	
Copper, low-alloyed	2.0070 SE-Cu, 2.1020 CuSn6, 2.1096 G-CuSn5ZnPb	≤500	
Brass, short-chipping	2.0380 CuZn39Pb2, 2.0401 CuZn39Pb3, 2.0410 CuZn43Pb2	≤600	
long-chipping	2.0250 CuZn20, 2.0280 CuZn33, 2.0332 CuZn37Pb0,5	≤600	
Bronze, short-chipping	2.1090 CuSn7ZnPb, 2.1170 CuPb5Sn5, 2.1176 CuPb10Sn	≤600	
	2.0790 CuNi18Zn19Pb	≤850	
Bronze, long-chipping	2.0916 CuAl5, 2.0960 CuAl9Mn, 2.1050 CuSn10	≤850	
	2.0980 CuAl11Ni, 2.1247 CuBe2	≤1000	
Duroplastics	Epoxy resin, Resopal, Pertinax, Moltopren	≤150	
Thermoplastics	Plexiglass, Hostalen, Novodur, Makralon	≤100	
Kevlar	Kevlar	≤1000	
Glass, carbon concentr. plastics	GFK/CFK	≤1000	

Corrections V_c and f_z

	Finishing		Fine finishing		Copying	
	Solid carbide	Solid carbide	Solid carbide	Solid carbide	Solid carbide	Solid carbide
	N	N	NH	NH	N	N
HA	19978/19961	19976	19972	19974*	19968	19970
HB	19979	19977	19973	19975*	19969	19971



$a_e = 0,1 \times D$



$a_p = 1 \times D$



$a_e = 0,1 \times D$

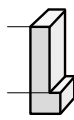

$a_p = 2 \times D$



$a_e = 0,05 \times D$



$a_p = 1,5 \times D$



$a_e = 0,05 \times D$



$a_p = 3 \times D$



$a_e = 0,05 \times D$

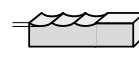

$a_p = 0,05 \times D$



$a_e = 0,05 \times D$

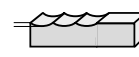

$a_p = 0,05 \times D$

V_c m/min	Feed col. no.	V_c m/min	Feed col. no.	V_c m/min	Feed col. no.	V_c m/min	Feed col. no.	V_c m/min	Feed col. no.	V_c m/min	Feed col. no.
157 - 193	48	103 - 127	43	171 - 209	48	136 - 168	45	153 - 187	48	153 - 187	46
144 - 176	47	94 - 116	42	157 - 193	47	126 - 154	44	144 - 176	47	144 - 176	45
157 - 193	47	103 - 127	42	171 - 209	47	136 - 168	44	153 - 187	47	153 - 187	45
117 - 143	46	81 - 99	41	126 - 154	46	100 - 124	43	153 - 187	46	153 - 187	44
157 - 193	47	103 - 127	42	171 - 209	47	136 - 168	44	135 - 165	47	135 - 165	45
144 - 176	47	90 - 110	42	153 - 187	47	122 - 150	44	135 - 165	47	135 - 165	45
117 - 143	46	76 - 94	41	126 - 154	46	100 - 124	43	117 - 143	46	117 - 143	44
139 - 171	46	90 - 110	41	153 - 187	46	122 - 150	43	126 - 154	46	126 - 154	44
117 - 143	45	76 - 94	40	126 - 154	45	100 - 124	42	153 - 187	45	153 - 187	43
175 - 215	47	99 - 121	42	189 - 231	47	151 - 185	44	198 - 242	47	198 - 242	45
139 - 171	47	90 - 110	42	153 - 187	47	122 - 150	44	171 - 209	47	171 - 209	45
103 - 127	46	67 - 83	41	117 - 143	46	93 - 115	43	108 - 132	46	108 - 132	44
157 - 193	47	103 - 127	42	171 - 209	47	136 - 168	44	144 - 176	47	144 - 176	45
144 - 176	45	90 - 110	40	153 - 187	45	122 - 150	42	135 - 165	45	135 - 165	43
139 - 171	47	90 - 110	42	153 - 187	47	122 - 150	44	135 - 165	47	135 - 165	45
117 - 143	45	76 - 94	40	126 - 154	45	100 - 124	42	117 - 143	45	117 - 143	43
90 - 110	46	58 - 72	41	94 - 116	46	75 - 93	43	85 - 105	46	85 - 105	44
				94 - 116	45	75 - 93	42	85 - 105	45	85 - 105	43
				49 - 61	43	39 - 49	41	49 - 61	44	49 - 61	42
90 - 110	46			94 - 116	46	75 - 93	43	85 - 105	46	85 - 105	44
76 - 94	45			81 - 99	45	64 - 80	42	76 - 94	45	76 - 94	43
72 - 88	46			76 - 94	46	61 - 75	43	67 - 83	46	67 - 83	44
189 - 231	47	135 - 165	42	220 - 270	47	132 - 162	44	198 - 242	47	198 - 242	45
189 - 231	46	121 - 149	41	202 - 248	46	121 - 149	43	189 - 231	46	189 - 231	44
171 - 209	47	112 - 138	42	180 - 220	47	108 - 132	44	171 - 209	47	171 - 209	45
144 - 176	46	94 - 116	41	157 - 193	46	94 - 116	41	144 - 176	46	144 - 176	44
99 - 121	44							99 - 121	44	99 - 121	42
54 - 66	45			54 - 66	45	32 - 40	42	49 - 61	45	49 - 61	43
90 - 110	45	58 - 72	40	94 - 116	45	56 - 70	42				
72 - 88	44	45 - 55	39	76 - 94	44	45 - 57	41				
765 - 935	50	450 - 550	45	810 - 990	50	486 - 594	41	720 - 880	50	720 - 880	48
				720 - 880	50	432 - 528	41	855 - 1045	50	855 - 1045	48
373 - 457	48	225 - 275	43	405 - 495	48	243 - 297	45	342 - 418	48	342 - 418	46
306 - 374	49	180 - 220	44	324 - 396	49	194 - 238	46	288 - 352	49	288 - 352	47
				450 - 550	50			405 - 495	50	405 - 495	48
198 - 242	49	135 - 165	44	216 - 264	49			180 - 220	49	180 - 220	47
180 - 220	48	108 - 132	43	198 - 242	48	118 - 146	45	171 - 209	48	171 - 209	46
144 - 176	48	90 - 110	43	162 - 198	48			162 - 198	48	162 - 198	46
180 - 220	48	108 - 132	43	198 - 242	48	118 - 146	45	180 - 220	48	180 - 220	46
135 - 165	47			153 - 187	47	91 - 113	44	171 - 209	47	171 - 209	45
				153 - 187	47			198 - 242	47	198 - 242	45
				126 - 154	46	75 - 93	43	189 - 231	46	189 - 231	44
				216 - 264	46						
				198 - 242	46						

$a_p 2 \times D = 50\%$

$a_p 3 \times D = 50\%$

$a_p 0,1 \times D = 75\%$

Guhring's tool dispensing systems TM 326, TM 426 and TM 526 optimise your tool storage and your tool management. Gain increased security of your tool stock and increase the transparency of your tool management!



GUHRING



Tool Management
Powered by

GÜHRING

GM 300 | GÜHROJET |

Tool holders with peripheral cooling



Further tool holders
can be found in our
GM 300 catalogue.

ISO code

P	Steel, high-alloyed steel
M	Stainless steel Stainless
K	Grey cast iron, spher, graphite/mall. cast iron
N	Aluminium and other non-ferrous metals
S	Special, super and titanium alloys
H	Hardened steel and chilled cast iron







































On the following price and programme pages you will find for every tool recommendations regarding suitability for the application groups and details of max. tensile strength and hardness:

- optimal suitability
- limited suitability

Coatings

○ bright	● A TiAlN	● P AlCrN	● S Sirius	● Y Signum
○ steam tempered	● C TiCN	● S TiN	● F FIRE/nano FIRE	
● nitrided	● Cb Carbo	● M MolyGlide	● a TiAlN nanoA	

Pictograms

Tool material	VHM						
	Solid carbide finest grain (HM-UF)						
Shank form							
	to DIN 6535						
Standard							
	to DIN	to Guhring standard					
Type	N	W	NH	HRf			
Application							
	Slotting	Roughing	Ramping	Helix	Drilling	Finishing	Copying
Length							
	short (DIN)	long (DIN)	medium	extra length			
No. of cutting edges							
	no. of major cutting edges						
Helix angle							
	Size of helix angle / no. of different helix angles						
Rake angle							
	Rake angle of circumference cutting edges						
Cutting edge form							
	Corner chamfer	Radius with tolerance					
Feed							
	for lateral feed	for lateral feed and oblique plunging	for lateral feed, oblique plunging and drilling				

Drilling



Tapping/thread milling/fluteless tapping

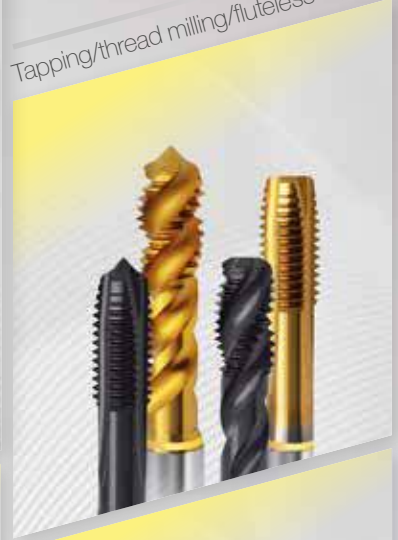

Milling



Countersinking de-burring



PCD



Reaming

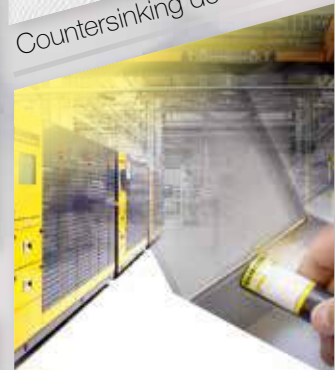

Tool restoration service



Special tooling solutions

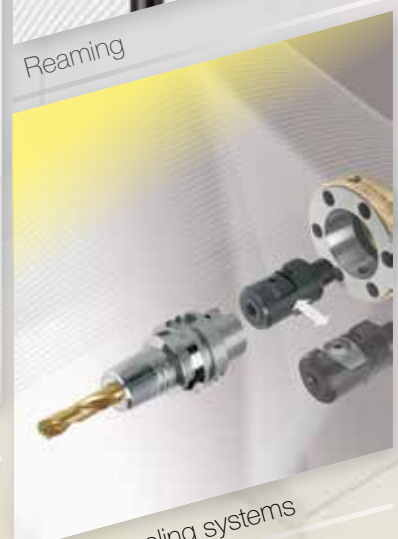

Modular tooling systems

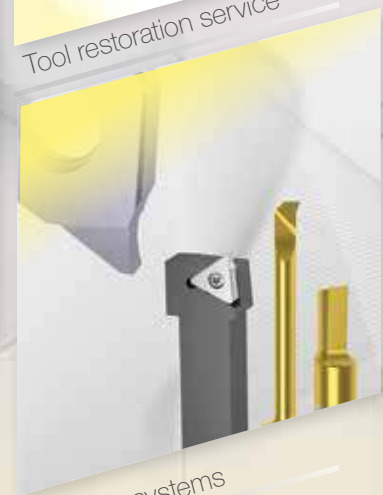

Grooving systems

GUHRING KG

Telephone: +49 74 31 17-0 | Fax: +49 74 31 17 - 21 279

Herderstrasse 50 - 54 | 72458 Albstadt | Germany | info@guehring.de | www.guehring.de

No liability can be accepted for printing errors or technical changes of any kind.
Our Conditions of Sale and Terms of Payment apply. Available on request.
All prices are excluding VAT, price list 45 of January 2018.