



ALLIED MACHINE & ENGINEERING

Holemaking Solutions for Today's Manufacturing



Boring



Reaming



Burnishing



Threading



Specials



APX™ Drill

▶ **DRILLING**

Deep Hole / Large Diameter Drilling System

North America

Allied Machine

120 Deeds Drive
Dover, OH 44622
United States

Allied Machine

485 West 3rd Street
Dover, OH 44622
United States

ThreadMills USA™

4185 Crosstowne Ct #B
Evans, GA 30809
United States

Superion™

1285 S Patton St.
Xenia, OH 45385
United States

Europe

Allied Machine Europe

93 Vantage Point
Pensnett Estate
Kingswinford
West Midlands
DY6 7FR, United Kingdom

Wohlhaupter® GmbH

Maybachstrasse 4
Postfach 1264
72636 Frickenhausen
Germany

Asia

Wohlhaupter® India

B-23, 2nd Floor
B Block Community Centre
Janakpuri, New Delhi - 110058
India



Allied Machine & Engineering is a worldwide leader in holmaking and finishing solutions. We are committed to providing practical and dependable solutions to our customers through innovative designs and superior customer and technical support.

We continue to expand our product offering in order to provide new and different solutions. With Field Sales Engineers located around the world, we position ourselves to provide technical support on site, right at your spindle.



ALLIED MACHINE
& ENGINEERING

www.alliedmachine.com



ALLIED MACHINE & ENGINEERING

Holemaking Solutions for Today's Manufacturing

APX™ Drill

The Foundation

Since 1941, Allied Machine & Engineering has provided dependable and practical holemaking solutions to the world. What was once a small job shop in Ohio is now a worldwide leader in cutting tool technology. With three manufacturing facilities in Ohio, one in Georgia, another in Germany, and headquarters in both the United States and Europe, Allied Machine is positioned to bring innovative solutions and technical expertise directly to the customers' hands.



The Beginning

Harold E. Stokey founded Allied Machine & Engineering to aid the war effort, manufacturing taper bearing lock nuts for the production of M1 tanks. Years later, after a sales meeting gone wrong, Stokey possessed a warehouse stocked with spade drill inserts. He set forth into the industry that would become Allied Machine's thriving identity: holemaking.



The T-A®

When Harold's son, William H. Stokey, became the president and CEO, he developed the Throw Away, or T-A, spade drill insert system. The T-A revolutionized the holemaking industry, launching Allied Machine ahead of the competition. Since then, numerous innovations and advancements have been created from the T-A's inspiration.



The Innovation

Since the development of the T-A, Allied Machine has expanded its product offering to support a vast range of customer applications, including large diameter and deep hole drilling, boring, reaming, burnishing, porting, and threading.

The People

Allied Machine understands that high quality products are only one facet of success. Our customer support is crucial to what we do, and that's why we make sure the best engineers and customer service associates are in place to assist our customers around the world.

The Future

With over 75 years of experience, Allied Machine has encountered the challenges of growth and success. By investing in cutting edge technology and the brightest and sharpest minds, our knowledge and capabilities continue to expand and grow every day.



Steve Stokey
Executive Vice President

William H. Stokey
President and CEO

Mike Stokey
Executive Vice President



WOHLHAUPTER®



SUPERION™

CRITERION™

Replaceable Insert Drills

- Reduce costs by decreasing set-up time and utilizing a single holder for the lives of multiple inserts
- Provide flexibility to quickly switch between inserts with different geometries
- Products:
 - GEN3SYS® XT | GEN3SYS® XT Pro
 - Original T-A® | GEN2 T-A®
 - High Performance | Universal



Indexable Insert Drills

- Protect your investment and reduce your inventory with replaceable cartridges that allow the same holder to be used repeatedly
- Indexable inserts increase productivity and tool life while reducing costs
- Products:
 - 4TEX® Drill
 - Revolution Drill®
 - Opening Drill®



Replaceable / Indexable Insert Drills

- Allow for higher spindle speeds and take advantage of the power curve on modern CNC machines
- Achieve maximum penetration rates in deep hole drilling applications
- Holders cover a range of sizes with the replaceable heads determining the cutting diameter
- Products:
 - APX™ Drill



Solid Carbide Drills

- Offer greater strength and stability when drilling tougher materials
- Available in diameters from 3mm - 20mm
- Can be made-to-order specifically for your application (Superion™ quoted specials)
 - ASC 320®
 - Superion™



Structural Steel Solutions



- Deliver outstanding performance and durability in structural steel applications
- Designed to produce optimal results in difficult-to-machine materials
- Available in multiple lengths and diameters
- T-A® style drills have different insert geometry options to improve performance depending on material
- Products:
 - **Original T-A®** | **GEN2 T-A®**
 - **GEN3SYS® XT Pro**

BTA (STS) Machining Solutions

- The internal ejection system flushes chips and debris from the hole with no interference to the cutting process
- Utilizes the advantages of the T-A® drill insert
- Designed to significantly increase penetration rates over brazed heads and traditional gun drills
- Products:
 - **BT-A Drill**



Hydraulic Port Contour Cutters



- Save significant time and money by performing four processes in one step
- Replaceable insert design reduces costs, inventory, and set-up times
- Available in 4 industry specifications:
 - Imperial: SAE J-1926
 - Metric: ISO 6149-1:2006
 - Military: SAE AS5202
 - John Deere: JDS-G173.1
- Products:
 - **AccuPort 432®**



Enhanced Special Drilling Capabilities

- Allied Machine Engineers are available to meet with you to evaluate your application and recommend the best solution for you
- Special drilling solutions can incorporate advanced features such as adjustable diameter locations, multiple steps, additional coolant designs, special lengths and diameters, and more
- Special drills can drastically reduce your cost-per-hole and increase your overall productivity by eliminating multiple processes and increasing tool life



WOHLHAUPTER® High Precision Boring Systems

- Designs available for high volume applications that increase rigidity to improve performance
- Versatile boring heads that are flexible with changing applications while maintaining excellent performance
- Provides high precision with absolute repeatability to ensure every part is held to tolerance
- Offers an industry leading modular shank connection that maintains rigidity and reduces inventory on your boring system
- Available with both digital and analog settings
- Products:
 - Wohlhaupter® Boring Tools



CRITERION® Modular Boring Systems

- The modular capabilities are ideal for use across multiple different projects
- Offers versatile boring heads suitable for all job shops and tooling rooms
- Provides an economical solution for low volume and/or short-term production applications
- Offers both rough and finish boring solutions
- Products:
 - Criterion® Boring Tools

S.C.A.M.I.®

Expandable Reaming Solutions

- Expandable cutting diameters accommodate for wear, which extends tool life
- Replaceable cutting heads and rings reduce waste and improve production time versus solid high speed steel and carbide reamers
- Hold tight tolerances to ensure processes are performed to accurate specifications
- Reduce tooling costs because many items are available for recondition
- Products:
 - ALVAN® Reamers

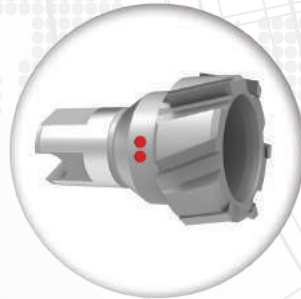

S.C.A.M.I.®

Roller Burnishing Solutions

- Produce excellent surface finishes
- Provide accurate size control
- Increase surface hardness
- Solutions for both through hole and blind hole applications
- Products:
 - S.C.A.M.I.® Roller Burnishing Tools





Solid Carbide Thread Mills

- Available with coolant through options
- Cover a wide range of thread forms
- Provide optimal solutions for both high production projects and short-run applications
- Products
 - AccuThread™ 856
 - AccuThread™ T3
 - ThreadMills USA™



Replaceable Insert Thread Mills

- 3 insert lengths are available that cover a wide range of thread forms
- Holders can utilize inserts with different pitches and thread forms
- Repeatability is achieved by both the bolt-in style and the pin style locking systems
- Increase tool life by 25 - 50% with Allied Machine's AM210® coating
- Products
 - AccuThread™ 856: Bolt-in Style
 - AccuThread™ 856: Pin Style



SPECIAL CAPABILITIES

When it comes to designing and developing special solutions for customers, Allied Machine is the top choice. If your application requires special tooling, give us a call. Our engineered specials are developed by the brightest engineers in the industry. Most of our standard tooling can be altered as specials, or we can create entirely new concepts for particularly unique applications.

One special tooling solution is Insta-Quote®, the online system that allows you to design your own special tooling 24/7. Receive a quote and drawings within minutes just by following the steps.

And with the addition of Superior™ technology and capabilities, we can customize made-to-order solid carbide tools to achieve optimal results for your applications.

Whatever your application, Allied Machine has the answer.



Insta-Quote® 

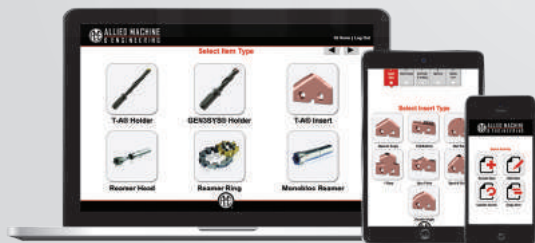

 SUPERION™



ToolMD™

Increase the production and success of your applications today.

- Offers direct access to 2D drawings and 3D models
- Assemble and view tool images in your browser
- Download drawings for use in most machining software programs
- Browse products, search item numbers, and save assemblies for future use



toolmd.com

WOHLHAUPTER® Tool-Architect

Find the right Wohlhaupter® solution for your application.

- Configure your complete tool assembly
- Compile an order list to be quoted
- Search and quickly find components using various criteria
- Adjust your language and measurement preferences



tool-architect.com

WOHLHAUPTER® Boring Insert Selector

Find the best insert for your application.

- Generate the correct boring insert for your job in just six easy steps
- Choose type, shape, substrate, insert form, nose radius, and material
- Easily order by adding the item to your cart

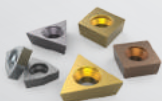

www.alliedmachine.com/bis

Product Selector

Use the product selector to find the right tool for your application.

- Guides you through steps to generate the right tool for your application
- Learn about your recommended tool and how to maximize its performance



www.alliedmachine.com/productselector

Insta-Code®

Eliminate the wait. Get your program now.

- Choose the best thread mill for your application
- Create program code for your machine
- Available as a PC download app (that can be used offline)
- Website app available 24/7



Insta-Code also has a **Cycle Time Calculator**

alliedmachine.com/InstaCode

Insta-Quote®

Design your custom tooling and receive a drawing and quote...all within minutes.

- Design and quote your own tooling
- Guides you through steps to generate the solution you need
- Features the following products
 - T-A® Inserts
 - T-A® Holders
 - GEN3SYS® XT Holders
 - ALVAN® Reamers



iq.alliedmachine.com

Solution Hub App

All Allied all the time.

- Quickly look up product information
- Links to our free online tools
- Distributor locator
- Stay up to date on news and events



Machinist Tool App

Quickly convert cutting tool parameters for the machine inputs you need.

- Input data to calculate the RPM and speed and feed rates
- Also features the Boring Insert Selector
- Access product literature right at your fingertips

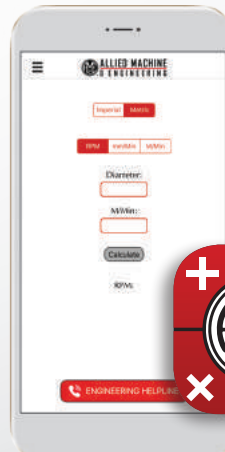

APX™ Drill

Deep Hole / Large Diameter Drilling System

► Diameter Range: 1.2992" - 4.0000" (33.00mm - 101.60mm)



Don't Let Your Machine Slow You Down

The APX deep hole/large diameter drilling system delivers the strength and versatility needed for any deep hole drilling application. The breakthrough geometry is designed to increase penetration rates and tool life. By allowing for higher spindle speeds, the APX lets you take advantage of the power curve on modern CNC machines.

Excellent chip control	Improves hole quality and surface finish	Provides maximum durability and stability
------------------------	--	---

Applicable Industries

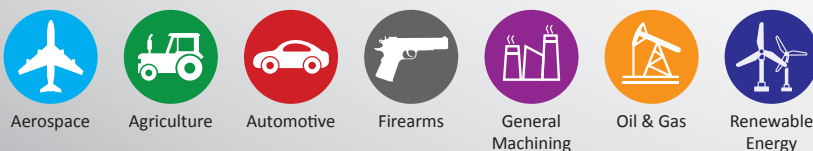

Your safety and the safety of others is very important. This catalog contains important safety messages. Always read and follow all safety precautions.



This triangle is a safety hazard symbol. It alerts you to potential safety hazards that can cause tool failure and serious injury.

When you see this symbol in the catalog, look for a related safety message that may be near this triangle or referred to in the nearby text.

There are safety signal words also used in the catalog. Safety messages follow these words.

WARNING

WARNING (shown above) means that failure to follow the precautions in this message could result in tool failure and serious injury.

NOTICE means that failure to follow the precautions in this message could result in damage to the tool or machine but not result in personal injury.

NOTE and **IMPORTANT** are also used. These are important that you read and follow but are not safety-related.

Visit www.alliedmachine.com for the most up-to-date information and procedures.

Reference Icons

The following icons will appear throughout the catalog to help you navigate between products.



Setup / Assembly Information
Detailed instructions and information regarding the corresponding part(s)

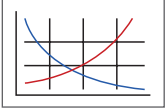

Recommended Cutting Data
Speed and feed recommendations for optimum and safe drilling

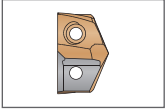

GEN3SYS® Pilot Inserts
Lists the GEN3SYS XT pilot insert options for each APX Drill series

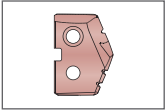

T-A® Pilot Inserts
Lists the Original T-A® and GEN2 T-A® pilot insert options for each APX Drill series

Series	Diameter Range	
	Imperial (inch)	Metric (mm)
33	1.2992 - 1.4960	33.00 - 37.99
38	1.4691 - 1.7322	38.00 - 43.99
44	1.7323 - 2.0078	44.00 - 50.99
51	2.0079 - 2.2440	51.00 - 56.99
57	2.2441 - 2.4802	57.00 - 62.99
63	2.4803 - 2.7558	63.00 - 69.99
70	2.7559 - 2.9920	70.00 - 75.99
76	2.9921 - 3.2676	76.00 - 82.99
83	3.2677 - 3.5038	83.00 - 88.99
89	3.5039 - 3.7401	89.00 - 94.99
95	3.7402 - 4.0000	95.00 - 101.60

Introduction Information

Drill Selection Guide / Assembly Details 2 - 3
 Pilot Insert Options / Details 4
 Product Nomenclature 5

















Drill Series

33 Series 6 - 7
 38 Series 8 - 9
 44 Series 10 - 11
 51 Series 12 - 13
 57 Series 14 - 15
 63 Series 16 - 17
 70 Series 18 - 19
 76 Series 20 - 21
 83 Series 22 - 23
 89 Series 24 - 25
 95 Series 26 - 27

Recommended Cutting Data

Imperial (inch) 28
 Metric (mm) 29
 Deep Hole Drilling Guidelines 30

Drill Selection Guide

Series	33	38	44	51	57
					
Page	6 - 7	8 - 9	10 - 11	12 - 13	14 - 15
D ₅ inch	1.2992 - 1.4960	1.4691 - 1.7322	1.7323 - 2.0078	2.0079 - 2.2440	2.2441 - 2.4802
D ₅ mm	33.00 - 37.99	38.00 - 43.99	44.00 - 50.99	51.00 - 56.99	57.00 - 62.99
ISO Material					
IC Insert Shape					
IC Insert Size	5/16"	3/8"	3/8", 1/2"	1/2", 9/16"	9/16"
Wear Pads	NO	NO	NO	NO	NO
Holders					
Drill Depth (inch)	4-7/16 - 14-29/32	5-1/8 - 17-1/4	6 - 20-1/8	6-3/8 - 22-3/8	7-1/8 - 24-3/4
Drill Depth (mm)	112.6 - 378.6	130.5 - 439.9	151.5 - 510.0	161.8 - 570.0	179.9 - 626.9
Pilot Insert					
T-A Series	0, 1	0, 1	1	1	1, 2
GEN3SYS XT Series	16, 18, 20	15, 17, 18, 20	17, 18, 22	18, 20, 22	22, 24, 26

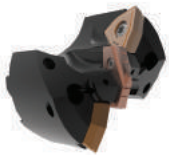

T-A® Style Pilot Insert Head

- Utilizes both Original T-A® and GEN2 T-A® inserts (0 - 2 series)
- Multiple geometry options are available to achieve optimal results in different types of applications



GEN3SYS® XT Style Pilot Insert Head

- Utilizes GEN3SYS® XT inserts (15 - 32 series)
- Multiple geometry options are available to achieve optimal results in different types of applications



IC Insert AM300®

- The design allows for excellent chip control and aggressive penetration rates
- The proprietary AM300® coatings increase tool life above competitors' premium coatings

Insert Application Recommendations

Carbide Grade Options

C5 (P35)	General purpose carbide grade suitable for most applications. ▶ <i>Common application in steels and stainless steels.</i>
C1 (K35)	Toughest carbide grade. Provides the best combination of edge strength and tool life. ▶ <i>Recommended for less rigid applications.</i>
C2 (K25)	Higher wear resistant carbide suitable for abrasive material applications. ▶ <i>Recommended for grey, ductile, and nodular irons.</i>

Additional Geometry Option

High Rake (HR)	Provides superior chip control and tool life in long chipping carbon and alloy steels below 200 Bhn.
----------------	--



Flanged Straight Shank



CAT40 / CAT50 Integral Shank

63	70	76	83	89	95
					
16 - 17	18 - 19	20 - 21	22 - 23	24 - 25	26 - 27
2.4803 - 2.7558	2.7559 - 2.9920	2.9921 - 3.2676	3.2677 - 3.5038	3.5039 - 3.7401	3.7402 - 4.0000
63.00 - 69.99	70.00 - 75.99	76.00 - 82.99	83.00 - 88.99	89.00 - 94.99	95.00 - 101.60
					
					
9/16"	3/8"	1/2"	1/2"	9/16"	9/16"
NO	YES	YES	YES	YES	YES
7-7/8 - 27-1/8	8-3/4 - 27-7/8	9-1/2 - 26-1/8	10-1/8 - 27-3/4	10-7/8 - 27-5/8	11-7/8 - 27-1/2
200.8 - 688.3	218.8 - 709.4	239.9 - 664.0	257.8 - 704.9	275.8 - 701.8	302.0 - 698.5
2	2	2	2	2	2
26, 29, 32	29	29	32	29	32



Step 1:

Lower the APX head assembly onto the APX holder.



Step 2:

Insert the head mounting screws into points A and B. Tighten until the head is properly secured to the holder.

Step 3:

Tighten with the head mounting driver using the torque setting chart below.

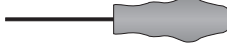
Torque Setting Chart

Series	Screw	Driver	Torque
33 - 63	75020-IP20-1	 8IP-20	60 in-lb (678 N-cm)
70 - 95	78027-IP30-1	 8IP-30B	250 in-lb (2825 N-cm)



Pilot Insert Options

A DRILLING
B BORING
C REAMING
D BURNISHING
E THREADING
X SPECIALS

T-A® Pilot Inserts

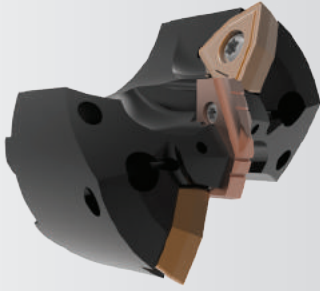

GEN3SYS® XT Pilot Inserts

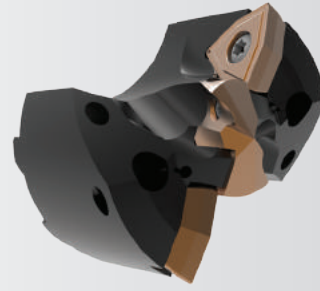

GEN2 T-A Standard

- Designed for rigid machining applications, primarily used for drilling exotic and high alloy materials
- Ideal for general use when the surface speed needs to be increased

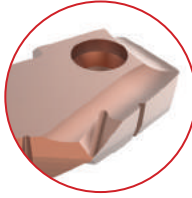

Standard Geometry

- Designed with corner and cutting edge enhancements to deliver more reliability, durability, and productivity
- Increases penetration rates and tool life
- Available in C1 or C2 carbide

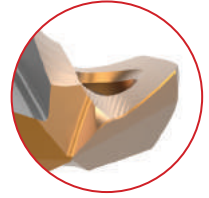

GEN2 T-A High Efficiency (-HE)

- Designed for improved chip formation in elastic materials like low carbon steels
- Maximizes performance and increases value

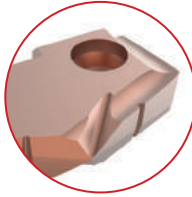

Cast Iron Geometry (-CI)

- Increases durability and tool life in ductile, nodular, and grey cast irons
- Available in C2 carbide

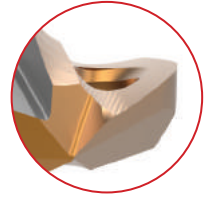

Original T-A Standard

- Excellent choice for general purpose use
- Provides fast penetration rates that produce good hole size and finish
- Combines highly efficient, stable cutting action to minimize power consumption

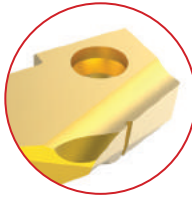

Low Rake Geometry (-LR)

- The toughest XT geometry available
- Designed for harder steels and less than ideal machining applications
- Available in C1 or C2 carbide

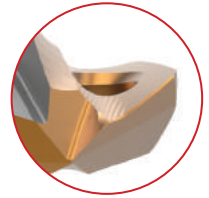

Original T-A Tiny Chip (-TC)

- Unique lip and point design for excellent chip control
- Improved capabilities in long-chipping materials such as low carbon steels and soft alloy steels
- Enhanced performance in lower powered machines for better chip formation at lower feed rates

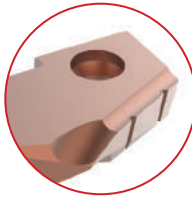

Stainless Steel Geometry (-AS)

- Designed with a specific geometry to provide unmatched chip control and tool life in austenitic and PH stainless steels, as well as high temperature alloys such as Inconel, Hastelloy, and Titanium alloys
- Available in C2 carbide



Original T-A High Impact (-HI)

- Designed to enhance chip formation in materials with high elasticity/ductility and poor chip forming characteristics
- SK2 corner preparation for increased tool life
- Improves chip formation in structural, cast, and forged steels

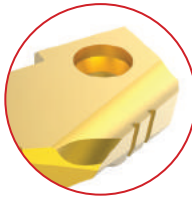

NOTE: For a complete offering of pilot inserts, see sections **A20** (GEN3SYS Drilling Systems) and **A30** (T-A Drilling Systems) of our catalog.

Product Nomenclature

APX Drill Heads

V	38	15	D	-	0116
1	2	3	4		5

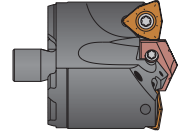

1. APX Head	2. Series	3. Pilot Series																														
V = Head	<table border="0"> <tr> <td>33 = 33 series</td> <td>70 = 70 series</td> </tr> <tr> <td>38 = 38 series</td> <td>76 = 76 series</td> </tr> <tr> <td>44 = 44 series</td> <td>83 = 83 series</td> </tr> <tr> <td>51 = 51 series</td> <td>89 = 89 series</td> </tr> <tr> <td>57 = 57 series</td> <td>95 = 95 series</td> </tr> <tr> <td>63 = 63 series</td> <td></td> </tr> </table>	33 = 33 series	70 = 70 series	38 = 38 series	76 = 76 series	44 = 44 series	83 = 83 series	51 = 51 series	89 = 89 series	57 = 57 series	95 = 95 series	63 = 63 series		<table border="0"> <tr> <th>T-A® Pilot Insert</th> <th colspan="2">GEN3SYS® XT Pilot Insert</th> </tr> <tr> <td>00 = 0 series</td> <td>15 = 15 series</td> <td>24 = 24 series</td> </tr> <tr> <td>01 = 1 series</td> <td>17 = 17 series</td> <td>26 = 26 series</td> </tr> <tr> <td>02 = 2 series</td> <td>18 = 18 series</td> <td>29 = 29 series</td> </tr> <tr> <td></td> <td>20 = 20 series</td> <td>32 = 32 series</td> </tr> <tr> <td></td> <td>22 = 22 series</td> <td></td> </tr> </table>	T-A® Pilot Insert	GEN3SYS® XT Pilot Insert		00 = 0 series	15 = 15 series	24 = 24 series	01 = 1 series	17 = 17 series	26 = 26 series	02 = 2 series	18 = 18 series	29 = 29 series		20 = 20 series	32 = 32 series		22 = 22 series	
33 = 33 series	70 = 70 series																															
38 = 38 series	76 = 76 series																															
44 = 44 series	83 = 83 series																															
51 = 51 series	89 = 89 series																															
57 = 57 series	95 = 95 series																															
63 = 63 series																																
T-A® Pilot Insert	GEN3SYS® XT Pilot Insert																															
00 = 0 series	15 = 15 series	24 = 24 series																														
01 = 1 series	17 = 17 series	26 = 26 series																														
02 = 2 series	18 = 18 series	29 = 29 series																														
	20 = 20 series	32 = 32 series																														
	22 = 22 series																															

4. Effective Cutting	5. Major Diameter
D = Double effective S = Single effective	0116 = Inch 1.5153 = Decimal 68 = Metric

Ordering Non-Stocked Diameters:

Non-stocked diameters are also available. Please refer to the price list for applicable process fees. Follow the ordering examples below:

- Inch: 38 series, T-A (1 series), 1.6790" = **V3801D-1.6790**
- Metric: 38 series, T-A (1 series), 42.15mm = **V3801D-42.15**

APX Drill Holders

W	38	05	H	-	200F
1	2	3	4		5

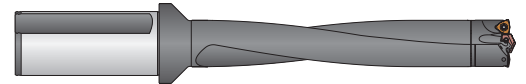

1. APX Holder	2. Series	3. Drill Length	4. Flute Style	5. Shank																						
W = Holder	<table border="0"> <tr> <td>33 = 33 series</td> <td>70 = 70 series</td> </tr> <tr> <td>38 = 38 series</td> <td>76 = 76 series</td> </tr> <tr> <td>44 = 44 series</td> <td>83 = 83 series</td> </tr> <tr> <td>51 = 51 series</td> <td>89 = 89 series</td> </tr> <tr> <td>57 = 57 series</td> <td>95 = 95 series</td> </tr> <tr> <td>63 = 63 series</td> <td></td> </tr> </table>	33 = 33 series	70 = 70 series	38 = 38 series	76 = 76 series	44 = 44 series	83 = 83 series	51 = 51 series	89 = 89 series	57 = 57 series	95 = 95 series	63 = 63 series		<table border="0"> <tr> <td>03 = 3xD</td> </tr> <tr> <td>05 = 5xD</td> </tr> <tr> <td>08 = 8xD</td> </tr> <tr> <td>10 = 10xD</td> </tr> </table>	03 = 3xD	05 = 5xD	08 = 8xD	10 = 10xD	H = Helical	<table border="0"> <tr> <td>150F = 1-1/2" flanged straight shank</td> </tr> <tr> <td>200F = 2" flanged straight shank</td> </tr> <tr> <td>40FM = 40mm flanged straight shank</td> </tr> <tr> <td>50FM = 50mm flanged straight shank</td> </tr> <tr> <td>CV40 = CAT40 integral shank</td> </tr> <tr> <td>CV50 = CAT50 integral shank</td> </tr> </table>	150F = 1-1/2" flanged straight shank	200F = 2" flanged straight shank	40FM = 40mm flanged straight shank	50FM = 50mm flanged straight shank	CV40 = CAT40 integral shank	CV50 = CAT50 integral shank
33 = 33 series	70 = 70 series																									
38 = 38 series	76 = 76 series																									
44 = 44 series	83 = 83 series																									
51 = 51 series	89 = 89 series																									
57 = 57 series	95 = 95 series																									
63 = 63 series																										
03 = 3xD																										
05 = 5xD																										
08 = 8xD																										
10 = 10xD																										
150F = 1-1/2" flanged straight shank																										
200F = 2" flanged straight shank																										
40FM = 40mm flanged straight shank																										
50FM = 50mm flanged straight shank																										
CV40 = CAT40 integral shank																										
CV50 = CAT50 integral shank																										

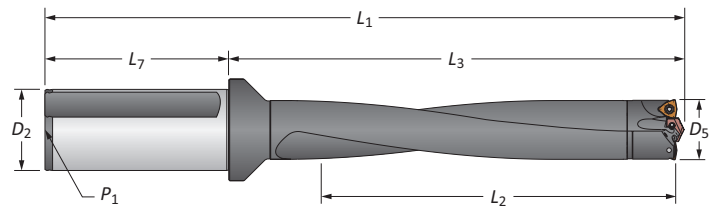
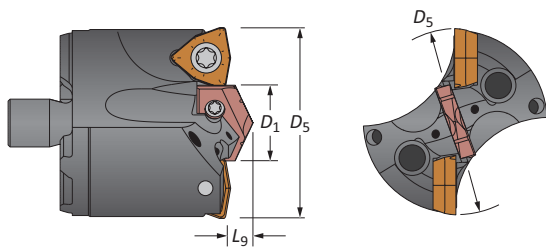

Reference Key

Symbol	Attribute
D ₁	Pilot insert diameter
D ₅	Major cutting diameter
L ₉	Pilot insert length

Reference Key

Symbol	Attribute	Symbol	Attribute
D ₂	Shank diameter	L ₃	Holder reference length
D ₅	Drill diameter range	L ₇	Shank length
L ₁	Overall length	P ₁	Rear pipe tap
L ₂	Drill depth		

APX Drill Heads

33 Series | Diameter Range: 1.2992" - 1.4960" (33.00mm - 37.99mm)

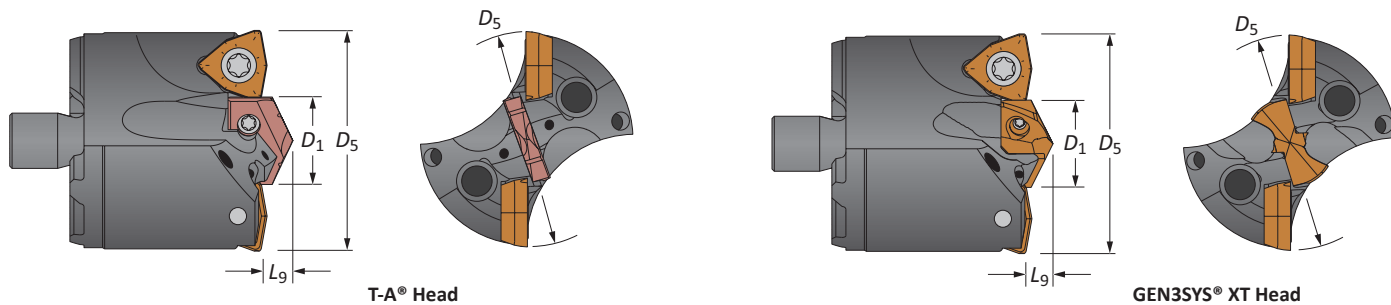

Heads

Head					T-A Head				GEN3SYS XT Head			
D ₅ fractional	D ₅ inch	D ₅ mm	D ₁	L ₉	Part No.	Pilot Series	GEN2 T-A Insert	T-A (-TC) Insert	Part No.	Pilot Series	Pilot Insert	IC Insert Size
-	1.2992	33.00	16	1/4	V3300D-33	0	4C*0H-16	1C10H-16-TC	V3316D-33	16	7C*16P-16	5/16
1-5/16	1.3125	33.34	16	1/4	V3300D-0110	0	4C*0H-16	1C10H-16-TC	V3316D-0110	16	7C*16P-16	5/16
-	1.3386	34.00	18	1/4	V3301D-34	1	4C*1H-18	1C11H-18-TC	V3318D-34	18	7C*18P-18	5/16
1-11/32	1.3438	34.13	18	1/4	V3301D-0111	1	4C*1H-18	1C11H-18-TC	V3318D-0111	18	7C*18P-18	5/16
1-3/8	1.3750	34.93	18	1/4	V3301D-0112	1	4C*1H-18	1C11H-18-TC	V3318D-0112	18	7C*18P-18	5/16
-	1.3780	35.00	18	1/4	V3301D-35	1	4C*1H-18	1C11H-18-TC	V3318D-35	18	7C*18P-18	5/16
1-13/32	1.4063	35.72	18	1/4	V3301D-0113	1	4C*1H-18	1C11H-18-TC	V3318D-0113	18	7C*18P-18	5/16
-	1.4173	36.00	20	1/4	V3301D-36	1	4C*1H-20	1C11H-20-TC	V3320D-36	20	7C*20P-20	5/16
1-7/16	1.4375	36.51	20	1/4	V3301D-0114	1	4C*1H-20	1C11H-20-TC	V3320D-0114	20	7C*20P-20	5/16
-	1.4567	37.00	20	1/4	V3301D-37	1	4C*1H-20	1C11H-20-TC	V3320D-37	20	7C*20P-20	5/16
1-15/32	1.4688	37.31	20	1/4	V3301D-0115	1	4C*1H-20	1C11H-20-TC	V3320D-0115	20	7C*20P-20	5/16

*Denotes carbide grade (1 = C1, 2 = C2)

IC Inserts

Coating	Size	Grade	Geometry	Part No.	Insert Screw	Insert Driver	Admissible Tightening Torque*
AM300®	5/16	C5 (P35)	Standard	OP-05T308-PW	IS-10-1	8IP-10	27.0 in-lbs (305 N-cm)
AM300®	5/16	C1 (K35)	Standard	OP-05T308-1PW	IS-10-1	8IP-10	27.0 in-lbs (305 N-cm)
AM300®	5/16	C2 (K25)	Standard	OP-05T308-2PW	IS-10-1	8IP-10	27.0 in-lbs (305 N-cm)
AM300®	5/16	C5 (P35)	High Rake	OP-05T308-PWHR	IS-10-1	8IP-10	27.0 in-lbs (305 N-cm)

*Tightening torques are calculated with a friction coefficient of $\mu = 0.14$ and develop 90% of ultimate yield strength

Pilot Accessories

Pilot Style	Series	Insert Screws	Insert Driver	Admissible Tightening Torque*
T-A	0	72567-IP8-1	8IP-8	15.5 in-lbs (175 N-cm)
T-A	1	7375-IP9-1	8IP-9	27.0 in-lbs (305 N-cm)
GEN3SYS	16	72556-IP8-1	8IP-8	15.5 in-lbs (175 N-cm)
GEN3SYS	18	7375-IP9-1	8IP-9	27.0 in-lbs (305 N-cm)
GEN3SYS	20	7375-IP9-1	8IP-9	27.0 in-lbs (305 N-cm)

*Tightening torques are calculated with a friction coefficient of $\mu = 0.14$ and develop 90% of ultimate yield strength

A50: 28 - 29 A50: 2 - 5 Section A20 Section A30

Non-stocked diameters are also available. Follow the examples shown below.

Inch	38 series, T-A (1 series), 1.6790"	Part No. = V3801D-1.6790
Metric	38 series, T-A (1 series), 42.15mm	Part No. = V3801D-42.15

IC inserts sold in multiples of 2 | Insert screws sold in multiples of 10

APX Drill Holders

33 Series | Diameter Range: 1.2992" - 1.4960" (33.00mm - 37.99mm)

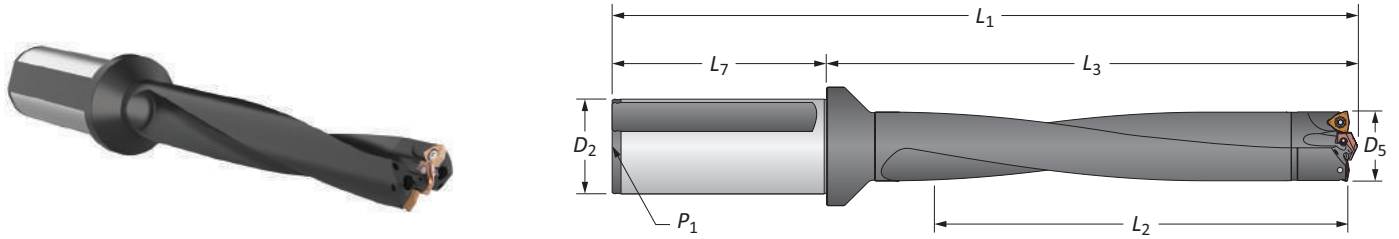

Straight Shank

	Length	D ₅	Body			Shank			Part No.
			L ₂	L ₃	L ₁	L ₇	D ₂	P ₁	
i	3xD	1.2992 - 1.4690	4-7/16	6-19/32	9-9/32	2-11/16	1-1/2	1/4	W3303H-150F
	5xD	1.2992 - 1.4690	7-27/64	9-37/64	12-9/32	2-11/16	1-1/2	1/4	W3305H-150F
	8xD	1.2992 - 1.4690	11-59/64	14-5/64	16-3/4	2-11/16	1-1/2	1/4	W3308H-150F
	10xD	1.2992 - 1.4690	14-29/32	17-1/16	19-3/4	2-11/16	1-1/2	1/4	W3310H-150F
m	3xD	33.00 - 37.99	112.6	167.4	237.4	70.0	40.0	1/4*	W3303H-40FM
	5xD	33.00 - 37.99	188.6	243.4	313.4	70.0	40.0	1/4*	W3305H-40FM
	8xD	33.00 - 37.99	302.6	357.4	427.4	70.0	40.0	1/4*	W3308H-40FM
	10xD	33.00 - 37.99	378.6	433.4	503.4	70.0	40.0	1/4*	W3310H-40FM

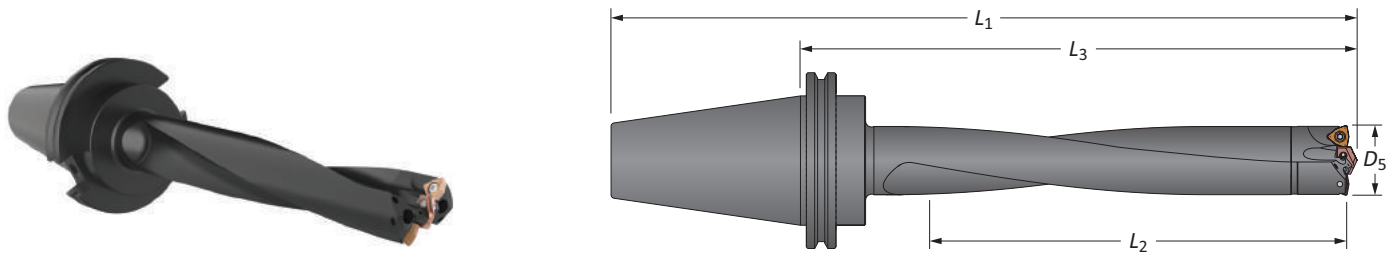

*Thread to BSP and ISO 7-1



CAT Integral Shank

	Length	D ₅		Body			Shank	Part No.
		inch	mm	L ₂	L ₃	L ₁		
i	3xD	1.2992 - 1.4690	33.00 - 37.99	4-7/16	7-3/8	10-3/16	CV40	W3303H-CV40
	5xD	1.2992 - 1.4690	33.00 - 37.99	7-27/64	10-23/64	13-11/64	CV40	W3305H-CV40
	8xD	1.2992 - 1.4690	33.00 - 37.99	11-59/64	14-55/64	17-21/32	CV40	W3308H-CV40
	10xD	1.2992 - 1.4690	33.00 - 37.99	14-29/32	17-27/32	20-21/32	CV40	W3310H-CV40
	3xD	1.2992 - 1.4690	33.00 - 37.99	4-7/16	7-3/8	11-1/2	CV50	W3303H-CV50
	5xD	1.2992 - 1.4690	33.00 - 37.99	7-27/64	10-23/64	14-31/64	CV50	W3305H-CV50
	8xD	1.2992 - 1.4690	33.00 - 37.99	11-59/64	14-55/64	18-31/32	CV50	W3308H-CV50
	10xD	1.2992 - 1.4690	33.00 - 37.99	14-29/32	17-27/32	21-31/32	CV50	W3310H-CV50

Connection Accessories

		Admissible Tightening Torque*
75020-IP20-1	8IP-20	60 in-lb (678 N-cm)

*Tightening torques are calculated with a friction coefficient of $\mu = 0.14$ and develop 90% of ultimate yield strength

⚠ WARNING Refer to Speed and Feed charts for recommended adjustments to speeds and feeds. Refer to page A50: 30 for deep hole drilling guidelines in this section of the catalog. Visit www.alliedmachine.com/DeepHoleGuidelines for the most up-to-date information and procedures. Factory technical assistance is available for your specific applications through our Application Engineering Team.

i = Imperial (in)
m = Metric (mm)



Mounting screws sold in multiples of 4

APX Drill Heads

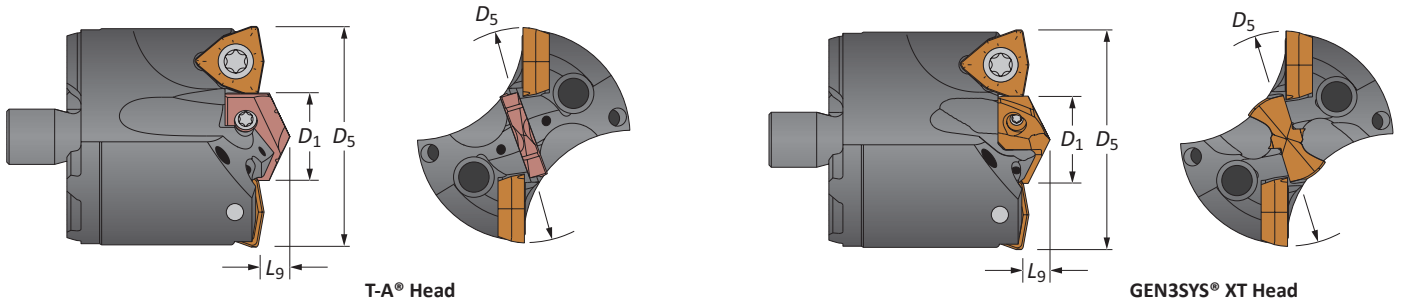
38 Series | Diameter Range: 1.4691" - 1.7322" (38.00mm - 43.99mm)





Heads

Head					T-A Head				GEN3SYS XT Head			
D ₅ fractional	D ₅ inch	D ₅ mm	D ₁	L ₉	Part No.	Pilot Series	 GEN2 T-A Insert	 T-A (-TC) Insert	Part No.	Pilot Series	 Pilot Insert	IC Insert Size
-	1.4691	38.00	5/8	19/64	V3800D-38	0	4C*0H-0020	1C10H-0020-TC	V3815D-38	15	7C*15P-0020	3/8
1-1/2	1.5000	38.10	5/8	19/64	V3800D-0116	0	4C*0H-0020	1C10H-0020-TC	V3815D-0116	15	7C*15P-0020	3/8
1-17/32	1.5313	38.90	5/8	19/64	V3800D-0117	0	4C*0H-0020	1C10H-0020-TC	V3815D-0117	15	7C*15P-0020	3/8
-	1.5354	39.00	5/8	19/64	V3800D-39	0	4C*0H-0020	1C10H-0020-TC	V3815D-39	15	7C*15P-0020	3/8
1-9/16	1.5625	39.69	5/8	19/64	V3800D-0118	0	4C*0H-0020	1C10H-0020-TC	V3815D-0118	15	7C*15P-0020	3/8
-	1.5748	40.00	11/16	19/64	V3800D-40	0	4C*0H-0022	1C10H-0022-TC	V3817D-40	17	7C*17P-0022	3/8
1-19/32	1.5938	40.48	11/16	19/64	V3800D-0119	0	4C*0H-0022	1C10H-0022-TC	V3817D-0119	17	7C*17P-0022	3/8
-	1.6142	41.00	11/16	19/64	V3800D-41	0	4C*0H-0022	1C10H-0022-TC	V3817D-41	17	7C*17P-0022	3/8
1-5/8	1.6250	41.28	11/16	19/64	V3800D-0120	0	4C*0H-0022	1C10H-0022-TC	V3817D-0120	17	7C*17P-0022	3/8
-	1.6535	42.00	3/4	19/64	V3801D-42	1	4C*1H-0024	1C11H-0024-TC	V3818D-42	18	7C*18P-0024	3/8
1-21/32	1.6563	42.07	3/4	19/64	V3801D-0121	1	4C*1H-0024	1C11H-0024-TC	V3818D-0121	18	7C*18P-0024	3/8
1-11/16	1.6875	42.86	3/4	19/64	V3801D-0122	1	4C*1H-0024	1C11H-0024-TC	V3818D-0122	18	7C*18P-0024	3/8
-	1.6929	43.00	13/16	19/64	V3801D-43	1	4C*1H-0026	1C11H-0026-TC	V3820D-43	20	7C*20P-0026	3/8
1-23/32	1.7188	43.66	13/16	19/64	V3801D-0123	1	4C*1H-0026	1C11H-0026-TC	V3820D-0123	20	7C*20P-0026	3/8



*Denotes carbide grade (1 = C1, 2 = C2)

IC Inserts

Coating	Size	Grade	Geometry	 Part No.	 Insert Screw	 Insert Driver	Admissible Tightening Torque*
AM300®	3/8	C5 (P35)	Standard	OP-060408-PW	73595-IP15-1	8IP-15	41.0 in-lbs (465 N-cm)
AM300®	3/8	C1 (K35)	Standard	OP-060408-1PW	73595-IP15-1	8IP-15	41.0 in-lbs (465 N-cm)
AM300®	3/8	C2 (K25)	Standard	OP-060408-2PW	73595-IP15-1	8IP-15	41.0 in-lbs (465 N-cm)
AM300®	3/8	C5 (P35)	High Rake	OP-060408-PWHR	73595-IP15-1	8IP-15	41.0 in-lbs (465 N-cm)

*Tightening torques are calculated with a friction coefficient of $\mu = 0.14$ and develop 90% of ultimate yield strength

Pilot Accessories

Pilot Style	Series	 Insert Screws	 Insert Driver	Admissible Tightening Torque*
T-A	0	72567-IP8-1	8IP-8	15.5 in-lbs (175 N-cm)
T-A	1	7375-IP9-1	8IP-9	27.0 in-lbs (305 N-cm)
GEN3SYS	15	7247-IP7-1	8IP-7	7.4 in-lbs (84 N-cm)
GEN3SYS	17	72567-IP8-1	8IP-8	15.5 in-lbs (175 N-cm)
GEN3SYS	18	7375-IP9-1	8IP-9	27.0 in-lbs (305 N-cm)
GEN3SYS	20	7375-IP9-1	8IP-9	27.0 in-lbs (305 N-cm)

*Tightening torques are calculated with a friction coefficient of $\mu = 0.14$ and develop 90% of ultimate yield strength

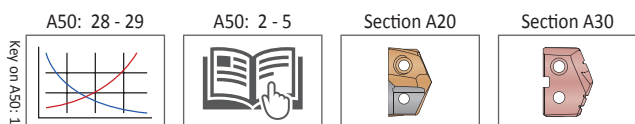

Non-stocked diameters are also available. Follow the examples shown below.

Inch	38 series, T-A (1 series), 1.6790"	Part No. = V3801D-1.6790
Metric	38 series, T-A (1 series), 42.15mm	Part No. = V3801D-42.15

IC inserts sold in multiples of 2 | Insert screws sold in multiples of 10

APX Drill Holders

38 Series | Diameter Range: 1.4691" - 1.7322" (38.00mm - 43.99mm)

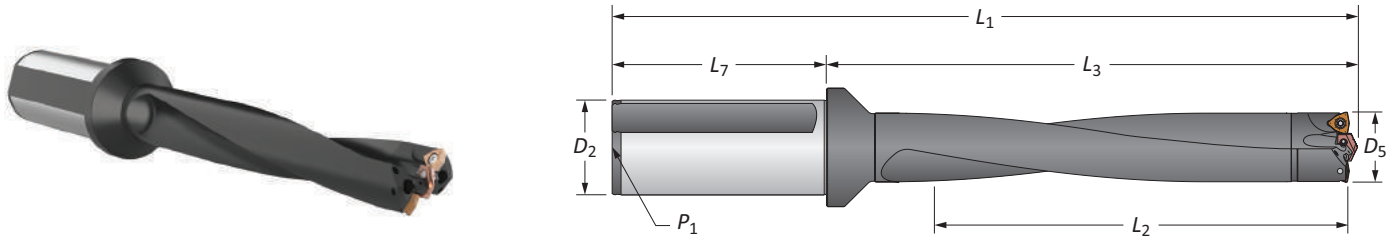

Straight Shank

	Length	D ₅	Body			Shank			Part No.
			L ₂	L ₃	L ₁	L ₇	D ₂	P ₁	
i	3xD	1.4691 - 1.7322	5-1/8	7-47/64	10-25/64	2-11/16	1-1/2	1/4	W3803H-150F
	5xD	1.4691 - 1.7322	8-5/8	11-13/64	13-55/64	2-11/16	1-1/2	1/4	W3805H-150F
	8xD	1.4691 - 1.7322	13-7/8	16-25/64	19-3/64	2-11/16	1-1/2	1/4	W3808H-150F
	10xD	1.4691 - 1.7322	17-1/4	19-27/32	22-33/64	2-11/16	1-1/2	1/4	W3810H-150F
	3xD	1.4691 - 1.7322	5-1/8	7-47/64	12-15/64	4-1/2	2	1/4	W3803H-200F
	5xD	1.4691 - 1.7322	8-5/8	11-13/64	15-45/64	4-1/2	2	1/4	W3805H-200F
	8xD	1.4691 - 1.7322	13-7/8	16-25/64	20-57/64	4-1/2	2	1/4	W3808H-200F
	10xD	1.4691 - 1.7322	17-1/4	19-27/32	24-59/64	4-1/2	2	1/4	W3810H-200F
m	3xD	38.00 - 43.99	130.5	196.5	265.7	70.0	40.0	1/4*	W3803H-40FM
	5xD	38.00 - 43.99	220.0	284.5	353.7	70.0	40.0	1/4*	W3805H-40FM
	8xD	38.00 - 43.99	352.0	416.5	485.7	70.0	40.0	1/4*	W3808H-40FM
	10xD	38.00 - 43.99	439.9	503.9	573.7	70.0	40.0	1/4*	W3810H-40FM
	3xD	38.00 - 43.99	130.5	196.5	276.5	80.0	50.0	1/4*	W3803H-50FM
	5xD	38.00 - 43.99	220.0	284.5	364.5	80.0	50.0	1/4*	W3805H-50FM
	8xD	38.00 - 43.99	352.0	416.5	496.3	80.0	50.0	1/4*	W3808H-50FM
	10xD	38.00 - 43.99	439.9	503.9	583.9	80.0	50.0	1/4*	W3810H-50FM

*Thread to BSP and ISO 7-1

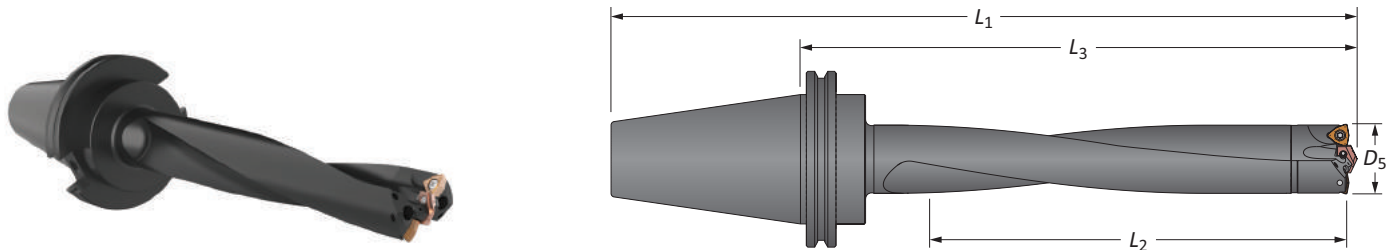

CAT Integral Shank

	Length	D ₅		Body			Shank	Part No.
		inch	mm	L ₂	L ₃	L ₁		
i	3xD	1.4691 - 1.7322	38.00 - 43.99	5-1/8	8-5/16	11	CV40	W3803H-CV40
	5xD	1.4691 - 1.7322	38.00 - 43.99	8-5/8	11-49/64	14-29/64	CV40	W3805H-CV40
	8xD	1.4691 - 1.7322	38.00 - 43.99	13-7/8	16-31/32	19-21/32	CV40	W3808H-CV40
	10xD	1.4691 - 1.7322	38.00 - 43.99	17-1/4	20-7/16	23-1/8	CV40	W3810H-CV40
	3xD	1.4691 - 1.7322	38.00 - 43.99	5-1/8	8-5/16	12-5/16	CV50	W3803H-CV50
	5xD	1.4691 - 1.7322	38.00 - 43.99	8-5/8	11-49/64	15-49/64	CV50	W3805H-CV50
	8xD	1.4691 - 1.7322	38.00 - 43.99	13-7/8	16-31/32	20-31/32	CV50	W3808H-CV50
	10xD	1.4691 - 1.7322	38.00 - 43.99	17-1/4	20-7/16	24-7/16	CV50	W3810H-CV50

Connection Accessories

		Admissible Tightening Torque*
Mounting Screw 75020-IP20-1	Mounting Screw Driver 8IP-20	
		60 in-lb (678 N-cm)

*Tightening torques are calculated with a friction coefficient of $\mu = 0.14$ and develop 90% of ultimate yield strength

⚠ WARNING Refer to Speed and Feed charts for recommended adjustments to speeds and feeds. Refer to page A50: 30 for deep hole drilling guidelines in this section of the catalog. Visit www.alliedmachine.com/DeepHoleGuidelines for the most up-to-date information and procedures. Factory technical assistance is available for your specific applications through our Application Engineering Team.

i = Imperial (in)
m = Metric (mm)

Mounting screws sold in multiples of 4

APX Drill Heads

44 Series | Diameter Range: 1.7323" - 2.0078" (44.00mm - 50.99mm)

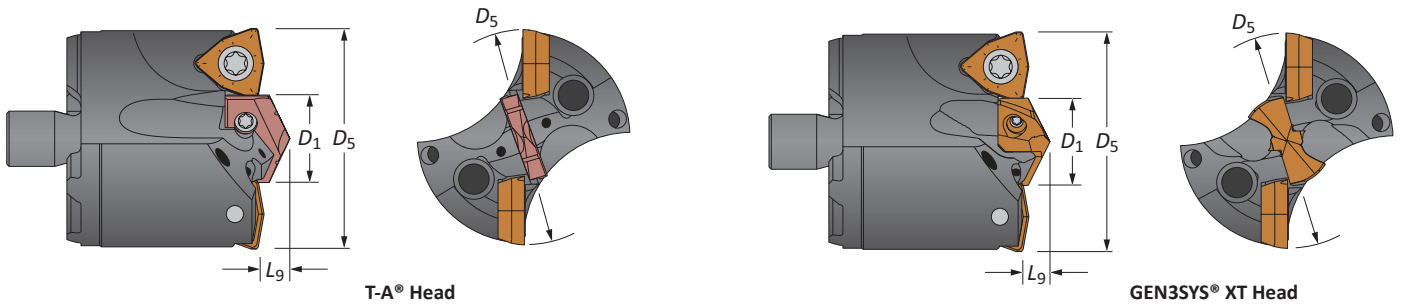

Heads

Head					T-A Head				GEN3SYS XT Head			
D ₅ fractional	D ₅ inch	D ₅ mm	D ₁	L ₉	Part No.	Pilot Series	GEN2 T-A Insert	T-A (-TC) Insert	Part No.	Pilot Series	Pilot Insert	IC Insert Size
-	1.7323	44.00	7/8	21/64	V4401D-44	1	4C*1H-0028	1C11H-0028-TC	V4422D-44	22	7C*22P-0028	3/8
1-3/4	1.7500	44.45	7/8	21/64	V4401D-0124	1	4C*1H-0028	1C11H-0028-TC	V4422D-0124	22	7C*22P-0028	3/8
-	1.7717	45.00	7/8	21/64	V4401D-45	1	4C*1H-0028	1C11H-0028-TC	V4422D-45	22	7C*22P-0028	3/8
1-25/32	1.7813	45.25	7/8	21/64	V4401D-0125	1	4C*1H-0028	1C11H-0028-TC	V4422D-0125	22	7C*22P-0028	3/8
-	1.8110	46.00	15/16	21/64	V4401D-46	1	4C*1H-0030	1C11H-0030-TC	V4422D-46	22	7C*22P-0030	3/8
1-13/16	1.8125	46.04	15/16	21/64	V4401D-0126	1	4C*1H-0030	1C11H-0030-TC	V4422D-0126	22	7C*22P-0030	3/8
1-27/32	1.8438	46.83	15/16	21/64	V4401D-0127	1	4C*1H-0030	1C11H-0030-TC	V4422D-0127	22	7C*22P-0030	3/8
-	1.8504	47.00	15/16	21/64	V4401D-47	1	4C*1H-0030	1C11H-0030-TC	V4422D-47	22	7C*22P-0030	3/8
1-7/8	1.8750	47.63	15/16	21/64	V4401D-0128	1	4C*1H-0030	1C11H-0030-TC	V4422D-0128	22	7C*22P-0030	3/8
-	1.8898	48.00	45/64	21/64	V4401D-48	1	4C*1H-.703	1C11H-.703-TC	V4417D-48	17	7C*17P-.703	1/2
1-29/32	1.9063	48.42	45/64	21/64	V4401D-0129	1	4C*1H-.703	1C11H-.703-TC	V4417D-0129	17	7C*17P-.703	1/2
-	1.9291	49.00	45/64	21/64	V4401D-49	1	4C*1H-.703	1C11H-.703-TC	V4417D-49	17	7C*17P-.703	1/2
1-15/16	1.9375	49.21	45/64	21/64	V4401D-0130	1	4C*1H-.703	1C11H-.703-TC	V4417D-0130	17	7C*17P-.703	1/2
-	1.9685	50.00	47/64	21/64	V4401D-50	1	4C*1H-.734	1C11H-.734-TC	V4418D-50	18	7C*18P-.734	1/2
1-31/32	1.9688	50.01	47/64	21/64	V4401D-0131	1	4C*1H-.734	1C11H-.734-TC	V4418D-0131	18	7C*18P-.734	1/2
2	2.0000	50.80	47/64	21/64	V4401D-0200	1	4C*1H-.734	1C11H-.734-TC	V4418D-0200	18	7C*18P-.734	1/2

*Denotes carbide grade (1 = C1, 2 = C2)

IC Inserts

Coating	Size	Grade	Geometry	Part No.	Insert Screw	Insert Driver	Admissible Tightening Torque*
AM300®	3/8	C5 (P35)	Standard	OP-060408-PW	73595-IP15-1	8IP-15	41.0 in-lbs (465 N-cm)
AM300®	3/8	C1 (K35)	Standard	OP-060408-1PW	73595-IP15-1	8IP-15	41.0 in-lbs (465 N-cm)
AM300®	3/8	C2 (K25)	Standard	OP-060408-2PW	73595-IP15-1	8IP-15	41.0 in-lbs (465 N-cm)
AM300®	3/8	C5 (P35)	High Rake	OP-060408-PWHR	73595-IP15-1	8IP-15	41.0 in-lbs (465 N-cm)
AM300®	1/2	C5 (P35)	Standard	OP-080508-PW	74012-IP15-1	8IP-15	61.0 in-lbs (690 N-cm)
AM300®	1/2	C1 (K35)	Standard	OP-080508-1PW	74012-IP15-1	8IP-15	61.0 in-lbs (690 N-cm)
AM300®	1/2	C2 (K25)	Standard	OP-080508-2PW	74012-IP15-1	8IP-15	61.0 in-lbs (690 N-cm)
AM300®	1/2	C5 (P35)	High Rake	OP-080508-PWHR	74012-IP15-1	8IP-15	61.0 in-lbs (690 N-cm)

*Tightening torques are calculated with a friction coefficient of $\mu = 0.14$ and develop 90% of ultimate yield strength

Pilot Accessories

Pilot Style	Series	Insert Screws	Insert Driver	Admissible Tightening Torque*
T-A	1	7375-IP9-1	8IP-9	27.0 in-lbs (305 N-cm)
GEN3SYS	17	72567-IP8-1	8IP-8	15.5 in-lbs (175 N-cm)
GEN3SYS	18	7375-IP9-1	8IP-9	27.0 in-lbs (305 N-cm)
GEN3SYS	22	739-IP9-1	8IP-9	27.0 in-lbs (305 N-cm)

*Tightening torques are calculated with a friction coefficient of $\mu = 0.14$ and develop 90% of ultimate yield strength

A50: 28 - 29 | A50: 2 - 5 | Section A20 | Section A30

Non-stocked diameters are also available. Follow the examples shown below.

Inch	38 series, T-A (1 series), 1.6790"	Part No. = V3801D-1.6790
Metric	38 series, T-A (1 series), 42.15mm	Part No. = V3801D-42.15

IC inserts sold in multiples of 2 | Insert screws sold in multiples of 10

APX Drill Holders

44 Series | Diameter Range: 1.7323" - 2.0078" (44.00mm - 50.99mm)

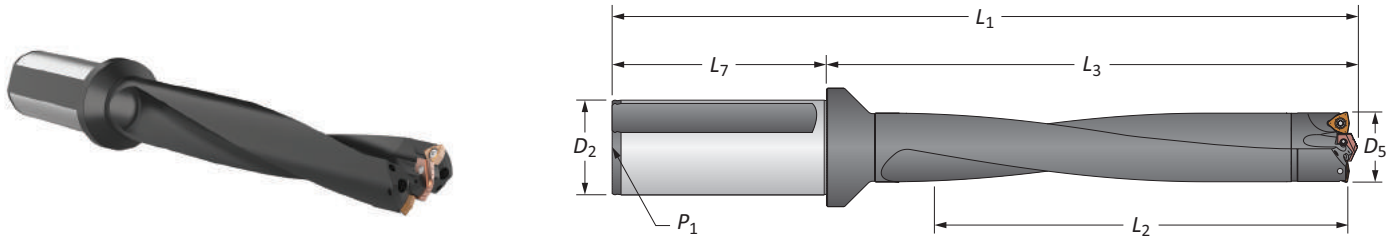

Straight Shank

	Length	D ₅	Body			Shank			Part No.
			L ₂	L ₃	L ₁	L ₇	D ₂	P ₁	
i	3xD	1.7323 - 2.0078	6	8-17/32	11-15/64	2-11/16	1-1/2	1/4	W4403H-150F
	5xD	1.7323 - 2.0078	10	12-35/64	15-1/4	2-11/16	1-1/2	1/4	W4405H-150F
	8xD	1.7323 - 2.0078	16	18-37/64	21-17/64	2-11/16	1-1/2	1/4	W4408H-150F
	10xD	1.7323 - 2.0078	20-1/8	22-19/32	25-9/32	2-11/16	1-1/2	1/4	W4410H-150F
	3xD	1.7323 - 2.0078	6	8-33/64	13-1/32	4-1/2	2	1/4	W4403H-200F
	5xD	1.7323 - 2.0078	10	12-35/64	17-3/64	4-1/2	2	1/4	W4405H-200F
	8xD	1.7323 - 2.0078	16	18-37/64	23-5/64	4-1/2	2	1/4	W4408H-200F
	10xD	1.7323 - 2.0078	20-1/8	22-19/32	27-3/32	4-1/2	2	1/4	W4410H-200F
m	3xD	44.00 - 50.99	151.5	216.8	286.9	70.0	40.0	1/4*	W4403H-40FM
	5xD	44.00 - 50.99	255.0	318.8	388.9	70.0	40.0	1/4*	W4405H-40FM
	8xD	44.00 - 50.99	407.9	471.8	541.8	70.0	40.0	1/4*	W4408H-40FM
	10xD	44.00 - 50.99	510.0	573.8	643.8	70.0	40.0	1/4*	W4410H-40FM
	3xD	44.00 - 50.99	151.5	216.8	296.9	80.0	50.0	1/4*	W4403H-50FM
	5xD	44.00 - 50.99	255.0	318.8	398.8	80.0	50.0	1/4*	W4405H-50FM
	8xD	44.00 - 50.99	407.9	471.8	551.7	80.0	50.0	1/4*	W4408H-50FM
	10xD	44.00 - 50.99	510.0	573.8	653.8	80.0	50.0	1/4*	W4410H-50FM

*Thread to BSP and ISO 7-1

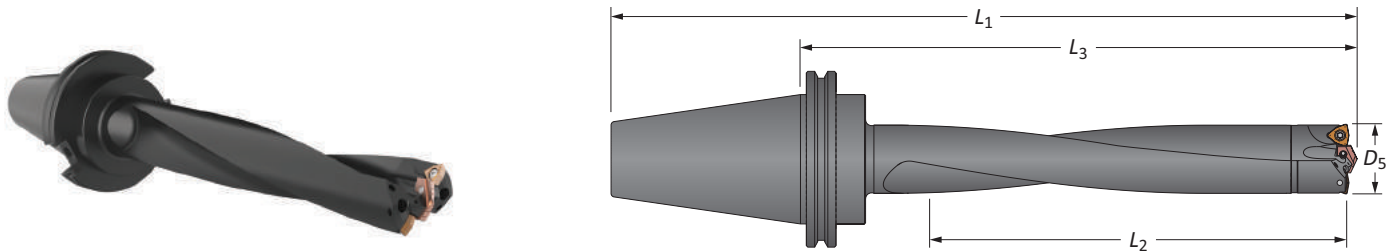

CAT Integral Shank

	Length	D ₅		Body			Shank	Part No.
		inch	mm	L ₂	L ₃	L ₁		
i	3xD	1.7323 - 2.0078	44.00 - 50.99	6	9-1/4	11-15/16	CV40	W4403H-CV40
	5xD	1.7323 - 2.0078	44.00 - 50.99	10	13-17/64	15-61/64	CV40	W4405H-CV40
	8xD	1.7323 - 2.0078	44.00 - 50.99	16	19-19/64	21-63/64	CV40	W4408H-CV40
	10xD	1.7323 - 2.0078	44.00 - 50.99	20-1/8	23-5/16	26	CV40	W4410H-CV40
	3xD	1.7323 - 2.0078	44.00 - 50.99	6	9-1/4	13-1/4	CV50	W4403H-CV50
	5xD	1.7323 - 2.0078	44.00 - 50.99	10	13-17/64	17-17/64	CV50	W4405H-CV50
	8xD	1.7323 - 2.0078	44.00 - 50.99	16	19-19/64	23-19/64	CV50	W4408H-CV50
	10xD	1.7323 - 2.0078	44.00 - 50.99	20	23-5/16	27-5/16	CV50	W4410H-CV50

Connection Accessories

		Admissible Tightening Torque*
Mounting Screw 75020-IP20-1	Mounting Screw Driver 8IP-20	
		60 in-lb (678 N-cm)

*Tightening torques are calculated with a friction coefficient of $\mu = 0.14$ and develop 90% of ultimate yield strength

⚠ WARNING Refer to Speed and Feed charts for recommended adjustments to speeds and feeds. Refer to page A50: 30 for deep hole drilling guidelines in this section of the catalog. Visit www.alliedmachine.com/DeepHoleGuidelines for the most up-to-date information and procedures. Factory technical assistance is available for your specific applications through our Application Engineering Team.

i = Imperial (in)
m = Metric (mm)

Mounting screws sold in multiples of 4

APX Drill Heads

51 Series | Diameter Range: 2.0079" - 2.2440" (51.00mm - 56.99mm)

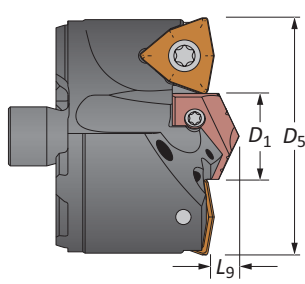

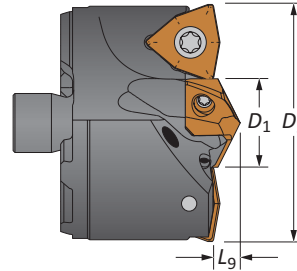
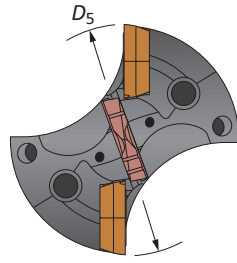

T-A® Head

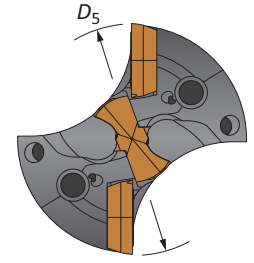

GEN3SYS® XT Head





Heads

Head					T-A Head				GEN3SYS XT Head			IC Insert Size
D_5 fractional	D_5 inch	D_5 mm	D_1	L_9	Part No.	Pilot Series			Part No.	Pilot Series		
-	2.0079	51.00	25/32	11/32	V5101D-51	1	4C*1H-0025	1C11H-0025-TC	V5118D-51	18	7C*18P-0025	1/2
2-1/32	2.0313	51.59	25/32	11/32	V5101D-0201	1	4C*1H-0025	1C11H-0025-TC	V5118D-0201	18	7C*18P-0025	1/2
-	2.0472	52.00	25/32	11/32	V5101D-52	1	4C*1H-0025	1C11H-0025-TC	V5118D-52	18	7C*18P-0025	1/2
2-1/16	2.0625	52.39	25/32	11/32	V5101D-0202	1	4C*1H-0025	1C11H-0025-TC	V5118D-0202	18	7C*18P-0025	1/2
-	2.0866	53.00	27/32	11/32	V5101D-53	1	4C*1H-0027	1C11H-0027-TC	V5120D-53	20	7C*20P-0027	1/2
2-3/32	2.0938	53.18	27/32	11/32	V5101D-0203	1	4C*1H-0027	1C11H-0027-TC	V5120D-0203	20	7C*20P-0027	1/2
2-1/8	2.1250	53.98	27/32	11/32	V5101D-0204	1	4C*1H-0027	1C11H-0027-TC	V5120D-0204	20	7C*20P-0027	1/2
-	2.1260	54.00	15/16	11/32	V5101D-54	1	4C*1H-0030	1C11H-0030-TC	V5122D-54	22	7C*22P-0030	1/2
2-5/32	2.1563	54.77	15/16	11/32	V5101D-0205	1	4C*1H-0030	1C11H-0030-TC	V5122D-0205	22	7C*22P-0030	1/2
-	2.1654	55.00	15/16	11/32	V5101D-55	1	4C*1H-0030	1C11H-0030-TC	V5122D-55	22	7C*22P-0030	1/2
2-3/16	2.1875	55.56	15/16	11/32	V5101D-0206	1	4C*1H-0030	1C11H-0030-TC	V5122D-0206	22	7C*22P-0030	1/2
-	2.2047	56.00	15/16	11/32	V5101D-56	1	4C*1H-0030	1C11H-0030-TC	V5122D-56	22	7C*22P-0030	1/2
2-7/32	2.2188	56.36	13/16	11/32	V5101D-0207	1	4C*1H-0026	1C11H-0026-TC	V5120D-0207	20	7C*20P-0026	9/16



*Denotes carbide grade (1 = C1, 2 = C2)

IC Inserts

Coating	Size	Grade	Geometry	 Part No.	 Insert Screw	 Insert Driver	Admissible Tightening Torque*
AM300®	1/2	C5 (P35)	Standard	OP-080508-PW	74012-IP15-1	8IP-15	61.0 in-lbs (690 N-cm)
AM300®	1/2	C1 (K35)	Standard	OP-080508-1PW	74012-IP15-1	8IP-15	61.0 in-lbs (690 N-cm)
AM300®	1/2	C2 (K25)	Standard	OP-080508-2PW	74012-IP15-1	8IP-15	61.0 in-lbs (690 N-cm)
AM300®	1/2	C5 (P35)	High Rake	OP-080508-PWHR	74012-IP15-1	8IP-15	61.0 in-lbs (690 N-cm)
AM300®	9/16	C5 (P35)	Standard	OP-090608-PW	75014-IP20-1	8IP-20	121.0 in-lbs (1370 N-cm)
AM300®	9/16	C1 (K35)	Standard	OP-090608-1PW	75014-IP20-1	8IP-20	121.0 in-lbs (1370 N-cm)
AM300®	9/16	C2 (K25)	Standard	OP-090608-2PW	75014-IP20-1	8IP-20	121.0 in-lbs (1370 N-cm)
AM300®	9/16	C5 (P35)	High Rake	OP-090608-PWHR	75014-IP20-1	8IP-20	121.0 in-lbs (1370 N-cm)

*Tightening torques are calculated with a friction coefficient of $\mu = 0.14$ and develop 90% of ultimate yield strength

Pilot Accessories

Pilot Style	Series	 Insert Screws	 Insert Driver	Admissible Tightening Torque*
T-A	1	7375-IP9-1	8IP-9	27.0 in-lbs (305 N-cm)
GEN3SYS	18	7375-IP9-1	8IP-9	27.0 in-lbs (305 N-cm)
GEN3SYS	20	7375-IP9-1	8IP-9	27.0 in-lbs (305 N-cm)
GEN3SYS	22	739-IP9-1	8IP-9	27.0 in-lbs (305 N-cm)

*Tightening torques are calculated with a friction coefficient of $\mu = 0.14$ and develop 90% of ultimate yield strength

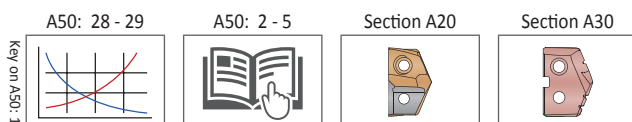

Non-stocked diameters are also available. Follow the examples shown below.

Inch	38 series, T-A (1 series), 1.6790"	Part No. = V3801D-1.6790
Metric	38 series, T-A (1 series), 42.15mm	Part No. = V3801D-42.15

IC inserts sold in multiples of 2 | Insert screws sold in multiples of 10



APX Drill Holders

51 Series | Diameter Range: 2.0079" - 2.2440" (51.00mm - 56.99mm)

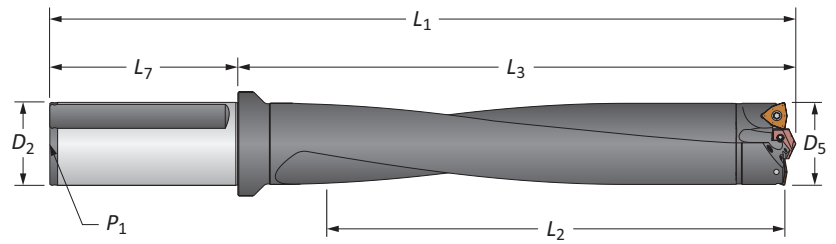

Straight Shank

	Length	D ₅	Body			Shank			Part No.
			L ₂	L ₃	L ₁	L ₇	D ₂	P ₁	
i	3xD	2.0079 - 2.2438	6-3/8	8-7/8	13-3/8	4-1/2	2	1/4	W5103H-200F
	5xD	2.0079 - 2.2438	11-1/8	13-3/8	17-7/8	4-1/2	2	1/4	W5105H-200F
	8xD	2.0079 - 2.2438	17-7/8	20-3/32	24-19/32	4-1/2	2	1/4	⚠ W5108H-200F
	10xD	2.0079 - 2.2438	22-3/8	24-19/32	29-3/32	4-1/2	2	1/4	⚠ W5110H-200F
m	3xD	51.00 - 56.99	161.8	225.5	305.5	80.0	50.0	1/4*	W5103H-50FM
	5xD	51.00 - 56.99	285.0	339.6	419.6	80.0	50.0	1/4*	W5105H-50FM
	8xD	51.00 - 56.99	455.9	510.5	590.5	80.0	50.0	1/4*	⚠ W5108H-50FM
	10xD	51.00 - 56.99	570.0	624.6	704.6	80.0	50.0	1/4*	⚠ W5110H-50FM

*Thread to BSP and ISO 7-1

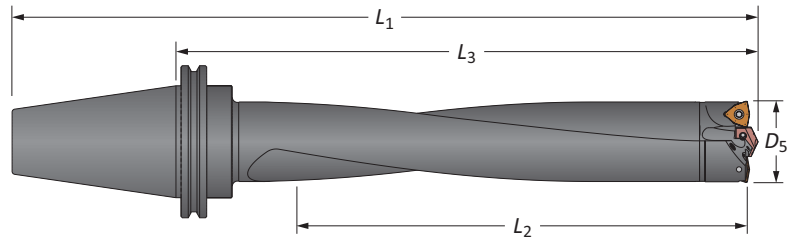

CV50 Shank

	Length	D ₅		Body			Shank	Part No.
		inch	mm	L ₂	L ₃	L ₁		
i	3xD	2.0079 - 2.2440	51.00 - 56.99	6-3/8	9-47/64	13-47/64	CV50	W5103H-CV50
	5xD	2.0079 - 2.2440	51.00 - 56.99	11-1/4	14-7/32	18-7/32	CV50	W5105H-CV50
	8xD	2.0079 - 2.2440	51.00 - 56.99	17-7/8	20-61/64	24-61/64	CV50	⚠ W5108H-CV50
	10xD	2.0079 - 2.2440	51.00 - 56.99	22-3/8	25-7/16	29-7/16	CV50	⚠ W5110H-CV50

Connection Accessories

Mounting Screw	Mounting Screw Driver	Admissible Tightening Torque*
75020-IP20-1	8IP-20	60 in-lb (678 N-cm)

*Tightening torques are calculated with a friction coefficient of $\mu = 0.14$ and develop 90% of ultimate yield strength

⚠ WARNING Refer to Speed and Feed charts for recommended adjustments to speeds and feeds. Refer to page A50: 30 for deep hole drilling guidelines in this section of the catalog. Visit www.alliedmachine.com/DeepHoleGuidelines for the most up-to-date information and procedures. Factory technical assistance is available for your specific applications through our Application Engineering Team.

i = Imperial (in)
m = Metric (mm)

Mounting screws sold in multiples of 4

APX Drill Heads

57 Series | Diameter Range: 2.2441" - 2.4802" (57.00mm - 62.99mm)

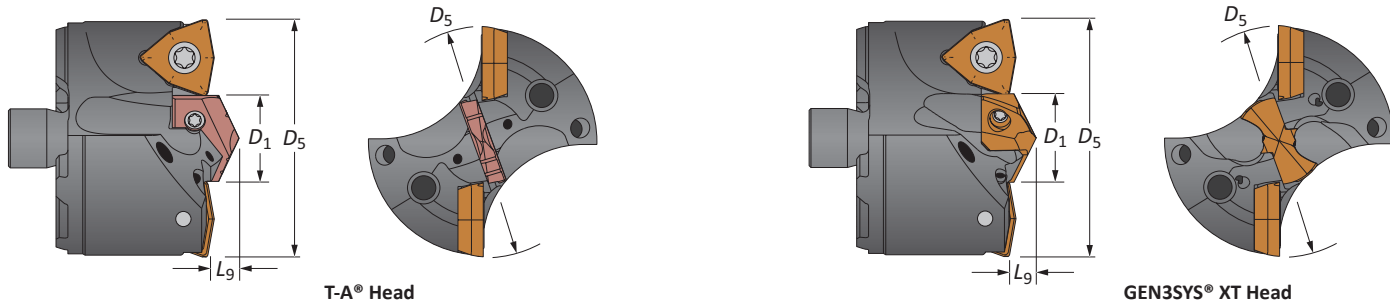

Heads

Head					T-A Head				GEN3SYS XT Head			
D ₅ fractional	D ₅ inch	D ₅ mm	D ₁	L ₉	Part No.	Pilot Series	GEN2 T-A Insert	T-A (-TC) Insert	Part No.	Pilot Series	Pilot Insert	IC Insert Size
-	2.2441	57.00	29/32	25/64	V5701D-57	1	4C*1H-0029	1C11H-0029-TC	V5722D-57	22	7C*22P-0029	9/16
2-1/4	2.2500	57.15	29/32	25/64	V5701D-0208	1	4C*1H-0029	1C11H-0029-TC	V5722D-0208	22	7C*22P-0029	9/16
2-9/32	2.2813	57.94	29/32	25/64	V5701D-0209	1	4C*1H-0029	1C11H-0029-TC	V5722D-0209	22	7C*22P-0029	9/16
-	2.2835	58.00	29/32	25/64	V5701D-58	1	4C*1H-0029	1C11H-0029-TC	V5722D-58	22	7C*22P-0029	9/16
2-5/16	2.3125	58.74	29/32	25/64	V5701D-0210	1	4C*1H-0029	1C11H-0029-TC	V5722D-0210	22	7C*22P-0029	9/16
-	2.3228	59.00	15/16	25/64	V5701D-59	1	4C*1H-0030	1C11H-0030-TC	V5722D-59	22	7C*22P-0030	9/16
2-11/32	2.3438	59.53	15/16	25/64	V5701D-0211	1	4C*1H-0030	1C11H-0030-TC	V5722D-0211	22	7C*22P-0030	9/16
-	2.3622	60.00	15/16	25/64	V5701D-60	1	4C*1H-0030	1C11H-0030-TC	V5722D-60	22	7C*22P-0030	9/16
2-3/8	2.3750	60.33	15/16	25/64	V5701D-0212	1	4C*1H-0030	1C11H-0030-TC	V5722D-0212	22	7C*22P-0030	9/16
-	2.4016	61.00	1	25/64	V5702D-61	2	4C*2H-0100	1C12H-0100-TC	V5724D-61	24	7C*24P-0100	9/16
2-13/32	2.4063	61.12	1	25/64	V5702D-0213	2	4C*2H-0100	1C12H-0100-TC	V5724D-0213	24	7C*24P-0100	9/16
2-7/16	2.4375	61.91	1	25/64	V5702D-0214	2	4C*2H-0100	1C12H-0100-TC	V5724D-0214	24	7C*24P-0100	9/16
-	2.4409	62.00	1-1/16	25/64	V5702D-62	2	4C*2H-0102	1C12H-0102-TC	V5726D-62	26	7C*26P-0102	9/16
2-15/32	2.4688	62.71	1-1/16	25/64	V5702D-0215	2	4C*2H-0102	1C12H-0102-TC	V5726D-0215	26	7C*26P-0102	9/16

*Denotes carbide grade (1 = C1, 2 = C2)

IC Inserts

Coating	Size	Grade	Geometry	Part No.	Insert Screw	Insert Driver	Admissible Tightening Torque*
AM300®	9/16	C5 (P35)	Standard	OP-090608-PW	75014-IP20-1	8IP-20	121.0 in-lbs (1370 N-cm)
AM300®	9/16	C1 (K35)	Standard	OP-090608-1PW	75014-IP20-1	8IP-20	121.0 in-lbs (1370 N-cm)
AM300®	9/16	C2 (K25)	Standard	OP-090608-2PW	75014-IP20-1	8IP-20	121.0 in-lbs (1370 N-cm)
AM300®	9/16	C5 (P35)	High Rake	OP-090608-PWHR	75014-IP20-1	8IP-20	121.0 in-lbs (1370 N-cm)

*Tightening torques are calculated with a friction coefficient of $\mu = 0.14$ and develop 90% of ultimate yield strength

Pilot Accessories

Pilot Style	Series	Insert Screws	Insert Driver	Admissible Tightening Torque*
T-A	1	7375-IP9-1	8IP-9	27.0 in-lbs (305 N-cm)
T-A	2	7495-IP15-1	8IP-15	61.0 in-lbs (690 N-cm)
GEN3SYS	22	739-IP9-1	8IP-9	27.0 in-lbs (305 N-cm)
GEN3SYS	24	739-IP9-1	8IP-9	27.0 in-lbs (305 N-cm)
GEN3SYS	26	7495-IP15-1	8IP-15	61.0 in-lbs (690 N-cm)

*Tightening torques are calculated with a friction coefficient of $\mu = 0.14$ and develop 90% of ultimate yield strength

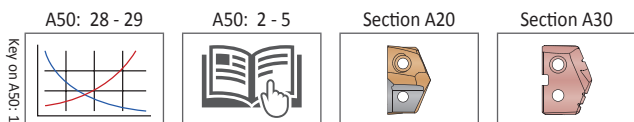

Non-stocked diameters are also available. Follow the examples shown below.

Inch	38 series, T-A (1 series), 1.6790"	Part No. = V3801D-1.6790
Metric	38 series, T-A (1 series), 42.15mm	Part No. = V3801D-42.15

IC inserts sold in multiples of 2 | Insert screws sold in multiples of 10

A DRILLING
B BORING
C REAMING
D BURNISHING
E THREADING
X SPECIALS

APX Drill Holders

57 Series | Diameter Range: 2.2441" - 2.4802" (57.00mm - 62.99mm)

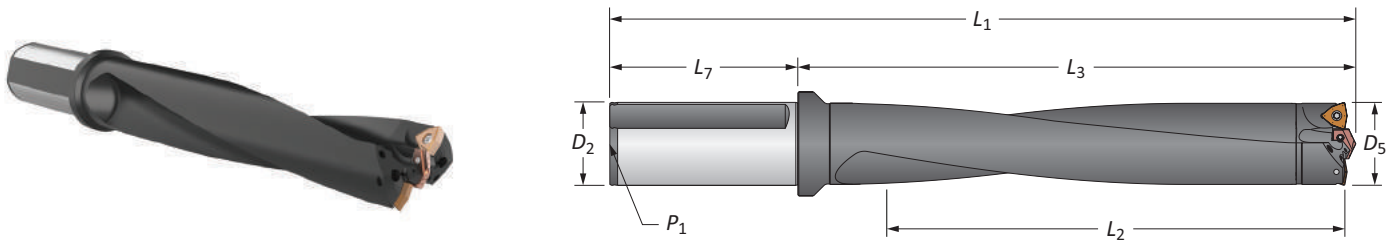

Straight Shank

	Length	D ₅	Body			Shank			Part No.
			L ₂	L ₃	L ₁	L ₇	D ₂	P ₁	
i	3xD	2.2441 - 2.4802	7-1/8	9-35/64	14-1/16	4-1/2	2	1/4	W5703H-200F
	5xD	2.2441 - 2.4802	12-3/8	14-33/64	19-1/64	4-1/2	2	1/4	W5705H-200F
	8xD	2.2441 - 2.4802	19-3/4	21-31/32	26-15/32	4-1/2	2	1/4	⚠ W5708H-200F
	10xD	2.2441 - 2.4802	24-3/4	26-59/64	31-27/64	4-1/2	2	1/4	⚠ W5710H-200F
m	3xD	57.00 - 62.99	179.9	242.7	322.7	80.0	50.0	1/4*	W5703H-50FM
	5xD	57.00 - 62.99	315.0	368.6	448.6	80.0	50.0	1/4*	W5705H-50FM
	8xD	57.00 - 62.99	503.9	557.8	637.8	80.0	50.0	1/4*	⚠ W5708H-50FM
	10xD	57.00 - 62.99	626.9	683.8	763.8	80.0	50.0	1/4*	⚠ W5710H-50FM

*Thread to BSP and ISO 7-1

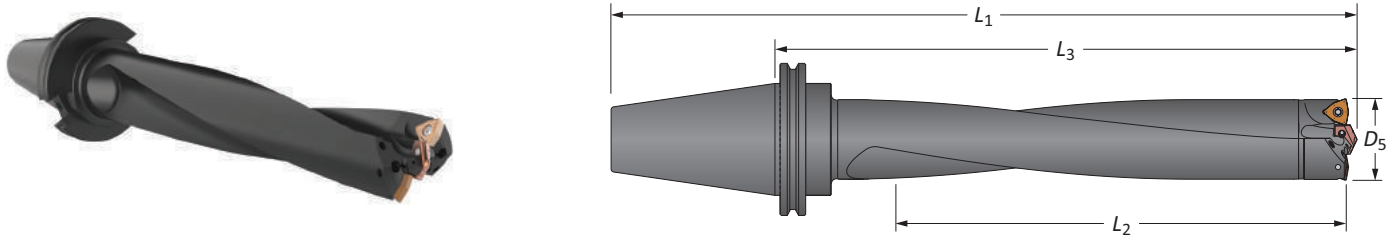

CV50 Shank

	Length	D ₅		Body			Shank	Part No.
		inch	mm	L ₂	L ₃	L ₁		
i	3xD	2.2441 - 2.4802	57.00 - 62.99	7-1/8	10-17/32	14-17/32	CV50	W5703H-CV50
	5xD	2.2441 - 2.4802	57.00 - 62.99	12-3/8	15-31/64	19-31/64	CV50	W5705H-CV50
	8xD	2.2441 - 2.4802	57.00 - 62.99	19-7/8	22-15/16	26-15/16	CV50	⚠ W5708H-CV50
	10xD	2.2441 - 2.4802	57.00 - 62.99	24-3/4	27-57/64	31-57/64	CV50	⚠ W5710H-CV50

Connection Accessories

		Admissible Tightening Torque*
Mounting Screw	Mounting Screw Driver	
75020-IP20-1	8IP-20	60 in-lb (678 N-cm)

*Tightening torques are calculated with a friction coefficient of $\mu = 0.14$ and develop 90% of ultimate yield strength

⚠ WARNING Refer to Speed and Feed charts for recommended adjustments to speeds and feeds. Refer to page A50: 30 for deep hole drilling guidelines in this section of the catalog. Visit www.alliedmachine.com/DeepHoleGuidelines for the most up-to-date information and procedures. Factory technical assistance is available for your specific applications through our Application Engineering Team.

i = Imperial (in)
m = Metric (mm)



Mounting screws sold in multiples of 4

APX Drill Heads

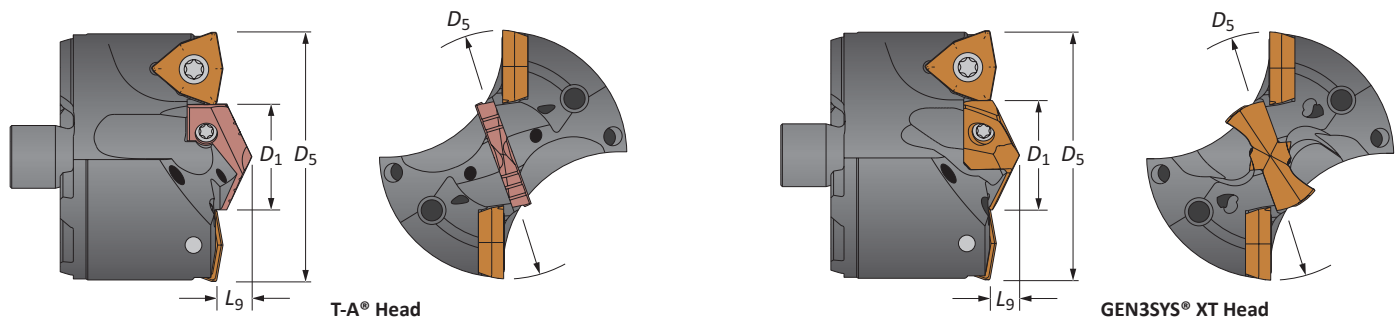
63 Series | Diameter Range: 2.4803" - 2.7558" (63.00mm - 69.99mm)





Heads

Head					T-A Head				GEN3SYS XT Head			
D_5 fractional	D_5 inch	D_5 mm	D_1	L_9	Part No.	Pilot Series			Part No.	Pilot Series		IC Insert Size
-	2.4803	63.00	1-1/8	7/16	V6302D-63	2	4C*2H-0104	1C12H-0104-TC	V6326D-63	26	7C*26P-0104	9/16
2-1/2	2.5000	63.50	1-1/8	7/16	V6302D-0216	2	4C*2H-0104	1C12H-0104-TC	V6326D-0216	26	7C*26P-0104	9/16
-	2.5197	64.00	1-1/8	7/16	V6302D-64	2	4C*2H-0104	1C12H-0104-TC	V6326D-64	26	7C*26P-0104	9/16
2-17/32	2.5313	64.29	1-1/8	7/16	V6302D-0217	2	4C*2H-0104	1C12H-0104-TC	V6326D-0217	26	7C*26P-0104	9/16
-	2.5591	65.00	1-1/8	7/16	V6302D-65	2	4C*2H-0104	1C12H-0104-TC	V6326D-65	26	7C*26P-0104	9/16
2-9/16	2.5625	65.09	1-3/16	7/16	V6302D-0218	2	4C*2H-0106	1C12H-0106-TC	V6329D-0218	29	7C*29P-0106	9/16
2-19/32	2.5938	65.88	1-3/16	7/16	V6302D-0219	2	4C*2H-0106	1C12H-0106-TC	V6329D-0219	29	7C*29P-0106	9/16
-	2.5984	66.00	1-3/16	7/16	V6302D-66	2	4C*2H-0106	1C12H-0106-TC	V6329D-66	29	7C*29P-0106	9/16
2-5/8	2.6250	66.68	1-3/16	7/16	V6302D-0220	2	4C*2H-0106	1C12H-0106-TC	V6329D-0220	29	7C*29P-0106	9/16
-	2.6378	67.00	1-1/4	7/16	V6302D-67	2	4C*2H-0108	1C12H-0108-TC	V6329D-67	29	7C*29P-0108	9/16
2-21/32	2.6563	67.47	1-1/4	7/16	V6302D-0221	2	4C*2H-0108	1C12H-0108-TC	V6329D-0221	29	7C*29P-0108	9/16
-	2.6772	68.00	1-1/4	7/16	V6302D-68	2	4C*2H-0108	1C12H-0108-TC	V6329D-68	29	7C*29P-0108	9/16
2-11/16	2.6875	68.26	1-1/4	7/16	V6302D-0222	2	4C*2H-0108	1C12H-0108-TC	V6329D-0222	29	7C*29P-0108	9/16
-	2.7165	69.00	1-5/16	7/16	V6302D-69	2	4C*2H-0110	1C12H-0110-TC	V6332D-69	32	7C*32P-0110	9/16
2-23/32	2.7188	69.06	1-5/16	7/16	V6302D-0223	2	4C*2H-0110	1C12H-0110-TC	V6332D-0223	32	7C*32P-0110	9/16
2-3/4	2.7500	69.85	1-5/16	7/16	V6302D-0224	2	4C*2H-0110	1C12H-0110-TC	V6332D-0224	32	7C*32P-0110	9/16



*Denotes carbide grade (1 = C1, 2 = C2)

IC Inserts

Coating	Size	Grade	Geometry	 Part No.	 Insert Screw	 Insert Driver	Admissible Tightening Torque*
AM300®	9/16	C5 (P35)	Standard	OP-090608-PW	75014-IP20-1	8IP-20	121.0 in-lbs (1370 N-cm)
AM300®	9/16	C1 (K35)	Standard	OP-090608-1PW	75014-IP20-1	8IP-20	121.0 in-lbs (1370 N-cm)
AM300®	9/16	C2 (K25)	Standard	OP-090608-2PW	75014-IP20-1	8IP-20	121.0 in-lbs (1370 N-cm)
AM300®	9/16	C5 (P35)	High Rake	OP-090608-PWHR	75014-IP20-1	8IP-20	121.0 in-lbs (1370 N-cm)

*Tightening torques are calculated with a friction coefficient of $\mu = 0.14$ and develop 90% of ultimate yield strength

Pilot Accessories

Pilot Style	Series	 Insert Screws	 Insert Driver	Admissible Tightening Torque*
T-A	2	7495-IP15-1	8IP-15	61.0 in-lbs (690 N-cm)
GEN3SYS	26	7495-IP15-1	8IP-15	61.0 in-lbs (690 N-cm)
GEN3SYS	29	7495-IP15-1	8IP-15	61.0 in-lbs (690 N-cm)
GEN3SYS	32	7495-IP15-1	8IP-15	61.0 in-lbs (690 N-cm)

*Tightening torques are calculated with a friction coefficient of $\mu = 0.14$ and develop 90% of ultimate yield strength



Non-stocked diameters are also available. Follow the examples shown below.

Inch	38 series, T-A (1 series), 1.6790"	Part No. = V3801D-1.6790
Metric	38 series, T-A (1 series), 42.15mm	Part No. = V3801D-42.15

IC inserts sold in multiples of 2 | Insert screws sold in multiples of 10



APX Drill Holders

63 Series | Diameter Range: 2.4803" - 2.7558" (63.00mm - 69.99mm)

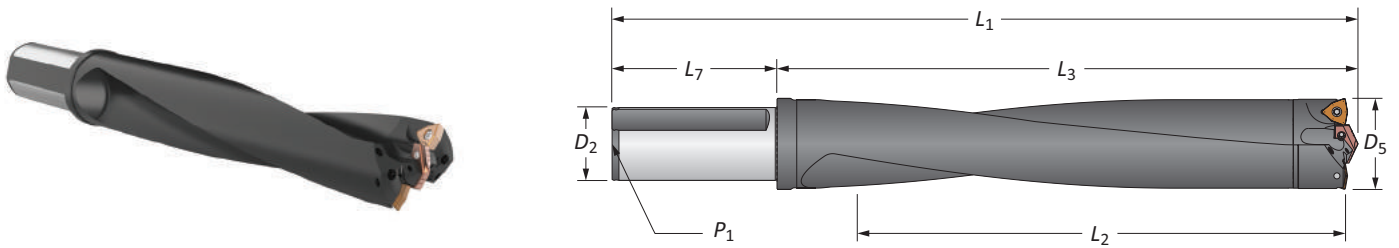

Straight Shank

	Length	D ₅	Body			Shank			Part No.
			L ₂	L ₃	L ₁	L ₇	D ₂	P ₁	
i	3xD	2.4803 - 2.7558	7-7/8	10-11/32	14-27/32	4-1/2	2	1/4	W6303H-200F
	5xD	2.4803 - 2.7558	13-3/4	15-27/32	20-11/32	4-1/2	2	1/4	W6305H-200F
	8xD	2.4803 - 2.7558	22-1/8	24-1/8	28-5/8	4-1/2	2	1/4	W6308H-200F
	10xD	2.4803 - 2.7558	27-1/8	29-11/64	33-43/64	4-1/2	2	1/4	W6310H-200F
m	3xD	63.00 - 69.99	200.8	262.6	342.6	80.0	50.0	1/4*	W6303H-50FM
	5xD	63.00 - 69.99	350.0	402.6	482.6	80.0	50.0	1/4*	W6305H-50FM
	8xD	63.00 - 69.99	560.0	612.6	692.6	80.0	50.0	1/4*	W6308H-50FM
	10xD	63.00 - 69.99	688.3	740.9	820.9	80.0	50.0	1/4*	W6310H-50FM

*Thread to BSP and ISO 7-1

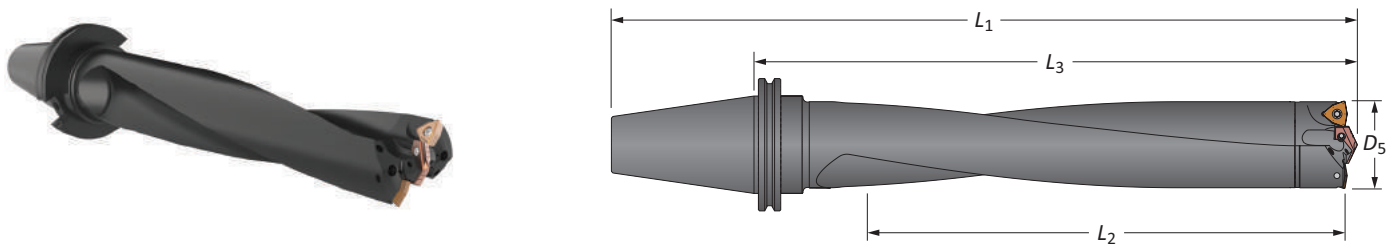

CV50 Shank

	Length	D ₅		Body			Shank	Part No.
		inch	mm	L ₂	L ₃	L ₁		
i	3xD	2.4803 - 2.7558	63.00 - 69.99	7-7/8	11-7/16	15-7/16	CV50	W6303H-CV50
	5xD	2.4803 - 2.7558	63.00 - 69.99	13-3/4	16-15/16	20-15/16	CV50	W6305H-CV50
	8xD	2.4803 - 2.7558	63.00 - 69.99	22	25-13/64	29-13/64	CV50	W6308H-CV50
	10xD	2.4803 - 2.7558	63.00 - 69.99	26-1/2	29-43/64	33-43/64	CV50	W6310H-CV50

Connection Accessories

Mounting Screw	Mounting Screw Driver	Admissible Tightening Torque*
75020-IP20-1	8IP-20	60 in-lb (678 N-cm)

*Tightening torques are calculated with a friction coefficient of $\mu = 0.14$ and develop 90% of ultimate yield strength

⚠ WARNING Refer to Speed and Feed charts for recommended adjustments to speeds and feeds. Refer to page A50: 30 for deep hole drilling guidelines in this section of the catalog. Visit www.alliedmachine.com/DeepHoleGuidelines for the most up-to-date information and procedures. Factory technical assistance is available for your specific applications through our Application Engineering Team.

i = Imperial (in)
m = Metric (mm)

Mounting screws sold in multiples of 4



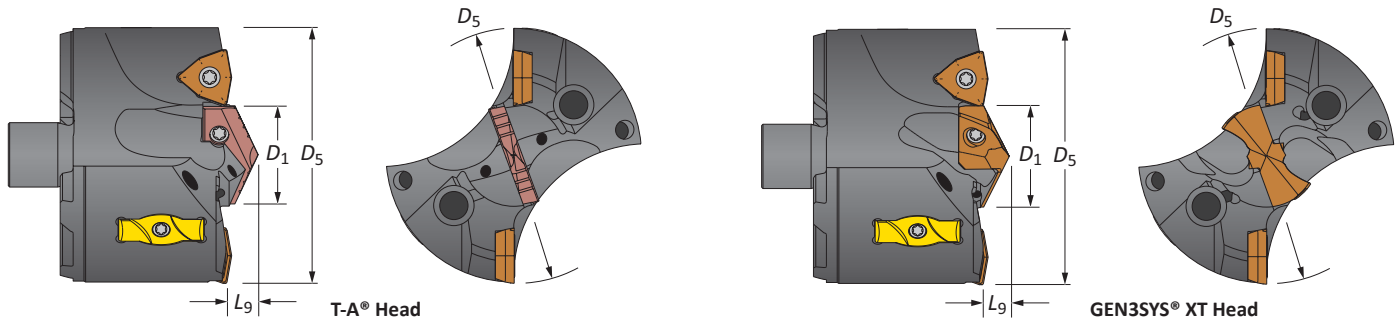

APX Drill Heads

70 Series | Diameter Range: 2.7559" - 2.9920" (70.00mm - 75.99mm)

















Heads

Head					T-A Head				GEN3SYS XT Head			
D_5 fractional	D_5 inch	D_5 mm	D_1	L_9	Part No.	Pilot Series			Part No.	Pilot Series		IC Insert Size
-	2.7559	70.00	1-7/32	25/64	V7002S-70	2	4C*2H-0107	1C12H-0107-TC	V7029S-70	29	7C*29P-0107	3/8
2-13/16	2.8125	71.44	1-7/32	25/64	V7002S-0226	2	4C*2H-0107	1C12H-0107-TC	V7029S-0226	29	7C*29P-0107	3/8
-	2.8346	72.00	1-7/32	25/64	V7002S-72	2	4C*2H-0107	1C12H-0107-TC	V7029S-72	29	7C*29P-0107	3/8
2-7/8	2.8750	73.03	1-7/32	25/64	V7002S-0228	2	4C*2H-0107	1C12H-0107-TC	V7029S-0228	29	7C*29P-0107	3/8
-	2.9134	74.00	1-7/32	25/64	V7002S-74	2	4C*2H-0107	1C12H-0107-TC	V7029S-74	29	7C*29P-0107	3/8
2-15/16	2.9375	74.61	1-7/32	25/64	V7002S-0230	2	4C*2H-0107	1C12H-0107-TC	V7029S-0230	29	7C*29P-0107	3/8



*Denotes carbide grade (1 = C1, 2 = C2)

IC Inserts

Coating	Size	Grade	Geometry		Part No.		Insert Screw		Insert Driver	Admissible Tightening Torque*
AM300®	3/8	C5 (P35)	Standard		OP-060408-PW		73595-IP15-1		8IP-15	41.0 in-lbs (465 N-cm)
AM300®	3/8	C1 (K35)	Standard		OP-060408-1PW		73595-IP15-1		8IP-15	41.0 in-lbs (465 N-cm)
AM300®	3/8	C2 (K25)	Standard		OP-060408-2PW		73595-IP15-1		8IP-15	41.0 in-lbs (465 N-cm)
AM300®	3/8	C5 (P35)	High Rake		OP-060408-PWHR		73595-IP15-1		8IP-15	41.0 in-lbs (465 N-cm)







*Tightening torques are calculated with a friction coefficient of $\mu = 0.14$ and develop 90% of ultimate yield strength

Wear Pads

	Part No.		Wear Pad Screw		Wear Pad Driver	Admissible Tightening Torque*
	WP7095		7358-IP10-1		8IP-10	27.0 in-lbs (300 N-cm)

*Tightening torques are calculated with a friction coefficient of $\mu = 0.14$ and develop 90% of ultimate yield strength

Pilot Accessories

Pilot Style	Series		Insert Screws		Insert Driver	Admissible Tightening Torque*
T-A	2		7495-IP15-1		8IP-15	61.0 in-lbs (690 N-cm)
GEN3SYS	29		7495-IP15-1		8IP-15	61.0 in-lbs (690 N-cm)

*Tightening torques are calculated with a friction coefficient of $\mu = 0.14$ and develop 90% of ultimate yield strength

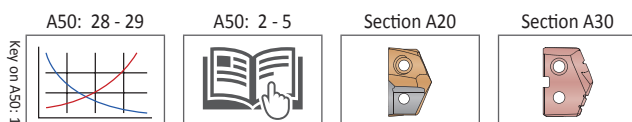

Non-stocked diameters are also available. Follow the examples shown below.

Inch	38 series, T-A (1 series), 1.6790"	Part No. = V3801D-1.6790
Metric	38 series, T-A (1 series), 42.15mm	Part No. = V3801D-42.15

Wear pads sold in multiples of 2 | Wear pad screws sold in multiples of 4
IC inserts sold in multiples of 2 | Insert screws sold in multiples of 10

APX Drill Holders

70 Series | Diameter Range: 2.7559" - 2.9920" (70.00mm - 75.99mm)

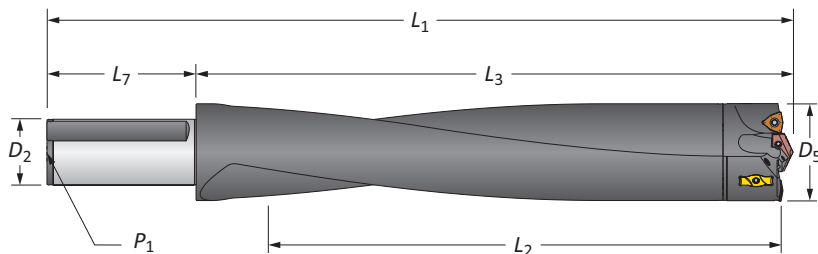

Straight Shank

	Length	D ₅	Body			Shank			Part No.
			L ₂	L ₃	L ₁	L ₇	D ₂	P ₁	
i	3xD	2.7559 - 2.9920	8-3/4	10-19/32	15-3/32	4-1/2	2	1/4	W7003H-200F
	5xD	2.7559 - 2.9920	14-7/8	16-37/64	21-5/64	4-1/2	2	1/4	W7005H-200F
	8xD	2.7559 - 2.9920	23-7/8	25-35/64	30-3/64	4-1/2	2	1/4	W7008H-200F
	10xD	2.7559 - 2.9920	27-7/8	29-35/64	34-3/64	4-1/2	2	1/4	W7010H-200F
m	3xD	70.00 - 75.99	218.8	269.0	349.0	80.0	50.0	1/4*	W7003H-50FM
	5xD	70.00 - 75.99	380.0	421.1	501.1	80.0	50.0	1/4*	W7005H-50FM
	8xD	70.00 - 75.99	608.0	649.0	729.0	80.0	50.0	1/4*	W7008H-50FM
	10xD	70.00 - 75.99	709.4	750.3	830.3	80.0	50.0	1/4*	W7010H-50FM

*Thread to BSP and ISO 7-1

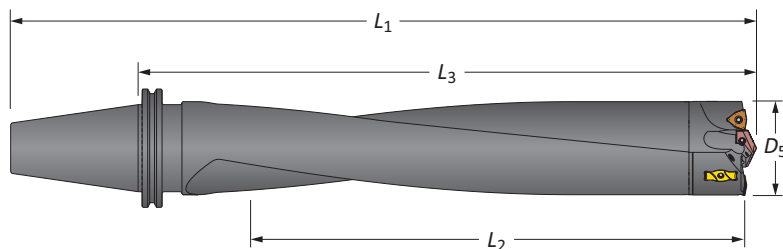

CV50 Shank

	Length	D ₅		Body			Shank	Part No.
		inch	mm	L ₂	L ₃	L ₁		
i	3xD	2.7559 - 2.9920	70.00 - 75.99	8-3/4	12-7/32	16-7/32	CV50	W7003H-CV50
	5xD	2.7559 - 2.9920	70.00 - 75.99	14-7/8	18-13/64	22-13/64	CV50	W7005H-CV50
	8xD	2.7559 - 2.9920	70.00 - 75.99	23-7/8	27-5/32	31-5/32	CV50	W7008H-CV50
	10xD	2.7559 - 2.9920	70.00 - 75.99	26-3/4	29-61/64	33-61/64	CV50	W7010H-CV50

Connection Accessories

Mounting Screw	Mounting Screw Bit	Admissible Tightening Torque*
78027-IP30-1	8IP-30B	250 in-lb (2825 N-cm)

*Tightening torques are calculated with a friction coefficient of $\mu = 0.14$ and develop 90% of ultimate yield strength

WARNING Refer to Speed and Feed charts for recommended adjustments to speeds and feeds. Refer to page A50: 30 for deep hole drilling guidelines in this section of the catalog. Visit www.alliedmachine.com/DeepHoleGuidelines for the most up-to-date information and procedures. Factory technical assistance is available for your specific applications through our Application Engineering Team.

i = Imperial (in)
m = Metric (mm)



Mounting screws sold in multiples of 4

APX Drill Heads

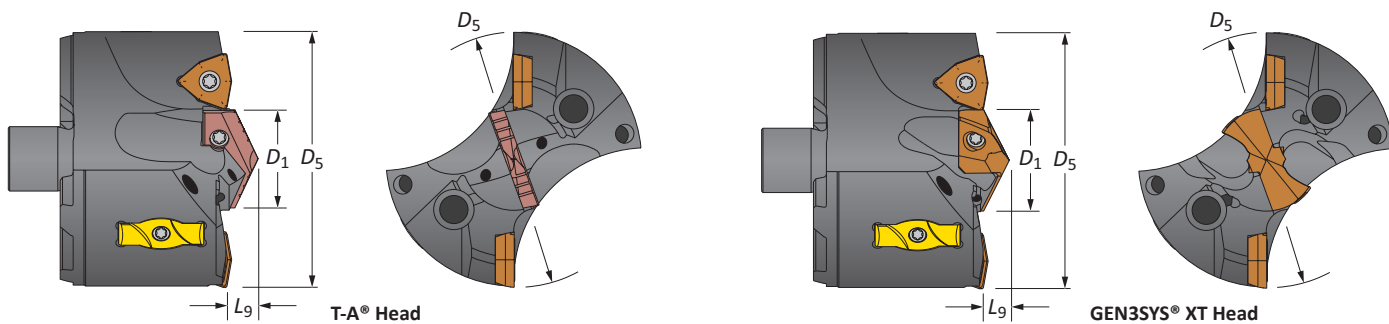
76 Series | Diameter Range: 2.9921" - 3.2676" (76.00mm - 82.99mm)





Heads

Head					T-A Head				GEN3SYS XT Head			
D_5 fractional	D_5 inch	D_5 mm	D_1	L_9	Part No.	Pilot Series			Part No.	Pilot Series		IC Insert Size
-	2.9921	76.00	1-7/32	13/32	V7602S-76	2	4C*2H-0107	1C12H-0107-TC	V7629S-76	29	7C*29P-0107	1/2
3	3.0000	76.20	1-7/32	13/32	V7602S-0300	2	4C*2H-0107	1C12H-0107-TC	V7629S-0300	29	7C*29P-0107	1/2
3-1/16	3.0625	77.79	1-7/32	13/32	V7602S-0302	2	4C*2H-0107	1C12H-0107-TC	V7629S-0302	29	7C*29P-0107	1/2
-	3.0709	78.00	1-7/32	13/32	V7602S-78	2	4C*2H-0107	1C12H-0107-TC	V7629S-78	29	7C*29P-0107	1/2
3-1/8	3.1250	79.38	1-7/32	13/32	V7602S-0304	2	4C*2H-0107	1C12H-0107-TC	V7629S-0304	29	7C*29P-0107	1/2
-	3.1496	80.00	1-7/32	13/32	V7602S-80	2	4C*2H-0107	1C12H-0107-TC	V7629S-80	29	7C*29P-0107	1/2
3-3/16	3.1875	80.96	1-7/32	13/32	V7602S-0306	2	4C*2H-0107	1C12H-0107-TC	V7629S-0306	29	7C*29P-0107	1/2
-	3.2282	82.00	1-7/32	13/32	V7602S-82	2	4C*2H-0107	1C12H-0107-TC	V7629S-82	29	7C*29P-0107	1/2
3-1/4	3.2500	82.55	1-7/32	13/32	V7602S-0308	2	4C*2H-0107	1C12H-0107-TC	V7629S-0308	29	7C*29P-0107	1/2

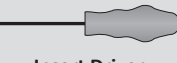

*Denotes carbide grade (1 = C1, 2 = C2)

IC Inserts

Coating	Size	Grade	Geometry	 Part No.	 Insert Screw	 Insert Driver	Admissible Tightening Torque*
AM300®	1/2	C5 (P35)	Standard	OP-080508-PW	74012-IP15-1	8IP-15	61.0 in-lbs (690 N-cm)
AM300®	1/2	C1 (K35)	Standard	OP-080508-1PW	74012-IP15-1	8IP-15	61.0 in-lbs (690 N-cm)
AM300®	1/2	C2 (K25)	Standard	OP-080508-2PW	74012-IP15-1	8IP-15	61.0 in-lbs (690 N-cm)
AM300®	1/2	C5 (P35)	High Rake	OP-080508-PWHR	74012-IP15-1	8IP-15	61.0 in-lbs (690 N-cm)



*Tightening torques are calculated with a friction coefficient of $\mu = 0.14$ and develop 90% of ultimate yield strength

Wear Pads

 Part No.	 Wear Pad Screw	 Wear Pad Driver	Admissible Tightening Torque*
WP7095	7358-IP10-1	8IP-10	27.0 in-lbs (300 N-cm)

*Tightening torques are calculated with a friction coefficient of $\mu = 0.14$ and develop 90% of ultimate yield strength

Pilot Accessories

Pilot Style	Series	 Insert Screws	 Insert Driver	Admissible Tightening Torque*
T-A	2	7495-IP15-1	8IP-15	61.0 in-lbs (690 N-cm)
GEN3SYS	29	7495-IP15-1	8IP-15	61.0 in-lbs (690 N-cm)

*Tightening torques are calculated with a friction coefficient of $\mu = 0.14$ and develop 90% of ultimate yield strength

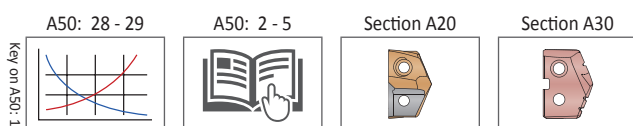

Non-stocked diameters are also available. Follow the examples shown below.

Inch	38 series, T-A (1 series), 1.6790"	Part No. = V3801D-1.6790
Metric	38 series, T-A (1 series), 42.15mm	Part No. = V3801D-42.15

Wear pads sold in multiples of 2 | Wear pad screws sold in multiples of 4
IC inserts sold in multiples of 2 | Insert screws sold in multiples of 10

APX Drill Holders

76 Series | Diameter Range: 2.9921" - 3.2676" (76.00mm - 82.99mm)

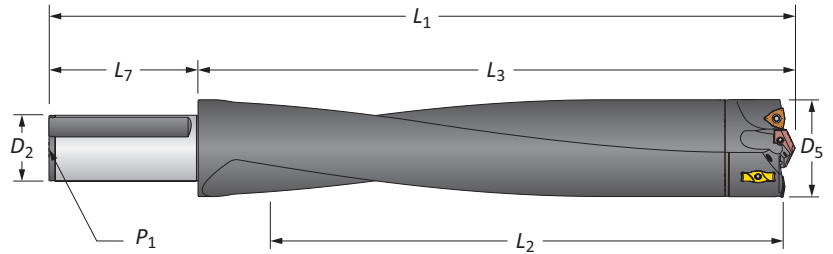

Straight Shank

Length	D ₅	Body			Shank			Part No.	
		L ₂	L ₃	L ₁	L ₇	D ₂	P ₁		
i	3xD	2.9921 - 3.2676	9-1/2	11-33/64	16-1/64	4-1/2	2	1/4	W7603H-200F
	5xD	2.9921 - 3.2676	16-3/8	18-3/64	22-35/64	4-1/2	2	1/4	W7605H-200F
	8xD	2.9921 - 3.2676	26-1/8	27-27/32	32-11/32	4-1/2	2	1/4	W7608H-200F
m	3xD	76.00 - 82.99	239.9	292.4	372.4	80.0	50.0	1/4*	W7603H-50FM
	5xD	76.00 - 82.99	415.0	458.2	538.2	80.0	50.0	1/4*	W7605H-50FM
	8xD	76.00 - 82.99	664.0	707.1	787.1	80.0	50.0	1/4*	W7608H-50FM

*Thread to BSP and ISO 7-1

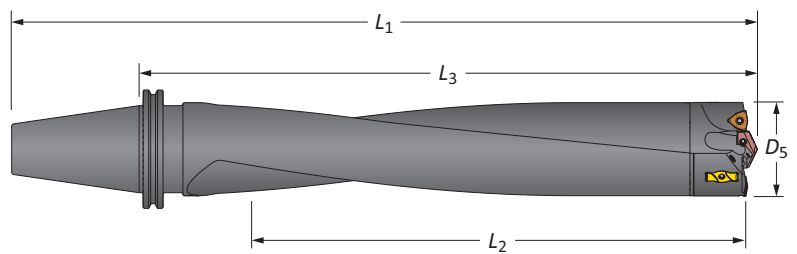

CV50 Shank

Length	D ₅		Body			Shank	Part No.	
	inch	mm	L ₂	L ₃	L ₁			
i	3xD	2.9921 - 3.2676	76.00 - 82.99	9-1/2	12-57/64	16-57/64	CV50	W7603H-CV50
	5xD	2.9921 - 3.2676	76.00 - 82.99	16-3/8	19-27/64	23-27/64	CV50	W7605H-CV50
	8xD	2.9921 - 3.2676	76.00 - 82.99	26-1/8	29-7/32	33-7/32	CV50	W7608H-CV50

Connection Accessories

Mounting Screw	Mounting Screw Bit	Admissible Tightening Torque*
78027-IP30-1	8IP-30B	250 in-lb (2825 N-cm)

*Tightening torques are calculated with a friction coefficient of $\mu = 0.14$ and develop 90% of ultimate yield strength

WARNING Refer to Speed and Feed charts for recommended adjustments to speeds and feeds. Refer to page A50: 30 for deep hole drilling guidelines in this section of the catalog. Visit www.alliedmachine.com/DeepHoleGuidelines for the most up-to-date information and procedures. Factory technical assistance is available for your specific applications through our Application Engineering Team.

i = Imperial (in)
m = Metric (mm)



Mounting screws sold in multiples of 4

APX Drill Heads

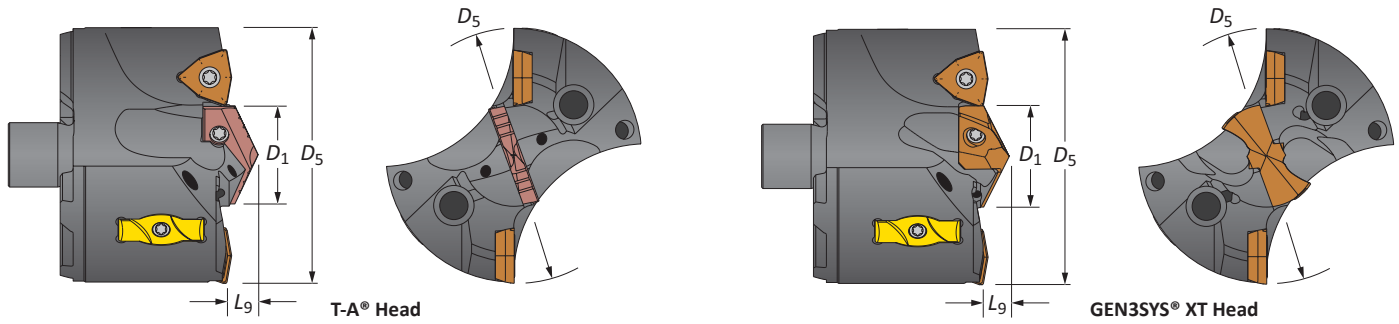
83 Series | Diameter Range: 3.2677" - 3.5038" (83.00mm - 88.99mm)





Heads

Head					T-A Head				GEN3SYS XT Head			
D_5 fractional	D_5 inch	D_5 mm	D_1	L_9	Part No.	Pilot Series			Part No.	Pilot Series		IC Insert Size
-	3.3071	84.00	1-3/8	7/16	V8302S-84	2	4C*2H-0112	1C12H-0112-TC	V8332S-84	32	7C*32P-0112	1/2
3-5/16	3.3125	84.14	1-3/8	7/16	V8302S-0310	2	4C*2H-0112	1C12H-0112-TC	V8332S-0310	32	7C*32P-0112	1/2
3-3/8	3.3750	85.73	1-3/8	7/16	V8302S-0312	2	4C*2H-0112	1C12H-0112-TC	V8332S-0312	32	7C*32P-0112	1/2
-	3.3859	86.00	1-3/8	7/16	V8302S-86	2	4C*2H-0112	1C12H-0112-TC	V8332S-86	32	7C*32P-0112	1/2
3-7/16	3.4375	87.31	1-3/8	7/16	V8302S-0314	2	4C*2H-0112	1C12H-0112-TC	V8332S-0314	32	7C*32P-0112	1/2
-	3.4646	88.00	1-3/8	7/16	V8302S-88	2	4C*2H-0112	1C12H-0112-TC	V8332S-88	32	7C*32P-0112	1/2
3-1/2	3.5000	88.90	1-3/8	7/16	V8302S-0316	2	4C*2H-0112	1C12H-0112-TC	V8332S-0316	32	7C*32P-0112	1/2



*Denotes carbide grade (1 = C1, 2 = C2)

IC Inserts

Coating	Size	Grade	Geometry	 Part No.	 Insert Screw	 Insert Driver	Admissible Tightening Torque*
AM300®	1/2	C5 (P35)	Standard	OP-080508-PW	74012-IP15-1	8IP-15	61.0 in-lbs (690 N-cm)
AM300®	1/2	C1 (K35)	Standard	OP-080508-1PW	74012-IP15-1	8IP-15	61.0 in-lbs (690 N-cm)
AM300®	1/2	C2 (K25)	Standard	OP-080508-2PW	74012-IP15-1	8IP-15	61.0 in-lbs (690 N-cm)
AM300®	1/2	C5 (P35)	High Rake	OP-080508-PWHR	74012-IP15-1	8IP-15	61.0 in-lbs (690 N-cm)



*Tightening torques are calculated with a friction coefficient of $\mu = 0.14$ and develop 90% of ultimate yield strength

Wear Pads

 Part No.	 Wear Pad Screw	 Wear Pad Driver	Admissible Tightening Torque*
WP7095	7358-IP10-1	8IP-10	27.0 in-lbs (300 N-cm)

*Tightening torques are calculated with a friction coefficient of $\mu = 0.14$ and develop 90% of ultimate yield strength

Pilot Accessories

Pilot Style	Series	 Insert Screws	 Insert Driver	Admissible Tightening Torque*
T-A	2	7495-IP15-1	8IP-15	61.0 in-lbs (690 N-cm)
GEN3SYS	32	7495-IP15-1	8IP-15	61.0 in-lbs (690 N-cm)

*Tightening torques are calculated with a friction coefficient of $\mu = 0.14$ and develop 90% of ultimate yield strength



Non-stocked diameters are also available. Follow the examples shown below.

Inch	38 series, T-A (1 series), 1.6790"	Part No. = V3801D-1.6790
Metric	38 series, T-A (1 series), 42.15mm	Part No. = V3801D-42.15

Wear pads sold in multiples of 2 | Wear pad screws sold in multiples of 4
IC inserts sold in multiples of 2 | Insert screws sold in multiples of 10

APX Drill Holders

83 Series | Diameter Range: 3.2677" - 3.5038" (83.00mm - 88.99mm)

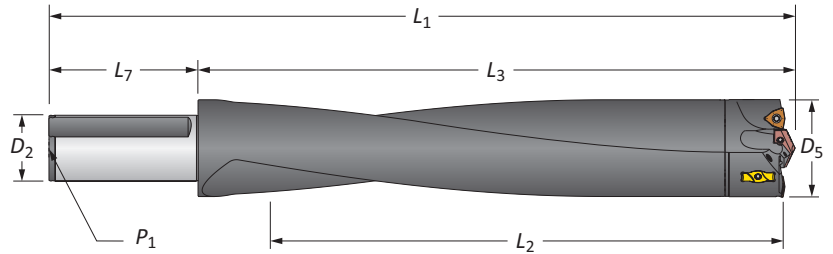

Straight Shank

	Length	D ₅		Body			Shank		Part No.	
		inch	mm	L ₂	L ₃	L ₁	L ₇	D ₂		P ₁
i	3xD	3.2677 - 3.5038	83.00 - 88.99	10-1/8	12-5/16	16-13/16	4-1/2	2	1/4	W8303H-200F
	5xD	3.2677 - 3.5038	83.00 - 88.99	17-1/2	19-5/16	23-13/16	4-1/2	2	1/4	W8305H-200F
	8xD	3.2677 - 3.5038	83.00 - 88.99	27-3/4	29-35/64	34-3/64	4-1/2	2	1/4	W8308H-200F
m	3xD	3.2677 - 3.5038	83.00 - 88.99	257.8	312.5	392.6	80.0	50.0	1/4*	W8303H-50FM
	5xD	3.2677 - 3.5038	83.00 - 88.99	445.0	490.5	570.5	80.0	50.0	1/4*	W8305H-50FM
	8xD	3.2677 - 3.5038	83.00 - 88.99	704.9	750.3	830.3	80.0	50.0	1/4*	W8308H-50FM

*Thread to BSP and ISO 7-1

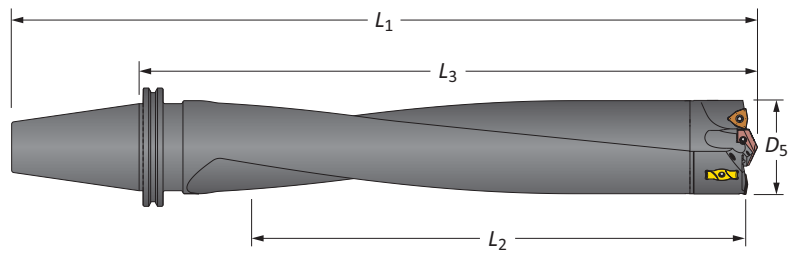

CV50 Shank

	Length	D ₅		Body			Shank	Part No.
		inch	mm	L ₂	L ₃	L ₁		
i	3xD	3.2677 - 3.5038	83.00 - 88.99	10-1/8	13-11/16	17-11/16	CV50	W8303H-CV50
	5xD	3.2677 - 3.5038	83.00 - 88.99	17-1/2	20-11/16	24-11/16	CV50	W8305H-CV50
	8xD	3.2677 - 3.5038	83.00 - 88.99	26-7/8	30-3/64	34-3/64	CV50	W8308H-CV50

Connection Accessories

Mounting Screw	Mounting Screw Bit	Admissible Tightening Torque*
78027-IP30-1	8IP-30B	250 in-lb (2825 N-cm)

*Tightening torques are calculated with a friction coefficient of $\mu = 0.14$ and develop 90% of ultimate yield strength

WARNING Refer to Speed and Feed charts for recommended adjustments to speeds and feeds. Refer to page A50: 30 for deep hole drilling guidelines in this section of the catalog. Visit www.alliedmachine.com/DeepHoleGuidelines for the most up-to-date information and procedures. Factory technical assistance is available for your specific applications through our Application Engineering Team.

i = Imperial (in)
m = Metric (mm)

Mounting screws sold in multiples of 4

APX Drill Heads

89 Series | Diameter Range: 3.5039" - 3.7401" (89.00mm - 94.99mm)

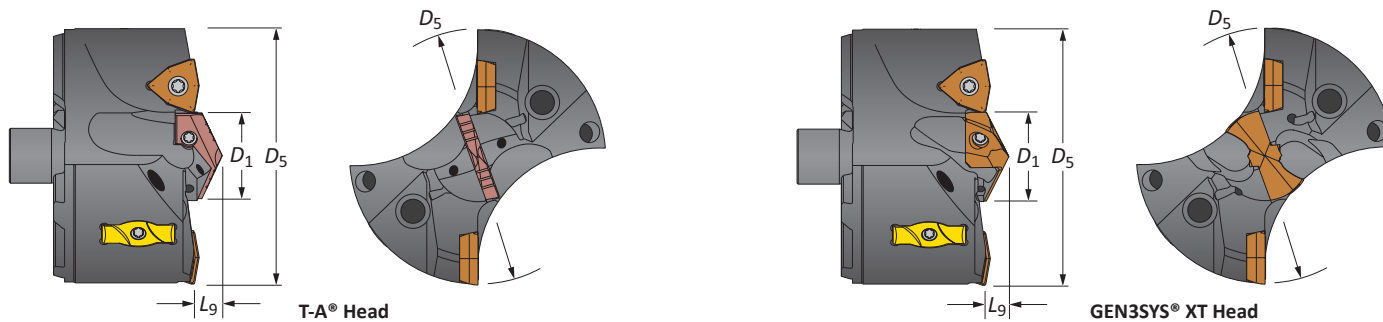

Heads

Head					T-A Head				GEN3SYS XT Head			IC Insert Size
D ₅ fractional	D ₅ inch	D ₅ mm	D ₁	L ₉	Part No.	Pilot Series	GEN2 T-A Insert	T-A (TC) Insert	Part No.	Pilot Series	Pilot Insert	
-	3.5433	90.00	1-1/4	27/64	V8902S-90	2	4C*2H-0108	1C12H-0108-TC	V8929S-90	29	7C*29P-0108	9/16
3-9/16	3.5625	90.49	1-1/4	27/64	V8902S-0318	2	4C*2H-0108	1C12H-0108-TC	V8929S-0318	29	7C*29P-0108	9/16
-	3.6220	92.00	1-1/4	27/64	V8902S-92	2	4C*2H-0108	1C12H-0108-TC	V8929S-92	29	7C*29P-0108	9/16
3-5/8	3.6250	92.08	1-1/4	27/64	V8902S-0320	2	4C*2H-0108	1C12H-0108-TC	V8929S-0320	29	7C*29P-0108	9/16
3-11/16	3.6875	93.66	1-1/4	27/64	V8902S-0322	2	4C*2H-0108	1C12H-0108-TC	V8929S-0322	29	7C*29P-0108	9/16
-	3.7008	94.00	1-1/4	27/64	V8902S-94	2	4C*2H-0108	1C12H-0108-TC	V8929S-94	29	7C*29P-0108	9/16

*Denotes carbide grade (1 = C1, 2 = C2)

IC Inserts

Coating	Size	Grade	Geometry	Part No.	Insert Screw	Insert Driver	Admissible Tightening Torque*
AM300®	9/16	C5 (P35)	Standard	OP-090608-PW	75014-IP20-1	8IP-20	121.0 in-lbs (1370 N-cm)
AM300®	9/16	C1 (K35)	Standard	OP-090608-1PW	75014-IP20-1	8IP-20	121.0 in-lbs (1370 N-cm)
AM300®	9/16	C2 (K25)	Standard	OP-090608-2PW	75014-IP20-1	8IP-20	121.0 in-lbs (1370 N-cm)
AM300®	9/16	C5 (P35)	High Rake	OP-090608-PWHR	75014-IP20-1	8IP-20	121.0 in-lbs (1370 N-cm)

*Tightening torques are calculated with a friction coefficient of $\mu = 0.14$ and develop 90% of ultimate yield strength

Wear Pads

Part No.	Wear Pad Screw	Wear Pad Driver	Admissible Tightening Torque*
WP7095	7358-IP10-1	8IP-10	27.0 in-lbs (300 N-cm)

*Tightening torques are calculated with a friction coefficient of $\mu = 0.14$ and develop 90% of ultimate yield strength

Pilot Accessories

Pilot Style	Series	Insert Screws	Insert Driver	Admissible Tightening Torque*
T-A	2	7495-IP15-1	8IP-15	61.0 in-lbs (690 N-cm)
GEN3SYS	29	7495-IP15-1	8IP-15	61.0 in-lbs (690 N-cm)

*Tightening torques are calculated with a friction coefficient of $\mu = 0.14$ and develop 90% of ultimate yield strength

A50: 28 - 29

A50: 2 - 5

Section A20

Section A30

Non-stocked diameters are also available. Follow the examples shown below.

Inch	38 series, T-A (1 series), 1.6790"	Part No. = V3801D-1.6790
Metric	38 series, T-A (1 series), 42.15mm	Part No. = V3801D-42.15

Wear pads sold in multiples of 2 | Wear pad screws sold in multiples of 4
IC inserts sold in multiples of 2 | Insert screws sold in multiples of 10

APX Drill Holders

89 Series | Diameter Range: 3.5039" - 3.7401" (89.00mm - 94.99mm)

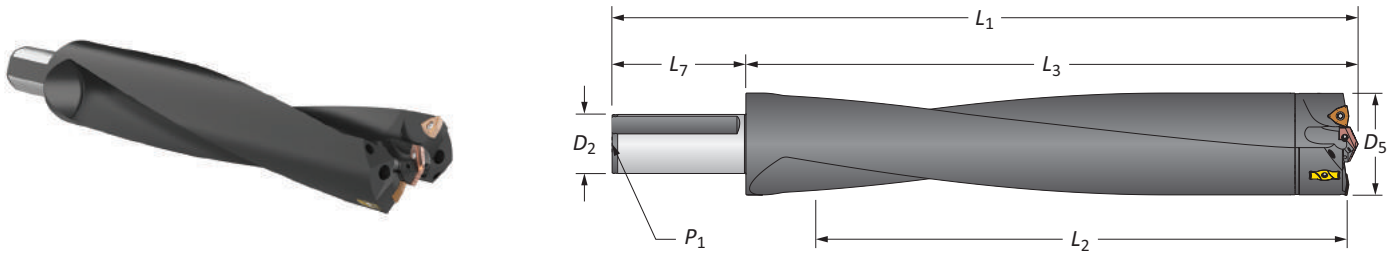

Straight Shank

	Length	D ₅	Body			Shank			Part No.
			L ₂	L ₃	L ₁	L ₇	D ₂	P ₁	
i	3xD	3.5039 - 3.7401	10-7/8	13-1/8	17-5/8	4-1/2	2	1/4	W8903H-200F
	5xD	3.5039 - 3.7401	18-5/8	20-5/8	25-1/8	4-1/2	2	1/4	W8905H-200F
	8xD	3.5039 - 3.7401	27-5/8	29-35/64	34-3/64	4-1/2	2	1/4	W8908H-200F
m	3xD	89.00 - 94.99	275.8	333.6	413.6	80.0	50.0	1/4*	W8903H-50FM
	5xD	89.00 - 94.99	475.0	523.7	603.7	80.0	50.0	1/4*	W8905H-50FM
	8xD	89.00 - 94.99	701.8	750.3	830.3	80.0	50.0	1/4*	W8908H-50FM

*Thread to BSP and ISO 7-1

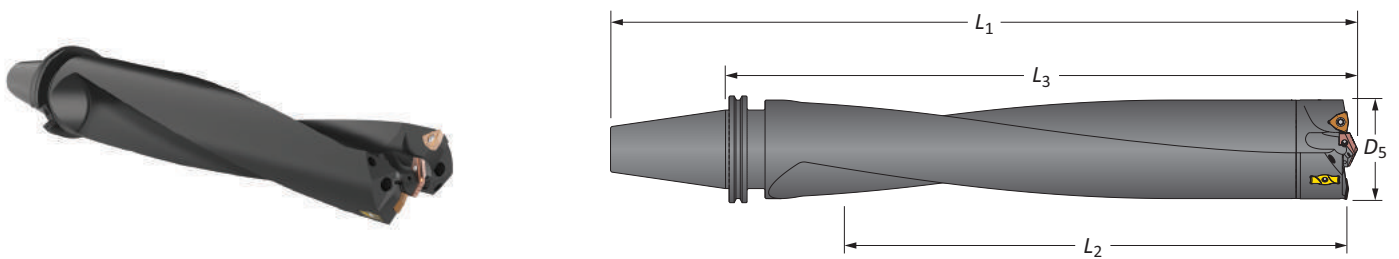

CV50 Shank

	Length	D ₅		Body			Shank	Part No.
		inch	mm	L ₂	L ₃	L ₁		
i	3xD	3.5039 - 3.7401	89.00 - 94.99	10-7/8	14-33/64	18-33/64	CV50	W8903H-CV50
	5xD	3.5039 - 3.7401	89.00 - 94.99	18-5/8	22	26	CV50	W8905H-CV50
	8xD	3.5039 - 3.7401	89.00 - 94.99	26-3/4	30-1/32	34-1/32	CV50	W8908H-CV50

Connection Accessories

Mounting Screw	Mounting Screw Bit	Admissible Tightening Torque*
78027-IP30-1	8IP-30B	250 in-lb (2825 N-cm)

*Tightening torques are calculated with a friction coefficient of $\mu = 0.14$ and develop 90% of ultimate yield strength

⚠ WARNING Refer to Speed and Feed charts for recommended adjustments to speeds and feeds. Refer to page A50: 30 for deep hole drilling guidelines in this section of the catalog. Visit www.alliedmachine.com/DeepHoleGuidelines for the most up-to-date information and procedures. Factory technical assistance is available for your specific applications through our Application Engineering Team.

i = Imperial (in)
m = Metric (mm)

Mounting screws sold in multiples of 4

APX Drill Heads

95 Series | Diameter Range: 3.7402" - 4.0000" (95.00mm - 101.60mm)

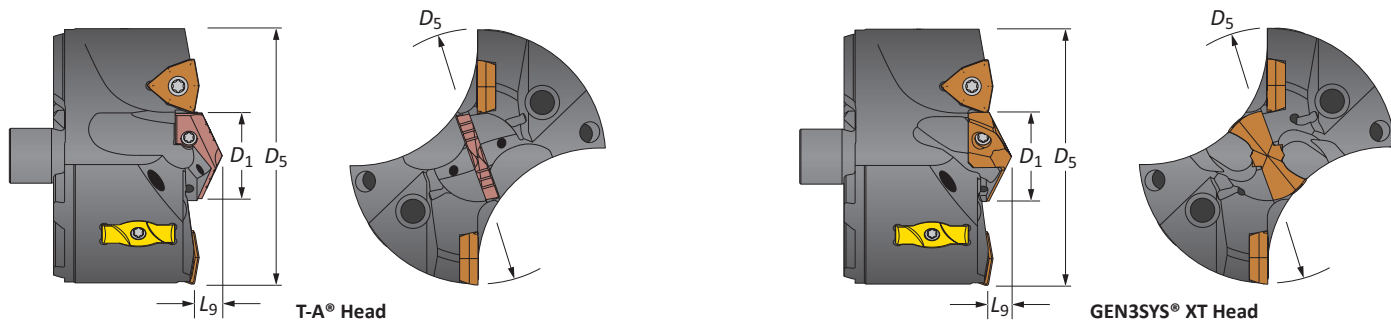

Heads

Head					T-A Head				GEN3SYS XT Head			
D ₅ fractional	D ₅ inch	D ₅ mm	D ₁	L ₉	Part No.	Pilot Series	GEN2 T-A Insert	T-A (-TC) Insert	Part No.	Pilot Series	Pilot Insert	IC Insert Size
3-3/4	3.7500	95.25	1-3/8	29/64	V9502S-0324	2	4C*2H-0112	1C12H-0112-TC	V9532S-0324	32	7C*32P-0112	9/16
-	3.7795	96.00	1-3/8	29/64	V9502S-96	2	4C*2H-0112	1C12H-0112-TC	V9532S-96	32	7C*32P-0112	9/16
3-13/16	3.8125	96.84	1-3/8	29/64	V9502S-0326	2	4C*2H-0112	1C12H-0112-TC	V9532S-0326	32	7C*32P-0112	9/16
-	3.8583	98.00	1-3/8	29/64	V9502S-98	2	4C*2H-0112	1C12H-0112-TC	V9532S-98	32	7C*32P-0112	9/16
3-7/8	3.8750	98.43	1-3/8	29/64	V9502S-0328	2	4C*2H-0112	1C12H-0112-TC	V9532S-0328	32	7C*32P-0112	9/16
-	3.9370	100.00	1-3/8	29/64	V9502S-100	2	4C*2H-0112	1C12H-0112-TC	V9532S-100	32	7C*32P-0112	9/16
3-15/16	3.9375	100.01	1-3/8	29/64	V9502S-0330	2	4C*2H-0112	1C12H-0112-TC	V9532S-0330	32	7C*32P-0112	9/16
4	4.0000	101.60	1-3/8	29/64	V9502S-0400	2	4C*2H-0112	1C12H-0112-TC	V9532S-0400	32	7C*32P-0112	9/16

*Denotes carbide grade (1 = C1, 2 = C2)

IC Inserts

Coating	Size	Grade	Geometry	Part No.	Insert Screw	Insert Driver	Admissible Tightening Torque*
AM300®	9/16	C5 (P35)	Standard	OP-090608-PW	75014-IP20-1	8IP-20	121.0 in-lbs (1370 N-cm)
AM300®	9/16	C1 (K35)	Standard	OP-090608-1PW	75014-IP20-1	8IP-20	121.0 in-lbs (1370 N-cm)
AM300®	9/16	C2 (K25)	Standard	OP-090608-2PW	75014-IP20-1	8IP-20	121.0 in-lbs (1370 N-cm)
AM300®	9/16	C5 (P35)	High Rake	OP-090608-PWHR	75014-IP20-1	8IP-20	121.0 in-lbs (1370 N-cm)

*Tightening torques are calculated with a friction coefficient of $\mu = 0.14$ and develop 90% of ultimate yield strength

Wear Pads

Part No.	Wear Pad Screw	Wear Pad Driver	Admissible Tightening Torque*
WP7095	7358-IP10-1	8IP-10	27.0 in-lbs (300 N-cm)

*Tightening torques are calculated with a friction coefficient of $\mu = 0.14$ and develop 90% of ultimate yield strength

Pilot Accessories

Pilot Style	Series	Insert Screws	Insert Driver	Admissible Tightening Torque*
T-A	2	7495-IP15-1	8IP-15	61.0 in-lbs (690 N-cm)
GEN3SYS	32	7495-IP15-1	8IP-15	61.0 in-lbs (690 N-cm)

*Tightening torques are calculated with a friction coefficient of $\mu = 0.14$ and develop 90% of ultimate yield strength

A50: 28 - 29

A50: 2 - 5

Section A20

Section A30

Key on A50: 1

Non-stocked diameters are also available. Follow the examples shown below.

Inch	38 series, T-A (1 series), 1.6790"	Part No. = V3801D-1.6790
Metric	38 series, T-A (1 series), 42.15mm	Part No. = V3801D-42.15

Wear pads sold in multiples of 2 | Wear pad screws sold in multiples of 4
IC inserts sold in multiples of 2 | Insert screws sold in multiples of 10

A DRILLING
B BORING
C REAMING
D BURISHING
E THREADING
X SPECIALS

APX Drill Holders

95 Series | Diameter Range: 3.7402" - 4.0000" (95.00mm - 101.60mm)

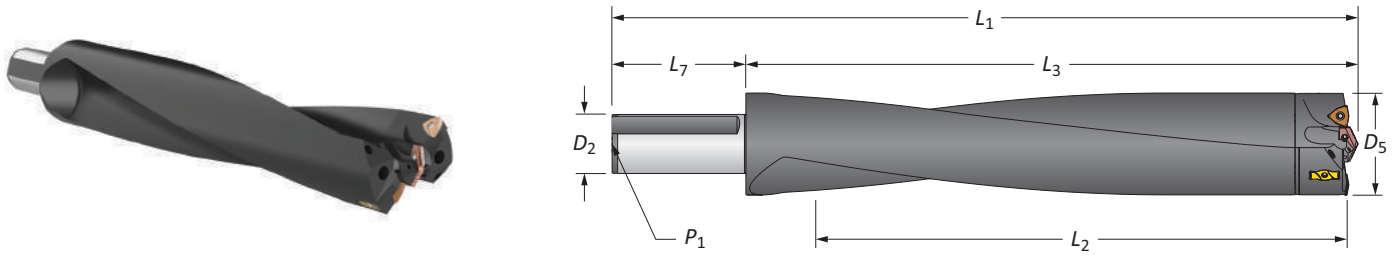

Straight Shank

Length	D ₅	Body			Shank			Part No.	
		L ₂	L ₃	L ₁	L ₇	D ₂	P ₁		
i	3xD	3.7402 - 4.0000	11-7/8	14-9/32	18-25/32	4-1/2	2	1/4	W9503H-200F
	5xD	3.7402 - 4.0000	20	22-19/64	26-51/64	4-1/2	2	1/4	W9505H-200F
	8xD	3.7401 - 4.0000	27-1/2	29-51/64	34-19/64	4-1/2	2	1/4	W9508H-200F
m	3xD	95.00 - 101.60	302.0	362.8	442.8	80.0	50.0	1/4*	W9503H-50FM
	5xD	95.00 - 101.60	508.0	566.2	646.2	80.0	50.0	1/4*	W9505H-50FM
	8xD	95.00 - 101.60	698.5	756.7	836.7	80.0	50.0	1/4*	W9508H-50FM

*Thread to BSP and ISO 7-1

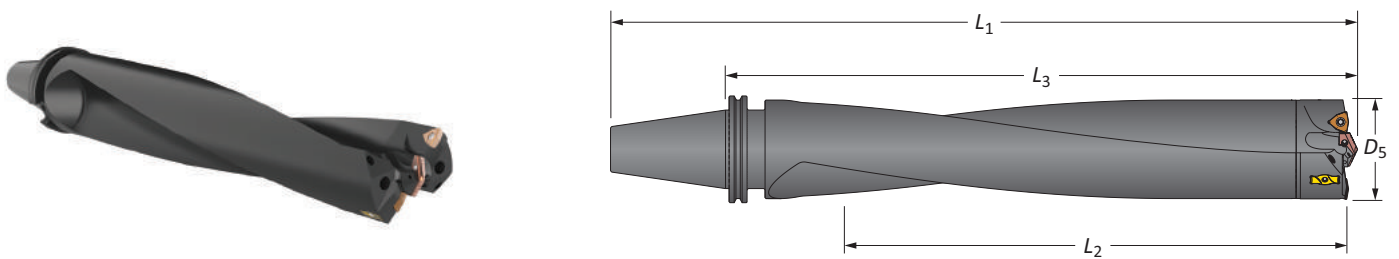

CV50 Shank

Length	D ₅		Body			Shank	Part No.	
	inch	mm	L ₂	L ₃	L ₁			
i	3xD	3.7402 - 4.0000	95.00 - 101.60	11-7/8	15-43/64	19-43/64	CV50	W9503H-CV50
	5xD	3.7402 - 4.0000	95.00 - 101.60	20	23-43/64	27-43/64	CV50	W9505H-CV50
	8xD	3.7402 - 4.0000	95.00 - 101.60	26-5/8	30-9/32	34-9/32	CV50	W9508H-CV50

Connection Accessories

Mounting Screw	Mounting Screw Bit	Admissible Tightening Torque*
78027-IP30-1	8IP-30B	250 in-lb (2825 N-cm)

*Tightening torques are calculated with a friction coefficient of $\mu = 0.14$ and develop 90% of ultimate yield strength

WARNING Refer to Speed and Feed charts for recommended adjustments to speeds and feeds. Refer to page A50: 30 for deep hole drilling guidelines in this section of the catalog. Visit www.alliedmachine.com/DeepHoleGuidelines for the most up-to-date information and procedures. Factory technical assistance is available for your specific applications through our Application Engineering Team.

i = Imperial (in)
m = Metric (mm)

Mounting screws sold in multiples of 4

Recommended Drilling Data | Imperial (inch)

ISO	Material	Hardness (BHN)	Feed Rate (IPR) by Diameter								
			Outboard Insert		5/16" IC	3/8" IC	1/2" IC	9/16" IC	3/8" IC	1/2" IC	9/16" IC
			Series	Pilot Style	33	38 - 44	44 - 51	51 - 57 - 63	70	76 - 83	89 - 95
		Speed (SFM)		1.299 - 1.495	1.496 - 1.885	1.886 - 2.210	2.211 - 2.755	2.756 - 2.992	2.992 - 3.503	3.504 - 4.000	
P	Free Machining Steel 1118, 1215, 12L14, etc.	100 - 250	450 - 750	T-A/GEN3SYS	.006 - .011	.007 - .012	.009 - .012	.009 - .012	.006 - .010	.007 - .011	.007 - .012
	Low Carbon Steel 1010, 1020, 1025, 1522, 1144, etc.	85 - 275	450 - 750	T-A/GEN3SYS	.006 - .011	.007 - .012	.009 - .012	.009 - .012	.006 - .010	.007 - .011	.007 - .012
	Medium Carbon Steel 1030, 1040, 1050, 1527, 1140, 1151, etc.	125 - 325	450 - 750	T-A/GEN3SYS	.006 - .011	.007 - .012	.009 - .012	.009 - .012	.006 - .010	.007 - .011	.007 - .012
	Alloy Steel 4140, 5140, 8640, etc.	125 - 375	400 - 700	T-A/GEN3SYS	.005 - .007	.005 - .009	.007 - .010	.007 - .011	.005 - .009	.006 - .010	.006 - .010
	High Strength Alloy 4340, 4330V, 300M, etc.	225 - 400	300 - 500	T-A/GEN3SYS	.005 - .006	.005 - .007	.005 - .008	.006 - .009	.005 - .007	.005 - .008	.006 - .008
	Structural Steel A36, A285, A516, etc.	100 - 350	450 - 750	T-A/GEN3SYS	.006 - .008	.007 - .009	.008 - .010	.009 - .011	.005 - .009	.006 - .010	.007 - .010
	Tool Steel H-13, H-21, A-4, O-2, S-3, etc.	150 - 250	300 - 500	T-A/GEN3SYS	.005 - .006	.005 - .007	.007 - .009	.008 - .010	.005 - .007	.006 - .009	.007 - .010
S	High Temp Alloy Hastelloy B, Inconel 600, etc.	140 - 310	200 - 400	T-A	.004 - .005	.004 - .007	.006 - .009	.007 - .009	.004 - .006	.005 - .007	.005 - .007
	Titanium Alloy	140 - 310	300 - 500	T-A	.005 - .007	.006 - .008	.007 - .009	.008 - .010	.004 - .006	.005 - .007	.005 - .007
	Aerospace Alloy S82	185 - 350	400 - 600	T-A/GEN3SYS	.004 - .006	.005 - .007	.006 - .008	.006 - .008	.004 - .006	.005 - .007	.005 - .007
M	Stainless Steel 400 Series 416, 420, etc.	185 - 350	300 - 500	T-A/GEN3SYS	.006 - .008	.007 - .009	.008 - .010	.009 - .011	.005 - .007	.007 - .009	.007 - .010
	Stainless Steel 300 Series 304, 316, 17-4PH, etc.	135 - 275	300 - 500	T-A/GEN3SYS	.005 - .007	.006 - .008	.007 - .009	.008 - .010	.004 - .008	.006 - .010	.006 - .010
	Super Duplex Stainless Steel	135 - 275	250 - 450	T-A/GEN3SYS	.004 - .006	.005 - .007	.007 - .009	.007 - .009	.004 - .007	.006 - .009	.007 - .010
H	Wear Plate Hardox, AR400, T-1, etc.	400 - 600	300 - 500	T-A	.003 - .005	.004 - .006	.006 - .008	.007 - .009	.003 - .005	.004 - .006	.004 - .006
	Hardened Steel	300 - 500	300 - 500	T-A	.004 - .005	.005 - .006	.006 - .008	.006 - .008	.003 - .005	.004 - .006	.004 - .006
K	Nodular, Grey, Ductile Cast Iron	120 - 320	500 - 800	T-A/GEN3SYS	.005 - .009	.006 - .010	.008 - .012	.010 - .012	.008 - .010	.009 - .011	.010 - .012
N	Cast Aluminum	30 - 180	600 - 800	T-A/GEN3SYS	.009 - .012	.010 - .014	.012 - .016	.012 - .016	.006 - .009	.008 - .011	.008 - .012
	Wrought Aluminum	30 - 180	600 - 800	T-A/GEN3SYS	.007 - .011	.008 - .012	.010 - .014	.010 - .014	.006 - .009	.008 - .011	.008 - .012
	Aluminum Bronze	100 - 250	400 - 700	T-A/GEN3SYS	.005 - .007	.005 - .008	.007 - .010	.009 - .011	.006 - .009	.007 - .010	.008 - .012
	Brass	30 - 100	800	T-A/GEN3SYS	.006 - .008	.007 - .009	.008 - .010	.009 - .012	.006 - .008	.007 - .009	.008 - .012
	Copper	60	700	T-A/GEN3SYS	.002 - .005	.003 - .006	.006 - .008	.008 - .010	.006 - .008	.006 - .008	.006 - .008

Coolant Recommendations

Series	Pressure (PSI)	Flow Rate (GPM)
33	350	10
38	300	10
44	275	12
51	250	18
57	225	20
63	200	22
70	150	25
76	100	28
83	100	30
89	100	33
95	100	33

Calculations

Value	Formula
SFM	$RPM \cdot 0.262 \cdot \text{Diameter}$
RPM	$(SFM \cdot 3.82) / \text{Diameter}$
IPM	$RPM \cdot \text{IPR}$

IMPORTANT: The speeds and feeds listed above are a general starting point for all applications. Refer to the Coolant Recommendation charts for coolant requirements to run at the recommended speeds and feeds. Factory technical assistance is also available through our Application Engineering Team.

IMPORTANT: The coolant pressure and flow rate recommendations above represent a good approximation to obtain optimum tool life and chip evacuation at Allied Machine recommended speeds and feeds. If lower coolant capabilities exist in a drilling application, the APX Drilling System will still function at reduced penetration rates. Contact our Application Engineering department for a more specific recommendation of coolant requirements and/or speeds and feeds.

⚠ WARNING Tool failure can cause serious injury. To prevent: For APX holders 8xD or longer, do not rotate tool more than 50 RPM unless it is engaged with workpiece or fixture. Refer to page A50: 30 for Deep Hole Drilling Guidelines in this section of the catalog. Visit www.alliedmachine.com/DeepHoleGuidelines for the most up-to-date information and procedures. Factory technical assistance is also available for your specific applications.

Recommended Drilling Data | Metric (mm)

ISO	Material	Hardness (BHN)	Outboard Insert		Feed Rate (mm/rev) by Diameter						
			Series		5/16" IC	3/8" IC	1/2" IC	9/16" IC	3/8" IC	1/2" IC	9/16" IC
			Speed (M/min)	Pilot Style	33.00 - 37.99	38.00 - 47.88	47.89 - 56.13	56.14 - 69.99	70.00 - 75.99	76.00 - 88.99	89.00 - 101.60
P	Free Machining Steel 1118, 1215, 12L14, etc.	100 - 250	137 - 229	T-A/GEN3SYS	0.15 - 0.28	0.18 - 0.30	0.23 - 0.30	0.23 - 0.30	0.15 - 0.25	0.18 - 0.28	0.18 - 0.30
	Low Carbon Steel 1010, 1020, 1025, 1522, 1144, etc.	85 - 275	137 - 229	T-A/GEN3SYS	0.15 - 0.28	0.18 - 0.30	0.23 - 0.30	0.23 - 0.30	0.15 - 0.25	0.18 - 0.28	0.18 - 0.30
	Medium Carbon Steel 1030, 1040, 1050, 1527, 1140, 1151, etc.	125 - 325	137 - 229	T-A/GEN3SYS	0.15 - 0.28	0.18 - 0.30	0.23 - 0.30	0.23 - 0.30	0.15 - 0.25	0.18 - 0.28	0.18 - 0.30
	Alloy Steel 4140, 5140, 8640, etc.	125 - 375	122 - 213	T-A/GEN3SYS	0.13 - 0.18	0.13 - 0.23	0.18 - 0.25	0.18 - 0.28	0.13 - 0.23	0.15 - 0.25	0.15 - 0.25
	High Strength Alloy 4340, 4330V, 300M, etc.	225 - 400	91 - 152	T-A/GEN3SYS	0.13 - 0.15	0.13 - 0.18	0.13 - 0.20	0.15 - 0.23	0.13 - 0.18	0.13 - 0.20	0.15 - 0.20
	Structural Steel A36, A285, A516, etc.	100 - 350	137 - 229	T-A/GEN3SYS	0.15 - 0.20	0.18 - 0.23	0.20 - 0.25	0.23 - 0.28	0.13 - 0.23	0.15 - 0.25	0.15 - 0.25
	Tool Steel H-13, H-21, A-4, O-2, S-3, etc.	150 - 250	91 - 152	T-A/GEN3SYS	0.13 - 0.15	0.13 - 0.18	0.18 - 0.23	0.20 - 0.25	0.13 - 0.18	0.15 - 0.23	0.18 - 0.25
S	High Temp Alloy Hastelloy B, Inconel 600, etc.	140 - 310	61 - 122	T-A	0.10 - 0.13	0.10 - 0.18	0.15 - 0.23	0.18 - 0.23	0.10 - 0.15	0.13 - 0.18	0.13 - 0.18
	Titanium Alloy	140 - 310	91 - 152	T-A	0.13 - 0.18	0.15 - 0.20	0.18 - 0.23	0.20 - 0.25	0.10 - 0.15	0.13 - 0.18	0.13 - 0.18
	Aerospace Alloy S82	185 - 350	122 - 183	T-A/GEN3SYS	0.10 - 0.15	0.13 - 0.18	0.15 - 0.20	0.15 - 0.20	0.10 - 0.15	0.13 - 0.18	0.13 - 0.18
M	Stainless Steel 400 Series 416, 420, etc.	185 - 350	91 - 152	T-A/GEN3SYS	0.15 - 0.20	0.18 - 0.23	0.20 - 0.25	0.23 - 0.28	0.13 - 0.18	0.18 - 0.23	0.18 - 0.25
	Stainless Steel 300 Series 304, 316, 17-4PH, etc.	135 - 275	91 - 152	T-A/GEN3SYS	0.13 - 0.18	0.15 - 0.20	0.18 - 0.23	0.20 - 0.25	0.10 - 0.20	0.15 - 0.25	0.15 - 0.25
	Super Duplex Stainless Steel	135 - 275	76 - 137	T-A/GEN3SYS	0.10 - 0.15	0.13 - 0.18	0.18 - 0.23	0.18 - 0.23	0.10 - 0.18	0.15 - 0.23	0.18 - 0.25
H	Wear Plate Hardox, AR400, T-1, etc.	400 - 600	91 - 152	T-A	0.07 - 0.13	0.10 - 0.15	0.15 - 0.20	0.18 - 0.23	0.08 - 0.13	0.10 - 0.15	0.10 - 0.15
	Hardened Steel	300 - 500	91 - 152	T-A	0.10 - 0.13	0.13 - 0.15	0.15 - 0.20	0.15 - 0.20	0.08 - 0.13	0.10 - 0.20	0.10 - 0.20
K	Nodular, Grey, Ductile Cast Iron	120 - 320	152 - 244	T-A/GEN3SYS	0.13 - 0.23	0.15 - 0.25	0.20 - 0.30	0.25 - 0.30	0.20 - 0.25	0.23 - 0.28	0.25 - 0.30
N	Cast Aluminum	30 - 180	183 - 244	T-A/GEN3SYS	0.23 - 0.30	0.25 - 0.36	0.30 - 0.40	0.30 - 0.40	0.15 - 0.23	0.20 - 0.28	0.20 - 0.30
	Wrought Aluminum	30 - 180	183 - 244	T-A/GEN3SYS	0.18 - 0.28	0.20 - 0.30	0.25 - 0.36	0.25 - 0.36	0.15 - 0.23	0.20 - 0.28	0.20 - 0.30
	Aluminum Bronze	100 - 250	123 - 213	T-A/GEN3SYS	0.13 - 0.18	0.13 - 0.20	0.18 - 0.25	0.23 - 0.28	0.15 - 0.23	0.18 - 0.25	0.20 - 0.30
	Brass	30 - 100	244	T-A/GEN3SYS	0.15 - 0.20	0.18 - 0.23	0.20 - 0.25	0.23 - 0.30	0.15 - 0.20	0.18 - 0.23	0.20 - 0.25
	Copper	60	213	T-A/GEN3SYS	0.05 - 0.13	0.08 - 0.15	0.15 - 0.20	0.20 - 0.25	0.08 - 0.15	0.15 - 0.20	0.15 - 0.20

Coolant Recommendations

Series	Pressure (BAR)	Flow Rate (LPM)
33	24	38
38	21	38
44	19	45
51	17	68
57	16	76
63	14	83
70	10	95
76	7	106
83	7	114
89	7	125
95	7	125

Calculations

Value	Formula
M/min	RPM • 0.003 • Diameter
RPM	(M/min • 318.47) / Diameter
mm/min	RPM • mm/rev

IMPORTANT: The speeds and feeds listed above are a general starting point for all applications. Refer to the Coolant Recommendation charts for coolant requirements to run at the recommended speeds and feeds. Factory technical assistance is also available through our Application Engineering Team.

IMPORTANT: The coolant pressure and flow rate recommendations above represent a good approximation to obtain optimum tool life and chip evacuation at Allied Machine recommended speeds and feeds. If lower coolant capabilities exist in a drilling application, the APX Drilling System will still function at reduced penetration rates. Contact our Application Engineering department for a more specific recommendation of coolant requirements and/or speeds and feeds.

⚠ WARNING Tool failure can cause serious injury. To prevent: For APX holders 8xD or longer, do not rotate tool more than 50 RPM unless it is engaged with workpiece or fixture. Refer to page A50: 30 for Deep Hole Drilling Guidelines in this section of the catalog. Visit www.alliedmachine.com/DeepHoleGuidelines for the most up-to-date information and procedures. Factory technical assistance is also available for your specific applications.

A
DRILLING
B
BORING
C
REAMING
D
BURNISHING
E
THREADING
X
SPECIALS



Deep Hole Drilling Guidelines

A

DRILLING



1. Approach
50 RPM max
12 IPM (300 mm/min)

Feed the longer drill within 1/16" (1.5mm) short of the workpiece at a **maximum of 50 RPM** and 12 IPM (300 mm/min) feed rate.

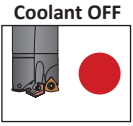
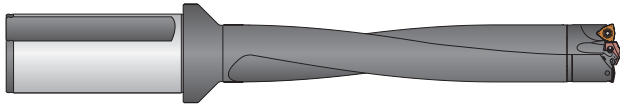

B

BORING

2. Feed-in
Speed at 75% of recommended start
Feed at 50% of recommended start

Drill 3/4" deep at 75% recommended speed and 50% recommended feed to establish the hole.

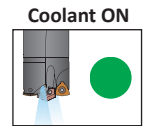
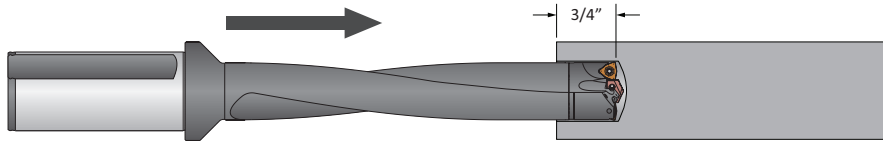

C

REAMING

3. Deep Hole Drilling - Blind
100 % RPM
100% IPR (mm/rev)

Drill to full depth at recommended speed and feed for longer drills (according to Allied Machine speed and feed charts).
***No peck cycle recommended.**

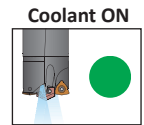
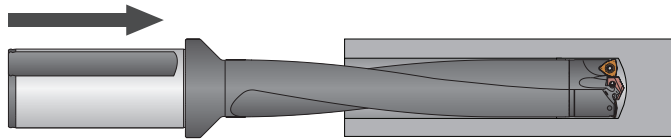

D

BURNISHING

4. Deep Hole Drilling - at Breakout
50% RPM
100% IPR (mm/rev)

***For through holes only:**
Reduce speed by 50% prior to breakout.
Do not break out more than 1/8" (3mm) past the full diameter of the drill.

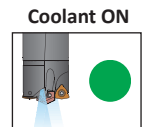
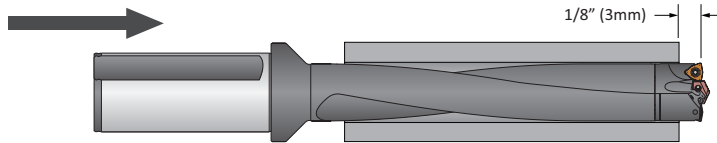

E

THREADING



5. Drill Retract
50 RPM max

Reduce speed to a **maximum of 50 RPM** before retracting from the hole.

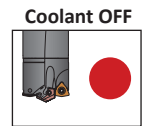
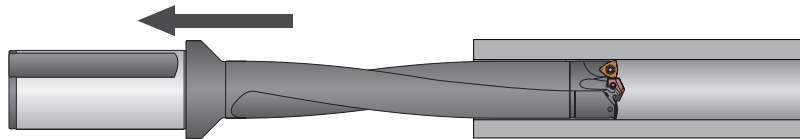

X

SPECIALS

! WARNING Tool failure can cause serious injury. To prevent: NEVER rotate these tool holders more than 50 RPM without proper engagement with a workpiece or fixture. Failure to do so could result in tool failure and/or personal injury. Visit www.alliedmachine.com/DeepHoleGuidelines for the most up-to-date information and procedures. Factory technical assistance is also available for your specific applications.

Guaranteed Test / Demo Application Form

Distributor PO # _____

The following must be filled out completely before your test will be considered

Distributor Information

Company Name: _____
 Contact: _____
 Account Number: _____
 Phone: _____
 Email: _____

End User Information

Company Name: _____
 Contact: _____
 Industry: _____
 Phone: _____
 Email: _____

Current Process List all tooling, coatings, substrates, speeds and feeds, tool life, and any problems you are experiencing

Test Objective List what would make this a successful test (i.e. penetration rate, finish, tool life, hole size, etc.)

Application Information

Hole Diameter: _____ in/mm	Tolerance: _____	Material: _____ (4150 / A36 / Cast Iron / etc.)
Required Finish: _____ RMS	_____ in/mm	Hardness: _____ (BHN / Rc)
		State: _____ (Casting / Hot rolled / Forging)

Machine Information

Machine Type: _____ (Lathe / Screw machine / Machine center / etc.)	Builder: _____ (Haas, Mori Seiki, etc.)	Model #: _____
Shank Required: _____ (CAT50 / Flanged)		Power: _____ HP/KW
Rigidity: _____	Orientation: _____	Tool Rotating: _____
<input type="checkbox"/> Excellent	<input type="checkbox"/> Vertical	<input type="checkbox"/> Yes
<input type="checkbox"/> Good	<input type="checkbox"/> Horizontal	<input type="checkbox"/> No
<input type="checkbox"/> Poor		Thrust: _____ lbs/N

Coolant Information

Coolant Delivery: _____ (Through tool / Flood)	Coolant Pressure: _____ PSI / bar
Coolant Type: _____ (Air mist, oil, synthetic, water soluble, etc.)	Coolant Volume: _____ GPM / LPM

Requested Tooling

QTY	Item Number	QTY	Item Number



Allied Machine & Engineering
 120 Deeds Drive
 Dover, OH 44622

Telephone: (330) 343-4283
 Toll Free USA & Canada: (800) 321-5537
 Fax: (330) 602-3400

Warranty Information



Allied Machine & Engineering ("Allied Machine") warrants to original equipment manufacturers, distributors, industrial and commercial users of its products for one year from the original date of sale that each new product manufactured or supplied by Allied Machine shall be free from defects in material and workmanship.

Allied Machine's sole and exclusive obligation under this warranty is limited to, at its option, without additional charge, replacing or repairing this product or issuing a credit. For this warranty to be applied, the product must be returned freight prepaid to the plant designated by an Allied Machine representative and which, upon inspection, is determined by Allied Machine to be defective in material and workmanship.

Complete information as to operating conditions, machine, setup, and the application of cutting fluid should accompany any product returned for inspection. This warranty shall not apply to any Allied Machine products which have been subjected to misuse, abuse, improper operating conditions, improper machine setup or improper application of cutting fluid or which have been repaired or altered if such repair or alteration, in the judgement of Allied Machine, would adversely affect the performance of the product.

THIS WARRANTY IS IN LIEU OF ALL OTHER WARRANTIES, EXPRESS OR IMPLIED, INCLUDING ANY IMPLIED WARRANTY OF MERCHANTABILITY OR FITNESS FOR A PARTICULAR PURPOSE. Allied Machine shall have no liability or responsibility for any claim, whether in contract, tort or otherwise, for any loss or damage arising out of, connected with, or resulting from the manufacture, sale, delivery or use of any product sold hereunder, in excess of the cost of replacement or repair as provided herein.

Allied Machine shall not be liable in contract or in tort (including, without limitation, negligence, strict liability or otherwise) for economic losses of any kind or for any special, incidental, indirect, consequential, punitive or exemplary damages arising in any way out of the performance of, or failure to perform this agreement.

ALL PRICES, DELIVERIES, DESIGNS, AND MATERIALS ARE SUBJECT TO CHANGE WITHOUT NOTICE.



Allied Machine & Engineering
Registered to ISO 9001
10001329

United States

Allied Machine & Engineering

120 Deeds Drive
Dover OH 44622
United States

Phone:
+1.330.343.4283

Fax:
+1.330.602.3400

Toll Free USA and Canada:
800.321.5537

Toll Free USA and Canada:
800.223.5140

Allied Machine & Engineering

485 W Third Street
Dover OH 44622
United States

Phone:
+1.330.343.4283

Fax:
+1.330.364.7666
(Engineering Dept.)

Toll Free USA and Canada:
800.321.5537

Europe

Allied Machine & Engineering Co. (Europe) Ltd.

93 Vantage Point
Pensnett Estate
Kingswinford
West Midlands
DY6 7FR England

Phone:
+44 (0) 1384.400900

Wohlhaupter GmbH

Maybachstrasse 4
Postfach 1264
72636 Frickenhausen
Germany

Phone:
+49 (0) 7022.408.0

Fax:
+49 (0) 7022.408.212

Asia

Wohlhaupter India Pvt. Ltd.

B-23, 2nd Floor
B Block Community Centre
Janakpuri, New Delhi - 110058
India

Phone:
+91 (0) 11.41827044

Your local Allied Machine representative:



www.alliedmachine.com

Allied Machine & Engineering is registered by DQS to ISO 9001 10001329

© 2018 Allied Machine & Engineering
Available Online Only: A50-APX
Publish Date: June 2018