



ALLIED MACHINE & ENGINEERING

Holemaking Solutions for Today's Manufacturing



Boring



Reaming



Burnishing



Threading



Specials



BT-A Drill

► *DRILLING*

BTA-STS (Single Tube System) Machining

North America

Allied Machine

120 Deeds Drive
Dover, OH 44622
United States

Allied Machine

485 West 3rd Street
Dover, OH 44622
United States

ThreadMills USA™

4185 Crosstowne Ct #B
Evans, GA 30809
United States

Superion™

1285 S Patton St.
Xenia, OH 45385
United States

Europe

Allied Machine Europe

93 Vantage Point
Pensnett Estate
Kingswinford
West Midlands
DY6 7FR, United Kingdom

Wohlhaupter® GmbH

Maybachstrasse 4
Postfach 1264
72636 Frickenhausen
Germany

Asia

Wohlhaupter® India

B-23, 2nd Floor
B Block Community Centre
Janakpuri, New Delhi - 110058
India



Allied Machine & Engineering is a worldwide leader in holmaking and finishing solutions. We are committed to providing practical and dependable solutions to our customers through innovative designs and superior customer and technical support.

We continue to expand our product offering in order to provide new and different solutions. With Field Sales Engineers located around the world, we position ourselves to provide technical support on site, right at your spindle.



ALLIED MACHINE
& ENGINEERING

www.alliedmachine.com



ALLIED MACHINE & ENGINEERING

Holemaking Solutions for Today's Manufacturing

BT-A Drill

The Foundation

Since 1941, Allied Machine & Engineering has provided dependable and practical holemaking solutions to the world. What was once a small job shop in Ohio is now a worldwide leader in cutting tool technology. With three manufacturing facilities in Ohio, one in Georgia, another in Germany, and headquarters in both the United States and Europe, Allied Machine is positioned to bring innovative solutions and technical expertise directly to the customers' hands.



The Beginning

Harold E. Stokey founded Allied Machine & Engineering to aid the war effort, manufacturing taper bearing lock nuts for the production of M1 tanks. Years later, after a sales meeting gone wrong, Stokey possessed a warehouse stocked with spade drill inserts. He set forth into the industry that would become Allied Machine's thriving identity: holemaking.



The T-A®

When Harold's son, William H. Stokey, became the president and CEO, he developed the Throw Away, or T-A, spade drill insert system. The T-A revolutionized the holemaking industry, launching Allied Machine ahead of the competition. Since then, numerous innovations and advancements have been created from the T-A's inspiration.



The Innovation

Since the development of the T-A, Allied Machine has expanded its product offering to support a vast range of customer applications, including large diameter and deep hole drilling, boring, reaming, burnishing, porting, and threading.

The People

Allied Machine understands that high quality products are only one facet of success. Our customer support is crucial to what we do, and that's why we make sure the best engineers and customer service associates are in place to assist our customers around the world.

The Future

With over 75 years of experience, Allied Machine has encountered the challenges of growth and success. By investing in cutting edge technology and the brightest and sharpest minds, our knowledge and capabilities continue to expand and grow every day.



Steve Stokey
Executive Vice President

William H. Stokey
President and CEO

Mike Stokey
Executive Vice President



WOHLHAUPTER®



SUPERION™

CRITERION™

Replaceable Insert Drills

- Reduce costs by decreasing set-up time and utilizing a single holder for the lives of multiple inserts
- Provide flexibility to quickly switch between inserts with different geometries
- Products:
 - GEN3SYS® XT | GEN3SYS® XT Pro
 - Original T-A® | GEN2 T-A®
 - High Performance | Universal



Indexable Insert Drills

- Protect your investment and reduce your inventory with replaceable cartridges that allow the same holder to be used repeatedly
- Indexable inserts increase productivity and tool life while reducing costs
- Products:
 - 4TEX® Drill
 - Revolution Drill®
 - Opening Drill®



Replaceable / Indexable Insert Drills

- Allow for higher spindle speeds and take advantage of the power curve on modern CNC machines
- Achieve maximum penetration rates in deep hole drilling applications
- Holders cover a range of sizes with the replaceable heads determining the cutting diameter
- Products:
 - APX™ Drill



Solid Carbide Drills

- Offer greater strength and stability when drilling tougher materials
- Available in diameters from 3mm - 20mm
- Can be made-to-order specifically for your application (Superion™ quoted specials)
 - ASC 320®
 - Superion™



Structural Steel Solutions



- Deliver outstanding performance and durability in structural steel applications
- Designed to produce optimal results in difficult-to-machine materials
- Available in multiple lengths and diameters
- T-A® style drills have different insert geometry options to improve performance depending on material
- Products:
 - **Original T-A®** | **GEN2 T-A®**
 - **GEN3SYS® XT Pro**

BTA (STS) Machining Solutions

- The internal ejection system flushes chips and debris from the hole with no interference to the cutting process
- Utilizes the advantages of the T-A® drill insert
- Designed to significantly increase penetration rates over brazed heads and traditional gun drills
- Products:
 - **BT-A Drill**



Hydraulic Port Contour Cutters



- Save significant time and money by performing four processes in one step
- Replaceable insert design reduces costs, inventory, and set-up times
- Available in 4 industry specifications:
 - Imperial: SAE J-1926
 - Metric: ISO 6149-1:2006
 - Military: SAE AS5202
 - John Deere: JDS-G173.1
- Products:
 - **AccuPort 432®**



Enhanced Special Drilling Capabilities

- Allied Machine Engineers are available to meet with you to evaluate your application and recommend the best solution for you
- Special drilling solutions can incorporate advanced features such as adjustable diameter locations, multiple steps, additional coolant designs, special lengths and diameters, and more
- Special drills can drastically reduce your cost-per-hole and increase your overall productivity by eliminating multiple processes and increasing tool life



WOHLHAUPTER® High Precision Boring Systems

- Designs available for high volume applications that increase rigidity to improve performance
- Versatile boring heads that are flexible with changing applications while maintaining excellent performance
- Provides high precision with absolute repeatability to ensure every part is held to tolerance
- Offers an industry leading modular shank connection that maintains rigidity and reduces inventory on your boring system
- Available with both digital and analog settings
- Products:
 - Wohlhaupter® Boring Tools



CRITERION® Modular Boring Systems

- The modular capabilities are ideal for use across multiple different projects
- Offers versatile boring heads suitable for all job shops and tooling rooms
- Provides an economical solution for low volume and/or short-term production applications
- Offers both rough and finish boring solutions
- Products:
 - Criterion® Boring Tools

S.C.A.M.I.®

Expandable Reaming Solutions

- Expandable cutting diameters accommodate for wear, which extends tool life
- Replaceable cutting heads and rings reduce waste and improve production time versus solid high speed steel and carbide reamers
- Hold tight tolerances to ensure processes are performed to accurate specifications
- Reduce tooling costs because many items are available for recondition
- Products:
 - ALVAN® Reamers



S.C.A.M.I.®

Roller Burnishing Solutions

- Produce excellent surface finishes
- Provide accurate size control
- Increase surface hardness
- Solutions for both through hole and blind hole applications
- Products:
 - S.C.A.M.I.® Roller Burnishing Tools





Solid Carbide Thread Mills

- Available with coolant through options
- Cover a wide range of thread forms
- Provide optimal solutions for both high production projects and short-run applications
- Products
 - AccuThread™ 856
 - AccuThread™ T3
 - ThreadMills USA™



Replaceable Insert Thread Mills

- 3 insert lengths are available that cover a wide range of thread forms
- Holders can utilize inserts with different pitches and thread forms
- Repeatability is achieved by both the bolt-in style and the pin style locking systems
- Increase tool life by 25 - 50% with Allied Machine's AM210® coating
- Products
 - AccuThread™ 856: Bolt-in Style
 - AccuThread™ 856: Pin Style



SPECIAL CAPABILITIES

When it comes to designing and developing special solutions for customers, Allied Machine is the top choice. If your application requires special tooling, give us a call. Our engineered specials are developed by the brightest engineers in the industry. Most of our standard tooling can be altered as specials, or we can create entirely new concepts for particularly unique applications.

One special tooling solution is Insta-Quote®, the online system that allows you to design your own special tooling 24/7. Receive a quote and drawings within minutes just by following the steps.

And with the addition of Superior™ technology and capabilities, we can customize made-to-order solid carbide tools to achieve optimal results for your applications.

Whatever your application, Allied Machine has the answer.



Insta-Quote® 

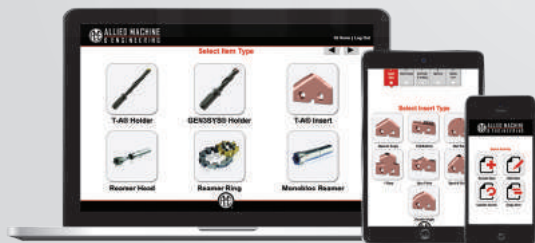

 SUPERION™



ToolMD™

Increase the production and success of your applications today.

- Offers direct access to 2D drawings and 3D models
- Assemble and view tool images in your browser
- Download drawings for use in most machining software programs
- Browse products, search item numbers, and save assemblies for future use



toolmd.com

WOHLHAUPTER® Tool-Architect

Find the right Wohlhaupter® solution for your application.

- Configure your complete tool assembly
- Compile an order list to be quoted
- Search and quickly find components using various criteria
- Adjust your language and measurement preferences



tool-architect.com

Insta-Quote®

Design your custom tooling and receive a drawing and quote...all within minutes.

- Design and quote your own tooling
- Guides you through steps to generate the solution you need
- Features the following products
 - T-A® Inserts
 - T-A® Holders
 - GEN3SYS® XT Holders
 - ALVAN® Reamers

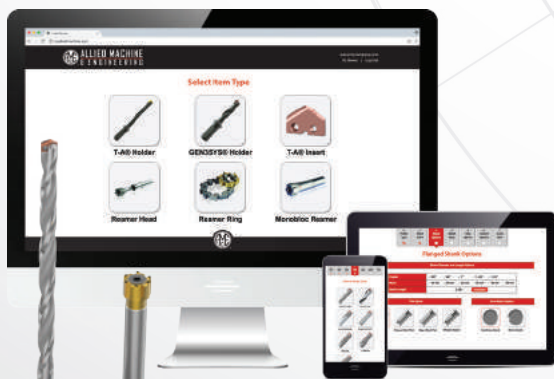

iq.alliedmachine.com

Insta-Code®

Eliminate the wait. Get your program now.

- Choose the best thread mill for your application
- Create program code for your machine
- Available as a PC download app (that can be used offline)
- Website app available 24/7



Insta-Code also has a
Cycle Time Calculator

alliedmachine.com/InstaCode

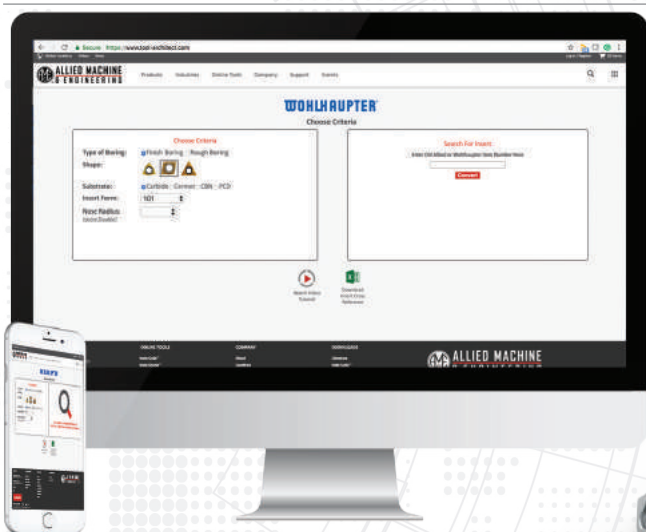

WOHLHAUPTER® Boring Insert Selector

Find the best insert for your application.

- Generate the correct boring insert for your job in just six easy steps
- Choose type, shape, substrate, insert form, nose radius, and material
- Easily order by adding the item to your cart

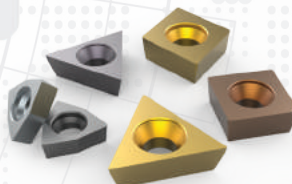

www.alliedmachine.com/bis

Product Selector

Use the product selector to find the right tool for your application.

- Guides you through steps to generate the right tool for your application
- Learn about your recommended tool and how to maximize its performance



www.alliedmachine.com/productsselector

Machinist Tool App

Quickly convert cutting tool parameters for the machine inputs you need.

- Input data to calculate the RPM and speed and feed rates
- Also features the Boring Insert Selector
- Access product literature right at your fingertips

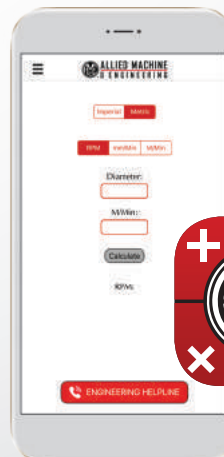

BT-A Drill

BTA (STS) Deep Hole Machining System

▶ **Diameter Range:** 0.5100" - 1.8820" (12.95mm - 47.80mm)



Material Ejection with Efficiency

The BT-A Drill (using the single tube system, or STS) conquers deep hole applications in ways other drills simply cannot. The internal ejection system flushes chips and debris from the hole with no interference to the cutting process.

By utilizing the countless advantages of the T-A® drill insert, the BT-A design significantly increases penetration rates over brazed heads and traditional gun drills. A specific BT geometry has also been developed to increase productivity in these types of drilling applications.

Excellent hole size and finish	Optimizes chip evacuation	Up to 2x the penetration rate of traditional BTA heads
--------------------------------	---------------------------	---

Applicable Industries



Your safety and the safety of others is very important. This catalog contains important safety messages. Always read and follow all safety precautions.



This triangle is a safety hazard symbol. It alerts you to potential safety hazards that can cause tool failure and serious injury.

When you see this symbol in the catalog, look for a related safety message that may be near this triangle or referred to in the nearby text.

There are safety signal words also used in the catalog. Safety messages follow these words.

WARNING

WARNING (shown above) means that failure to follow the precautions in this message could result in tool failure and serious injury.

NOTICE means that failure to follow the precautions in this message could result in damage to the tool or machine but not result in personal injury.

NOTE and **IMPORTANT** are also used. These are important that you read and follow but are not safety-related.

Visit www.alliedmachine.com for the most up-to-date information and procedures.

Reference Icons

The following icons will appear throughout the catalog to help you navigate between products.

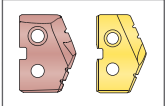

T-A® Inserts

Refers to the range of inserts that connect with the corresponding holders

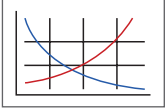

Recommended Cutting Data

Speed and feed recommendations for optimum and safe drilling

Introduction Information

System Overview	2
Product Nomenclature	3

T-A Drill Series

0 Series	4
1 Series	5
2 Series	6
3 Series	7

Series	Diameter Range	
	Imperial (inch)	Metric (mm)
0	0.5100 - 0.6959	12.95 - 17.68
1	0.6960 - 0.9600	17.69 - 24.38
2	0.9601 - 1.3800	24.39 - 35.05
3	1.3801 - 1.8820	35.06 - 47.80

System Overview

BTA Machining

BTA machining is the reverse of typical gun drilling systems. The BT-A Drill is a drill head consisting of a holder body and a replaceable tip T-A® insert. The drill head threads into an STS (single tube system) cylindrical tube with a diameter smaller than the drill head. The difference in diameter forms an annular area between the hole and the tube OD. This allows high volume coolant to be directed to the cutting edge.

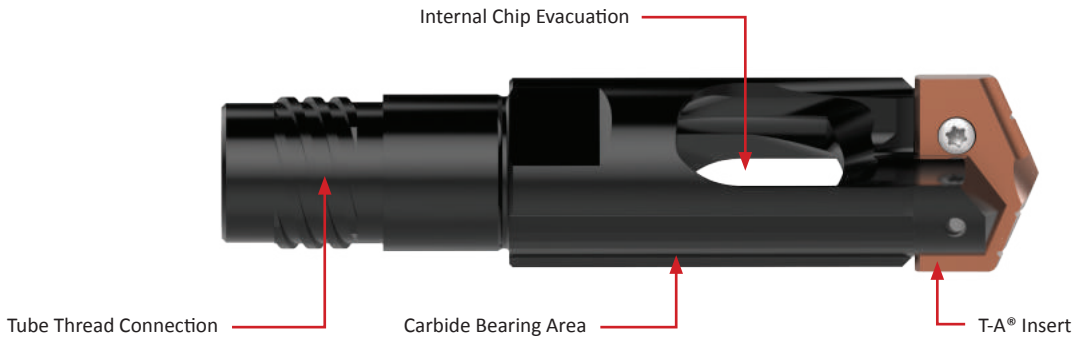

- ✓ **Improve hole straightness**
with the laser clad bearing area
- ✓ **Eliminate the need for re-sharpening**
with replaceable cutting edges
- ✓ **Reduce your inventory**
with the replaceable T-A® feature
- ✓ **Compatibility**
heads are compatible with standard BTA-STS systems
- ✓ **Balanced cutting forces**
- ✓ **Patent-pending design**

Original T-A Insert: BT-A Geometry (-BT)

- Low thrust web geometry reduces Z-axis requirements
- Tiny chip (-TC) lip geometry improves chip formation
- Polished cutting surface eliminates material build-up

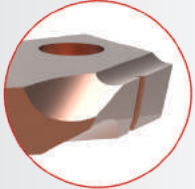

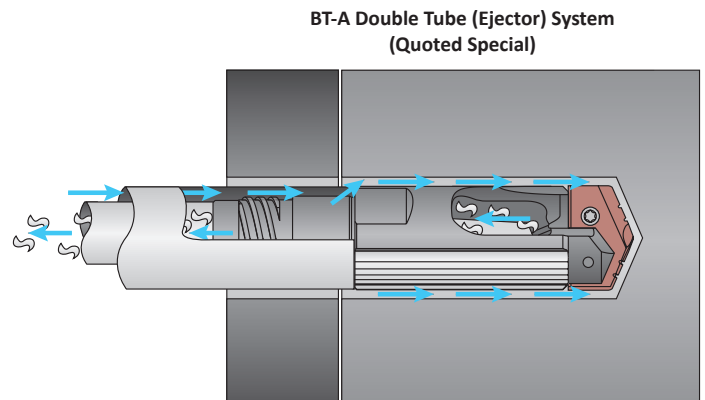
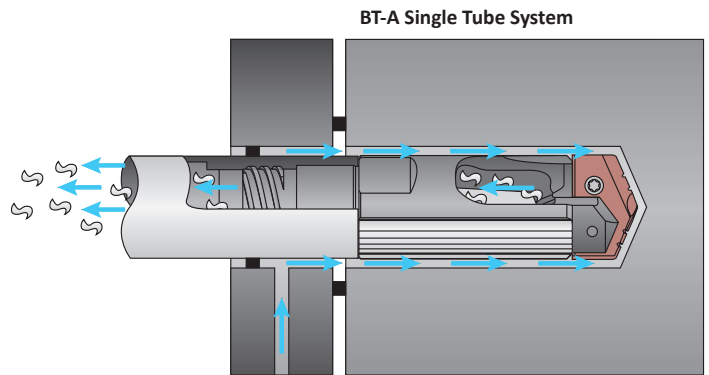

2x INCREASE in penetration rates over traditional BTA heads

Product Nomenclature

BT-A Drill Holders

BTA2	-	804	-	1.1299
1		2		3

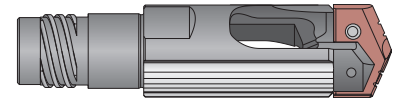

1. BT-A Drill T-A Insert Series
BTA0 = 0 series T-A insert
BTA1 = 1 series T-A insert
BTA2 = 2 series T-A insert
BTA3 = 3 series T-A insert

2. Tube Size		
794	800	806
795	801	807
796	802	808
797	803	809
798	804	810
799	805	811

3. Diameter
0.7344 = Inch
25.00 = Metric

Reference Key

Symbol	Attribute
D_1	Drill insert range
L_1	Overall length
L_3	Holder reference length
L_7	Shank length

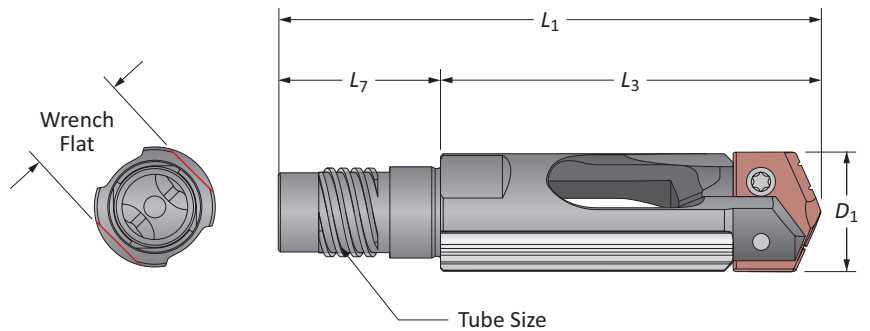

BT-A Drill Tubes

BTAT	-	804	-	63
1		2		3

1. BT-A Drill T-A Insert Series
BTAT = BT-A Tube

2. Tube Size		
794	800	806
795	801	807
796	802	808
797	803	809
798	804	810
799	805	811

3. Length
63 = Standard
102 = Long

Reference Key

Symbol	Attribute
D_1	Body diameter
ID_1	Internal diameter
L_1	Overall length

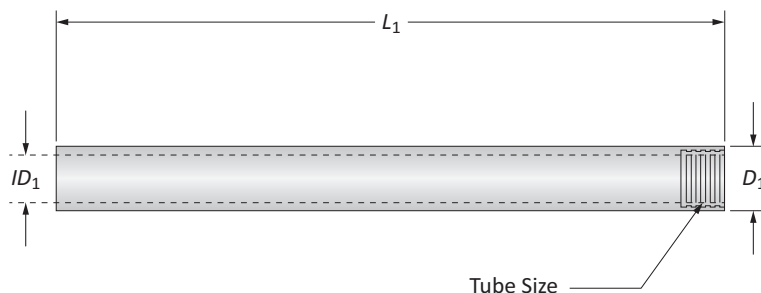



BT-A Drill Holders

0 Series | Diameter Range: 0.5100" - 0.6959" (12.95mm - 17.68mm)

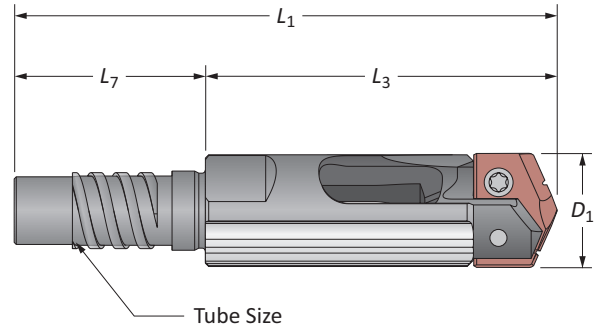
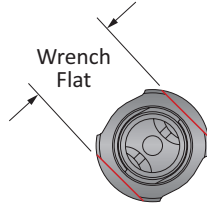
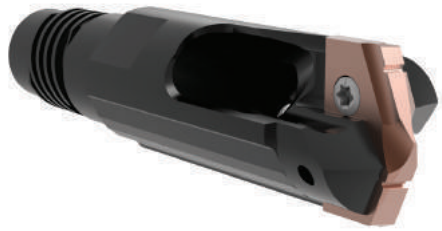

Tube Size	D_1	Holder				Part No.	 T-A® Insert	Wrench Flat (mm)
		L_3	L_1	L_7				
i	794	0.5100 - 0.5359	1-45/64	2-39/64	29/32	BTA0-794-X.XXXX	1C10H-XXXX-BT	11
	795	0.5360 - 0.5759	1-3/4	2-21/32	29/32	BTA0-795-X.XXXX	1C10H-XXXX-BT	12
	796	0.5760 - 0.6149	1-13/16	2-3/4	61/64	BTA0-796-X.XXXX	1C10H-XXXX-BT	13
	797	0.6150 - 0.6579	1-13/16	2-3/4	61/64	BTA0-797-X.XXXX	1C10H-XXXX-BT	14
	798	0.6580 - 0.6959	1-25/32	2-47/64	61/64	BTA0-798-X.XXXX	1C10H-XXXX-BT	15
m	794	12.95 - 13.61	43.4	66.4	23	BTA0-794-XX.XX	1C10H-XXXX-BT	11
	795	13.62 - 14.63	44.6	67.6	23	BTA0-795-XX.XX	1C10H-XXXX-BT	12
	796	14.64 - 15.62	45.9	69.9	24	BTA0-796-XX.XX	1C10H-XXXX-BT	13
	797	15.63 - 16.71	45.9	69.9	24	BTA0-797-XX.XX	1C10H-XXXX-BT	14
	798	16.72 - 17.68	45.3	69.3	24	BTA0-798-XX.XX	1C10H-XXXX-BT	15

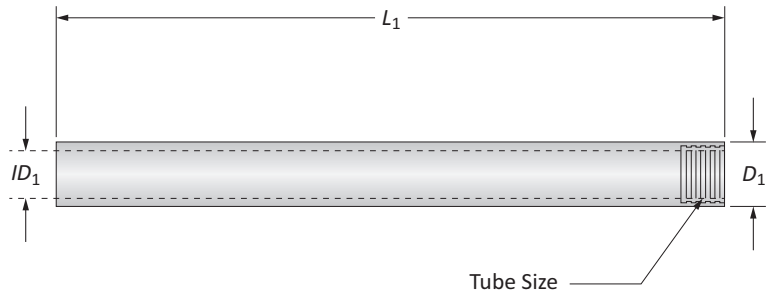

Tube Size	Tube			Part No.	
	D_1	ID_1	L_1		
i	794	0.433	0.276	63	BTAT794-63
	794	0.433	0.276	102	BTAT794-102
	795	0.472	0.315	63	BTAT795-63
	795	0.472	0.315	102	BTAT795-102
	796	0.512	0.335	63	BTAT796-63
	796	0.512	0.335	102	BTAT796-102
	797	0.551	0.354	63	BTAT797-63
	797	0.551	0.354	102	BTAT797-102
	798	0.591	0.394	63	BTAT798-63
	798	0.591	0.394	102	BTAT798-102

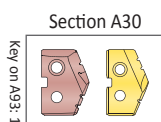

i = Imperial (in)
m = Metric (mm)

BT-A Drill Holders

1 Series | Diameter Range: 0.6960" - 0.9600" (17.69mm - 24.38mm)

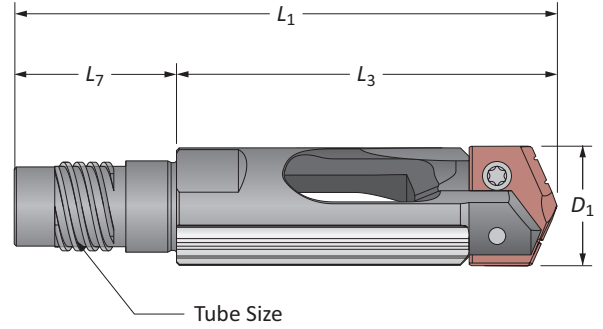
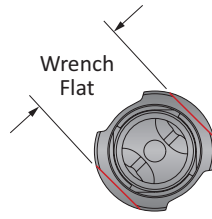

	Tube Size	D_1	Holder			Part No.	T-A® Insert	Wrench Flat (mm)
			L_3	L_1	L_7			
i	799	0.6960 - 0.7449	2-15/64	3-9/32	63/64	BTA1-799-X.XXXX	1C11H-XXXX-BT	16
	800	0.7450 - 0.7879	2-5/16	3-27/64	1-7/64	BTA1-800-X.XXXX	1C11H-XXXX-BT	17
	801	0.7880 - 0.8589	2-11/32	3-35/64	1-13/64	BTA1-801-X.XXXX	1C11H-XXXX-BT	18
	802	0.8590 - 0.9489	2-25/64	3-11/16	1-19/64	BTA1-802-X.XXXX	1C11H-XXXX-BT	19
	803	0.9490 - 0.9600	2-33/64	3-13/16	1-19/64	BTA1-803-X.XXXX	1C11H-XXXX-BT	21
m	799	17.69 - 18.92	58.2	83.2	25	BTA1-799-XX.XX	1C11H-XXXX-BT	16
	800	18.93 - 20.01	58.8	86.8	28	BTA1-800-XX.XX	1C11H-XXXX-BT	17
	801	20.02 - 21.81	59.4	89.9	30.5	BTA1-801-XX.XX	1C11H-XXXX-BT	18
	802	21.82 - 24.10	60.7	93.7	33	BTA1-802-XX.XX	1C11H-XXXX-BT	19
	803	24.11 - 24.38	63.9	96.9	33	BTA1-803-XX.XX	1C11H-XXXX-BT	21

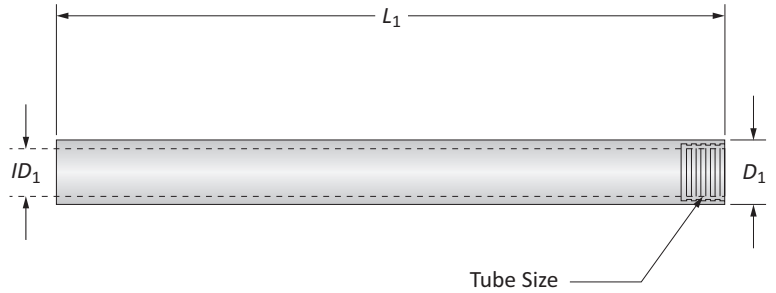

	Tube Size	Tube			Part No.
		D_1	ID_1	L_1	
i	799	0.630	0.413	63	BTAT799-63
	799	0.630	0.413	102	BTAT799-102
	800	0.669	0.453	63	BTAT800-63
	800	0.669	0.453	102	BTAT800-102
	801	0.709	0.472	63	BTAT801-63
	801	0.709	0.472	102	BTAT801-102
	802	0.787	0.512	63	BTAT802-63
	802	0.787	0.512	102	BTAT802-102
	803	0.866	0.551	63	BTAT803-63
	803	0.866	0.551	102	BTAT803-102

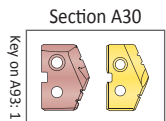

Key on A93-1

i = Imperial (in)
m = Metric (mm)

A
DRILLING
B
BORING
C
REAMING
D
BURNISHING
E
THREADING
X
SPECIALS

BT-A Drill Holders

2 Series | Diameter Range: 0.9601" - 1.3800" (24.39mm - 35.05mm)

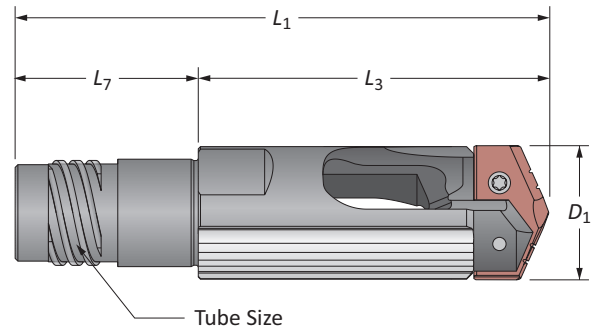
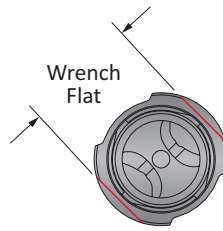
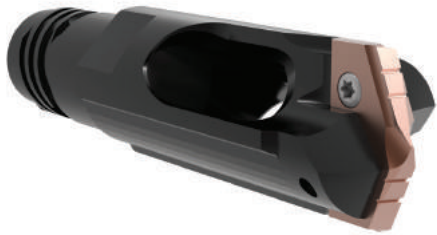

Tube Size	Holder				Part No.	 T-A® Insert	Wrench Flat (mm)	
	D_1	L_3	L_1	L_7				
i	803	0.9601 - 1.0399	3-3/32	4-25/64	1-19/64	BTA2-803-X.XXXX	1C12H-XXXX-BT	21
	804	1.0400 - 1.1299	3	4-3/32	1-7/64	BTA2-804-X.XXXX	1C12H-XXXX-BT	22
	805	1.1300 - 1.2209	2-31/32	4-25/64	1-27/64	BTA2-805-X.XXXX	1C12H-XXXX-BT	25
	806	1.2210 - 1.3119	3-1/16	4-31/64	1-27/64	BTA2-806-X.XXXX	1C12H-XXXX-BT	27
	807	1.3120 - 1.3800	3-1/16	4-31/64	1-27/64	BTA2-807-X.XXXX	1C12H-XXXX-BT	30
m	803	24.39 - 26.41	78.5	111.5	33	BTA2-803-XX.XX	1C12H-XXXX-BT	21
	804	26.42 - 28.70	75.9	103.9	28	BTA2-804-XX.XX	1C12H-XXXX-BT	22
	805	28.71 - 31.01	75.4	111.4	36	BTA2-805-XX.XX	1C12H-XXXX-BT	25
	806	31.02 - 33.32	77.9	113.8	36	BTA2-806-XX.XX	1C12H-XXXX-BT	27
	807	33.33 - 35.05	77.9	113.8	36	BTA2-807-XX.XX	1C12H-XXXX-BT	30

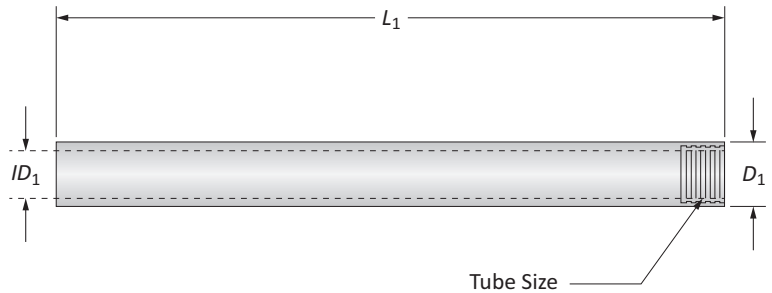

Tube Size	Tube			Part No.	
	D_1	ID_1	L_1		
i	803	0.866	0.551	63	BTAT803-63
	803	0.866	0.551	102	BTAT803-102
	804	0.945	0.610	63	BTAT804-63
	804	0.945	0.610	102	BTAT804-102
	805	1.024	0.669	63	BTAT805-63
	805	1.024	0.669	102	BTAT805-102
	806	1.102	0.728	102	BTAT806-102
807	1.181	0.787	102	BTAT807-102	

Section A30

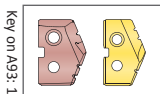

i = Imperial (in)
m = Metric (mm)

BT-A Drill Holders

3 Series | Diameter Range: 1.3801" - 1.8820" (35.06mm - 47.80mm)

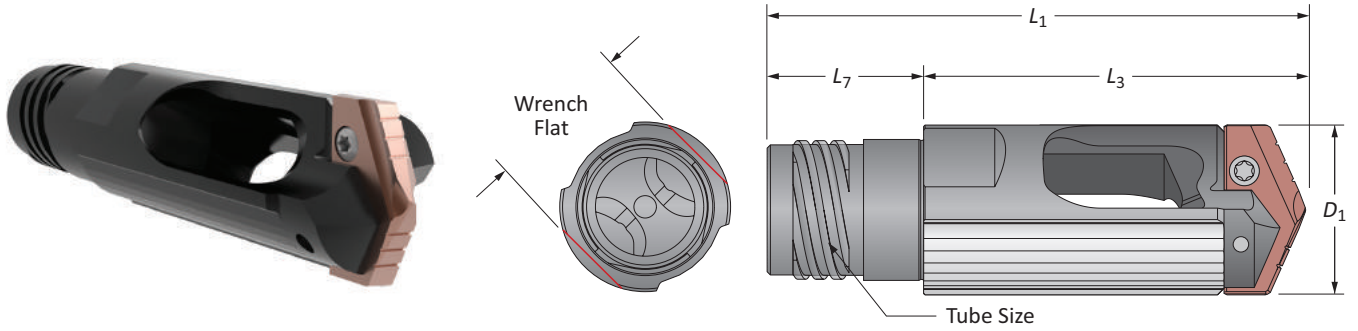

Tube Size	D_1	Holder			Part No.	T-A® Insert	Wrench Flat (mm)	
		L_3	L_1	L_7				
i	807	1.3801 - 1.4259	3-13/16	5-15/64	1-27/64	BTA3-807-X.XXXX	1C13H-XXXX-BT	30
	808	1.4260 - 1.5599	3-15/16	5-11/16	1-3/4	BTA3-808-X.XXXX	1C13H-XXXX-BT	32
	809	1.5600 - 1.6929	4-1/16	5-3/4	1-11/16	BTA3-809-X.XXXX	1C13H-XXXX-BT	36
	810	1.6930 - 1.8509	4-1/64	5-45/64	1-11/16	BTA3-810-X.XXXX	1C13H-XXXX-BT	41
	811	1.8510 - 1.8820	4-1/16	5-3/4	1-11/16	BTA3-811-X.XXXX	1C13H-XXXX-BT	41
m	807	35.06 - 36.22	96.8	132.8	36	BTA3-807-XX.XX	1C13H-XXXX-BT	30
	808	36.23 - 39.62	100.0	144.4	44.5	BTA3-808-XX.XX	1C13H-XXXX-BT	32
	809	39.63 - 43.00	103.1	146.2	43	BTA3-809-XX.XX	1C13H-XXXX-BT	36
	810	43.01 - 47.01	101.9	144.9	43	BTA3-810-XX.XX	1C13H-XXXX-BT	41
	811	47.02 - 47.80	103.2	146.2	43	BTA3-811-XX.XX	1C13H-XXXX-BT	41

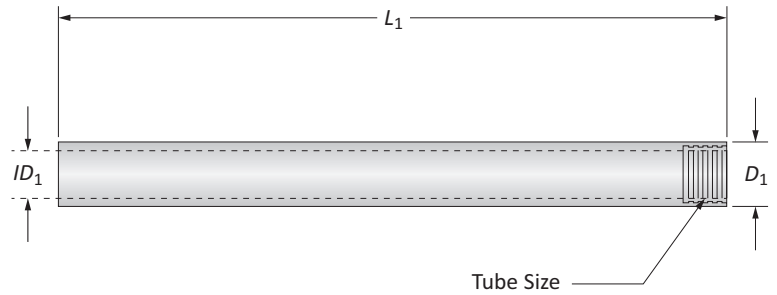

Tube Size	Tube			Part No.	
	D_1	ID_1	L_1		
i	807	1.181	0.787	102	BTAT807-102
	808	1.299	0.906	102	BTAT808-102
	809	1.417	0.984	102	BTAT809-102
	810	1.535	1.102	102	BTAT810-102
	811	1.693	1.220	102	BTAT811-102

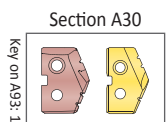

i = Imperial (in)
m = Metric (mm)

A DRILLING
B BORING
C REAMING
D BURNISHING
E THREADING
X SPECIALS

Guaranteed Test / Demo Application Form

Distributor PO # _____

The following must be filled out completely before your test will be considered

Distributor Information

Company Name: _____
 Contact: _____
 Account Number: _____
 Phone: _____
 Email: _____

End User Information

Company Name: _____
 Contact: _____
 Industry: _____
 Phone: _____
 Email: _____

Current Process List all tooling, coatings, substrates, speeds and feeds, tool life, and any problems you are experiencing

Test Objective List what would make this a successful test (i.e. penetration rate, finish, tool life, hole size, etc.)

Application Information

Hole Diameter: _____ in/mm	Tolerance: _____	Material: _____ (4150 / A36 / Cast Iron / etc.)
Pre-existing Diameter: _____ in/mm	Depth of Cut: _____ in/mm	Hardness: _____ (BHN / Rc)
Required Finish: _____ RMS	State: _____ (Casting / Hot rolled / Forging)	

Machine Information

Machine Type: _____ (Lathe / Screw machine / Machine center / etc.)	Builder: _____ (Haas, Mori Seiki, etc.)	Model #: _____
Shank Required: _____ (CAT50 / Morse taper, etc.)		Power: _____ HP/KW
Rigidity: _____	Orientation: _____	Tool Rotating: _____
<input type="checkbox"/> Excellent	<input type="checkbox"/> Vertical	<input type="checkbox"/> Yes
<input type="checkbox"/> Good	<input type="checkbox"/> Horizontal	<input type="checkbox"/> No
<input type="checkbox"/> Poor		Thrust: _____ lbs/N

Coolant Information

Coolant Delivery: _____ (Through tool / Flood)	Coolant Pressure: _____ PSI / bar
Coolant Type: _____ (Air mist, oil, synthetic, water soluble, etc.)	Coolant Volume: _____ GPM / LPM

Requested Tooling

QTY	Item Number	QTY	Item Number



ALLIED MACHINE & ENGINEERING

Allied Machine & Engineering
 120 Deeds Drive
 Dover, OH 44622

Telephone: (330) 343-4283
 Toll Free USA & Canada: (800) 321-5537
 Fax: (330) 602-3400

Warranty Information



Allied Machine & Engineering ("Allied Machine") warrants to original equipment manufacturers, distributors, industrial and commercial users of its products for one year from the original date of sale that each new product manufactured or supplied by Allied Machine shall be free from defects in material and workmanship.

Allied Machine's sole and exclusive obligation under this warranty is limited to, at its option, without additional charge, replacing or repairing this product or issuing a credit. For this warranty to be applied, the product must be returned freight prepaid to the plant designated by an Allied Machine representative and which, upon inspection, is determined by Allied Machine to be defective in material and workmanship.

Complete information as to operating conditions, machine, setup, and the application of cutting fluid should accompany any product returned for inspection. This warranty shall not apply to any Allied Machine products which have been subjected to misuse, abuse, improper operating conditions, improper machine setup or improper application of cutting fluid or which have been repaired or altered if such repair or alteration, in the judgement of Allied Machine, would adversely affect the performance of the product.

THIS WARRANTY IS IN LIEU OF ALL OTHER WARRANTIES, EXPRESS OR IMPLIED, INCLUDING ANY IMPLIED WARRANTY OF MERCHANTABILITY OR FITNESS FOR A PARTICULAR PURPOSE. Allied Machine shall have no liability or responsibility for any claim, whether in contract, tort or otherwise, for any loss or damage arising out of, connected with, or resulting from the manufacture, sale, delivery or use of any product sold hereunder, in excess of the cost of replacement or repair as provided herein.

Allied Machine shall not be liable in contract or in tort (including, without limitation, negligence, strict liability or otherwise) for economic losses of any kind or for any special, incidental, indirect, consequential, punitive or exemplary damages arising in any way out of the performance of, or failure to perform this agreement.

ALL PRICES, DELIVERIES, DESIGNS, AND MATERIALS ARE SUBJECT TO CHANGE WITHOUT NOTICE.



Allied Machine & Engineering
Registered to ISO 9001
10001329

United States

Allied Machine & Engineering

120 Deeds Drive
Dover OH 44622
United States

Phone:
+1.330.343.4283

Fax:
+1.330.602.3400

Toll Free USA and Canada:
800.321.5537

Toll Free USA and Canada:
800.223.5140

Allied Machine & Engineering

485 W Third Street
Dover OH 44622
United States

Phone:
+1.330.343.4283

Fax:
+1.330.364.7666
(Engineering Dept.)

Toll Free USA and Canada:
800.321.5537

Europe

Allied Machine & Engineering Co. (Europe) Ltd.

93 Vantage Point
Pensnett Estate
Kingswinford
West Midlands
DY6 7FR England

Phone:
+44 (0) 1384.400900

Wohlhaupter GmbH

Maybachstrasse 4
Postfach 1264
72636 Frickenhausen
Germany

Phone:
+49 (0) 7022.408.0

Fax:
+49 (0) 7022.408.212

Asia

Wohlhaupter India Pvt. Ltd.

B-23, 2nd Floor
B Block Community Centre
Janakpuri, New Delhi - 110058
India

Phone:
+91 (0) 11.41827044

Your local Allied Machine representative:

www.alliedmachine.com

Allied Machine & Engineering is registered by DQS to ISO 9001 10001329



© 2018 Allied Machine & Engineering
Available Online Only: A93-BTA
Publish Date: June 2018